

PRECISION
LIQUID HANDLING SYSTEMS

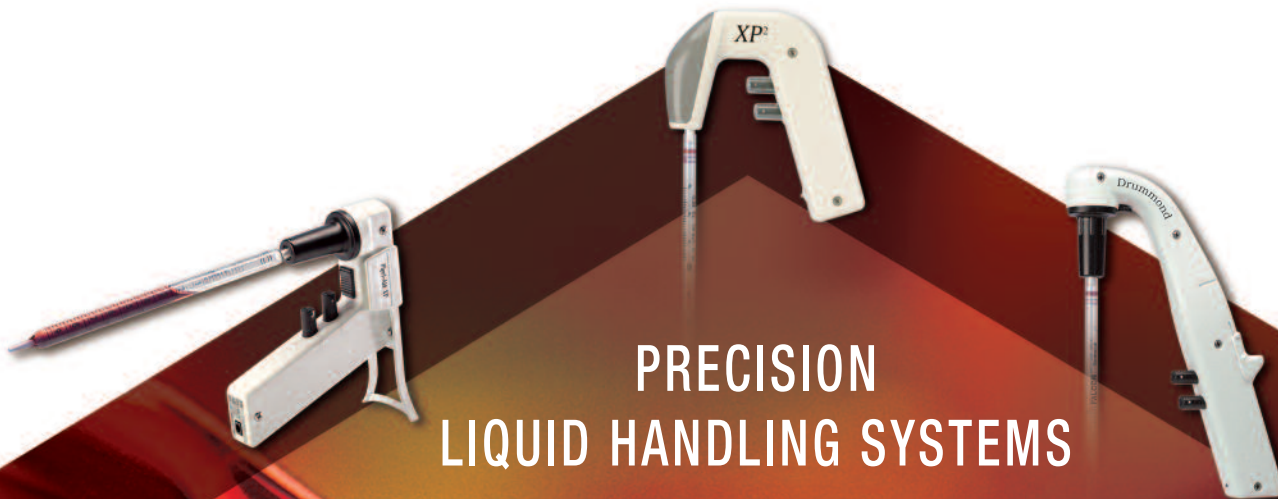

Contents



- EZ Grip Tissue Culture Nosepiece3
- Portable Pipet-Aid® XP24
- Portable Pipet-Aid® XL5
- Portable Pipet-Aid® XP6
- Original Portable Pipet-Aid®7
- Pipet-Aid® Hood Mate®8
- Original Pipet-Aid®9
- Pipet-Aid® Dual Pump Filtration Unit9



- Nanoject II™ Auto-Nanoliter Injector10
- Recording Nanoject II™11
- Nanoject II™ Accessories12
- Manual Oocyte Microinjection Pipet13
- Sequencing Pipet13



- Positive Displacement Digital Microdispensers14
- Manifolds for Microtest Plates15
- Repeat Kit with Valve15
- Dialomatic Microdispensers16
- Microdispenser Accessories and Replacement Parts16
- Fixed Volume Microdispensers17



- Aqua-Cap® Microdispensers18
- Collection Tubes18
- OEM Glass and Plastic Capillary Tubing18
- Calibrated Micropipets19
- Captrol III®19
- Wiretrol® I20
- Wiretrol® II20
- Microcaps®21
- PCR Pipets21



- HEMATO-CLAD® Tubes22
- Plasticrit Plastic Hematocrit Tubes22
- Ordering Information23

Drummond Pipet-Aids for All Reasons



Drummond Scientific pioneered the development of electronically controlled pipettors. The original Pipet-Aid created a new level of safety in the laboratory by eliminating the need for mouth pipetting. Over the years we have responded to the needs of our customers with superior service and new designs that offer performance and ergonomic features to make the job easier, safer, and more productive.

EZ Grip Tissue Culture Nosepiece

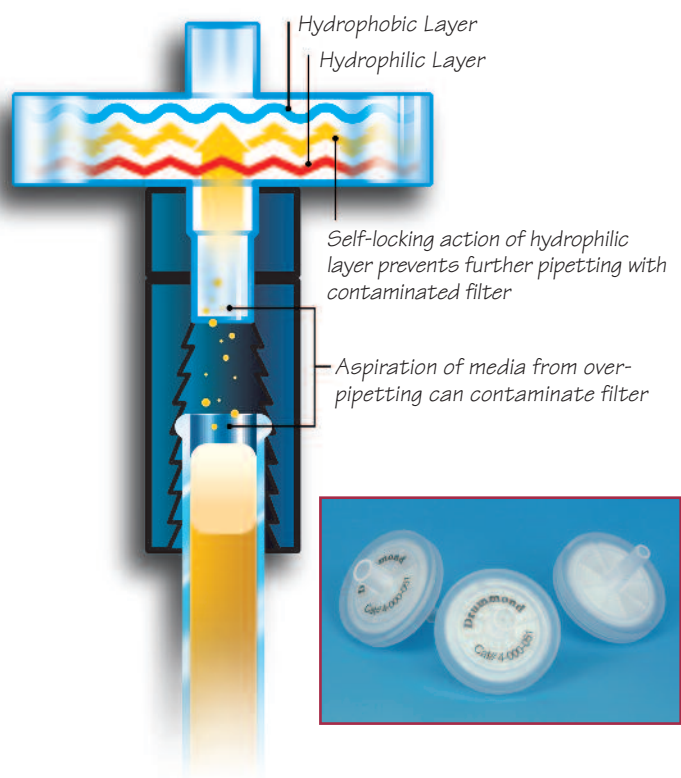

The Drummond EZ Grip Tissue Culture Nosepiece eliminates the possibility of cross-contamination due to over-pipetting. It incorporates a dual hydrophilic 0.8 μm , hydrophobic 0.8 μm filter which prevents further use once contaminated by fluid. This double membrane filter provides a barrier to particles as small as 0.1 μm . Each kit contains all necessary parts including four filters. Extra filters may be ordered separately.

EZ Grip Colored Nosepiece Housings for XP, XL, and Hood Mate®

Cat. No.	Description
4-000-050	EZ Grip TC Nosepiece Kit with four Self-locking Filters
4-000-051	Self-locking TC Filter 5/pk
4-000-051-S	Sterile Self-locking TC Filter 5/pk
4-000-052	Self-locking TC Filter 50/pk
4-000-052-S	Sterile Self-locking TC Filter 50/pk
4-000-087	EZ Grip TC Nosepiece Kit with four Self-locking Filters for XP, XL, and Hood Mate

Cat. No.	Description	Pack
4-000-079	EZ Grip Nosepiece TC Filter Housing, Black	1
4-000-079-B	EZ Grip Nosepiece TC Filter Housing, Blue	2
4-000-079-G	EZ Grip Nosepiece TC Filter Housing, Green	2
4-000-079-O	EZ Grip Nosepiece TC Filter Housing, Orange	2
4-000-079-R	EZ Grip Nosepiece TC Filter Housing, Red	2
4-000-079-V	EZ Grip Nosepiece TC Filter Housing, Violet	2
4-000-079-W	EZ Grip Nosepiece TC Filter Housing, White	1
4-000-079-Y	EZ Grip Nosepiece TC Filter Housing, Yellow	2
4-000-079-Z	EZ Grip Nosepiece TC Filter Housing, (Assorted)	6

Portable Pipet-Aid® XP2

The Evolution of Xcellence Continues

- New Ergonomic Design—The most comfortable pipettor you ever laid a hand on
- New Power Source for Uninterrupted Extended Operation—Can be charged while in use
- New Ultra Quiet Precision Pump—Great control for aspiration or dispensing

The new Drummond Pipet-Aid XP2 advances the industry standards for pipetting **comfort**, **convenience**, and **control**. Building on the years of experience of providing state-of-the-art tools that make your job in the laboratory safer, easier, and more convenient, the Pipet-Aid XP2 delivers more. The ergonomic design is more comfortable to handle. The new power source enables more convenient extended operation and the new more powerful pump provides great control and quieter operations. The unit is supplied complete with a power supply/charger, 4 extra filters, and a removable stand.

Specifications

Size 5.5"
 Weight 7.8 oz.
 Capacity Accepts 1 to 100 mL pipets
 Battery Ni-MH (3.6V/700 mAh)

Cat. No.	Description
4-000-501	Pipet-Aid XP2, 110V
4-000-501-A	Pipet-Aid XP2, 240V, Australia
4-000-501-I	Pipet-Aid XP2, 240V, CE, International
4-000-501-UK	Pipet-Aid XP2, 230V, CE, UK

Replacement Parts

Cat. No.	Description
4-000-520	(1) Nosepiece Cover
4-000-522	(2) Filter Lock
4-000-523	(3) Handle Shell
4-000-524	(4) Filter Connector
4-000-051	(5) Self-locking TC Filter 5/pk
4-000-051-S	Sterile Self-locking TC Filter 5/pk
4-000-052	Sterile Self-locking TC Filter 50/pk
4-000-052-S	Sterile Self-locking TC Filter 50/pk
4-000-002	(6) Rubber Insert
4-000-525	(7) Button Assembly
4-000-528	(8) XP2 Valve Body Complete w/Buttons
4-000-072	(9) Switch Operator, XP/XL/XP2
	(10) Valve Body Slide (yellow) comes with Valve Body
4-000-561	(11) XP2 Pump, Board, Wire Harness, Micro Switch with Connecting Tubing
4-000-526	(12) XP2 Removable Stand
4-000-527	(13) Front Cover Hold-down Clip
4-000-036	Replacement Ni-MH Battery
4-000-065	Not Shown XP2 Power Supply 110V, 6 VDC/200 mA
4-000-066	Not Shown XP2 Power Supply 240V, CE, Euro
4-000-066-A	Not Shown XP2 Power Supply 240V, Australia
4-000-066-E	Not Shown XP2 Power Supply 230V, CE, UK

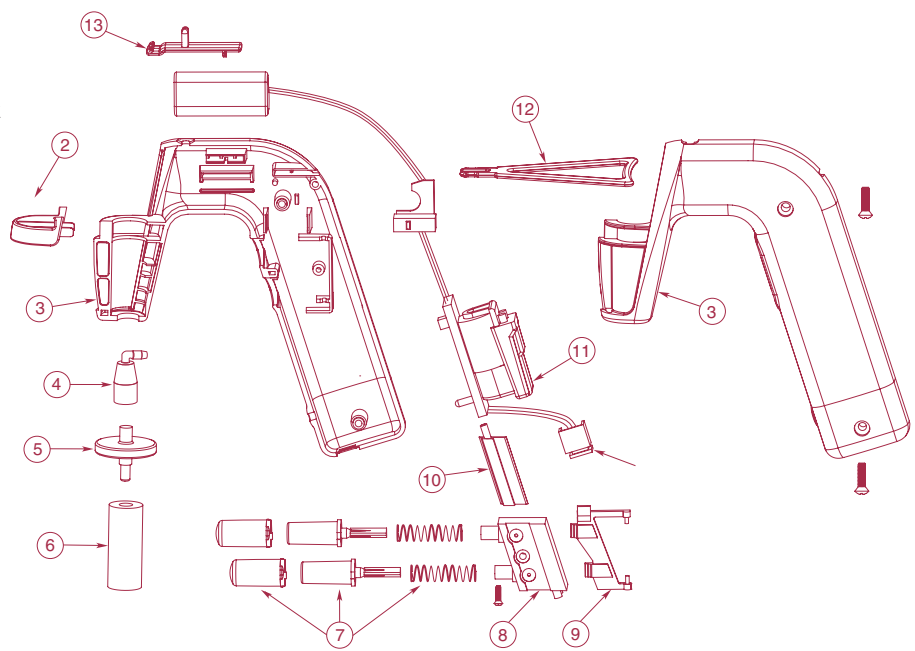

Portable Pipet-Aid® XL

New Ergonomic Design Reduces Fatigue When Pipetting Under a Hood

- Longer lightweight handle lowers your arm position to reduce head, neck, and upper arm strain
- New quiet, more efficient pump reduces noise and extends operation period between charges
- Can be charged while in use to eliminate downtime
- Three-speed settings provide more precise control for both aspirate and dispense modes

Pipetting under a hood doesn't need to be a pain in the neck. The new Drummond Portable Pipet-Aid XL has a longer handle to reduce the amount of arm lift required to perform the same operation as with a conventional pipettor. The ergonomic design includes an adjustable sliding hand rest and a removable stand which enables the unit to be set down without contaminating the pipet. The Portable Pipet-Aid XL also features a new quieter, more powerful pump, and a new EZ Grip nosepiece. The unit is supplied complete with power supply/charger, 4 extra filters, a holster-type wall bracket, and a removable stand.

Specifications

Size	10"
Weight	8 oz.
Capacity	Accepts 1 to 100 mL pipets
Battery	Ni-MH (3.6V/700 mAh)

Cat. No.	Description
4-000-105	Portable Pipet-Aid XL, 110V
4-000-205	Portable Pipet-Aid XL, 240V, CE, Euro
4-000-205-A	Portable Pipet-Aid XL, 240V, Australia
4-000-205-E	Portable Pipet-Aid XL, 230V, CE, UK

Replacement Parts

Cat. No.	Description
4-000-067	(1) XL Handle Shell
4-000-079	(2) EZ Grip Nosepiece
4-000-002	(3) Rubber Insert (2/pk)
4-000-051/051-S	(4) Self-locking TC Filter 5/pk (051-S - Sterile)
4-000-052/052-S	(5) Self-locking TC Filter 50/pk (052-S - Sterile)
4-000-057	(5) TC Rubber Gaskets (Pair)
4-000-063	(6) Handle Connector XL
4-000-064	(7) Nosepiece Release XL
4-000-072	(8) Switch Operator XP/XL
4-000-073	(9) Valve Body XP/XL (complete with buttons and springs)
	(10) Valve Body Slide (Yellow) Included with Valve Body
4-000-070	(11) Button Assembly XP/XL includes springs (12)
4-000-061	(13) XL Pump, board, wire harness, Pump/Valve body connecting tubing included with pump
4-000-036	(15) Battery Pack (XL only)
4-000-062	(16) XL Hand Rest
4-000-068	(17) XL Stand
4-000-065	Not Shown XL Power Supply/Charger 110V, 6 VDC/200 mA
4-000-066	XL Power Supply 240V, CE, Euro
4-000-066-A	XL Power Supply 240V, Australia
4-000-066-E	XL Power Supply 230V, CE, UK
4-000-087	Not Shown TC Nosepiece Kit with 4 filters
4-000-089	Not Shown Pipet-Aid Holster-Type Wall Bracket

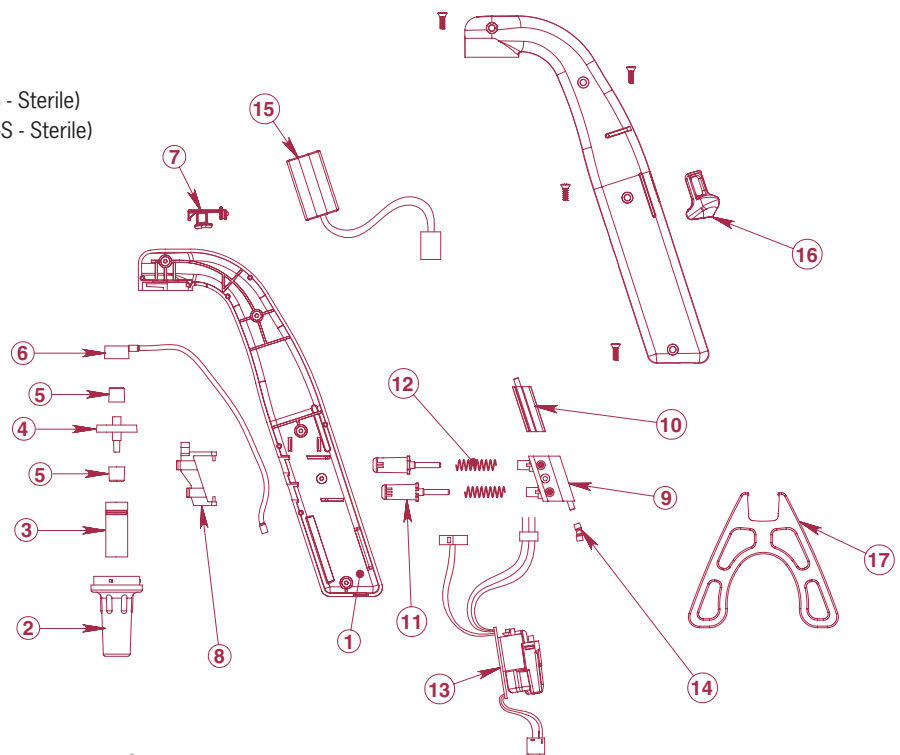
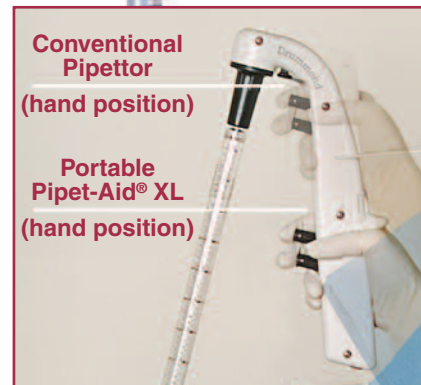

Portable Pipet-Aid® XP

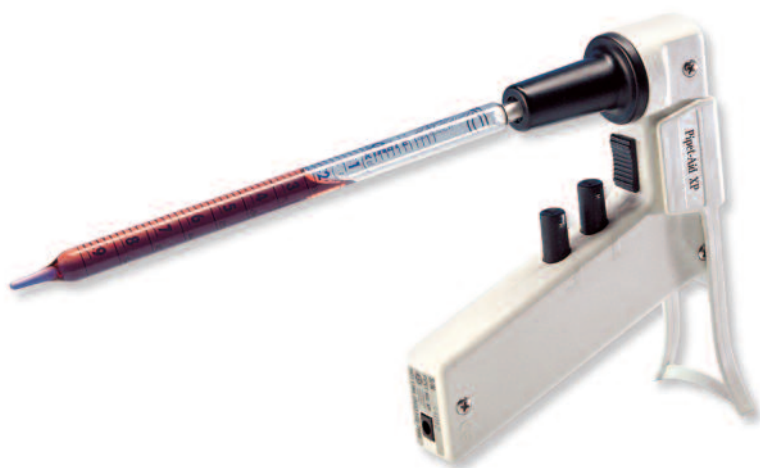

- The lightweight, compact Portable Pipet-Aid®
- Three-speed settings provide more precise control for both aspirate and dispense modes
- Easy access battery replacement
- EZ Grip nosepiece with double membrane filter
- Removable stand
- Holster-type wall bracket included

Specifically designed to minimize operator fatigue, the Portable Pipet-Aid XP is smaller and lightweight. It accepts most pipets from 1 to 100 mL.

Each aspiration and dispense button has three speeds, (F) Fast, (M) Medium, (S) Slow. The medium speed is suitable for most routine techniques. Fast speed can deliver up to 50 mL in 5 seconds and can be used for rapid filling of large pipets or breaking up cell clumps. Slow speed is ideal when using small pipets or when more precise delivery is required. A gravity drain model is available which substitutes a gravity drain (G) function for the fast (F) mode on the dispense button.

The XP is powered by a 9 volt (Ni-MH) rechargeable battery.

A Tissue Culture Nosepiece, which features a unique filter element, will cease to allow air to pass in either direction if it becomes wet, alerting the user to possible contamination of the rubber insert.

Specifications

Size	5.5"
Weight	7.5 oz.
Capacity	Accepts 1 to 100 mL pipets
Battery	9 Volt Ni-MH

Cat. No.	Description
4-000-101	Portable Pipet-Aid XP supplied complete with 110V recharger plus four replacement filters
4-000-201	Same as above but 230V, CE, Euro
4-000-201-E	Same as above but 220V, CE, UK
4-000-102	Portable Pipet-Aid XP with Gravity Drain, 110V
4-000-202	Portable Pipet-Aid XP with Gravity Drain, 230V, CE, Euro
4-000-202-E	Portable Pipet-Aid XP with Gravity Drain, 220V, CE, UK

U.S. Patent Numbers: 5,214,968, 5,616,871, 5,294,405

Replacement Parts

Cat. No.	Description
4-000-002	(2) Rubber Insert (2/pk)
4-000-030	Pipet-Aid Charger 110V, (8.7 V/8 mA)
4-000-031	Pipet-Aid Charger 230V, Euro, (8.7 V/8 mA)
4-000-033	Pipet-Aid Charger 220V, UK, (8.7 V/8 mA)
4-000-035	(5) Ni-MH Rechargeable Battery
4-000-040	(6) Portable Motor and Pump
4-000-051/051-S	(3) Self-locking TC Filter 5/pk (051-S - Sterile)
4-000-052/052-S	Self-locking TC Filter 50/pk (052-S - Sterile)
4-000-057	(4) TC Rubber Gaskets (pair)
4-000-070	(14) Button Assembly XP/XL includes springs (pair)
4-000-072	(7) XP Switch Operator
4-000-073	(8) Valve Body XP/XL (complete with buttons, springs, and gaskets)
4-000-074	(9) XP Nosepiece Release
4-000-075	(10) XP Handle Connector
4-000-076	(11) XP Wire Harness, Switch and Terminals
4-000-077	(12) XP Handle Shell includes 2 Handle Halves and 1 Battery Door
4-000-078	(13) XP Battery Door
4-000-079	(1) EZ Grip Nosepiece
4-000-087	Tissue Culture Nosepiece Kit for XP, XL, and Hood Mate (includes 1, 2, 3, 4)
4-000-089	Pipet-Aid Holster-Type Wall Bracket

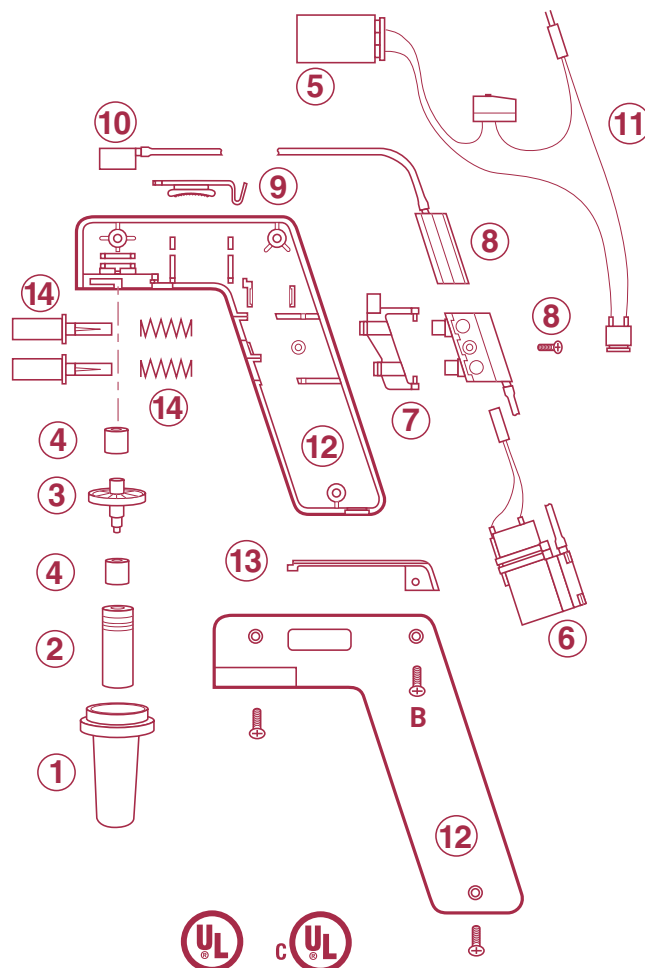

Original Portable Pipet-Aid®

- Pipets over 2000 times without recharging
- Flow rate better than 25 mL at 5 seconds with 100 mL pipet
- Cordless convenience
- Tissue Culture Nosepiece provides quick disconnect and easier assembly
- Holster-type wall bracket included

Used by millions of technicians all over the world, the Portable Pipet-Aid has earned a well-deserved reputation for reliability and durability in the laboratory. The filtered, failsafe nosepiece provides positive protection for the electronic components and prevents cross-contamination due to over-pipetting.

Cat. No.	Description
4-000-100	Supplied complete with 110V recharger (UL/CSA approved) plus four replacement filters
4-000-200	Same as above but 230V, CE, Euro
U.S. Patent Numbers: 5,214,968, 4,624,147	

Replacement Parts

Cat. No.	Description
4-000-002	(1) Rubber Insert (2/pk)
4-000-012-W	(2) Valve Body Only
4-000-013	(3) Handle Connector
4-000-017-P	(4) Handle Shell, Portable
4-000-021	(5) Button Assembly with Spring (pair)
4-000-030	Pipet-Aid Charger 110V, (8.7 V/8 mA)
4-000-031	Pipet-Aid Charger 230V, CE, Euro (8.7 V/8 mA)
4-000-033	Pipet-Aid Charger 220V, CE, UK (8.7 V/8 mA)
4-000-035	(6) Ni-MH Rechargeable Battery
4-000-037	(7) Portable Micro-Switch
4-000-040	(8) Portable Motor and Pump
4-000-046	(9) Wire Harness Switch and Terminal Port
4-000-050	(10) EZ Grip TC Nosepiece Complete Kit (see page 3)
4-000-051/051-S	(11) Self-locking TC Filter 5/pk (051-S - Sterile)
4-000-052/052-S	Self-locking TC Filter 50/pk (052-S - Sterile)
4-000-053-A	(12) EZ Grip TC Nosepiece Outer Shell Only
4-000-057	(13) TC Rubber Gaskets (pair)
4-000-089	Pipet-Aid Holster-Type Wall Bracket



Pipet-Aid Holster-Type Wall Bracket 4-000-089

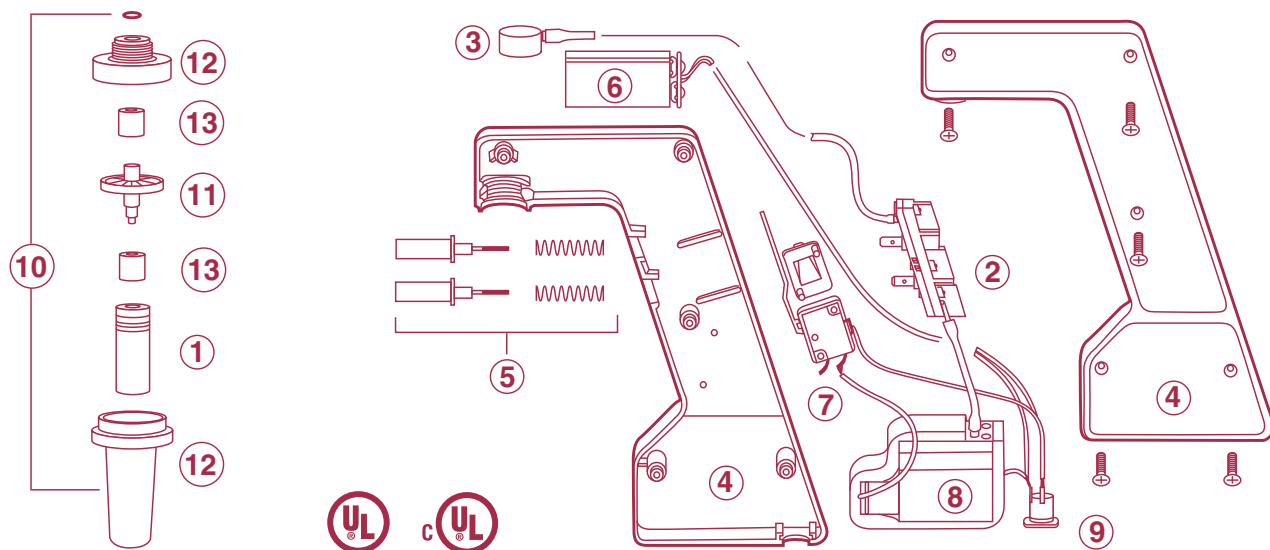

Pipet-Aid® Hood Mate®

- Longer 6' coiled hose
- Extremely lightweight (4.3 oz.) handle provides nine fill and empty speed settings and proportional fingertip control
- Never needs recharging—handle holder incorporates “auto-off” feature
- Energy saving “auto-off” feature automatically shuts unit off after 3 minutes of nonuse
- Compact, convenient, and won't walk away. Dedicated pump housing attaches to hood wall which saves space and prevents spills
- Coiled vacuum/pressure line entering handle from the top prevents accidental knocking over of bench items

The Drummond Pipet-Aid Hood Mate is specifically designed for convenient, comfortable pipetting under a hood. The Pipet-Aid Hood Mate can deliver precise volumes with exact control. This new unit is lightweight, never requires recharging, and won't walk away from your workstation. All materials of construction are UV resistant.



Cat. No.

Description

4-000-300	Pipet-Aid Hood Mate, 110V
4-000-302	Pipet-Aid Hood Mate, 220V, CE, Euro
4-000-303	Pipet-Aid Hood Mate, 220V, CE, UK

Replacement Parts

Cat. No.

Description

4-000-002	Rubber Insert (2/pk)
4-000-051/051-S	Self-locking TC Filter 5/pk (051-S - Sterile)
4-000-052/052-S	Self-locking TC Filter 50/pk (052-S - Sterile)
4-000-057	TC Rubber Gaskets (pair)
4-000-079	EZ Grip Nosepiece (Black)
4-000-080	Power Supply, 110V
4-000-081	Power Supply, 220V, CE, Euro
4-000-081-E	Power Supply, 220V, CE, UK
4-000-082	Backing Plate w/Tape
4-000-083	Replacement Tape
4-000-084	Valve Body Assembly with Buttons
4-000-085	Coiled Hose (6')
4-000-086	Hose Support
4-000-087	TC Nosepiece Kit with 4 filters
4-000-088	Handle Hook

U.S. Patent Numbers:
5,214,968, 5,294,405

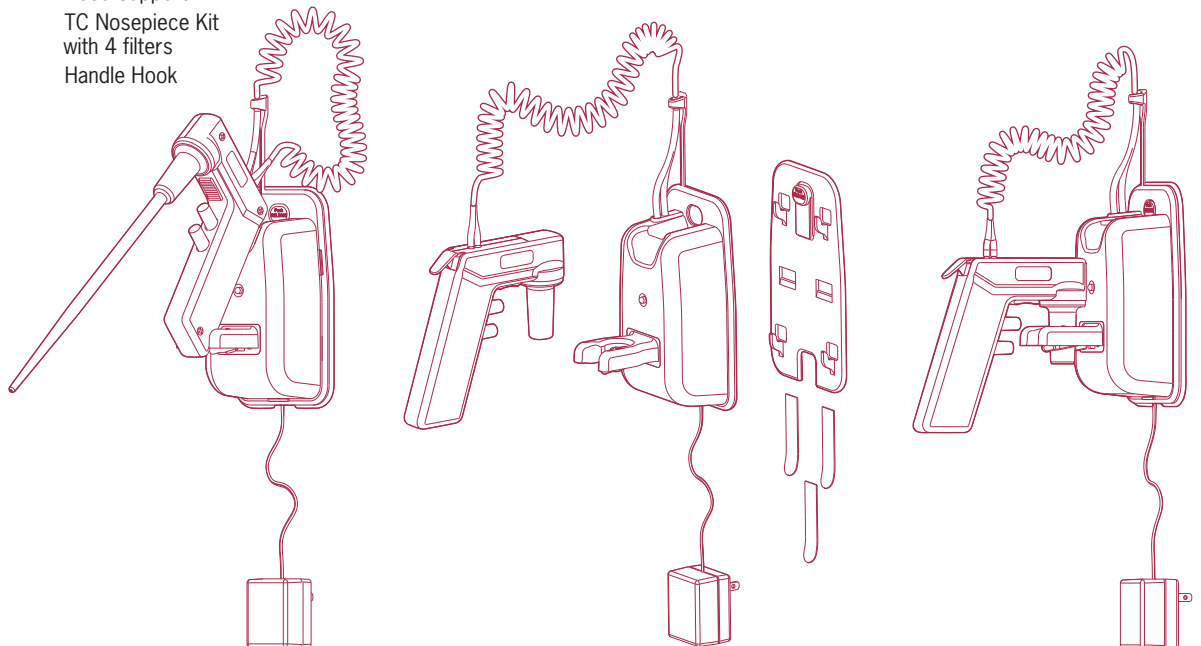

Original Pipet-Aid®

- Available with or without EZ Grip TC filter nosepiece
- Available with dual pump filtration unit for use with biohazardous materials
- Can be used with glass or plastic pipets
- Autoclavable components



The Drummond Pipet-Aid set the standard for a convenient alternative to mouth pipetting in the laboratory. A patented, easy-to-use volume control mechanism permits precise fluid intake and delivery.

A check valve protects against accidental fluid intake into the handle and optional Tissue Culture Nosepiece will prevent cross-contamination due to over-pipetting. A special filtration unit for use with biohazardous materials is also available.

Cat. No.	Description
4-000-110	Pipet-Aid, Plain, 110V
4-000-111	Pipet-Aid, with Dual Pump Filtration Unit, 110V
4-000-110-TC	Pipet-Aid complete with TC Nosepiece and four extra Filters, 110V
4-000-111-TC	Same as above but with Dual Pump Filtration Unit, 110V
4-000-220	Pipet-Aid, Plain, 220V, CE, Euro
4-000-221	Pipet-Aid, with Dual Pump Filtration Unit, 220V, CE, Euro
4-000-220-TC	Pipet-Aid complete with TC Nosepiece and four extra Filters, 220V, CE, Euro
4-000-221-TC	Same as above but with Dual Pump Filtration Unit, 220V, CE, Euro

U.S. Patent Number: 4,624,147

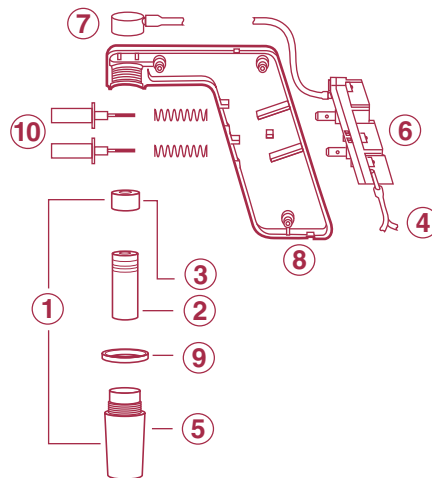

Pipet-Aid Replacement Parts

Cat. No.	Description
4-000-001	(1) Standard Nosepiece, Complete
4-000-002	(2) Rubber Insert (2/pk)
4-000-003	(3) Check Valve Assembly
4-000-004	(4) Hose (5')
4-000-005	Filter Adapter Kit
4-000-006	Complete Handle Assembly
4-000-007	Complete Pump 110V
4-000-008	Internal Parts Kit with Hose
4-000-009	(5) Pipet Holder Outer Shell only
4-000-010	Diaphragm Kit for Pump
4-000-011	Hose Connectors (pair)
4-000-012-W	(6) Valve Body only
4-000-013	(7) Handle Connector
4-000-014	Complete Pump 220V
4-000-015	Vacuum Valve Housing for Pump
4-000-016	Pressure Valve Housing for Pump
4-000-017	(8) Handle Shell only
4-000-018	(9) Nose Ring
4-000-019	(10) Button Assembly with springs (pair)
4-000-050	EZ Grip TC Nosepiece Complete Kit (see page 3)
4-000-051/051-S	Self-locking TC Filter 5/pk (051-S - Sterile)
4-000-052/052-S	Self-locking TC Filter 50/pk (052-S - Sterile)
4-000-053-A	EZ Grip TC Nosepiece Outer Shell only
4-000-060	Dual Pump Filters (pair)
4-000-089	Pipet-Aid Holster-Type Wall Bracket

Pipet-Aid® Dual Pump Filtration Unit

For use in a biohazardous environment, a filtration unit can be installed on the Pipet-Aid pump which will filter both vacuum and pressure lines. Incorporating dual filters, the Pipet-Aid Biohazard Filter Kit has a retention efficiency of 99.9999+% for 0.1 micron particles and droplets.

Normally factory installed, the Filter Adapter Kit can be attached to existing unfiltered Pipet-Aid pumps.

Cat. No.	Description
4-000-005	Filter Adapter Kit
4-000-060	Dual Pump Filters (pair)

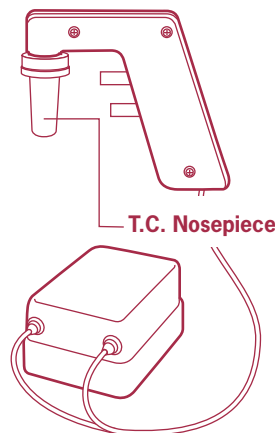

4-000-110-TC
4-000-220-TC
Single Pump Unit

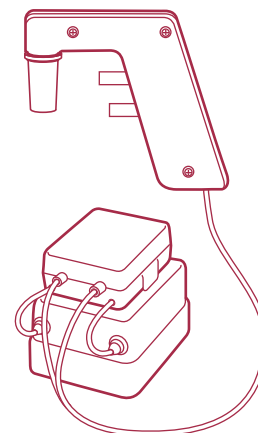

4-000-111
4-000-221
Dual Pump Filtration Unit
(Replacement Filter No. 4-000-060)

Nanoject II™ Auto-Nanoliter Injector

- Automated microprocessor controlled Microinjection Pipet delivering precise nanoliter volumes accurately
- Remote control and nonrotating plunger eliminates vibration allowing precise injection minimizing possible cell rupture

Nanoject II offers these exceptional features

- Selectable Injection Volumes: from 2.3 nanoliters to 69.0 nanoliters in 16 increments
- Selectable Operating Speeds:

Fill Speed	Fast	46 nL per second
	Slow	23 nL per second
Injection Speed	Fast	46 nL per second
	Slow	23 nL per second
Empty Speed	Fast	230 nL per second
	Slow	92 nL per second
- Supplied with sufficient borosilicate glass capillaries for preparing 400 injection tips, standard softening point 780°C
- Can be mounted on most micromanipulators
 - Note: Universal Adapter 3-000-024-A supplied with unit**
- Separate Foot Switch available to allow hands-free operation (see page 12)

The Drummond Nanoject II Auto-Nanoliter Injector is specifically designed to perform ultra-delicate nanoliter injection procedures into oocytes, embryos, and tissues.

Each Nanoject II Auto-Nanoliter Injector comes complete with 200 borosilicate capillaries that can be pulled to the required tolerance together with a back filling needle and maintenance kit.

Cat. No.	Description
3-000-204	Nanoject II Variable Volume (2.3 to 69 nL) Automatic Injector with Glass Capillaries (110V)
3-000-205A	Nanoject II, 220V, CE, Euro
3-000-206A	Nanoject II, 220V, CE, UK

Note: Universal Adapter supplied with all the above units

Nanoject II Replacement Parts

Cat. No.	Description
3-000-002-KN	O-Ring kit for Models 204, 205A, and 206A includes: 1 collet, 1 small O-Ring, 1 spacer, 1 compression O-Ring, and 1 Allen wrench
3-000-027	30 gauge, 2" Backfilling Needle
3-000-000-203-X	Pointed Plunger Wire

Nanoject II Replacement Glass Capillaries

Cat. No.	O.D. (mm)	Length	I.D. (mm)	Pack
3-000-203-G/X	1.14	3.5"	0.53	100
3-000-203-G/XL	1.14	7"	0.53	100



Recording Nanoject II™

Enables High Precision Electrophysiological Guidance of Nanoliter Injections into the Brain

- Facilitates connection to an extracellular amplifier to allow recording of neural activity
- Supplements stereotaxic coordinates in guiding the placement of small injections
- Provides direct displacement of neuronal tracer or excitotoxin from the pipet
- Can be used on stereotaxic equipment utilizing 7.9 mm clamps

Note: Universal Adapter 3-000-024-A supplied with unit

The Drummond Recording Nanoject II was specifically developed to improve micro-volume injection techniques used to study connectivity and function of specific brain nuclei. Designed to be operated in conjunction with an extracellular amplifier, the integrated system can be used to reliably place small volumes into targeted areas. The Recording Nanoject II is engineered to easily mount on popular stereotaxic instruments.

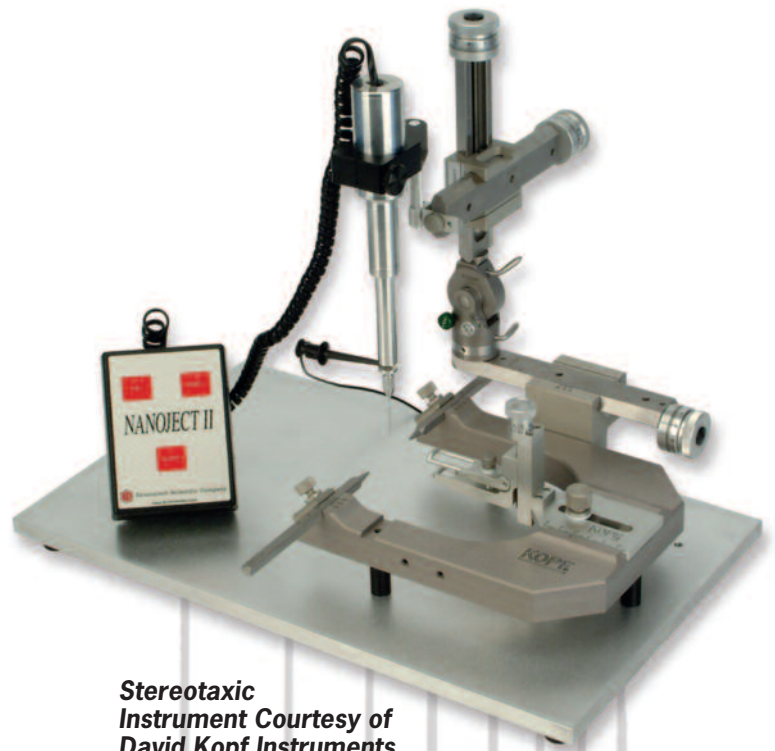

Stereotaxic Instrument Courtesy of David Kopf Instruments

Recording Nanoject II™

Cat. No.	Description
3-000-204-RN	Recording Nanoject II, 110V
3-000-205-RN	Recording Nanoject II, 220V, CE, Euro
3-000-206-RN	Recording Nanoject II, 220V, CE, UK

Note: Universal Adapter supplied with all the above units

Replacement Parts and Accessories

Cat. No.	Description
3-000-002-KN	O-Ring kit for Models 204-RN, 205-RN, and 206-RN includes: 1 aluminum collet, 1 small O-Ring, 1 spacer, 1 compression O-Ring, and 1 Allen wrench
3-000-024-A	Universal Adapter (included)
3-000-027	30 gauge, 2" Backfilling Needle

Replacement Glass Capillaries

Cat. No.	O.D. (mm)	Length	I.D. (mm)	Pack
3-000-203-G/X	1.14	3.5"	0.53	100
3-000-203-G/XL	1.14	7"	0.53	100

Nanoject II™ Accessories

Nanoject II Accessories

Cat. No.	Description
3-000-024-A	Universal Adapter*
3-000-024-L	MM33 Micromanipulator (Left) with 1/2" clamp
3-000-024-R	MM33 Micromanipulator (Right) with 1/2" clamp
3-000-025	Tilting Base
3-000-025-MB	Magnetic Base
3-000-025-SB	Support Base
3-000-026	Foot Switch

*Can be used on stereotaxic equipment using 7.9 mm clamps



Universal Adapter
3-000-024-A



Note:
Support base and
magnetic base
are supplied with
1/2" stainless
steel rods

3-000-025-SB



3-000-025-MB

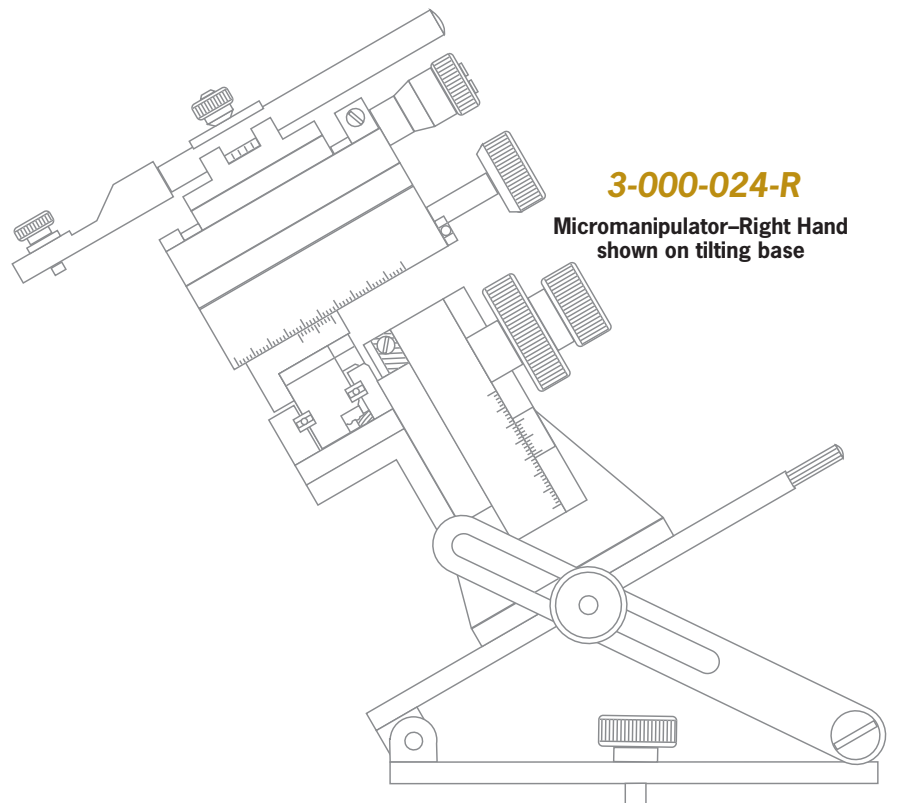

3-000-024-R

Micromanipulator-Right Hand
shown on tilting base

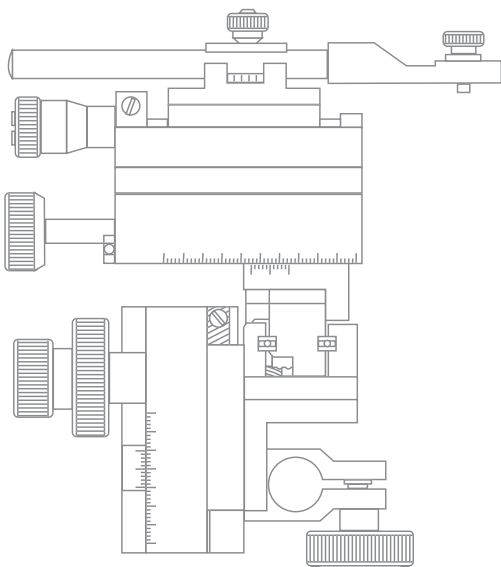

3-000-024-L

Micromanipulator-Left Hand

3-000-025

Tilting Base

Manual Oocyte Microinjection Pipet

- Nonrotating plunger eliminates tip wobble, allows more precise deposition
- Inject volumes of 30 nanoliters or more with reproducible accuracy, drives oil interface with minimal or no overshoot
- Utilizes pulled capillary tips, supplied with 100 8" glass capillaries sufficient for preparing 200 tips. User must pull their own tips.

Cat. No.	Description
3-000-510-X	Oocyte Pipet with 100 8" Glass Capillaries

Oocyte Microinjection Pipet Replacement Parts

Cat. No.	Description	Pack
3-000-210-G	Replacement Glass 3.5"	100
3-000-210-G8	Replacement Glass 8"	100
3-000-027	30 gauge, 2" Backfilling Needle	1
3-000-002-K10	O-Ring Kit, Model 510-X	1
3-000-000-210-X	Wire Plunger	1



Sequencing Pipet

- The first variable volume Microdispenser designed for DNA sequencing operations
- Two tapered polycarbonate tips available (.34 mm O.D. and .19 mm O.D.) to provide precise nanoliter sample delivery into narrow (.35 mm and 0.2 mm) gel slots
- Noncontact plunger and replaceable autoclavable tips
- Volume range: .25 μ L to 3 μ L

The Drummond Gel Sequencing Pipet is engineered to overcome sample delivery problems typical of DNA sequencing operations.

Cat. No.	Description	Pack
3-000-203	Gel Sequencing Pipet Supplied with six .34 mm Bores	1
3-000-203-G	Replacement Bores .34 mm	10
3-000-203-G/.2	Replacement Bores .19 mm	10
3-000-002-K3	O-Ring Kit, Model 203	1



Positive Displacement Digital Microdispensers

- Direct digital set and readout for fractional microliters
- Positive lock prevents accidental volume changes
- Repeat Kit available for Model 590 and 390
- Overall volumetric accuracy of $\pm 1\%$ (at full volume)
- Borosilicate glass bores with stainless steel plungers, (PTFE tips on all plungers 25 μL or larger)
- polypropylene bore on Model 590

Cat. No.	Total Capacity (μL)	Recommended Range (μL)	Delivery Increments (μL)
3-000-510	10	2.0 to 10	0.01
3-000-525	25	5 to 25	0.1
3-000-550	50	10 to 50	0.1
3-000-575	100	20 to 100	0.1
3-000-590	1000	100 to 1000	1.0

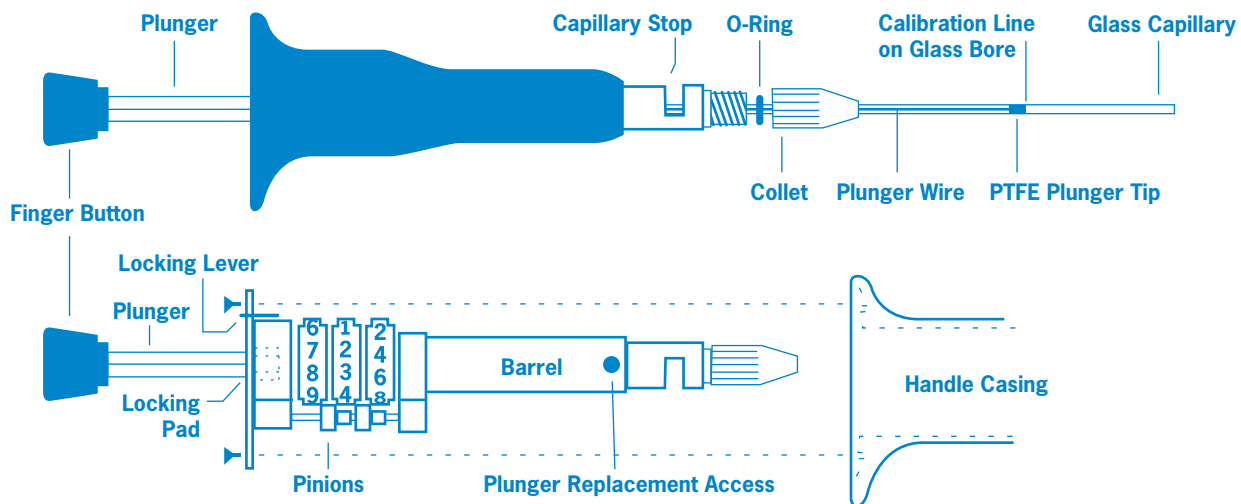

Replacement Parts Kits for Digital Microdispensers

Cat. No.	Microdispenser Volume Range (μL)	Digital Microdispenser Cat. No.	Kit Contents
3-000-010-K	2-10	3-000-510	2 plungers, 2 O-rings, 1 collet, 1 coil spring, 1 spring guide
3-000-025-K	5-25	3-000-525	1 plunger, 2 O-rings, 1 collet, 1 coil spring, 3 PTFE tips, 1 spring guide
3-000-050-K	10-50	3-000-550	1 plunger, 2 O-rings, 1 collet, 1 coil spring, 3 PTFE tips, 1 spring guide
3-000-075-K	20-100	3-000-575	1 plunger, 2 O-rings, 1 collet, 1 coil spring, 3 PTFE tips, 1 spring guide
3-000-010-590	100-1000	3-000-590	3 Plunger Tips (polyethylene)

Replacement Bores: see page 16

Stainless Steel Manifolds for Microtest Plates

Feed, Rinse, or Aspirate Multiple Plate Positions Quickly and Easily

- Autoclavable stainless steel and PTFE construction
- Use for both sample delivery and aspiration operations
- Supplied complete with cleaning wire for easy cleaning
- Positive Luer lock connection
- Custom manifolds available

Drummond Dispensing Manifolds

Cat. No.	Description	Center to Center (mm)	Pin Length (mm)*
3-000-090	Straight, 4 place for 96 well plate	9	11
3-000-093	Straight, 8 place for 96 well plate	9	11
3-000-094	Bent, 8 place for 96 well plate	9	11
3-000-095	End Caps (all)	-	-
3-000-096	Straight, 12 place for 96 well plate	9	11
3-000-097	Straight, 4 place for 24 well plate	20	17.5
3-000-098	Bent, 4 place for 24 well plate	20	17.5
3-000-099	Bent, 12 place for 96 well plate	9	11
3-000-101	Straight, 24 place for 384 well plate	4.5	11
3-000-102	Straight, 16 place for 384 well plate	4.5	11
3-000-103	Bent, 24 place for 384 well plate	4.5	11
3-000-104	Bent, 16 place for 384 well plate	4.5	11

*Pin O.D. .031", I.D. .018"

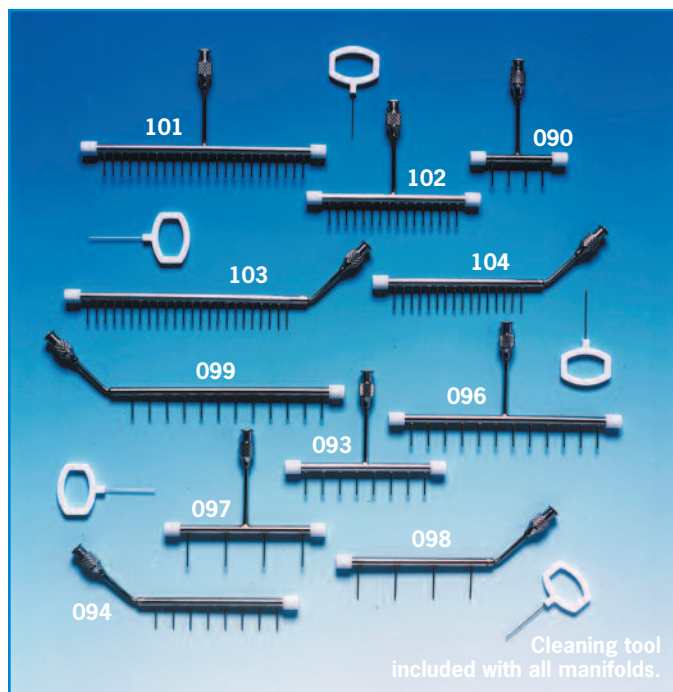

Repeat Kit with Valve

- Adapts to Models 390 and 590 for continuous pipetting operations
- Each kit contains: Microvalve, Three-way Valve, Stainless Steel Sinkers, 30" Tygon® Tubing 3/32" I.D., Luer Pipet Tips, and 7 Polypropylene Tubing Connectors

Cat. No.	Description
3-000-091	Repeat Kit (includes valve)



Dialamatic Microdispenser

- Adjustable, direct reading plunger sets volume
- Delivery scale engraved on plunger shaft
- Fractional deliveries possible with premarked indexes
- Volumetric accuracy of $\pm 1\%$ (at full volume)
- Borosilicate glass bores with stainless steel plungers, (PTFE tips on all plungers 25 μL or larger)

Cat. No.	Total Capacity (μL)	Recommended Range (μL)	Delivery Increments (μL)
3-000-210	10	2.0 to 10	1
3-000-225	25	5 to 25	1
3-000-250	50	10 to 50	2
3-000-275	100	20 to 100	10

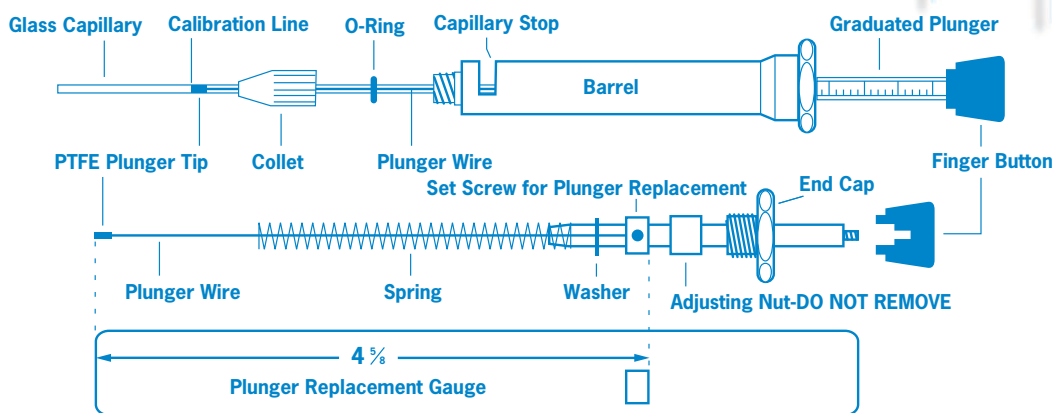

Replacement Parts Kits for Dialamatic Microdispensers

Cat. No.	Microdispenser Volume Range (μL)	Dialamatic Microdispenser Cat. No.	Kit Contents
3-000-010-K	2-10	3-000-210	2 plungers, 2 O-rings, 1 collet, 1 coil spring, 1 spring guide
3-000-025-K	5-25	3-000-225	1 plunger, 2 O-rings, 1 collet, 1 coil spring, 3 PTFE tips, 1 spring guide
3-000-050-K	10-50	3-000-250	1 plunger, 2 O-rings, 1 collet, 1 coil spring, 3 PTFE tips, 1 spring guide
3-000-075-K	20-100	3-000-275	1 plunger, 2 O-rings, 1 collet, 1 coil spring, 3 PTFE tips, 1 spring guide

Microdispenser Accessories and Replacement Parts

Bulk Replacement Parts

Cat. No.	Description	Pack
PTFE® Tips		
3-000-0101	PTFE Tips, 25 μL	50
3-000-0102	PTFE Tips, 50 μL	50
3-000-0103	PTFE Tips, 100 μL	50

NOTES: (1) PTFE tips are not required on 20 μL and smaller units.
 (2) Plunger wire and O-Ring are not required on 1000 μL size.

Replacement Bores for All Microdispensers

Size (μL)	Glass Color Code	Bores	Pack
1 to 5	White	3-000-105-G	100
10	Orange	3-000-210-G	100
20	Black	3-000-320-G	100
25	Double White	3-000-225-G	100
50	Green	3-000-250-G	100
100	Blue	3-000-275-G	100
100/200	Blue	3-000-275-G	100
250	Black	3-000-388-G	100
1000	Plastic Tip	3-000-590-G	100

Fixed Volume Microdispensers

- Custom spacers available permitting fractional deliveries on all units
- Overall volumetric accuracy of $\pm 1\%$ (at full volume)
- Repeat Kit available for 1000 μL unit
- Precision molded plastic bores on Model 390
- Model 105 will deliver 1 to 5 μL
- Borosilicate glass bores with stainless steel plungers, (PTFE tips on all plungers 25 μL or larger)



Cat. No.	Size (μL)
3-000-105	5
3-000-310	10
3-000-320	20
3-000-325	25
3-000-350	50
3-000-375	100
3-000-385	100/200
3-000-388	250
3-000-390	1000

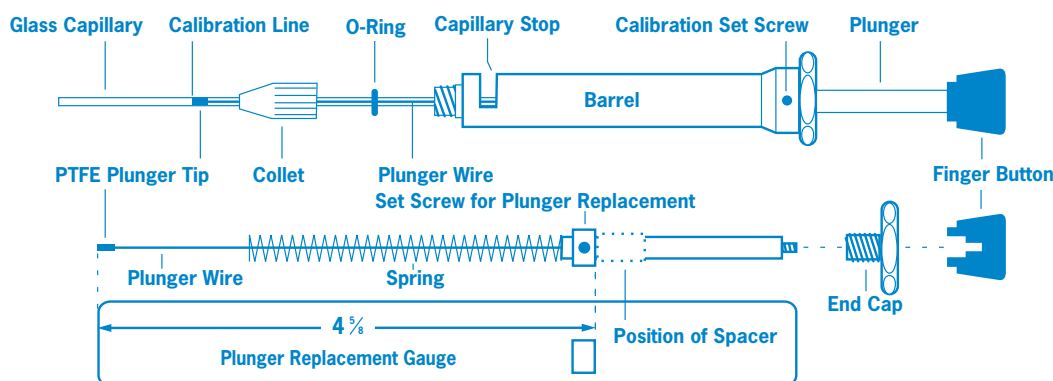

Replacement Parts Kits for Fixed Volume Microdispensers

Cat. No.	Microdispenser Volume Range (μL)	Fixed Volume Microdispenser Cat. No.	Kit Contents
3-000-005-K	5	3-000-105	2 plungers, 2 O-rings, 1 collet, 1 coil spring, 1 spring guide
3-000-310-K	10	3-000-310	2 plungers, 2 O-rings, 1 collet, 1 coil spring, 1 spring guide
3-000-320-K	20	3-000-320	2 plungers, 2 O-rings, 1 collet, 1 coil spring, 1 spring guide
3-000-325-K	25	3-000-325	1 plunger, 2 O-rings, 1 collet, 1 coil spring, 3 PTFE tips, 1 spring guide
3-000-350-K	50	3-000-350	1 plunger, 2 O-rings, 1 collet, 1 coil spring, 3 PTFE tips, 1 spring guide
3-000-375-K	100	3-000-375	1 plunger, 2 O-rings, 1 collet, 1 coil spring, 3 PTFE tips, 1 spring guide
3-000-385-K	100/200	3-000-385	1 plunger, 2 O-rings, 1 collet, 1 coil spring, 3 PTFE tips, 1 spring guide
3-000-388-K	250	3-000-388	1 plunger, 2 O-rings, 1 collet, 1 coil spring, 3 PTFE tips, 1 spring guide
3-000-010-590	1000	3-000-390	3 plunger tips (polyethylene)

Replacement Bores: See page 16

Special Sample Collection Tubes

- Single use, disposable glass capillary pipets with hydrophobic plug preset to precise volume delivery
- Plug controls volume and serves as a piston which dispenses sample when pressed downward by reusable plunger
- Once used Aqua-Cap cannot be used again, eliminates any potential cross-contamination
- Available in the sizes below in packages of 100
- 5 Plungers/Vial

Cat. No.	Description	Color Code	Qty.
7-000-0500	Aqua-Cap, 50 µL	Green	100 pcs/5 plungers
7-000-0650-LHC	Aqua-Cap, 65 µL	Blue	50 pcs/50 plungers Lithium heparin clad
7-000-1000	Aqua-Cap, 100 µL	Blue	100 pcs/5 plungers



OEM Glass and Plastic Capillary Tubing

Precision Micro Liquid Transfer Components Produced to Specifications

Drummond Scientific specializes in the production of glass, plastic, and plastic coated capillary tubing for a wide range of scientific and clinical OEM applications. Our unique manufacturing capability and technical expertise can also be applied to your specialized liquid sample transfer product or kit requirement. For more information please call.

Collection Tubes

0.4 mm I.D. x 75 mm Capillary Tube

Cat. No.	Description	Package Size
1-000-800/12	Capillary	1200/Case

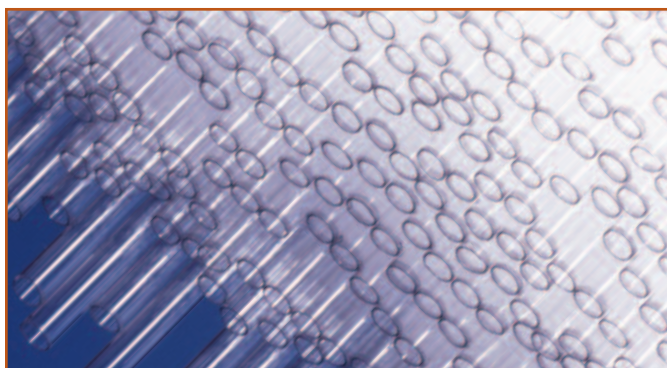

Calibrated Micropipets

- Fire polished
- Accuracy of $\pm 0.5\%$
- Color coded Micropipets with sizes imprinted
- Anticoagulant treatment for clinical applications (special limited sizes)

Superior quality, Drummond precision Calibrated Micropipets are available in sizes ranging from 1 to 200 microliters. Ideal for a variety of liquid transfer work, 250 color coded micropipets, plus one 15" aspirator tube are supplied in a conveniently designed, easy-to-store cylinder. For blood transfer work, a heparinized 44.7 microliter pipet is also available.

Cat. No.	Size (μL)	Color Code	Pack
2-000-001	1 to 5	White	250
2-000-005	5	White	250
2-000-010	10	Orange	250
2-000-020	20	Black	250
2-000-025	25	Double White	250
2-000-030	30	Double Black	250
2-000-040	40	Yellow	250
2-000-044	44.7	Purple/Blue	250
2-000-044-H	44.7 Heparin	Purple/Green	250
2-000-050	50	Green	250
2-000-075	75	Purple	250
2-000-100	100	Blue	250
2-000-200	200	Red	250
2-000-201	100/200	Red	250
2-000-000	15" Aspirator Tube Assembly		1



Captrol III®

- Perform simple aspiration and dispensing operations from 1 to 100 μL with rotating volume control
- Use with calibrated micropipets

Cat. No.	Description	Pack
3-000-752	Captrol III	1
3-000-002-K752	O-Ring Kit Includes 2 O-Rings, 1 Small and 1 Large Hole Silicone Tip	
1-000-9003	Silicone Tip	3



Wiretrol® I

- Economical positive displacement micropipet with fingertip control
- Ideal for a wide variety of applications
- 100 glass micropipets and 1 reusable plunger

The Drummond Wiretrol provides the accuracy and high speed action generally found in expensive microdispensers at a fraction of the cost. A unique combination of a disposable precision bore calibrated micropipet and a stainless steel plunger with fingertip handle, the Wiretrol will accept both high and low viscosity liquids including corrosives.



Wiretrol I Plungers

Cat. No.	Sizes (µL)	Color Code	Pack
5-000-1001	1 to 5*	White	100
5-000-1003	3*	Yellow	100
5-000-1005	5*	White	100
5-000-1010	10*	Orange	100
5-000-1020	20*	Black	100
5-000-1025	25*	Double White	100
5-000-1050	50**	Green	100
5-000-1100	100**	Blue	100

Cat. No.	Description	Qty.
5-000-1000-1	Plunger, Wiretrol I, 1, 3, & 5 µL	1 ea.
5-000-1000-2	Plunger, Wiretrol I, 10 µL	1 ea.
5-000-1000-3	Plunger, Wiretrol I, 20 µL	1 ea.
5-000-1000-4	Plunger, Wiretrol I, 25 µL	1 ea.
5-000-1000-5	Plunger, Wiretrol I, 44.7 & 50 µL	1 ea.
5-000-1000-7	Plunger, Wiretrol I, 100 µL	1 ea.

Wiretrol® II

- Dual graduations for noncontact delivery
- With both standard length and short length plungers

The Wiretrol II provides the accuracy and convenience of the Wiretrol I but with dual graduations and a shorter plunger for noncontact delivery.



Wiretrol II Plungers

Cat. No.	Sizes (µL)	Color Code	Pack
5-000-2005	1 to 5*	White	250
5-000-2010	5 and 10*	White	250
5-000-2020	10 and 20*	Orange	250
5-000-2050	25 and 50**	Double White	250
5-000-2100	50 and 100**	Green	250
5-000-2200	100 and 200**	Blue	250

Cat. No.	Description	Qty.
5-000-2000-L	SS Plunger, 1-5/5 & 10 µL/WRTL II, Long	1 ea.
5-000-2000-S	SS Plunger, 1-5/5 & 10 µL/WRTL II, Short	1 ea.
5-000-2001-L	SS Plunger, 10 & 20 µL/WRTL II, Long	1 ea.
5-000-2001-S	SS Plunger, 10 & 20 µL/WRTL II, Short	1 ea.
5-000-2002-L	SS Plunger, 25 & 50 µL/WRTL II, Long	1 ea.
5-000-2002-S	SS Plunger, 25 & 50 µL/WRTL II, Short	1 ea.
5-000-2003-L	SS Plunger, 50 & 100 µL/WRTL II, Long	1 ea.
5-000-2003-S	SS Plunger, 50 & 100 µL/WRTL II, Short	1 ea.
5-000-2004-L	SS Plunger, 100 & 200 µL/WRTL II, Long	1 ea.
5-000-2004-S	SS Plunger, 100 & 200 µL/WRTL II, Short	1 ea.

*Wire plunger only

**Wire Plunger with PTFE tip

Microcaps[®]

- The original, disposable Drummond Microcap
- The most accurate ($\pm 1\%$)¹
- The most dependable
- The easiest to use micropipet available anywhere!

Drummond Microcaps are a fast, safe, clean, and accurate way to transfer liquids in micro quantities. They are precision-bore glass capillary tubes cut to predetermined lengths so that fill volumes are constant and precise. Microcaps are inexpensive and disposable.

Using a Microcap is simple. Capillary action draws the fluid into the tube and a squeeze of the bulb will dispense it. For spotting applications such as TLC, a unique spotting holder is available which will allow the liquid to be dispensed simply by touching the tube to the spotting surface.

100 Microcaps and one Bulb Dispenser included.

¹Volume 45, No. 8, Analytical Chemistry, Carl F. Emanuel

Special Sizes

Cat. No.	Capacity (μL)	Length (mm)	Relative (in.)	
			O.D.	I.D.
1-000-0001	0.1	16	.0180	.0035
1-000-0002	0.2	32	.0180	.0035
1-000-0005-64	0.5	64	.0210	.0039
1-000-0010-64	1.0	64	.0220	.0056
1-000-0010-55	1.0	55	.0250	.0060
1-000-0020-55	2.0	55	.0260	.0085
1-000-0030-55	3.0	55	.0340	.0104
1-000-0050-55	5.0	55	.0340	.0134
1-000-0200-32	20.0	32	.0470	.0351
1-000-0400-80	40.0	80	.0430	.0314
1-000-1000-100	100.0	100	.0610	.0444

Special Note: Usually any capacity/length combination can be custom ordered. Please call for a quotation.

Bulb Dispensers

Cat. No.	Description	Pack
1-000-9000	Bulb Dispenser	1 ea.
1-000-9003	Silicone Tips	3

PCR Pipets

- Disposable, positive displacement micropipets with stainless steel plungers
- Measure true sample volumes regardless of viscosity, eliminates contamination from residual aerosols
- Decontaminate at temperature of 400°F or higher

Cat. No.	Description	Pack
5-000-1001-X	5 μL PCR Pipet	100 Glass Micropipets/100 Plungers
5-000-1001-X10	10 μL PCR Pipet	100 Glass Micropipets/100 Plungers



Bulb Dispenser with Microcap Inserted

Standard Sizes

Cat. No.	Capacity (μL)	Length (mm)	Relative (in.)	
			O.D.	I.D.
1-000-00025	0.25	32	.0210	.0039
1-000-0005*	0.5	32	.0220	.0056
1-000-0010*	1.0	32	.0260	.0079
1-000-0020*	2.0	32	.0300	.0111
1-000-0030	3.0	32	.0340	.0136
1-000-0033	3.33	36	.0340	.0136
1-000-0040	4.0	32	.0340	.0157
1-000-0050*	5.0	32	.0370	.0176
1-000-0060	6.0	38.4	.0370	.0176
1-000-0066	6.66	72	.0340	.0135
1-000-0070	7.0	44.8	.0370	.0176
1-000-0080	8.0	44	.0380	.0189
1-000-0090	9.0	49.5	.0380	.0189
1-000-0100*	10.0	41	.0315	.0219
1-000-0150	15.0	54	.0340	.0234
1-000-0200	20.0	64	.0355	.0248
1-000-0250	25.0	65	.0382	.0276
1-000-0300	30.0	78	.0382	.0276
1-000-0350	35.0	70	.0430	.0314
1-000-0400	40.0	52	.0555	.0390
1-000-0447	44.7	51.8	.0565	.0413
1-000-0500	50.0	100	.0430	.0314
1-000-0750	75.0	101	.0514	.0383
1-000-0800	80.0	93	.0565	.0413
1-000-1000	100.0	116	.0565	.0413
1-000-2000	200.0	127	.0710	.0557

*Available in "5" Pack 1-000-125-K.



HEMATO-CLAD® Mylar® Wrapped* Hematocrit Tubes

HEMATO-CLAD Hematocrit Tubes combine the precision of glass with the safety provided by a Mylar overwrap. Now, for the first time, you can give your laboratory staff enhanced safety with no compromise in accuracy. With HEMATO-CLAD Tubes the chance of contamination due to glass fragments or aerosols is greatly reduced. Accidental breakage is significantly reduced particularly when pressing the tube into sealing clay. In the event of breakage, the Mylar wrapping will help contain the sample (blood) and provides an added layer of protection against cuts from broken glass.

Note: HEMATO-CLAD Mylar Wrapped Hematocrit Tubes comply with FDA, NIOSH, CDC, and OSHA safety recommendations for the use of capillary tubes for blood collection.
www.fda.gov/cdrh/safety/capssa9.html

Cat. No.	Description	Package Size
1-000-7500-C/5	Plain (Blue)	1000/Case
1-000-7500-HC/5	Heparin Coated (Red)	1000/Case

*Patent Number 5,173,266

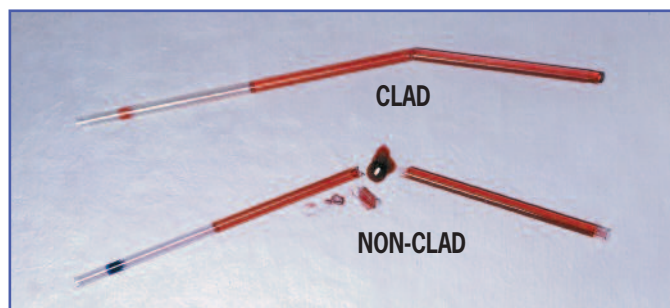

Plasticrit Plastic Hematocrit Tubes

Plasticrit Plastic Hematocrit Tubes provide the identical capillary action as glass hematocrit tubes. They eliminate the possibility of contamination due to breakage with no compromise in accuracy. These 75 mm polycarbonate pipets are available plain or heparinized.

Note: Plasticrit Hematocrit Tubes comply with FDA, NIOSH, CDC, and OSHA safety recommendations.

Cat. No.	Description	Package Size
8-000-7520/5	Plain	1000/case
8-000-7520-H/5	Heparin Coated	1000/case



Mylar is a registered trademark of DuPont

Ordering Information

Where to Order

All of the items listed in this catalog are available through most major laboratory supply distributors. For a list of dealers, either call Drummond or refer to our web site (www.drummondsci.com) for a complete list.

Drummond Scientific Company, 500 Parkway, P.O. Box 700, Broomall, PA 19008

800/523-7480, 610/353-0200, FAX: 610/353-6204

Shipping

Unless specified, most Drummond products are shipped by UPS, FOB Broomall, PA.

Terms: Net 30 days with established credit.

Returns

Returns are accepted prepaid, with prior authorization and are generally subject to a 15% restocking charge.

Export Orders

Drummond maintains a select group of foreign stocking dealers and/or can be of immediate assistance for foreign shipment. Refer to our web site for a list of our foreign dealers.

O.E.M.

Drummond is a major supplier of private labeled liquid handling equipment worldwide. We welcome the opportunity to discuss development and production of new items or adaptations of existing products.

Item	Page
Capillary Tubing	18
Captrol III®	19
Collection Tubes	18
HEMATO-CLAD® Hematocrit Tubes	22
Manifolds	15
Microcaps®	21
Microdispensers, Dialamatic	16
Microdispensers, Digital	14
Microdispensers, Fixed Volume	17
Micropipets, Calibrated	19
Nanoject II Auto/Oocyte Injector, Recording Nanoject II	10, 11
Pipet, Oocyte Microinjection	13
Pipets, PCR	21
Pipet, Sequencing	13
Pipet-Aid®, Original	9
Pipet-Aid®, Dual Pump Filtration	9
Pipet-Aid®, Hood Mate®	8
Pipet-Aid®, Original Portable	7
Pipet-Aid®, Portable XL	5
Pipet-Aid®, Portable XP	6
Pipet-Aid®, Portable XP2	4
Plasticrit Hematocrit Tubes	22
Repeat Kit	15
Tissue Culture Nosepiece, EZ Grip	3
Wiretrol® I and II	20



500 Parkway, Box 700
Broomall, PA 19008
1-800/523-7480
1-610/353-0200
FAX: 1-610/353-6204

www.drummondsci.com
www.pipet-aid.com

©Copyright, Drummond Scientific Co., 2012 Printed in USA
Tygon is a Registered Trademark of Norton
Nanoject II™ is a Trademark of Drummond Scientific Co.
HEMATO-CLAD, Pipet-Aid, Captrol III, Wiretrol I, Wiretrol II, Hood Mate,
and Microcaps are Registered Trademarks of Drummond Scientific Co.