



SKLAR

HOSPITAL CATALOG

GENERAL
SURGERY
EDITION

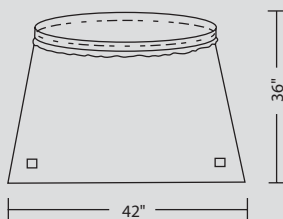


Complete Guide to the Care and Cleaning of Surgical Instruments See Pages 510-527

BAND BAGS WITH TAPE

NON-STERILE CASE / 100

PRODUCT NUMBER	FEATURES
96-5000	8" x 8"
96-1059	10" x 10"
96-5582	12" x 12"
96-5001	12" x 24"
96-5515	15" x 15"
96-5516	20" x 18"
96-5583	20" x 20"
96-1061	20" x 28"
96-5002	30" x 15"
96-1062	30" x 20"
96-5517	30" x 30"
96-5584	30" x 36"
96-5518	36" x 15"
96-5010	36" x 20"
96-5580	36" x 24"
96-1068	36" x 28"
96-5581	36" x 30"
96-5004	36" x 36"
96-5585	36" x 40"
96-5579	36" x 48"
96-5586	36" x 50"
96-1052	36" x 54"
96-5529	40" x 30"
96-5530	40" x 40"
96-5018	40" x 60"
96-5007	42" x 36"
96-5531	44" x 36"
96-1047	44" x 40"
96-5008	50" x 36"
96-5012	50" x 40"
96-5009	50" x 50"
96-5604	54" x 90"
96-5600	60" x 30"



LATEX-FREE

BAND BAGS WITH TAPE

SKLAR brand banded bags are available in both sterile and non-sterile. A multipurpose covering with an elastic opening. Quick and easy to fit over a variety of O.R. equipment.

STERILE CASE / 20

PRODUCT NUMBER	FEATURES
96-5013	8" x 8"
96-1069	10" x 10"
96-5591	12" x 12"
96-5014	12" x 24"
96-5522	15" x 15"
96-1072	20" x 18"
96-5592	20" x 20"
96-5016	20" x 28"
96-5015	30" x 15"
96-1073	30" x 20"
96-5524	30" x 30"
96-5593	30" x 36"
96-5588	36" x 15"
96-5023	36" x 20"
96-1057	36" x 24"
96-5603	36" x 28"
96-5590	36" x 30"

STERILE CASE / 20

PRODUCT NUMBER	FEATURES
96-5017	36" x 36"
96-5594	36" x 40"
96-5589	36" x 48"
96-5595	36" x 50"
96-5587	36" x 54"
96-5532	40" x 30"
96-5533	40" x 40"
96-5019	40" x 60"
96-5020	42" x 36"
96-1054	44" x 36"
96-5024	44" x 40"
96-5021	50" x 36"
96-1053	50" x 40"
96-5022	50" x 50"
96-5025	54" x 90"
96-5601	60" x 30"



MAYO STAND COVERS

NON-STERILE CASE / 100

PRODUCT NUMBER	FEATURES
96-5566	20" x 54"
96-5135	23" x 54"
96-1089	24" x 40.5" Clear
96-5567	30" x 57"
96-1091	36" x 72" Clear

NON-STERILE CASE / 50

PRODUCT NUMBER	FEATURES
96-5570	20" x 54"
96-5136	23" x 54"
96-1108	24" x 40.5" Clear
96-5571	30" x 57"
96-1093	36" x 72" Clear

STERILE CASE / 20

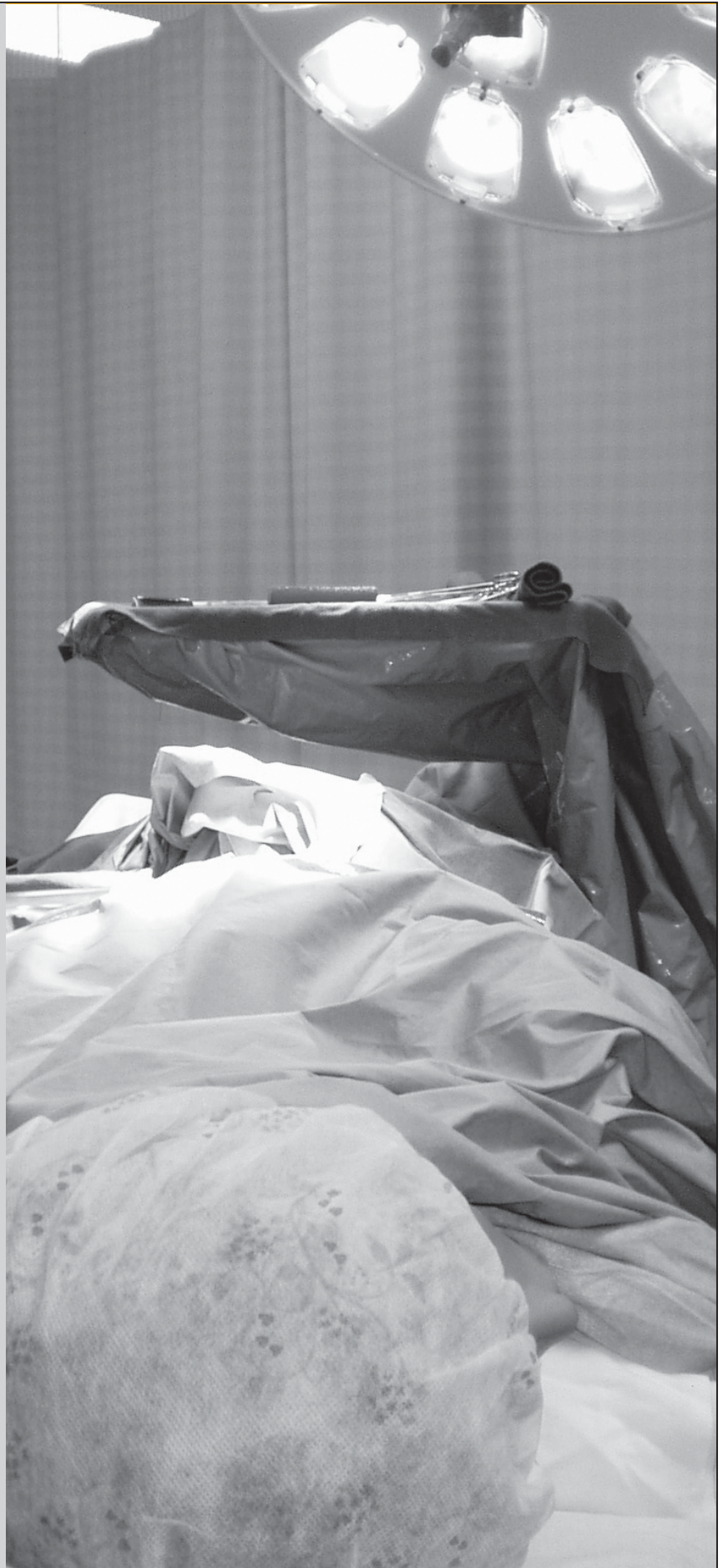
PRODUCT NUMBER	FEATURES
96-5574	20" x 54"
96-5137	23" x 54"
96-1094	24" x 40.5" Clear
96-5575	30" x 57"
96-1096	36" x 72" Clear

BULK, NON-STERILE

NON-STERILE

PRODUCT NUMBER	FEATURES/QUANTITIES
96-1131	20" x 54" 1000 Pcs
96-1132	23" x 54" 1000 Pcs
96-1133	24" x 40.5" Clear 1000 Pcs
96-1134	30" x 57" 800 Pcs
96-1135	36" x 72" Clear 800 Pcs

800.221.2166
www.SKILARCORP.com



DOMES COVERS

NON-STERILE CASE / 100

PRODUCT NUMBER	FEATURES
96-5050	14" Deep
96-1101	18" Deep
96-5053	22" Deep
96-5056	27" Deep
96-1109	30" Deep

NON-STERILE CASE / 50

PRODUCT NUMBER	FEATURES
96-5051	14" Deep
96-1103	18" Deep
96-5054	22" Deep
96-5057	27" Deep
96-1104	30" Deep

STERILE CASE / 20

PRODUCT NUMBER	FEATURES
96-5052	14" Deep
96-1106	18" Deep
96-5055	22" Deep
96-5058	27" Deep
96-1107	30" Deep



Sklar does not represent or warrant that the products it sells offer absolute protection from exposure to blood, contaminants, infectious diseases, or the risk of contracting infectious diseases. Consistent with OSHA requirements, employers assess each medical task to be performed and the type of blood or contaminant exposure that is expected. Employers then choose appropriate protective apparel for employees in order to prevent contamination of their skin or clothing.



BASIC ORTHOPEDIC SURGERY SET (98-1006)

PRODUCT NUMBER	DESCRIPTION	QUANTITY	PRODUCT NUMBER	DESCRIPTION	QUANTITY
98-1006	Complete Set		40-2485	Kern Forceps 8½" -----	1
06-2860	Metal Ruler 6" -----	1	40-2670	Lewin Bone Forceps Serr 7" -----	1
06-2903	Scalpel Handle #3 -----	1	40-2922	Lowman Clamp Small Jaw 1½" -----	1
06-2904	Scalpel Handle #4 -----	1	40-2925	Lowman Clamp 4¾" 1x1½" Jaw -----	1
11-1060	Lister Bandage Scissors Large Rng 8" -----	1	40-3177	Liston Bone Forceps Ang 7¾" -----	1
13-1055	Operating Scissors 5½" Str Sh/Sh -----	1	40-3710	Stille-Liston Bone Forceps Str 10½" -----	1
14-1055	Operating Scissors 5½" Str Sh/Bl -----	2	40-4270	Beyer Rongeur Cvd On Flat 7" -----	1
14-2055	Operating Scissors 5½" Cvd Sh/Bl -----	1	40-4272	Ruskin Rongeur Str 7¼" -----	1
15-1355	Stitch Scissors Standard 5½" -----	1	40-5780	Hajek Bone Mallet 8" -----	1
15-1567	Mayo Dissecting Scissors Str 6¾" -----	1	40-6667	Hibbs Osteotome 9½" x 10 mm -----	1
15-2567	Mayo Dissecting Scissors Cvd 6¾" -----	2	40-6668	Hibbs Osteotome 9½" x 13 mm -----	1
16-2800	S E Wire Cut Scissors Ang 4¾" T-C -----	1	40-6711	Hibbs Chisel 9½" x 10 mm -----	1
17-1772	Mixer Forceps Rt Ang 7¼" -----	4	40-6715	Hibbs Chisel 9½" x 13 mm -----	1
17-2055	Kelly Forceps Str 5½" -----	12	40-7400	Key Elevator 7½" x ¼" -----	1
17-2155	Kelly Forceps Cvd 5½" -----	12	40-7402	Key Elevator 7½" x ½" -----	1
17-2272	Roch-Pean Forceps Cvd 7¼" -----	3	40-9365	Sayre Elevator Blunt D/E 6½" -----	1
17-2472	Roch-Pean Forceps Str 7¼" -----	3	42-1765	Weitlaner-Beckman Retractor Sh 6" -----	1
19-1055	Dressing Forceps 5½" -----	2	42-1965	Weitlaner Retractor Sh 3x4 6½" -----	1
19-1080	Dressing Forceps 8" -----	2	47-2935	Backhaus Towel Clamp 3½" -----	4
19-1255	Tissue Forceps 1x2 5½" -----	2	47-2955	Backhaus Towel Clamp 5¼" -----	12
19-1280	Tissue Forceps 1x2 8" -----	2	50-2008	Frazier Suction Tube 8 Fr -----	1
21-8032	Mayo-Hegar Nh Serr 7" T-C -----	1	50-2010	Frazier Suction Tube 10 Fr -----	1
21-8033	Mayo-Hegar Nh Serr 8" T-C -----	1	50-2012	Frazier Suction Tube 12 Fr -----	1
36-2160	Allis Tissue Forceps 4x5 6" -----	2	55-7175	Hibbs Retractor 2" x 5/8" Bld 7½" -----	2
36-2275	Allis Tissue Forceps 5x6 7½" -----	2	60-6162	Senn Retractor D/E Sharp 6¼" -----	2
40-1775	Needle Nose Pliers 5½" -----	1	60-6164	Senn Retractor D/E Blunt 6¼" -----	2
40-2275	Bone/Cartilage Clamp Cvd 8" -----	1	75-5670	Metzenbaum Scissors Cvd 7" -----	1
40-2480	Kern Bone Forceps w/o Ratchet Xsm 5¾" -----	1			



LAMINECTOMY SET (98-1032)

PRODUCT NUMBER	DESCRIPTION	QUANTITY	PRODUCT NUMBER	DESCRIPTION	QUANTITY
98-1032	Complete Set		47-2955	Backhaus Towel Clamp 5 1/4" -----	12
06-2903	Scalpel Handle #3 -----	1	87-2195	Foerster Sponge Forceps Str Serr 9 1/2" -----	6
06-2904	Scalpel Handle #4 -----	1	42-3418	Love-Kerrison Rongeur 6" Upbite 5 mm -----	1
06-2907	Scalpel Handle #7 -----	1	42-3429	Love-Kerrison Rongeur 6" Downbite 5 mm -----	1
15-1567	Mayo Scissors Straight 6 3/4" -----	1	42-3150	Love-Gruenwald Rongeur 6" 2 x 10 mm -----	1
15-2567	Mayo Scissors Curved 6 3/4" -----	1	42-3156	Love-Gruenwald Rongeur Str 7" 3 x 10 mm -----	1
75-5570	Metzenbaum Scissors Curved 7" -----	1	42-3158	Love-Gruenwald Rongeur Upbite 7" 3 x 10 mm -----	1
14-1055	Operating Scissors S/B Straight 5 1/2" -----	1	42-3160	Love-Gruenwald Rongeur Downbite 7" 3 x 10 mm -----	1
14-2055	Operating Scissors S/B Curved 5 1/2" -----	1	40-7000	Spinal Currettes 8" 000 -----	1
19-1055	Dressing Forceps 5 1/2" -----	1	40-7100	Spinal Currettes 8" 00 -----	1
19-1080	Dressing Forceps 8" Serrated -----	2	40-7110	Spinal Currettes 8" 0 -----	1
19-1255	Tissue Forceps 5 1/2" 1 x 2 -----	1	40-7111	Spinal Currettes 8" 1 -----	1
19-1280	Tissue Forceps 8" 1 x 2 -----	2	40-7112	Spinal Currettes 8" 2 -----	1
22-6770	Cushing Forceps Serrated 7" -----	1	40-7113	Spinal Currettes 8" 3 -----	1
22-6870	Cushing Forceps 1 x 2 7" -----	1	40-7114	Spinal Currettes 8" 4 -----	1
50-3371	Adson Bayonet Forceps 7 1/2" Serrated -----	1	40-7115	Spinal Currettes 8" 5 -----	1
17-1450	Halsted Straight 5" -----	12	40-7116	Spinal Currettes 8" 6 -----	1
17-1550	Halsted Curved 5" -----	12	40-3670	Luer Rongeur Curved -----	1
17-3062	Crile Straight 6 1/4" -----	12	40-4092	Leksell Rongeur Std Wide -----	1
17-3162	Crile Curved 6 1/4" -----	12	40-3910	Horsley Rongeur D/A Angular -----	1
36-2260	Allis Tissue Forceps 5 x 6 6" -----	4	40-3985	Stille Luer Rongeur Straight -----	1
57-1322	Beckman-Adson Retractor Sharp -----	2	40-4090	Stille Luer Rongeur Angular -----	1
42-1975	Weitlaner Retractor 8" Sharp -----	2	40-3710	Stille Liston Bone Cutter Straight -----	1

BASIC EYE SURGERY SET (98-1034)

PRODUCT NUMBER	DESCRIPTION	QUANTITY	PRODUCT NUMBER	DESCRIPTION	QUANTITY
98-1034	Complete Set		64-2342	Castroviejo Scissors Corneal Left 4 1/2" -----	1
06-2903	Scalpel Handle #3 -----	1	65-6357	T-C Castroviejo Needle Holder Straight W/Lock -----	1
06-2907	Scalpel Handle #7 -----	1	66-2740	Eye Dressing Forceps Serrated Straight 4" -----	1
64-1342	Stevens Tenotomy Scissors Curved Blunt 4 1/2" -----	1	66-2940	Eye Dressing Forceps Serrated Straight 4" -----	1
64-1242	Stevens Tenotomy Scissors Straight Blunt 4 1/2" -----	1	66-3340	Eye Dressing Forceps 1 x 2 Straight 4" -----	1
47-1235	Iris Scissors Straight 3 1/2" -----	1	66-3540	Eye Dressing Forceps 1 x 2 1/2" Curved 4" -----	1
47-1135	Iris Scissors Straight 4 1/2" -----	1	66-5340	Arruga Capsule Forceps -----	1
47-1245	Iris Scissors Curved 4 1/2" -----	1	65-1535	Castroviejo Eye Speculum -----	1
18-1050	Halsted Mosquito Forceps Straight 5" Delciate -----	2	65-1532	Lancaster Eye Speculum -----	1
18-1150	Halsted Mosquito Forceps Curved 5" Delciate -----	4	65-1842	Demarres Lid Retractor #2 -----	1
64-2242	Castroviejo Scissors Corneal Right 4 1/2" -----	1	47-2955	Backhaus Towel Clamps 3 1/2" -----	1

TONSIL SET (98-1036)

PRODUCT NUMBER	DESCRIPTION	QUANTITY	PRODUCT NUMBER	DESCRIPTION	QUANTITY
98-1036	Complete Set		75-2161	Wieder Tongue Depressor Large -----	1
75-5570	Metzenbaum Scissors Curved 7" -----	1	74-3075	Schmidt Tonsil Hemostats -----	2
15-2567	Mayo Scissors Curved 6 3/4" -----	1	75-6387	Hurd Dissector & Pillar Retractor -----	1
75-1015	Jennings Mouth Gag Small -----	1	17-2262	Rochester-Pean Forceps Curved 6 1/4" -----	2
75-1016	Jennings Mouth Gag Medium -----	1	06-2907	Scalpel Handle #7 -----	1
75-1017	Jennings Mouth Gag Large -----	1	47-2955	Backhaus Towel Clamps 5 1/2" -----	1
36-2275	Allis Tissue Forceps 7 1/2" -----	1	87-2195	Sponge Forceps Serrated Straight 9 1/2" -----	1
07-1805	Yankauer Suction Tube Stainless -----	1	20-1270	Crile Wood Needle Holder 7" -----	1
74-2575	Tonsil Forceps White 7 1/2" -----	2	75-9612	Hartman Tonsil Punch -----	1
75-2160	Wieder Tongue Depressor Small -----	1	75-2320	Love Urula Retractor -----	1



MYRINGOTOMY SET (98-1038)

PRODUCT NUMBER	DESCRIPTION	QUANTITY	PRODUCT NUMBER	DESCRIPTION	QUANTITY
47-1145	Iris Scissors Straight Sharp/Sharp-----	1	50-1957	Baron Suction Tube 7 Fr -----	1
68-1765	Applicator Twist End 6½" -----	1	67-1150	Wilde Ear Forceps Delicate 5" -----	1
68-1865	Applicator Triangle End 6½" -----	1	67-2515	Buck Ear Curette Straight Sharp #0 -----	1
67-2005	Ear Knife -----	1	67-2516	Buck Ear Curette Straight Sharp #1 -----	1
67-6010	Boucheron Ear Speculum Set of 4 -----	1	67-2490	Buck Ear Curette Straight Blunt #0 -----	1
67-6025	Boucheron Ear Speculum Infant -----	1	67-2491	Buck Ear Curette Straight Blunt #1 -----	1
50-1953	Baron Suction Tube 3 Fr -----	1	67-1036	Hartman Ear Forceps Delicate 3½" -----	1
50-1955	Baron Suction Tube 5 Fr -----	1			

MCGIVNEY HEMORRHOID LIGATOR SET (80-1945)

PRODUCT NUMBER	DESCRIPTION	QUANTITY	PRODUCT NUMBER	DESCRIPTION	QUANTITY
80-1872	Sklar Hemorrhoid Forceps 7¼" -----	1	80-2245	Ives Rectal Speculum -----	1
80-1950	McGivney Hemorrhoid Ligator, Complete With Loading Cone and 100 "O" Rings -----	1			

WILSON VASECTOMY SET (85-6222)

PRODUCT NUMBER	DESCRIPTION	QUANTITY	PRODUCT NUMBER	DESCRIPTION	QUANTITY
85-6223	Vas Fixation Fcp 5" Oval Tip -----	1			
85-6224	Vas Piercing Fcp 5" -----	1			

COLPOSCOPY SET (90-8557)

PRODUCT NUMBER	DESCRIPTION	QUANTITY	PRODUCT NUMBER	DESCRIPTION	QUANTITY
90-6612	Kogan Endo Speculum - Wide Wire Blades -----	1	90-7520	Tischler Oval Biopsy Forcep - 3mm x 7mm Bite-----	1
85-6224	Kevorkian-Young Endo Crtte - 12" With Basket -----	1	90-8334	Emmet (Iris) Hook - 4mm Dia, 9" Long, Quick Release -----	1

BASIC NAIL SET (98-1009)

PRODUCT NUMBER	DESCRIPTION	QUANTITY	PRODUCT NUMBER	DESCRIPTION	QUANTITY
97-1046	Nail Nipper Barrel Spring 5½" -----	1	97-1262	Littauer Cutting Forceps 6" -----	1
97-1242	Tissue Nippers 4½" -----	1	97-1662	Nail Splitter Tapered Jaw 5" -----	1
97-1255	Littauer Cutting Forceps 4 ½" -----	1			



BASIC TOTAL HIP SET (98-1011)

PRODUCT NUMBER	DESCRIPTION	QUANTITY	PRODUCT NUMBER	DESCRIPTION	QUANTITY
98-1011	Complete Set		40-6666	ibbs Osteotome 6 mm 9½" -----	1
06-2860	Metal Ruler 6"-----	1	40-6667	Hibbs Osteotome 10 mm 9½" -----	1
06-2904	Scalpel Handle #4 -----	2	40-6668	Hibbs Osteotome 13 mm 9½" -----	1
06-2907	Scalpel Handle #7 -----	1	40-6855	Bone Hook "T" Handle Large" -----	1
07-1805	Yankauer Suction Tube -----	1	40-7451	Mini Hohmann Bone Elevator 8 mm 6½" -----	1
15-1567	Mayo Dissecting Scissors Str 6¾" -----	1	40-7453	Hohmann Bone Elevator 43 mm 10¾" -----	1
15-2567	Mayo Dissecting Scissors Cvd 6¾" -----	1	40-7455	Hohmann Bone Elevator 20 mm 10¾" -----	1
17-1450	Halsted Mosquito Forceps Str 5" -----	6	40-9712	Putti Bone Rasp Flat End / Conic End 12" -----	1
17-2280	Rochester-Pean Forceps Cvd 8" -----	2	42-1965	Weitlaner Retractor 3 x 4 Prongs Sharp 6½" -----	2
17-2880	Rochester-Ochsner Forceps Str 8" -----	2	47-2935	Backhaus Towel Clamp 3½" -----	6
17-3162	Crile Forceps Cvd 6¼" -----	6	47-2955	Backhaus Towel Clamp 5¼" -----	2
19-1255	Tissue Forceps 1 x 2 Teeth 5½" -----	2	50-1472	Adson Forceps Cvd 7¼" -----	4
19-1655	Tissue Forceps 3 x 4 Teeth 5½" -----	2	55-7175	Hibbs Retractor 2" x 5/8" Blade 9" -----	2
19-2280	Russian Tissue Forceps 8" -----	2	55-9080	Metzenbaum Scissors Cvd 8" -----	1
20-1270	Crile-Wood Needle Holder (DeBakey) 7" -----	2	60-1699	Richardson-Eastman Retractor Dble End Sm -----	1
20-2480	Mayo-Hegar Needle Holder 8" -----	2	60-5604	olkman Retractor 4 Prong Sharp 8½" -----	2
36-2275	Allis Tissue Forceps 5 x 6 Teeth 7½" -----	2	60-5606	Volkman Retractor 6 Prong Sharp 8½" -----	2
40-3188	Beyer Rongeur Cvd 7" -----	1	60-6570	Gelpi Retractor 7" -----	1
40-3985	Stille-Luer Bone Rongeur Str 8½" -----	1	75-5670	Metzenbaum Scissors Cvd 7" -----	1
40-4085	Stille-Luer Bone Rongeur Cvd 8½" -----	1	87-2195	Foerster Sponge Forceps Str Serr 9½" -----	2
40-5765	Gerzog Bone Mallet 7½" -----	1	90-1690	Mayo Dissecting Scissors Cvd 9" -----	1

KNEE SET (98-1013)

PRODUCT NUMBER	DESCRIPTION	QUANTITY	PRODUCT NUMBER	DESCRIPTION	QUANTITY
98-1013	Complete Set		40-7400	Key Elevator ¼" x 7½" -----	1
06-2903	Scalpel Handle #3 -----	2	40-7402	Key Elevator ½" x 7½" -----	1
06-2904	Scalpel Handle #4 -----	1	40-8250	Blount Knee Retractor -----	2
06-2907	Scalpel Handle #7 -----	1	40-8272	Adson Elevator Round 6¾" -----	1
11-1055	Lister Bandage Scissors 5½" -----	1	40-9685	Bone File 8½" -----	1
15-1567	Mayo Dissecting Scissors Str 6¾" -----	2	41-1120	Martin Scissors Heavy Serr 7¾" -----	1
15-2567	Mayo Dissecting Scissors Cvd 6¾" -----	1	47-2380	Freer Elevator Double End 7¼" -----	1
17-2655	Rochester-Ochsner Forceps Cvd 5½" -----	2	47-2955	Backhaus Towel Clamp 5¼" -----	6
17-2662	Rochester-Ochsner Forceps Cvd 6¼" -----	4	47-3415	Downing Cartilage Knife 10" -----	1
17-3055	Crile Forcep Str 5½" -----	4	47-3420	Smillie Cartilage Knife Str 6¾" -----	1
17-3162	Crile Forcep Cvd 6¼" -----	4	47-3422	Smillie Cartilage Knife Left 6¾" -----	1
19-1255	Tissue Forceps 1 x 2 Teeth 5½" -----	2	47-3424	Smillie Cartilage Knife Right 6¾" -----	1
19-1655	Tissue Forceps 3 x 4 Teeth 5½" -----	2	50-2008	Frazier Suction Tube 8 French -----	1
20-1270	Crile-Wood Needle Holder (DeBakey) 7" -----	2	60-1085	US Army Retractor (Set of 2) 8½" -----	1
22-8255	Weitlaner Retractor 3 x 4 Prong Sharp 5½" -----	2	60-5602	Volkman Retractor 2 Prong Sharp 8½" -----	2
36-2060	Allis Tissue Forceps 3 x 4 Teeth 6" -----	4	60-5604	Volkman Retractor 4 Prong Sharp 8½" -----	2
40-2275	Bone/Cartilage Clamp Cvd 8" -----	1	60-6164	Senn Retractor Double End Blunt 6¼" -----	2
40-2290	Smillie Meniscus Hook 5¾" -----	1	75-5670	Metzenbaum Scissors Cvd 7" -----	1
40-2660	Dingman Bone/Cartilage clamp Small -----	1	98-2047	Micro Adson Forceps 1 x 2 Teeth 4¾" -----	2



BASIC DERMAL INSTRUMENT SET (98-1058)

PRODUCT NUMBER	DESCRIPTION	QUANTITY	PRODUCT NUMBER	DESCRIPTION	QUANTITY
98-1058	Complete Set		30-1945	Probe w/ Eye 4½" -----	1
06-4120	Shamberg Comedone Extractor -----	1	30-1955	Probe w/ Eye 5½" -----	1
06-4125	Unna Comedone Extractor 5¾" -----	1	36-2060	Allis Tissue Forceps 3 x 4 Teeth 6" -----	1
11-1045	Lister Bandage Scissors 4½" -----	1	36-2275	Allis Tissue Forceps 5 x 6 Teeth 7½" -----	1
11-1055	Lister Bandage Scissors 5½" -----	1	47-1145	Iris Scissors Str 4½" -----	1
15-1555	Mayo Dissecting Scissors Str 5½" -----	1	47-1245	Iris Scissors Cvd 4½" -----	1
15-2555	Mayo Dissecting Scissors Cvd 5½" -----	1	47-1246	Iris Scissors Del Str 4½" -----	1
17-1235	Hartmann Mosquito Forceps Str 3½" -----	1	47-1248	Iris Scissors Del Cvd 4½" -----	1
17-1335	Hartmann Mosquito Forceps Cvd 3½" -----	1	47-1360	Metzenbaum Scissors Cvd 5¾" -----	1
17-1450	Halsted Mosquito Forceps Str 5" -----	1	47-2047	Adson Tissue Forceps 1 x 2 Teeth Del 4¾" -----	1
17-1550	Halsted Mosquito Forceps Cvd 5" -----	1	47-2147	Adson Dressing Forceps Del Serr 4¾" -----	1
19-1055	Dressing Forceps Serrated 5½" -----	1	47-2935	Backhaus Towel Clamp 3½" -----	1
19-1255	Tissue Forceps 1 x 2 Teeth 5½" -----	1	47-2955	Backhaus Towel Clamp 5¼" -----	1
19-3035	Splinter Forceps 3½" -----	1	50-3047	Adson Tissue Forceps 1 x 2 Teeth 4¾" -----	1
19-3045	Splinter Forceps 4½" -----	1	50-3147	Adson Dressing Forceps Serr 4¾" -----	1
20-1350	Webster Needle Holder Del Smooth 5" -----	1	64-1242	Stevens Tenotomy Scissors Str 4½" -----	1
20-1352	Webster Needle Holder Del Serr 5" -----	1	64-1342	Stevens Tenotomy Scissors Cvd 4½" -----	1
20-1547	Derf Needle Holder Serr 4¾" -----	1	67-2502	Buck Curette Angled Sharp #2 -----	1
20-1750	Halsey Needle Holder Smooth 5" -----	1	67-2517	Buck Curette Str Sharp #2 -----	1
20-1751	Halsey Needle Holder Serr 5" -----	1	74-1370	Ballenger Sponge Forceps Str Smooth 7" -----	1
20-2747	Olsen-Hegar Needle Holder 4¾" -----	1	74-1670	Ballenger Sponge Forceps Cvd Serr 7" -----	1
20-2755	Olsen-Hegar Needle Holder 5½" -----	1	75-5460	Metzenbaum Scissors Str 5¾" -----	1

BASIC TISSUE DISSECTION SET (98-1064)

PRODUCT NUMBER	DESCRIPTION	QUANTITY	PRODUCT NUMBER	DESCRIPTION	QUANTITY
98-1064	Complete Set		24-2155	Healy Suture Forceps 5½" -----	1
06-2903	Scalpel Handle #3 -----	1	47-1145	Iris Scissors Str 4½" -----	1
06-3011	Surgical Blades #11 (Box of 100) -----	1	47-1235	Iris Scissors Cvd 3½" -----	1
06-3015	Surgical Blades #15 (Box of 100) -----	1	47-2047	Adson Tissue Forceps 1 x 2 Teeth 4¾" -----	1
17-1650	Halsted Mosquito Forceps 1 x 2 Teeth Str 5" -----	1	47-2147	Adson Dressing Forceps Serr 4¾" -----	1
18-1050	Halsted Mosquito Forceps Str 5" -----	3	47-2502	Joseph Skin Hook Sharp 2 Prong 2 mm -----	1
18-1150	Halsted Mosquito Forceps Cvd 5" -----	3	47-2505	Joseph Skin Hook Sharp 2 Prong 5 mm -----	1
20-1750	Halsey Needle Holder Smooth 5" -----	1	47-2570	Gilles Skin Hook 3 mm 7" -----	1
22-1163	Dressing Forceps Del Str 5½" -----	1	47-2572	Gilles Skin Hook 4 mm 7" -----	1
22-2545	Dissecting Scissors Del Cvd 4¾" -----	1	64-3280	Gradle Dissecting Scissors Sharp 3¾" -----	1
22-2652	Ragnell Dissecting Scissors Cvd 5" -----	1	65-1841	Desmarres Retractor Small 5½" -----	1
22-2947	Northbent Suture Scissors 4¾" -----	1	66-3540	Tissue Forceps Half Curved 1 x 2 Teeth 4" -----	1



BASIC NASAL SET (98-1091)

PRODUCT NUMBER	DESCRIPTION	QUANTITY	PRODUCT NUMBER	DESCRIPTION	QUANTITY
98-1091	Complete Set		47-1058	Wagner Sciss Cvd S/S Sm 4½".....	1
06-2907	Scalpel Handle #7	1	47-2500	Joseph Hook 1/Pr Sh 6¼"	1
06-2910	Scalpel Hand #3 W/Metric Scale	1	47-2502	Joseph Hook 2/Pr Sh 6¼" 2Mm	1
07-1805	Yankauer Suct Tube Stainless.....	1	47-2507	Joseph Hook 2/Pr Sh 6¼" 7Mm	1
16-1605	S E Mayo Dis Sciss Cvd 5½" Tc	1	47-2935	Backhaus Towel Clamp 3½"	4
16-1905	S E Metz Lahey Crv Del 5¾" Tc.....	1	50-2007	Frazier Suct Tube 7Fr	2
16-2105	S E Metz Sciss Cvd Del 7 Tc	1	50-3047	Adson Tissue Fcp 1X2 4¾"	2
17-1450	Halsted Mosq Fcp Str 5"	6	60-1085	Us Army Retr Set/2 D/E 8¼"	1
21-8001	Halsey Nh Serr Tc 5¼"	1	60-6162	Senn D/E Retractor Sharp 6"	2
22-6157	Allis Tiss Del Fcp 4X5 5½"	2	66-1940	Graefe Fix Fcp W/O Cat 4½"	1
41-1050	Joseph Scissors Str 5¾"	1	68-1765	Farrell Applicator Twist 6½"	1
41-1054	Joseph Scissors Cvd 5¾"	1	70-1030	Killian Med W/Set Screw 3"	1
41-1198	Laser Cottle Septal Spec 2"	1	70-1071	Vienna Child Size.....	1
41-1410	Aufricht Retr Solid Bld 6 ½"	1	70-4470	Wilde Ear/Nsl Fcp Serr Ang 7"	1

MAJOR NASAL SET (98-1092) USED WITH BASIC NASAL SET

PRODUCT NUMBER	DESCRIPTION	QUANTITY	PRODUCT NUMBER	DESCRIPTION	QUANTITY
98-1092	Complete Set		47-2500	Joseph Hook 1/Pr Sh 6¼"	1
06-2860	Steel Ruler 6"	1	47-2505	Joseph Hook 2/Pr Sh 6¼" 5Mm.....	2
16-1905	S E Metz Lahey Crv Del 5¾" Tc.....	1	47-2570	Gillies Skin Hook 7" 3Mm	1
16-2105	S E Metz Sciss Cvd Del 7 Tc	1	50-3147	Adson Dressing Fcp Serr 4¾"	1
21-8007	Crile Wood Nh Serr 7" Tc	1	64-1442	Strabismus Sciss Str 4½"	1
40-5870	Sklar Mallet W/Repl Plst Discs	1	64-1542	Strabismus Sciss Crv 4½"	1
40-9815	Maltz Rasp 7" Bkd Cut	1	65-1841	Desmarres Lid Retr 12Mm	1
40-9825	Joseph Rasp Fine Crss Serr 6¼"	1	65-6732	Castroviejo Caliper 3¼"	1
40-9841	Aufricht Glabellar Rasps 8" Bkd.....	1	66-1040	Cottle Columella Fcp 4½"	1
41-1169	Cottle Dorsal Sciss Ang 6½"	1	67-1050	Hartman Ear Fcp Light Serr Jaw	1
41-1198	Laser Cottle Septal Spec 2"	2	67-1465	Jansen Nasal Fcp Bayonet 6½"	1
41-1235	Cottle Elev Cm-Grad D/E 9	1	67-4622	Sheehan Osteo Str 6¼" 4Mm.....	1
41-1240	Joseph Perio Elev 7" X6.5Mm.....	1	67-4626	Sheehan Osteo Str 6¼" 8Mm	1
41-1245	Joseph Perio Elev 6¼" X4.5Mm.....	1	67-4628	Sheehan Osteo Str 6¼" 10Mm	1
41-1255	Cottle Nasal Knife Sh 5½" 4Mm	1	67-4630	Sheehan Osteo Str 6¼" 12Mm	1
41-1340	Cottle Nasal Osteo 6½" Cvd	1	70-1030	Killian Med W/Set Screw 3"	1
41-1370	Cinelli Osteo Grd 2Sd Str 10Mm	1	70-4352	Foman Nas Low Lat Scis Cv 5¾"	1
41-1382	Cot Knife Grd/Retr 8" 5Mm Hook.....	1	70-5190	Ash Sept Straightening Fcp 9"	1
41-1383	Neiv Knife Gd/Retr 6½" D-End	1	70-7504	Ballenger Swivel Knife 4Mm	1
41-1385	Cottle Ret 5½" 4Prng 2Reces	1	70-7805	Joseph Bone Saw Str 7½"	1
41-1396	Fomon Retr Ball End Dbl 6¼"	1	74-3075	Schmidt Half Crv Tons Fcp 7½"	2
41-1398	Converse Alar Retr D/E 4½"	1	97-1505	Maltz Rasp Se Fine Tc.....	1
47-1135	Iris Sciss Str S/S 3½"	1	97-1506	Maltz Rasp Se Medium Tc	1
47-2380	Freer Elevator De Sh/BI 7¼"	1			



BASIC EAR SET (98-1093)

PRODUCT NUMBER	DESCRIPTION	QUANTITY	PRODUCT NUMBER	DESCRIPTION	QUANTITY
98-1093	Complete Set		50-2009	Frazier Suction Tube 9 Fr	1
06-2910	Scalpel Hand #3 W/Metric Scale	1	50-3047	Adson Tissue Fcp 1 X 2 4 ³ / ₄ "	1
16-1605	S E Mayo Dis Sciss Cvd 5 ¹ / ₂ " Tc	1	50-3147	Adson Dressing Fcp Serr 4 ³ / ₄ "	1
16-1905	S E Metz Lahey Crv Del 5 ³ / ₄ " Tc	1	60-1891	Langenbeck Retr Sm 9"	1
16-2105	S E Metz Sciss Cvd Del 7 Tc	1	60-1892	Langenbeck Retr Med 9"	1
17-1450	Halsted Mosq Fcp Str 5"	6	60-6162	Senn D/E Retractor Sharp 6"	2
17-2055	Kelly Fcp Str 5 ¹ / ₂ "	2	60-6320	Allport Retr Sharp 4"	1
21-8001	Halsey Nh Serr Tc 5 ¹ / ₄ "	1	64-1542	Strabismus Sciss Crv 4 ¹ / ₂ "	1
24-2342	Sut Wire Cut Scis Ser Ang 4 ³ / ₄ "	1	66-1940	Graefe Fix Fcp W/O Cat 4 ¹ / ₈ "	1
36-2160	Allis Tiss Fcp 4 X 5 6"	2	67-1465	Jansen Nasal Fcp Bayonet 6 ¹ / ₂ "	1
42-1824	Wullstein Endaur Ret 3 X 3 Sh 5"	1	67-2514	Buck Ear Curette Sh Str #00	1
47-2380	Freer Elevator De Sh/BI 7 ¹ / ₄ "	1	67-2516	Buck Ear Curette Sh Str #1	1
47-2500	Joseph Hook 1/Pr Sh 6 ¹ / ₄ "	2	67-6011	Boucheron Ear Spec 5Mm Chrome	1
47-2832	Jansen Retractor Blunt 3 X 3 4"	1	67-6012	Boucheron Ear Spec 6Mm Chrome	1
47-2935	Backhaus Towel Clamp 3 ¹ / ₂ "	4	67-6013	Boucheron Ear Spec 7Mm Chrome	1
50-2007	Frazier Suct Tube 7 Fr	1	67-6014	Boucheron Ear Spec 8Mm Chrome	1

CATARACT SURGERY SET (98-1094)

PRODUCT NUMBER	DESCRIPTION	QUANTITY	PRODUCT NUMBER	DESCRIPTION	QUANTITY
98-1094	Complete Set		65-1842	Desmarres Lid Retr 14Mm	1
06-2907	Scalpel Handle #7	1	65-2960	Troutman Blade Breaker	1
06-2910	Scalpel Hand #3 W/Metric Scale	1	65-3216	Graefe Strabismus Hook Med	1
21-8040	Castro Nh W/Lk Str Sm 5 ¹ / ₂ " Tc	1	65-3216	Graefe Strabismus Hook Med	1
21-8043	Castro Nh W/Lk Cvd Del 5 ¹ / ₂ " Tc	1	65-4062	Castro Cyclodial Spat .5Mm	1
22-1241	Stevens Tenot Del Crv S/S 4 ¹ / ₂ "	1	65-6732	Castroviejo Caliper 3 ¹ / ₄ "	1
23-2505	Sklarlite Xd Halst Mosq 5" St"	4	65-7635	Fox Aluminum Eye Shield	2
23-2506	Sklarlite Xd Halst Mosq Cvd 5	6	65-8216	Wilder Lens Scoop Smooth	1
47-1135	Iris Sciss Str S/S 3 ¹ / ₂ "	1	65-9085	Kirby Hook & Expressor De 14.5	1
47-1235	Iris Sciss Cvd S/S 3 ¹ / ₂ "	1	66-1036	Desmarres Chal Fcps 3 ¹ / ₂ " Med	1
47-2935	Backhaus Towel Clamp 3 ¹ / ₂ "	4	66-1940	Graefe Fix Fcp W/O Cat 4 ¹ / ₈ "	1
64-1735	Wilmer Sciss 4" Ang On Flat "	1	66-2440	Obrien Fix Del 4"	1
64-1950	Vannas Sciss Str Del 3"	1	66-2640	Castro Fix Fcp .3Mm 1 X 2 4"	1
64-2242	Castroviejo Corneal Rght 4 ¹ / ₄ "	1	66-2740	Eye Dress Fcp Str Serr 4"	1
64-2342	Castroviejo Corneal Lft 4 ¹ / ₄ "	1	66-2940	Eye Dress Fcp 1 ¹ / ₂ " Crv Serr 4"	1
64-3050	Iris Micro-Min Sciss Str 4" X del"	1	66-3240	Eye Tiss Fcps 1 X 2 Str 4"	1
64-3142	Westcott Tenotomy Sciss 5" Rt	1	66-3340	Eye Tissue Fcp 1 X 2 Str 4"	1
64-3280	Gradle Sciss Sl Cvd Sh 3 ³ / ₄ "	1	66-5340	Arruga Capsule Fcps 4"	1
64-3294	Castroviejo Corneal Sciss 4" Rt	1	66-5342	Fcp Arruga Capsule 4" New Curve	1
64-3296	Castroviejo Corneal Sciss 4" Lt	1	66-6105	Castro Suture Fcp Str 4" X .5Mm	1
65-1528	Park-Maumenee Eye Speculum	1	66-7261	Fcp Colibri Corneal Util .4Mm	1
65-1532	Lancaster Eye Speculum 3 ¹ / ₄ "	1	97-1450	#3K Handle/Mini Podiatry Blades	1
65-1535	Castroviejo Spec 3 ¹ / ₂ "	1			



BREAST AUGMENTATION/REDUCTION SET (98-1095)

PRODUCT NUMBER	DESCRIPTION	QUANTITY	PRODUCT NUMBER	DESCRIPTION	QUANTITY
98-1095	Complete Set		47-2505	Joseph Hook 2/Pr Sh 6¼" 5Mm	1
06-2860	Steel Ruler 6"	1	47-2935	Backhaus Towel Clamp 3½"	4
06-2908	Round Scalpel Handle Straight	2	50-2008	Frazier Suct Tube 8 Fr	1
10-1497	Emesis Basin 10 oz	1	50-3047	Adson Tissue Fcp 1 X 2 4¾"	2
15-2567	Mayo Diss Sciss Cvd 6¾"	1	50-3147	Adson Dressing Fcp Serr 4¾"	1
17-1235	Hartmann Mosq Str Serr 3½"	4	52-5177	Debakey Atra Fcp 2Mm 7¾"	1
17-1450	Halsted Mosq Fcp Str 5"	2	60-1085	Us Army Retr Set/2 D/E 8¼"	2
17-2855	Kocher Fcps Str 1 X 2 5½"	2	60-3312	Deaver #4 2 X 12	2
19-1245	Tissue Fcp 1 X 2 4½"	2	60-3596	Zalkind Ribbon Retr ½" X 7.75"	3
20-1350	Webster Nh Smooth Jaw 5¼"	2	60-6162	Senn D/E Retractor Sharp 6"	1
20-1450	Baumgartner Nh Serr 5½"	2	64-1242	Stev Tenot Sciss Str 4½" Bb	1
20-2755	Olsen Hegar Nh 5½"	3	64-1342	Stev Tenot Sciss Crv 4½" Bb	1
20-4682	Heaney Nh 8¼"	1	65-4107	Bowman Lach Probe Sz 7/8" Chrome	1
22-2520	Goldman-Fox Sciss 5" Cvd Serr	1	74-3075	Schmidt Half Crv Tons Fcp 7½"	1
36-2160	Allis Tiss Fcp 4 X 5 6"	2	75-5570	Metzenbaum Scissors Str 7"	1
47-1145	Iris Sciss Str S/S 4½"	1	75-5670	Metzenbaum Scissors Cvd 7"	1
47-1245	Iris Sciss Cvd S/S 4½"	1	91-6100	Bipolar Adson Fcp 1Mm 4¾"	1
47-2502	Joseph Hook 2/Pr Sh 6¼" 2Mm	1			

BLEPHAROPLASTY SET (98-1096)

PRODUCT NUMBER	DESCRIPTION	QUANTITY	PRODUCT NUMBER	DESCRIPTION	QUANTITY
98-1096	Complete Set		22-2653	Ragnell Sciss Str 5"	1
06-2860	Steel Ruler 6"	1	47-2502	Joseph Hook 2/Pr Sh 6¼" 2Mm	2
06-2910	Scalpel Hand #3 W/Metric Scale	1	47-2935	Backhaus Towel Clamp 3½"	4
15-3585	SklarCut Iris Sciss Str S/S 4½"	1	50-3047	Adson Tissue Fcp 1 X 2 4¾"	1
15-3590	SklarCut Iris Sciss Crv S/S 4½"	1	65-1842	Desmarres Lid Retr 14Mm	1
17-1450	Halsted Mosq Fcp Str 5"	2	65-6732	Castroviejo Caliper 3¼"	1
17-1550	Halsted Mosq Fcp Cvd 5"	2	66-4132	Bishop-Harmon Eye Fcp 1 X 2 3.5"	1
21-8002	Webster Nh Smooth 5¼" Tc	2			

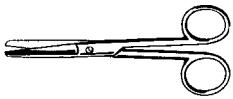
RHYTIDECTOMY / FACELIFT SET (98-1097)


PRODUCT NUMBER	DESCRIPTION	QUANTITY	PRODUCT NUMBER	DESCRIPTION	QUANTITY
98-1097	Complete Set		22-2835	Spencer Stitch Sciss 3½"	1
06-2860	Steel Ruler 6"	1	36-2160	Allis Tiss Fcp 4 X 5 6"	2
06-2907	Scalpel Handle #7	1	41-1105	Rhytidectomy Scis D/E Cvd 6½"	1
06-2910	Scalpel Hand #3 W/Metric Scale	1	47-1147	Blepharoplas Sci Crv Ser 4¾"	1
15-3549	Sklet Castanares Fclft Str 6¼"	1	47-1447	Adson Brown Tiss Sd Grasp 4¾"	1
15-3585	Sklet Iris Sciss Str S/S 4½"	1	47-2510	Joseph Hook 2/Pr Sh 6¼" 10Mm	2
15-3590	Sklet Iris Sciss Crv S/S 4½"	1	47-2935	Backhaus Towel Clamp 3½"	2
16-1510	S E Mayo Dis Sciss Str 6¾" Tc	1	47-2955	Backhaus Towel Clamp 5¼" 2	
16-1905	S E Metz Lahey Crv Del 5¾" Tc	1	50-2008	Frazier Suct Tube 8 Fr	1
17-1450	Halsted Mosq Fcp Str 5"	2	50-3047	Adson Tissue Fcp 1 X 2 4¾"	1
17-1550	Halsted Mosq Fcp Cvd 5"	2	52-3370	Potts-Smith Tiss Fcp 1 X 2 7"	1
21-8002	Webster Nh Smooth 5¼" Tc	1	52-5062	Debakey Atra Fcp 6¼" 1.5Mm	1
21-8006	Crile Wood Nh Serr Nar/Jw 6" Tc	1	52-5162	Debakey Atra Fcp Str 6¼" 2Mm	1
21-8080	Webster Nh Serr 5¼" Tc	2	60-1085	Us Army Retr Set/2 D/E 8¼"	2
22-1063	Tissue Fcp Del 1X2 5½"	1	60-1676	Richardson W/Sklrgrp Hndl Smll	1
22-1162	Dress Fcp Del Serr 5"	1	60-2812	Deaver Skl Gr Hdl #3 1½" X 12"	1
22-2653	Ragnell Sciss Str 5"	1	60-6162	Senn D/E Retractor Sharp 6"	2

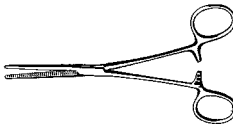


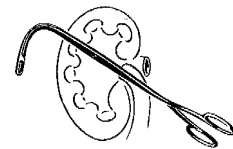
TABLE OF CONTENTS




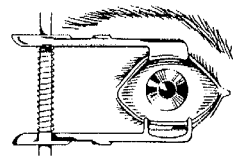
SCISSORS 6-37	
-------------------------	---


DIRECTORS & PROBES 121-122	
--	---

GENERAL FORCEPS 38-65	
---------------------------------	---

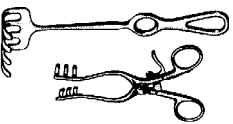
GALL BLADDER & KIDNEY INSTRUMENTS	
--	---

DRESSING & TISSUE FORCEPS 66-85	
---	---


EYE INSTRUMENTS 128-175	
-----------------------------------	---

NEEDLE HOLDERS 88-99	
--------------------------------	---


EAR INSTRUMENTS 176-184	
-----------------------------------	---

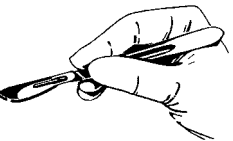
RETRACTORS 100-116	
------------------------------	---



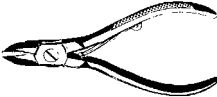
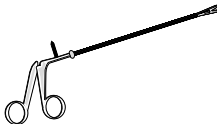


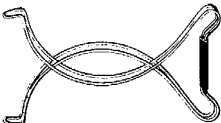

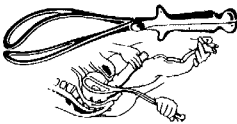


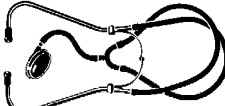
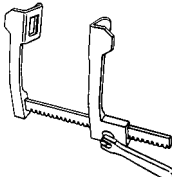

NASAL & NASAL PLASTIC INSTRUMENTS	
--	---

SUCTION TUBES 117-118	
---------------------------------	---

MOUTH & THROAT INSTRUMENTS 197-206	
--	---

SUTURE INSTRUMENTS 119-120	
--------------------------------------	---

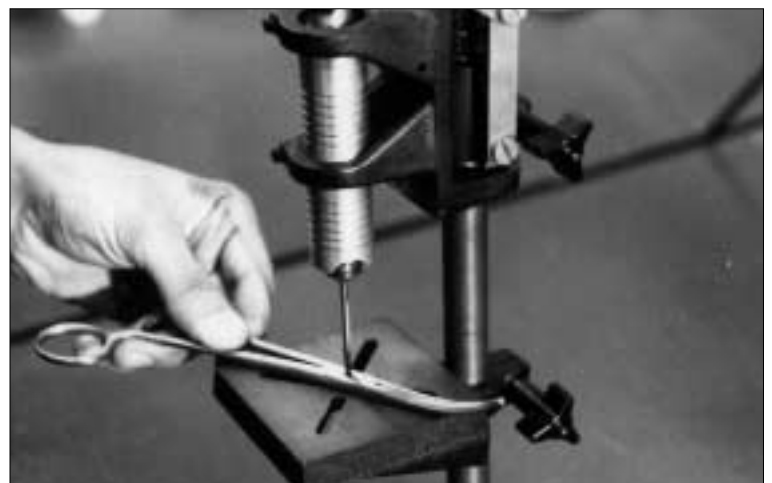
SCALPELS 208-210	
----------------------------	---

ORTHOPEDIC & PLASTER INSTRUMENTS		CARDIOVASCULAR INSTRUMENTS 393-433	
PODIATRY INSTRUMENTS 260-292		ENDOSCOPY/ ARTHROSCOPY 434-460	
RECTAL INSTRUMENTS 293-300		SKLARLITE™ INSTRUMENTS 461-474	
GENITO-URINARY INSTRUMENTS 301-306		MICRO INSTRUMENTS 475-492	
OBSTETRICAL GYNECOLOGICAL INSTRUMENTS		DERMAL INSTRUMENTS 493-496	
GYNECOLOGICAL ELECTROSURGERY/LASER INSTRUMENTS		DIAGNOSTIC INSTRUMENTS 497-500	
THORACIC 375-392		INSTRUMENT CLEANING & STERILIZING PRODUCTS	



Insist On Sklar Quality!

Every Sklar Instrument is thoroughly scrutinized so that even the most minute defect will be detected. No instrument leaves our warehouse until it is thoroughly inspected.





Sklar Is Proud
Of Our People

Our
Customer
Service Is
Unequaled In
The Industry

Sklar has the best customer support in the industry. Each representative is thoroughly trained and knowledgeable. Our team of professionals is ready to give their personal attention to your questions and needs. Please call us with your special requirements.

***At Sklar—Service Is Our
Top Priority!***

Hospital Catalog

Hotline For Technical Assistance

1-800-822-0124

889 South Matlack Street • West Chester, PA 19382

610-430-3200 • Order Fax: 610-696-9007

CLEANING & STERILIZING PRODUCTS



SKLAR SOAK

Instrument Immersion Solution
Liquid

- 10-1602 Case of 12, 8 Oz. Bottles
- 10-1603 Case of 4, 1 Gallon
- 10-1604 5 Gallon Container



SKLAR KLEEN

Detergent Powder

- 10-1606 Case of 6, 2 Lb. Jars
- 10-1630 Case of 6, 3 1/2 Lb. Pitcher
- 10-1631 Case of 6, 3 1/2 Lb. Jars



SKLAR KLEEN

Detergent Powder

- 10-1607 5 Lb. Pail
- 10-1608 30 Lb. Pail
- 10-2780 60 Lb. Drum
- 10-1632 100 Lb. Drum



SKLAR KLEEN LIQUID

Detergent

- 10-1612 Case of 6, 8 Oz. liquid bottles
- 10-1613 Case of 4, 1 Gallon
- 10-1614 5 Gallon Container



SKLAR KLEEN LF

Low Foam (Liquid) Detergent

- 10-2701 Case of 4, 1 Gallon
- 10-2705 5 Gallon Jug
- 10-2730 30 Gallon Container
- 10-2755 55 Gallon Drum



SKLAR ENZYMATIC

Detergent

- 10-2770 Case of 6, 1 Quart
- 10-2775 Case of 2, 1 Gallon
- 10-2777 Case of 4, 1 Gallon



SKLAR LUBE

Liquid

- 10-1636 Case of 12, Ready to use 8 Oz. Bottles
- 10-1635 Case of 4, 1 Gallon, Concentrated



SKLAR DISINFECTANT

Liquid

- 10-1643 Case of 6, 24 Oz. Spray Bottles
- 10-2762 Case of 12, 24 Oz. Spray Bottles
- 10-2760 Case of 12, 8 Oz. Spray Bottles



SKLAR DISINFECTANT

Liquid

- 10-1653 Case of 4, 1 Gallon
- 10-2763 5 Gallon Container



SKLAR POLISH

- 10-1626 Case of 12, 8 Oz. Jars
- 10-1629 Case of 6, 8 Oz. Jars



SKLAR ANTI-MICROBIAL

Soap

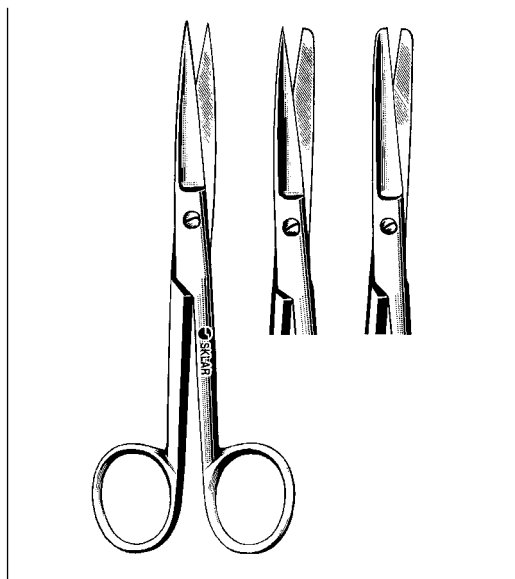
- 10-1618 Case of 12, 16 Oz. Pumps
- 10-1619 1 Gallon Refill
- 10-1620 32 Oz. Refill



SKLAR CREAM

Professional Skin Lotion

- 10-1622 Case of 12, 16 Oz. Pumps



OPERATING SCISSORS

Straight

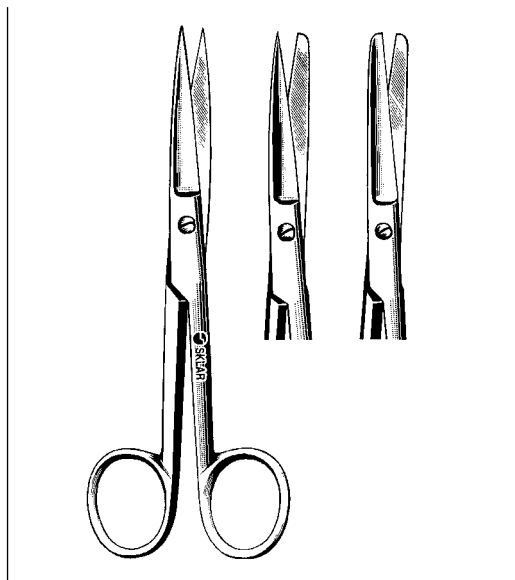
S/S	S/B	B/B
13-1045	4½"	14-1045 4½"
13-1050	5"	14-1050 5"
13-1055	5½"	14-1055 5½"
13-1060	6"	14-1060 6"
13-1065	6½"	14-1065 6½"



SKLARLITE OPERATING SCISSORS

Straight

S/S	S/B
23-1100	4½"
23-1101	5"
23-1102	5½"
23-1104	4½"
23-1105	5"
23-1106	5½"



OPERATING SCISSORS DELICATE

Straight

S/S	S/B	B/B
22-1145	4½"	22-1245 4½"
22-1150	5"	22-1250 5"
22-1155	5½"	22-1255 5½"
		22-1350 5"



SKLARLITE EXTRA DELICATE OPERATING SCISSORS

Straight

S/S	S/B
23-1112	4½"
23-1113	5"
23-1114	5½"
23-1116	4½"
23-1118	5½"



OPERATING SCISSORS

Curved

S/S	S/B	B/B
13-2045 4½"	14-2045 4½"	15-2045 4½"
13-2050 5"	14-2050 5"	15-2050 5"
13-2055 5½"	14-2055 5½"	15-2055 5½"
13-2060 6"	14-2060 6"	15-2060 6"
13-2065 6½"	14-2065 6½"	15-2065 6½"



SKLARLITE OPERATING SCISSORS

Curved

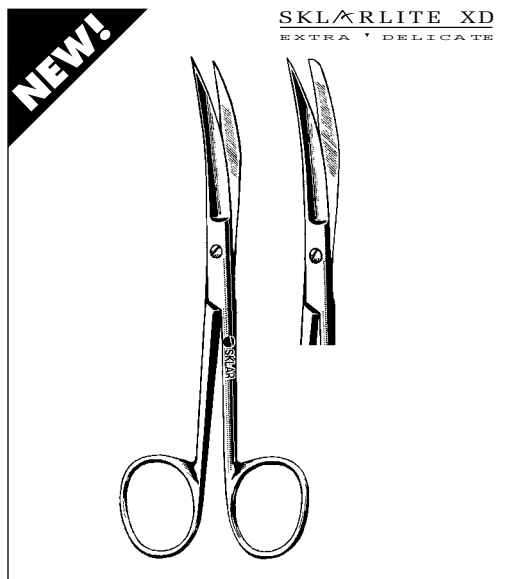
S/S	S/B
23-1124 4½"	23-1130 5½"
23-1126 5½"	



OPERATING SCISSORS DELICATE

Curved

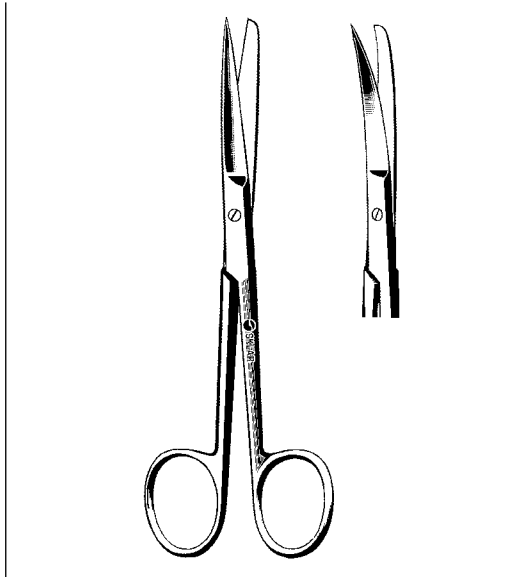
S/S	S/B	B/B
22-1445 4½"	22-1550 5"	22-1650 5"
22-1450 5"		
22-1455 5½"		



SKLARLITE EXTRA DELICATE OPERATING SCISSORS

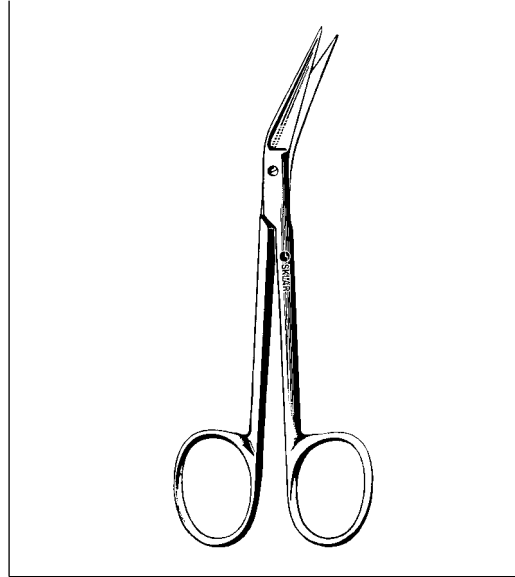
Curved

S/S	S/B
23-1138 5½"	23-1140 4½"
	23-1142 5½"



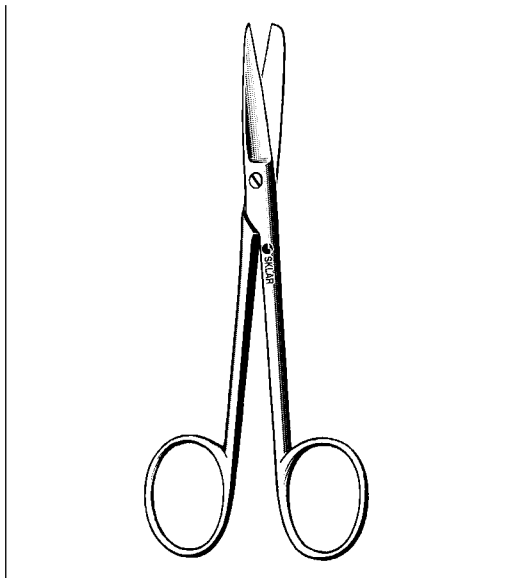
DEAVER SCISSORS DELICATE

Straight			Curved		
13-1155	S/S	5½"	13-2155	S/S	5½"
14-1155	S/B	5½"	14-2155	S/B	5½"
15-1155	B/B	5½"			



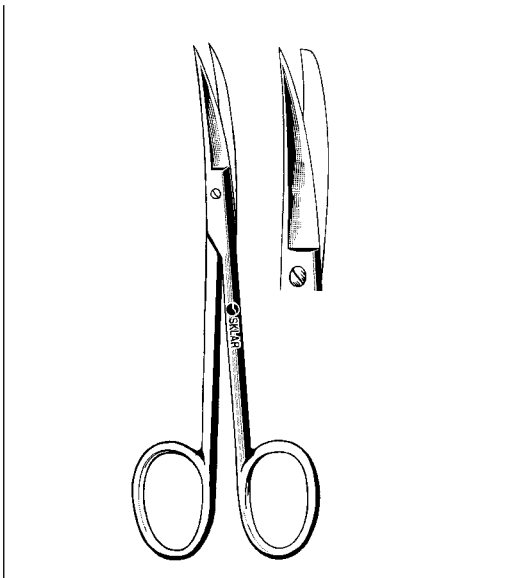
SKLAR ANGULAR SCISSORS

47-1080	S/S	4¾"	Smooth
47-1081	S/S	4¾"	Serrated



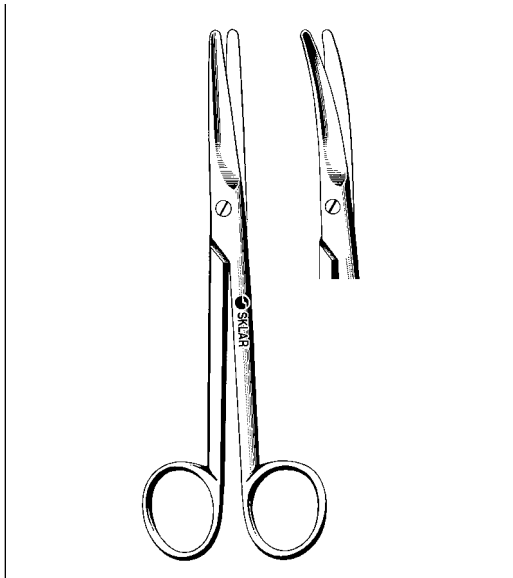
WAGNER SCISSORS STRAIGHT

Smooth		Serrated	
47-1047	S/S	4¾"	47-1049 S/S 4¾"
47-1048	S/B	4¾"	



WAGNER SCISSORS CURVED

Smooth		Serrated	
47-1058	S/S	4¾"	47-1059 S/S 4¾"
47-1068	S/B	4¾"	47-1069 S/B 4¾"



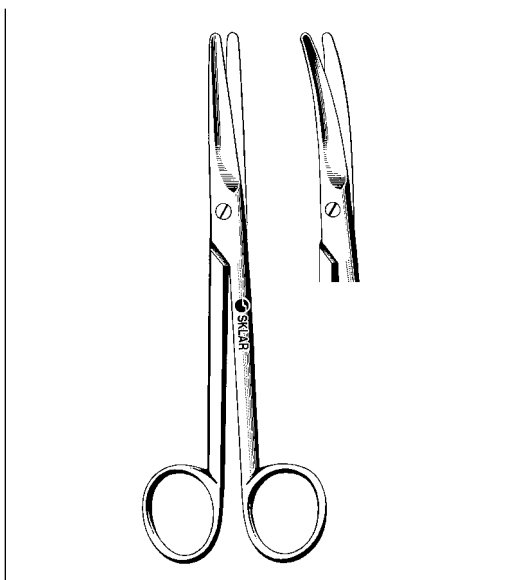
MAYO DISSECTING SCISSORS

Straight		Curved	
15-1555	5½"	15-2555	5½"
15-1567	6¾"	15-2567	6¾"
90-1590	9"	90-1690	9"
55-8711	11"	55-8611	11"



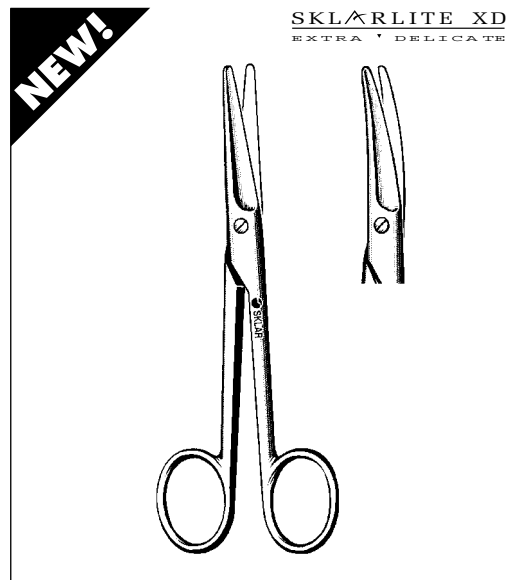
SKLARLITE MAYO DISSECTING SCISSORS

Straight		Curved	
23-1164	5½"	23-1166	5½"
23-1165	6¾"	23-1167	6¾"



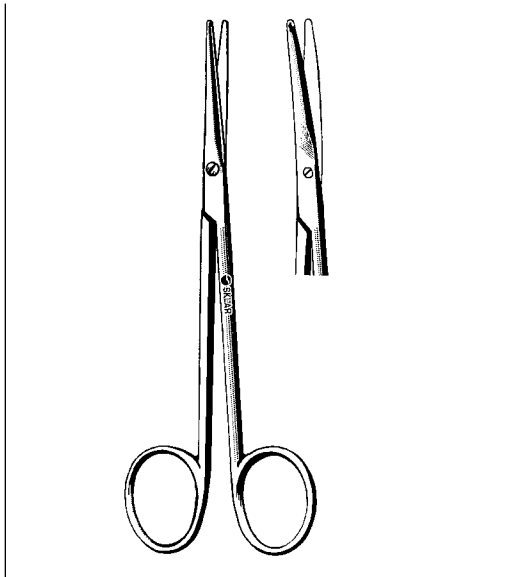
MAYO DISSECTING SCISSORS DELICATE

Straight		Curved	
22-1556	5½"	22-2555	5½"
22-1567	6¾"	22-2567	6¾"



SKLARLITE EXTRA DELICATE MAYO DISSECTING SCISSORS

Straight		Curved	
23-1168	5½"	23-1170	5½"
23-1169	6¾"	23-1171	6¾"



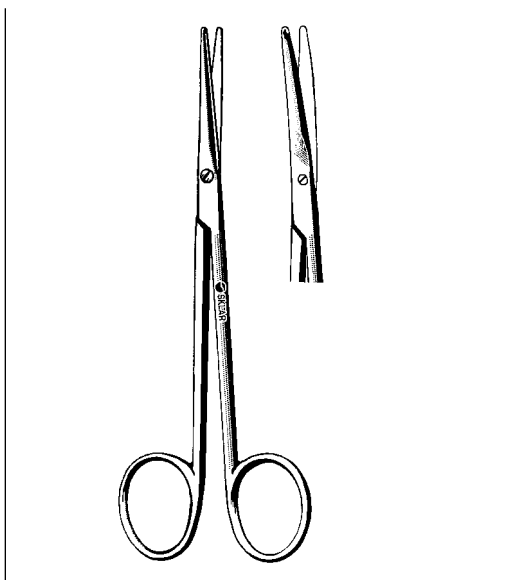
METZENBAUM (LAHEY) SCISSORS

Straight		Curved	
22-2550	4 ³ / ₄ "	22-2545	4 ³ / ₄ "
75-5460	5 ³ / ₄ "	47-1360	5 ³ / ₄ "



SKLARLITE METZENBAUM (LAHEY) SCISSORS

Straight		Curved	
23-1172	4 ³ / ₄ "	23-1174	4 ³ / ₄ "
23-1173	5 ³ / ₄ "	23-1175	5 ³ / ₄ "



METZENBAUM (LAHEY) SCISSORS DELICATE

Straight		Curved	
22-2450	4 ³ / ₄ "	22-2650	4 ³ / ₄ "
22-2460	5 ³ / ₄ "	22-1057	5 ³ / ₄ "



SKLARLITE EXTRA DELICATE METZENBAUM (LAHEY) SCISSORS

Straight		Curved	
23-1176	4 ³ / ₄ "	23-1178	4 ³ / ₄ "
23-1177	5 ³ / ₄ "	23-1179	5 ³ / ₄ "



METZENBAUM DISSECTING SCISSORS

Straight		Curved	
75-5570	7"	75-5670	7"
55-9180	8" (Nelson)	55-9080	8" (Nelson)
55-9190	9" (Nelson)	55-9090	9" (Nelson)
55-9310	10" (Nelson)	55-9210	10" (Nelson)
55-9311	11" (Nelson)	55-9411	11" (Nelson)
		55-9612	12" (Nelson)
		55-9614	14" (Nelson)



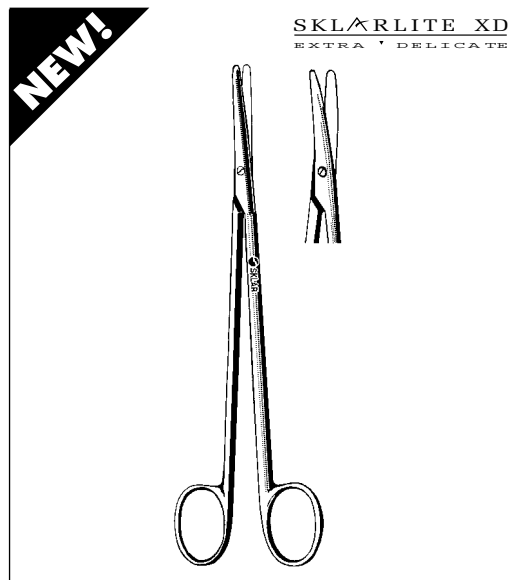
SKLARLITE METZENBAUM DISSECTING SCISSORS

Straight		Curved	
23-1180	7"	23-1182	7"



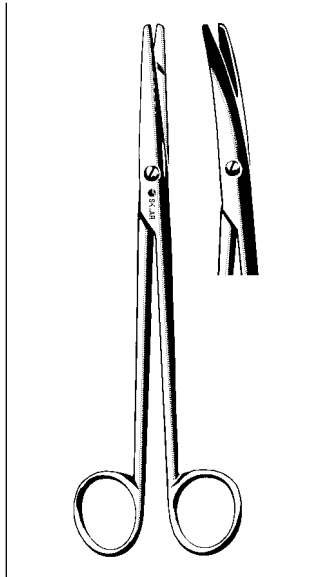
METZENBAUM DISSECTING SCISSORS DELICATE

Straight		Curved	
22-1071	7"	22-1070	7"
55-9184	8" (Nelson)	55-9084	8" (Nelson)
55-9194	9" (Nelson)	55-9094	9" (Nelson)



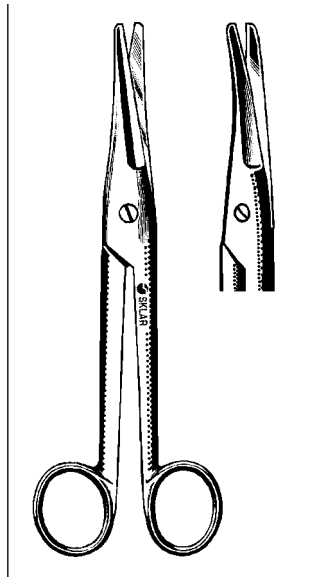
SKLARLITE EXTRA DELICATE METZENBAUM DISSECTING SCISSORS

Straight		Curved	
23-1184	7"	23-1186	7"



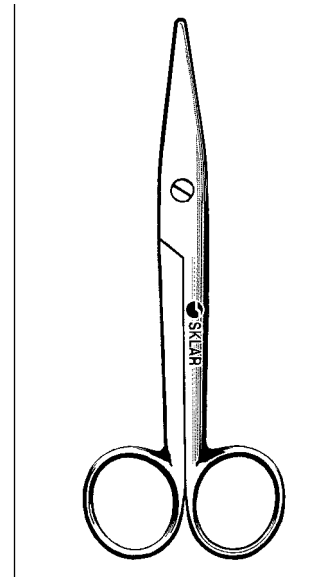
**MAYO-STILLE
DISSECTING SCISSORS
ROUNDED BLADES**

Straight		Curved	
15-1655	5½"	15-2655	5½"
15-1667	6¾"	15-2667	6¾"



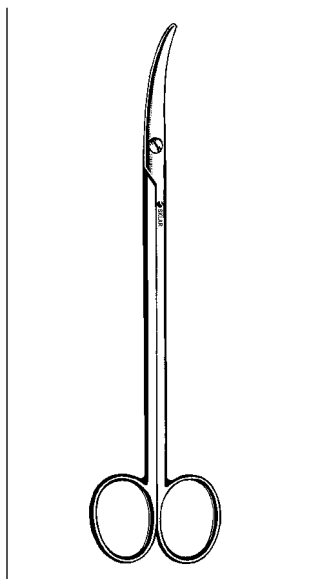
**MAYO-NOBLE
DISSECTING SCISSORS**

Beveled Blade		Curved	
Straight		Curved	
15-1762	6½"	15-2762	6½"



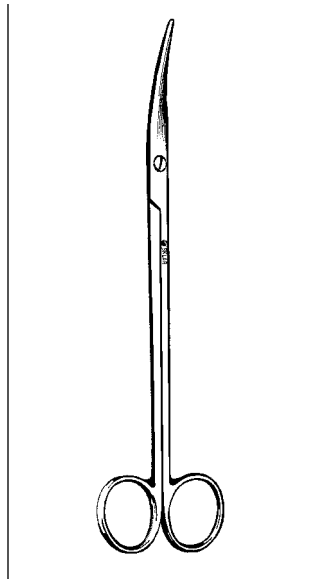
**MAYO-NOBLE-STILLE
DISSECTING SCISSORS**

Straight		Curved	
15-1862	6½"	15-2862	6½"



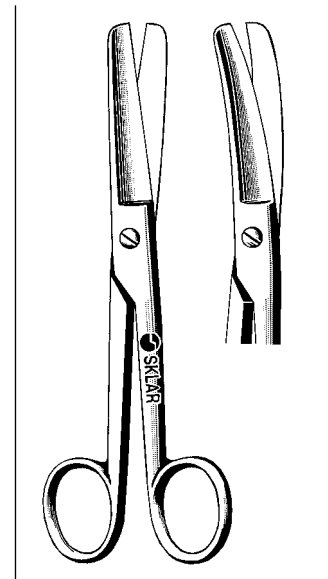
**ESSRIG
DISSECTING SCISSORS**

Curved		
15-2460	6"	Delicate
15-2470	7"	Delicate



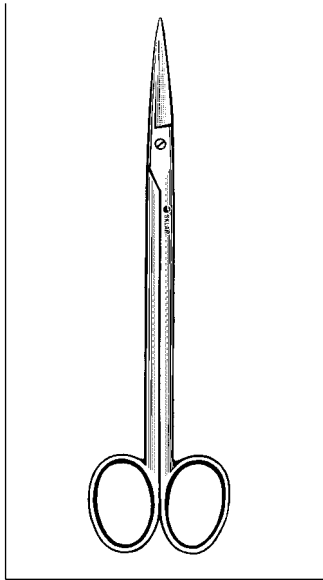
**ADA
DISSECTING SCISSORS**

Curved		
52-3160	6"	
52-3170	7"	



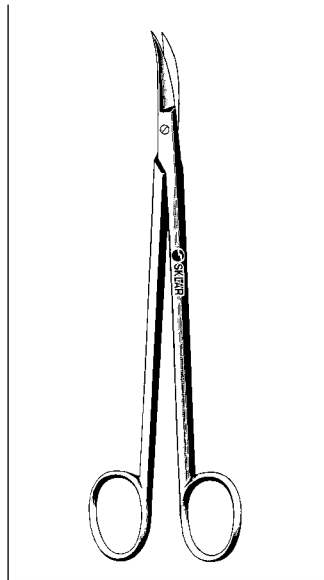
DOYEN SCISSORS

Straight		Curved	
15-1307	7" Smooth	15-2307	7" Smooth
15-1308	7" Serr	15-2308	7" Serr



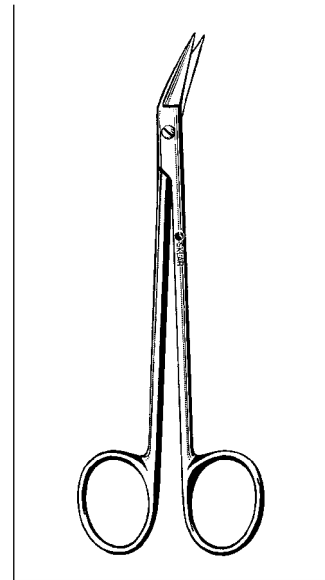
KELLY-ADSON SCISSORS

50-4562 6¼" Smooth/Straight
 50-4563 6¼" Serrated/Straight



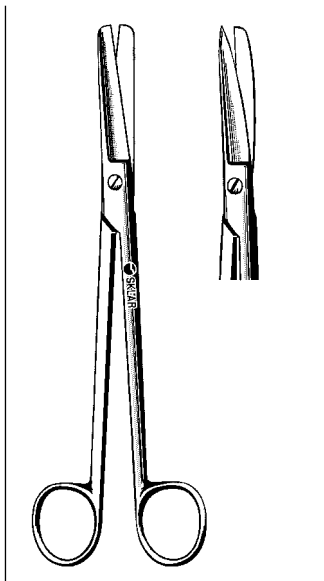
KELLY-ADSON SCISSORS

Curved
 50-4662 6¼" Smooth



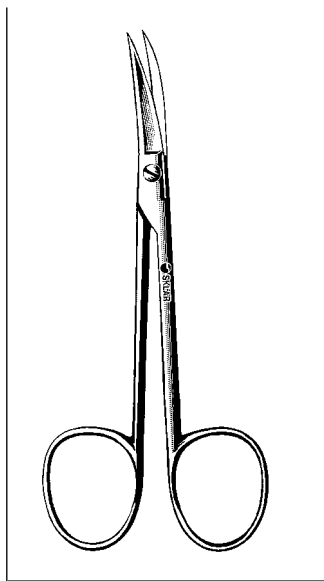
KELLY-ADSON SCISSORS

Angular
 50-4462 6¼" Smooth



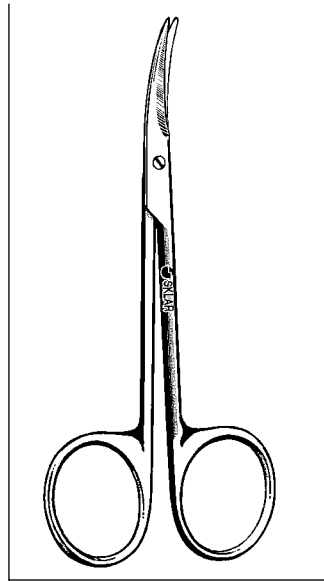
SIMS SCISSORS

Straight	Curved
90-1280 8" S/S	90-1580 8" S/S
90-1180 8" S/B	90-1480 8" S/B
90-1080 8" B/B	90-1380 8" B/B



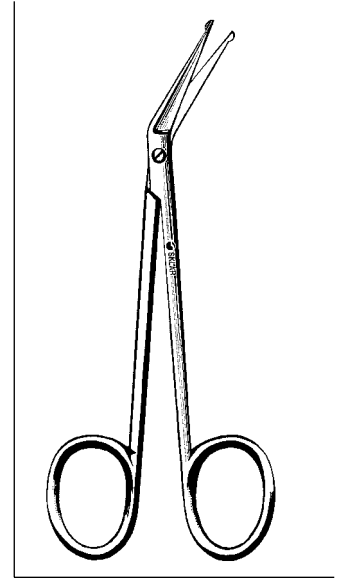
PLASTIC SURGERY SCISSORS

Curved
 47-1345 4½" S/S



DURA SCISSORS SEMI-SHARP

Curved
 22-2742 4¼"



ANGULAR IRIS SCISSORS PROBE POINT

64-2042 4¼"

Skларlite™ Scissors Offer The Surgeon Exquisite Control

Skлар has developed a new line of premium operating room scissors that offers the surgeon maximum control and precision. Our research determined a need for scissors of a lighter pattern while retaining the strength and durability of a standard pattern.

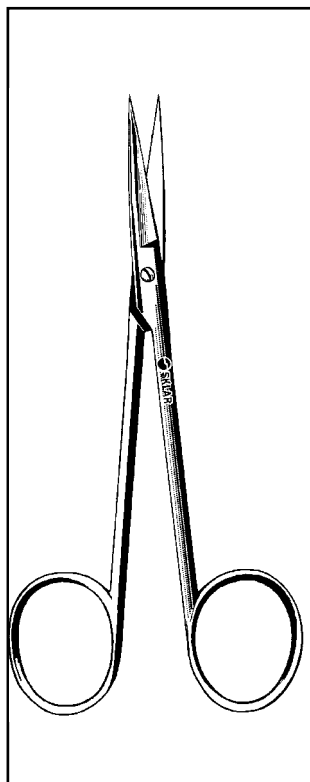
Skлар has recognized the need for a manufacturing technique that mills scant microns off our standard pattern while maintaining the structural integrity of the original instrument. The result is a noticeably lighter, extremely sensitive instrument that can withstand the daily rigors of surgery.

SKLARLITE™ scissors carry the same day-in and day-out reliability that you have come to expect from all Skлар instruments. Skлар has applied its more than 100 years of experience in developing this superior instrument.

SKLARLITE™ scissors are covered under the same warranty that guarantees all Skлар instruments for a lifetime of dependable use.



Skлар Exclusive!



IRIS SCISSORS

Straight

47-1135 S/S 3½"

47-1145 S/S 4½"

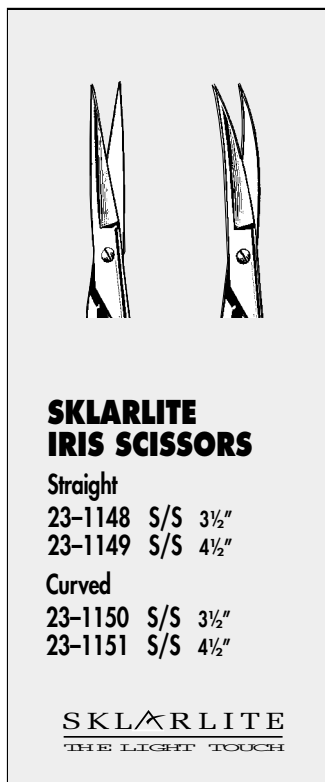
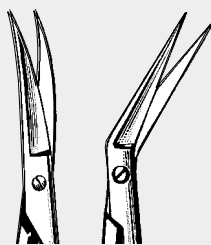
Curved

47-1235 S/S 3½"

47-1245 S/S 4½"

Angular

64-2142 S/S 4½"



SKLARLITE IRIS SCISSORS

Straight

23-1148 S/S 3½"

23-1149 S/S 4½"

Curved

23-1150 S/S 3½"

23-1151 S/S 4½"

SKLARLITE
THE LIGHT TOUCH

Skarlite XD™ Scissors Deliver The Ultimate In Precision

Sklar has surpassed industry standards by developing a delicate pattern operating room scissors that offers the surgeon one of the lightest general surgery scissors on the market today. For the surgeon who demands the finest in OR scissors, *Sklar is the choice.*

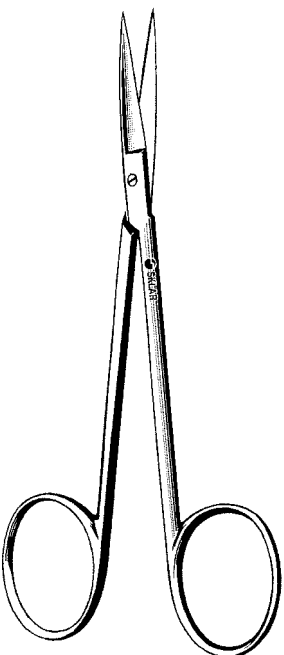
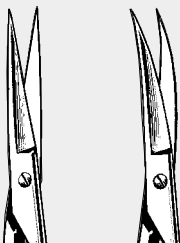
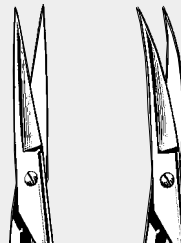
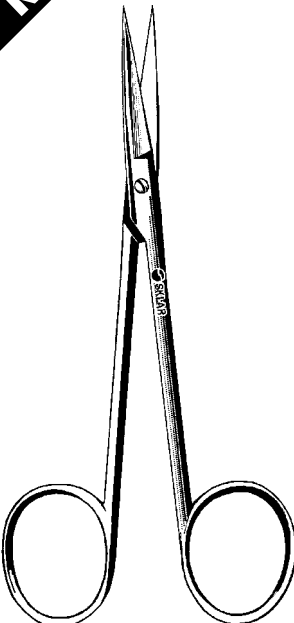
Sklar employs the same manufacturing process used in making the SKLARLITE™ scissors and mills scant microns off our delicate pattern while maintaining its structural integrity. The result is one of the most delicate and sensitive scissors available today.

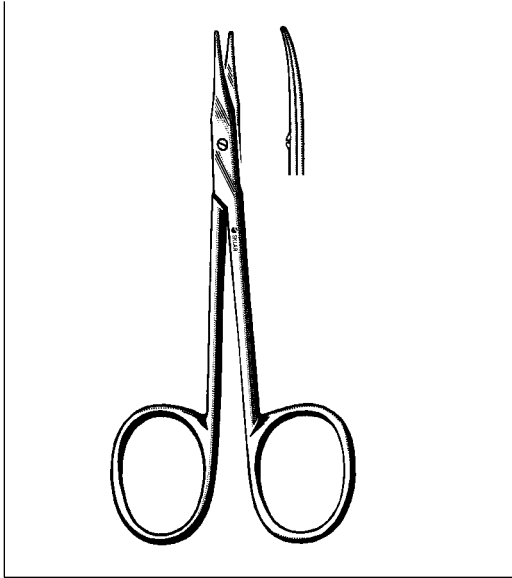
SKLARLITE XD™ scissors carry the same day-in and day-out reliability that you have come to expect from all Sklar instruments. Sklar has applied its more than 100 years of experience in developing this superior instrument.

SKLARLITE XD™ scissors are covered under the same warranty that guarantees all Sklar instruments for a lifetime of dependable use.



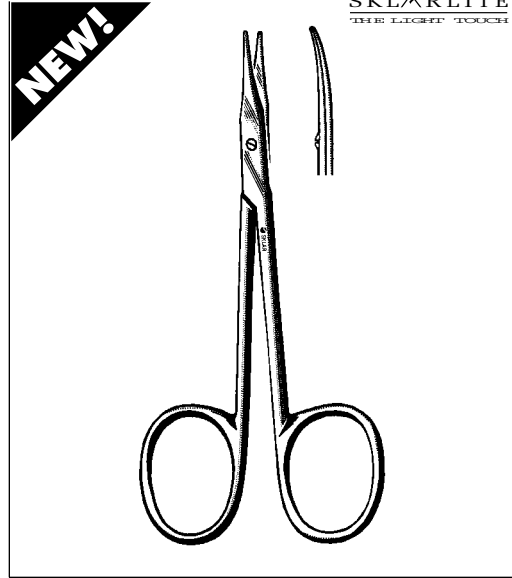
Sklar Exclusive!

	 <p>IRIS SCISSORS DELICATE</p> <p>Straight 22-1135 S/S 3½" 47-1246 S/S 4¼"</p> <p>Curved 22-1235 S/S 3½" 47-1248 S/S 4¼"</p>	 <p>SKLARLITE EXTRA DELICATE IRIS SCISSORS</p> <p>Straight 23-1152 S/S 3½" 23-1153 S/S 4¼"</p> <p>Curved 23-1154 S/S 3½" 23-1155 S/S 4¼"</p> <p>SKLARLITE XD EXTRA ▼ DELICATE</p>	<p>NEW!</p> 
---	--	--	--



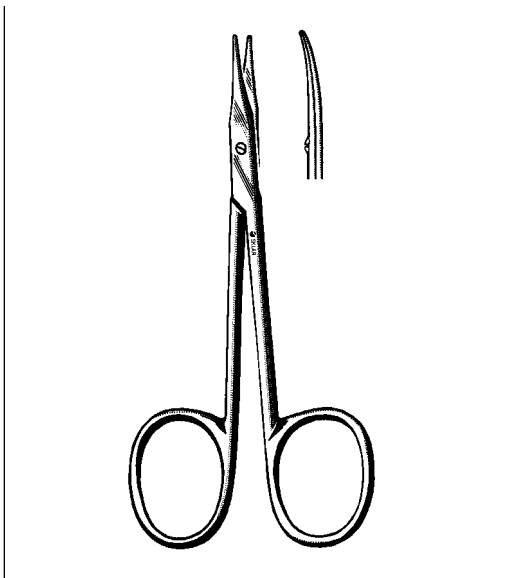
**STEVENS TENOTOMY
SCISSORS**

Straight	Curved
64-1242 4¼" B/B	64-1342 4¼" B/B



**SKLARLITE STEVENS
TENOTOMY SCISSORS**

Straight	Curved
23-1156 4¼" B/B	23-1157 4¼" B/B



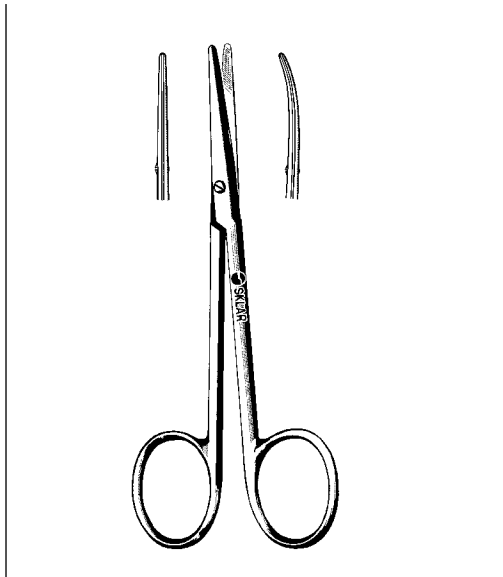
**STEVENS TENOTOMY
SCISSORS DELICATE**

Straight	Curved
22-1242 4¼" B/B	22-1342 4¼" B/B
22-1240 4¼" S/S	22-1241 4¼" S/S



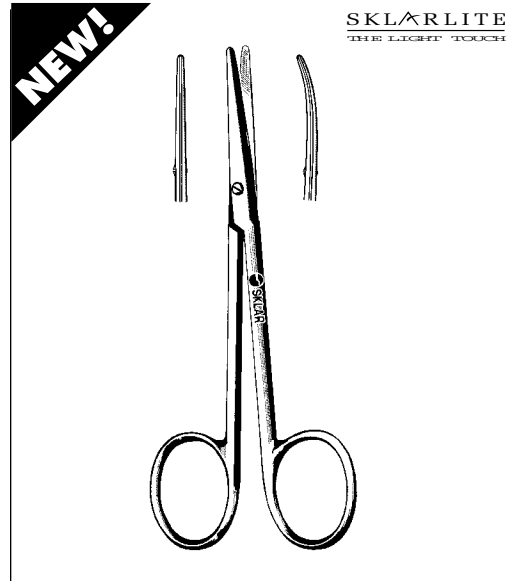
**SKLARLITE EXTRA DELICATE
STEVENS TENOTOMY SCISSORS**

Straight	Curved
23-1160 4¼" B/B	23-1161 4¼" B/B



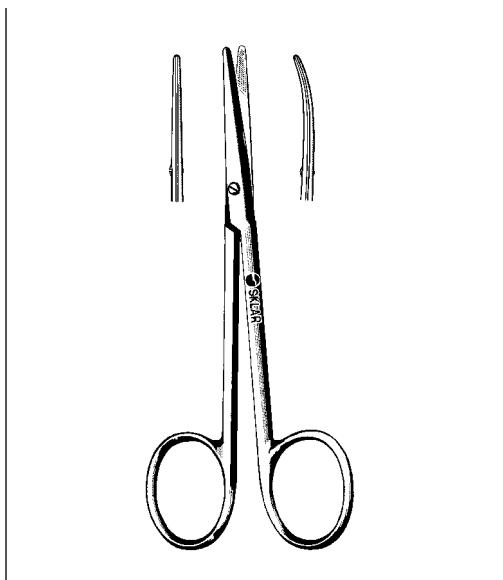
STRABISMUS SCISSORS

Straight	Curved
64-1442 4 1/4"	64-1542 4 1/4"



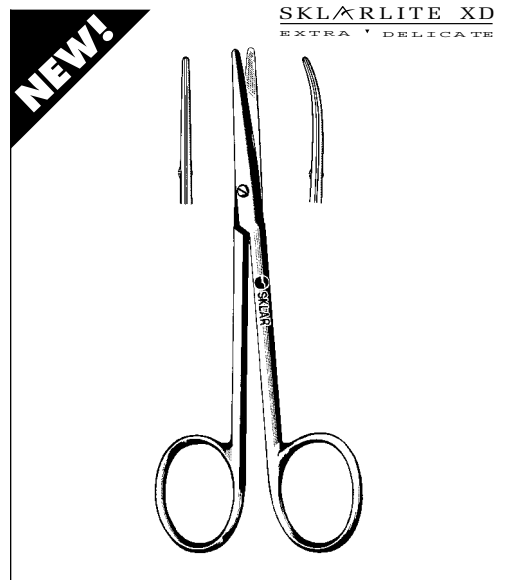
SKLARLITE STRABISMUS SCISSORS

Straight	Curved
23-1158 4 1/4"	23-1159 4 1/4"



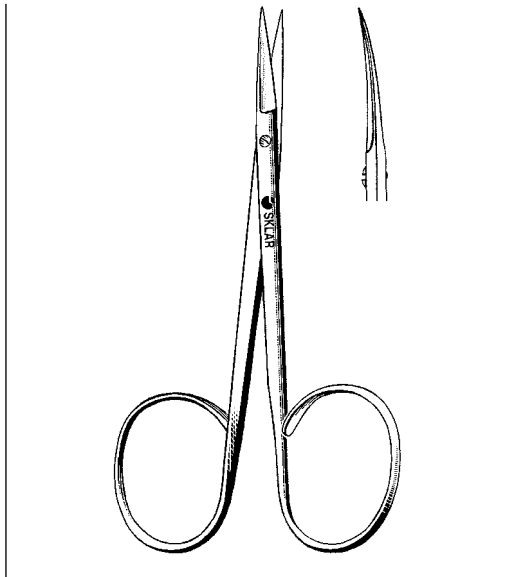
STRABISMUS SCISSORS DELICATE

Straight	Curved
22-1442 4 1/4"	22-1542 4 1/4"



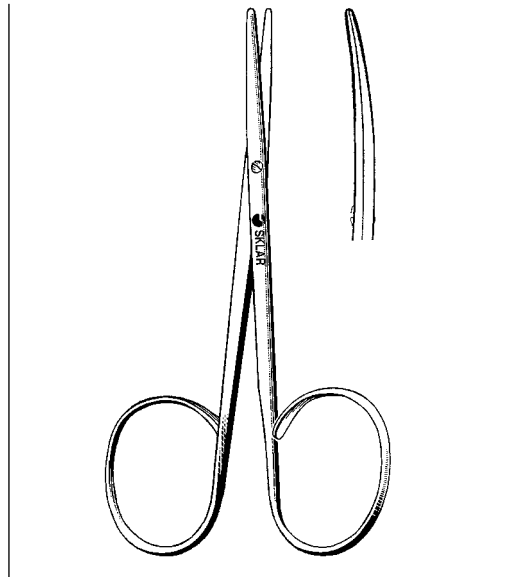
SKLARLITE EXTRA DELICATE STRABISMUS SCISSORS

Straight	Curved
23-1162 4 1/4"	23-1163 4 1/4"



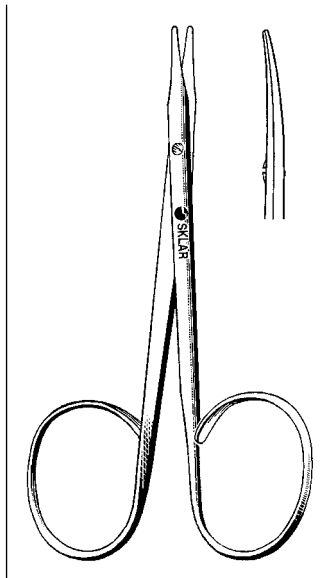
RIBBON IRIS SCISSORS

Straight 47-1250 4" Curved 47-1255 4"



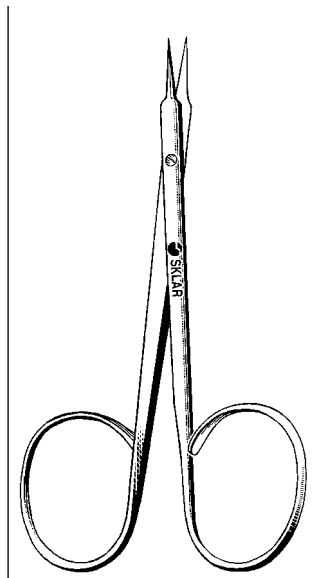
RIBBON STRABISMUS SCISSORS

Straight 64-1240 4½" Curved 64-1340 4½"



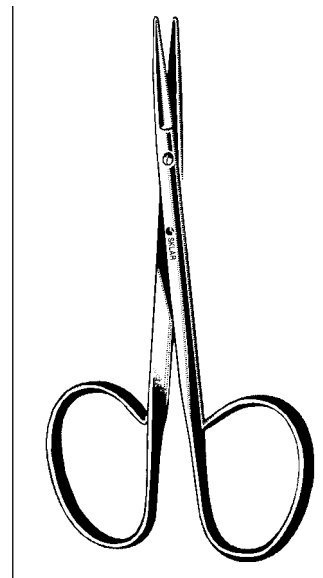
RIBBON STEVENS TENOTOMY SCISSORS

Straight 64-1241 4" Curved 64-1341 4"



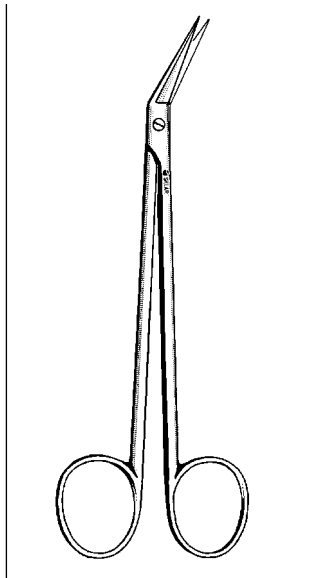
RIBBON STITCH SCISSORS

64-1345 4"



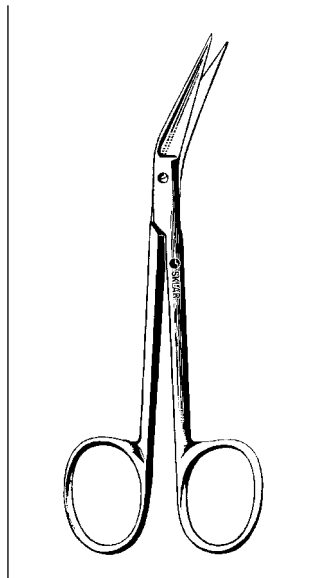
UTILITY SCISSORS

15 mm Blunt Tips
47-1146 4" Straight
47-1247 4" Curved



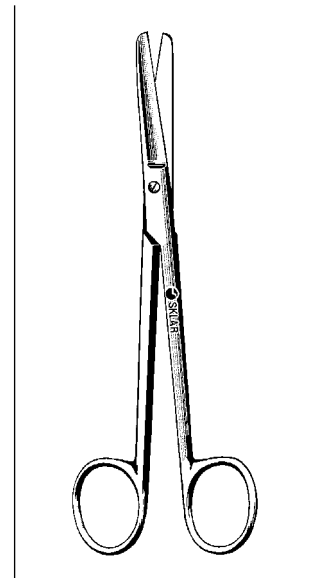
**SKLAR SKIN FLAP
SCISSORS**

41-1080 6½" Angled On Flat



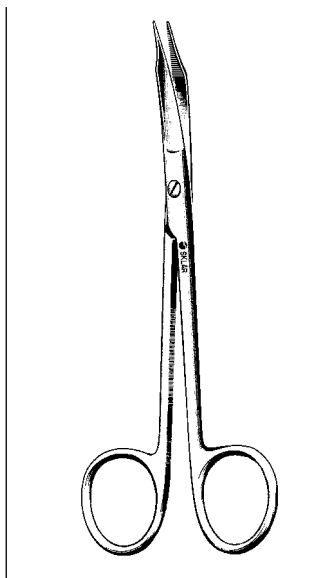
**SKLAR ANGULAR
SCISSORS**

47-1080 S/S 4¾" Smooth
47-1081 S/S 4¾" Serrated



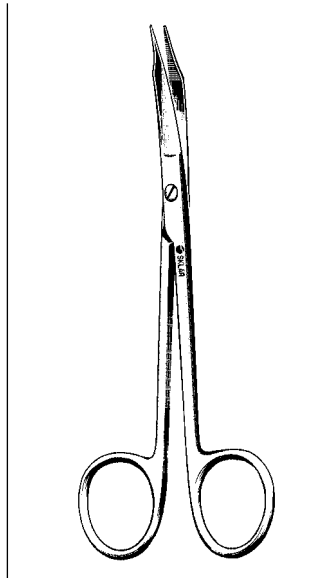
MIXTER SCISSORS

Straight
15-1360 6¼"



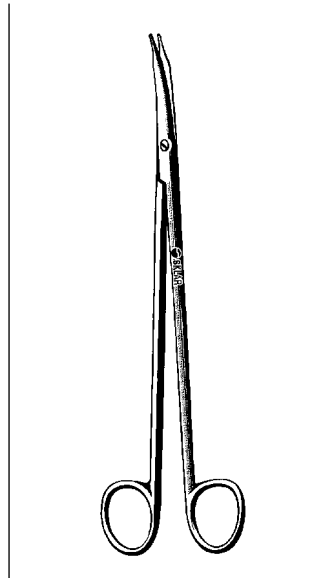
MARTIN SCISSORS

41-1120 7¾" Heavy Serrated



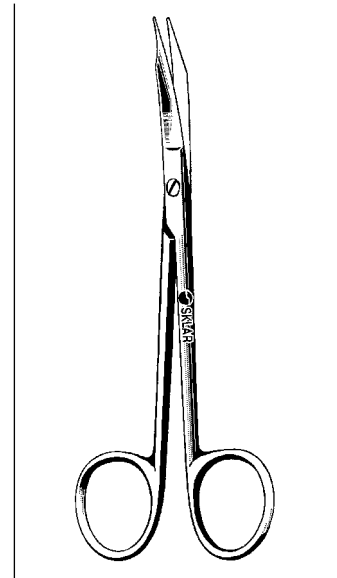
**MILLER DISSECTING
SCISSORS**

Back Edges Semi-Sharp
41-1125 5" Serrated



REYNOLDS SCISSORS

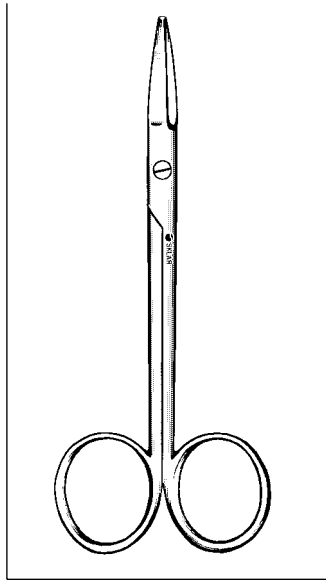
Narrow Tip, Curved
22-2760 6"



**GOLDMAN-FOX
SCISSORS**

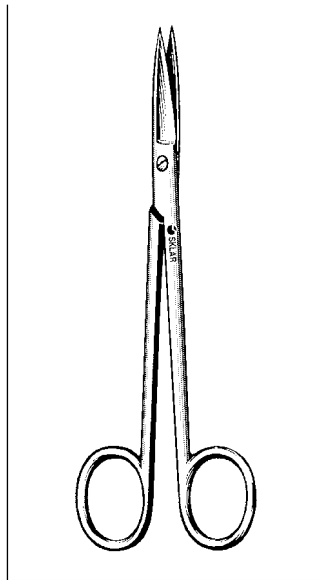
Curved
22-2520 5" Serrated

SCISSORS



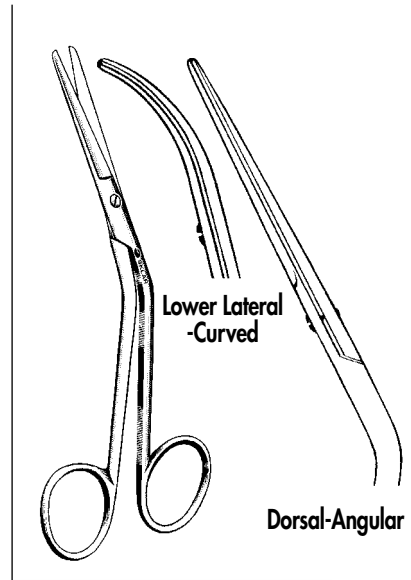
JOSEPH SCISSORS

Double Edge
41-1058 5 1/4" Straight



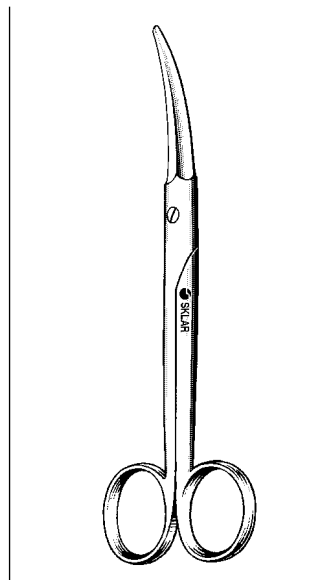
JOSEPH SCISSORS

41-1050 5 3/4" Straight



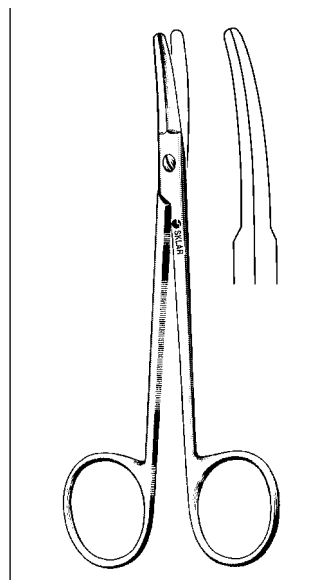
FOMON SCISSORS

70-4352 5 1/4" Lower Lateral-Curved
70-4350 5" Dorsal-Angular



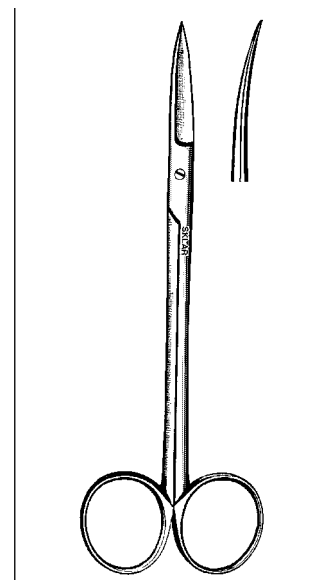
AUFRICHT FACE LIFT SCISSORS

Curved Triangular Blades
41-1167 5 3/4"



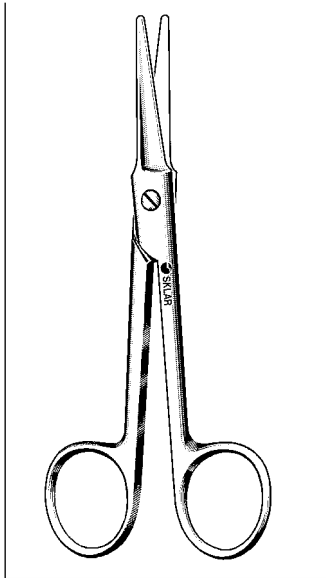
FOMON SABER BACK SCISSORS

Semi Sharp Back Edges
41-1076 5 1/2" Curved



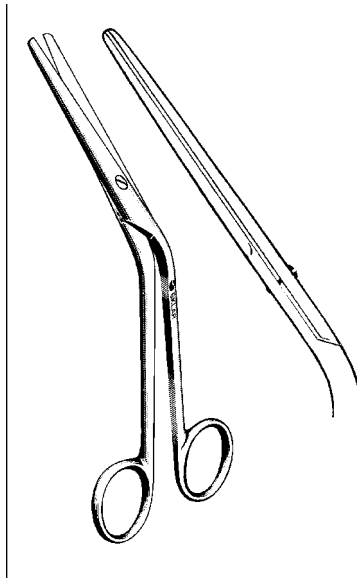
RHYTIDECTOMY SCISSORS

41-1100 6 1/2" Straight
41-1105 6 1/2" Curved



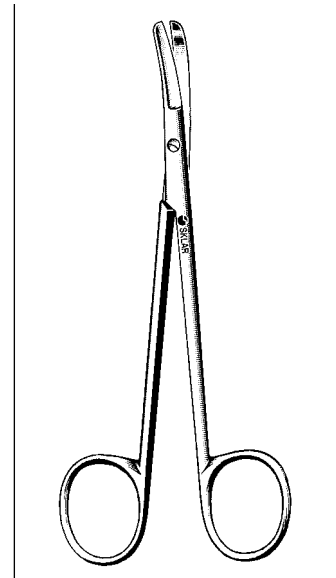
**BROWN DISSECTING
SCISSORS**

Heavy Pattern
41-1078 5½" Straight
41-1079 5½" Curved



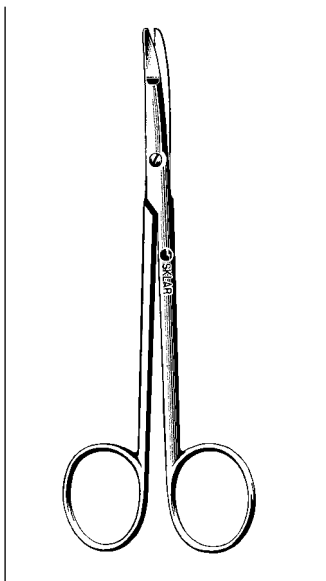
**COTTLE DORSAL
SCISSORS**

Heavy Rounded Blades
41-1169 6½" Angular



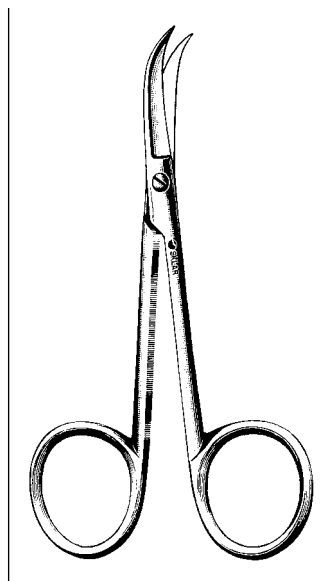
**COTTLE NASAL
SCISSORS**

Strong Short Blades
41-1168 4½" Curved



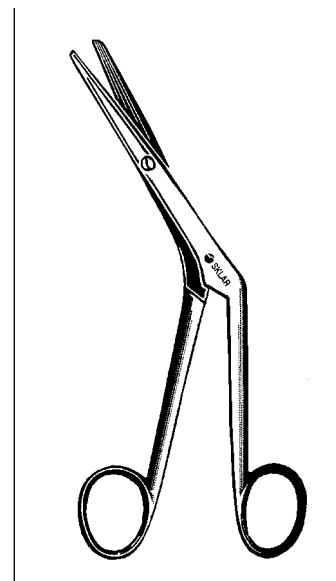
**RAGNELL DISSECTING
SCISSORS (FLAT TIPS)**

Curved
22-2652 5"



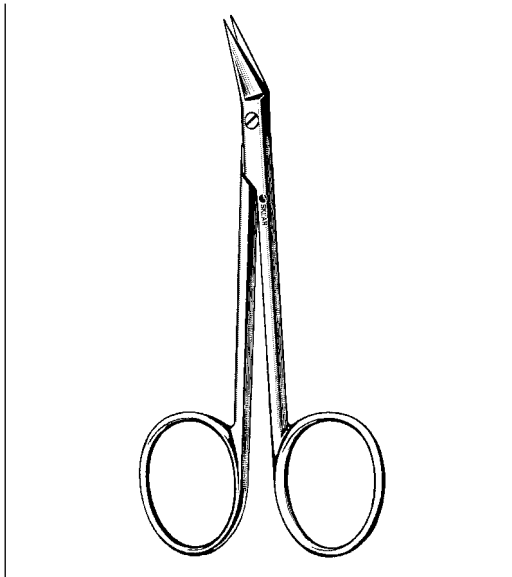
HILL SCISSORS

Sharp Points Curved Sideways
22-2955 4¾"



**KNIGHT NASAL
SCISSORS**

70-4262 6¼"



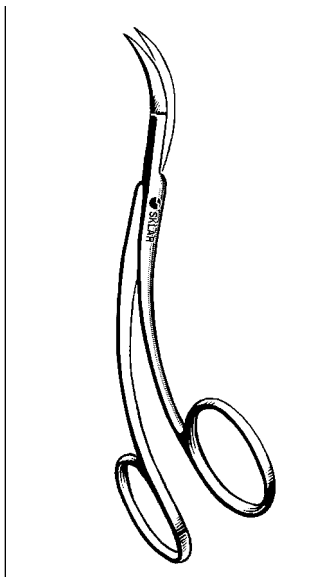
WILMER IRIS SCISSORS

Angled On Flat
64-1735 4"



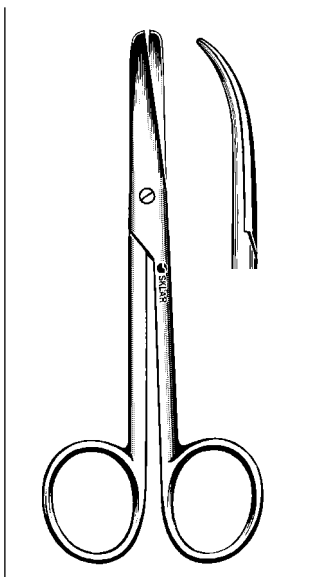
SISTRUNK SCISSORS

Straight Curved
15-2445 5½" 15-2455 5½"



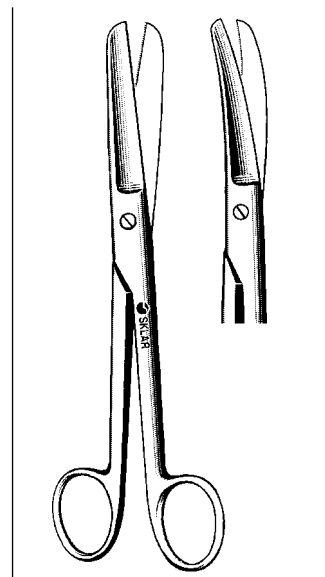
LA GRANGE SCISSORS

S-Shaped
22-2745 4½" S/S



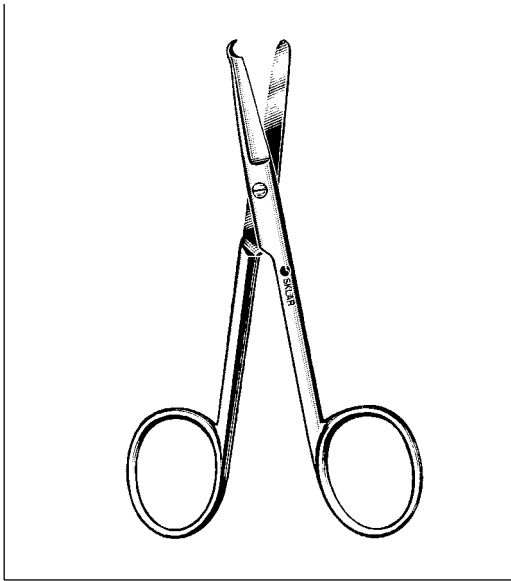
ENUCLEATION SCISSORS

64-1150 5" Curved



VET SCISSORS

Serrated
93-1065 6½" Straight
93-1165 6½" Curved



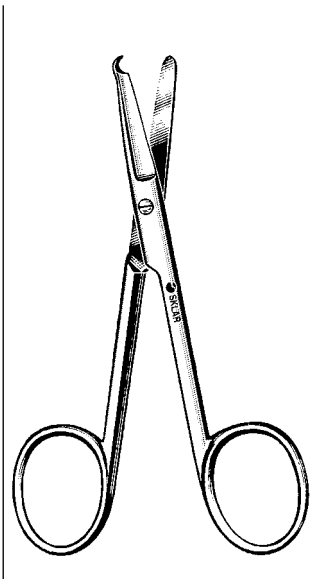
SPENCER STITCH SCISSORS

22-2835 3½"
 22-2845 4½"
 15-1355 5½" Littauer



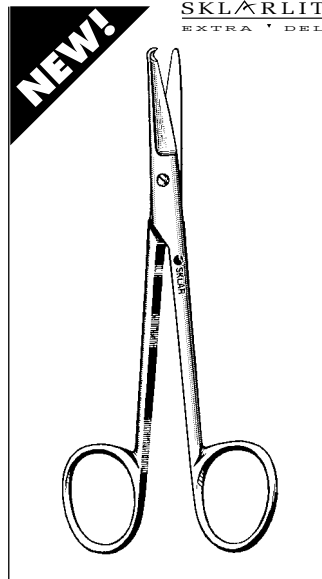
SKLARLITE SPENCER STITCH SCISSORS

23-1188 3½"
 23-1189 4½"
 23-1190 5½" Littauer



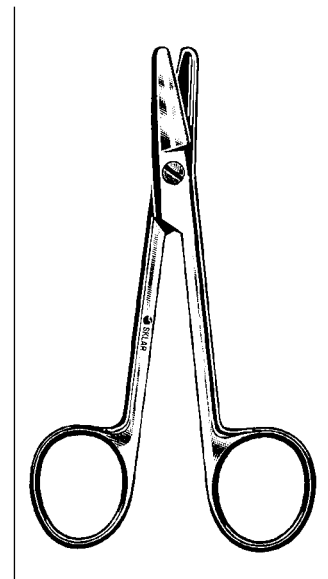
SPENCER STITCH SCISSORS DELICATE

22-2834 3½"
 22-2844 4½"
 22-1354 5½" Littauer



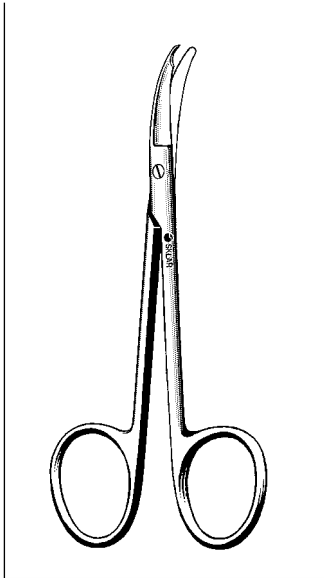
SKLARLITE EXTRA DELICATE SPENCER STITCH SCISSORS

23-1193 3½"
 23-1194 4½"
 23-1195 5½" Littauer



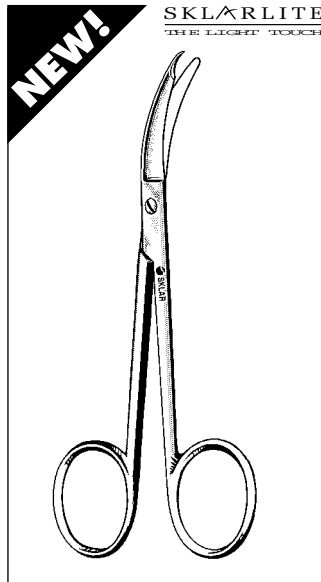
SUTURE WIRE CUTTING SCISSORS

24-2347 4¾" Straight, Serrated Edges



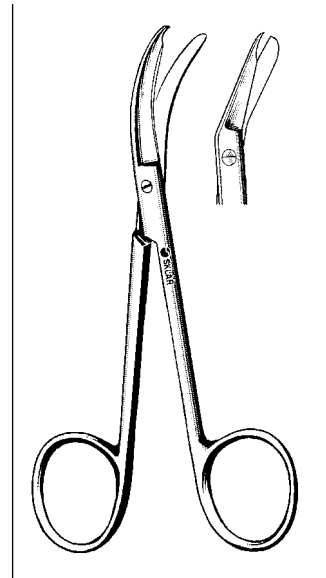
SUTURE SCISSORS

22-2935 3½" Shortbent
22-2947 4¾" Northbent



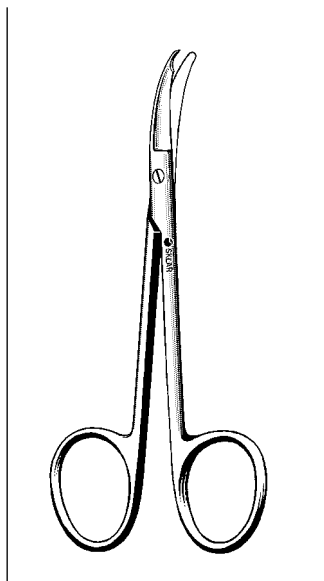
SKLARLITE SUTURE SCISSORS

23-1191 3½" Shortbent



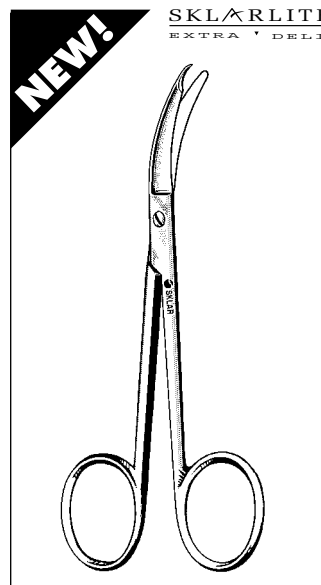
SKLAR STITCH SCISSORS

22-2950 5" Curved Sideways
15-3150 5" Angular



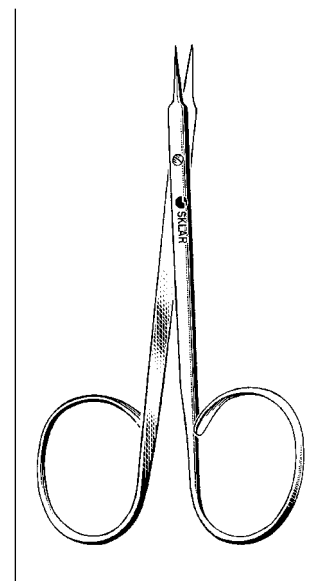
SUTURE SCISSORS DELICATE

22-2934 3½" Shortbent



SKLARLITE EXTRA DELICATE SUTURE SCISSORS

23-1196 3½" Shortbent



RIBBON STITCH SCISSORS

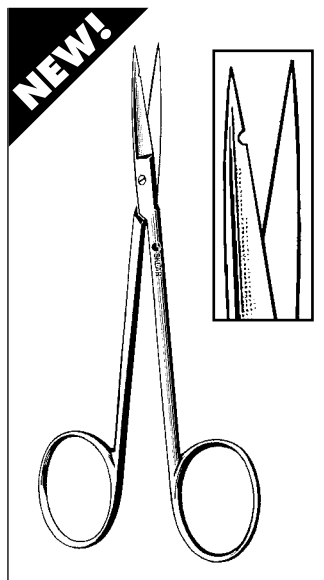
64-1345 4"

Sklar Combination Iris and Suture Scissors

These Special Scissors should be used for extremely delicate surgery, as the very popular Iris Scissors are used. The delicate blades are honed extremely fine and sharp. The upper blade has a fine serration to maintain grip and the lower blade is razor honed to give a smooth precision cut on tissue or suture. There is also a suture cutting notch near the tip of the blade.

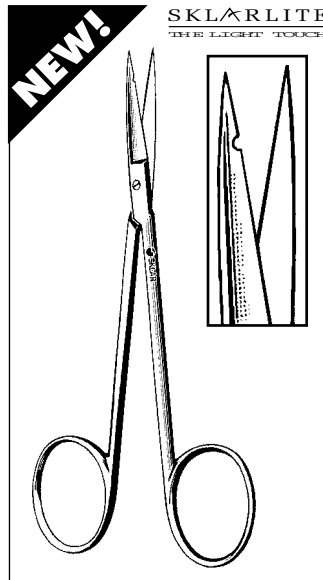
Sklar Exclusive!

Sklar Precision



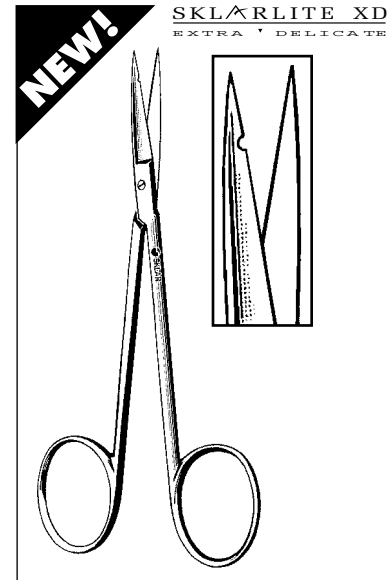
SKLAR PRECISION SCISSORS

22-2820	3½"	Straight
22-2822	3½"	Curved
22-2824	4½"	Straight
22-2825	4½"	Curved



SKLARLITE PRECISION SCISSORS

23-1290	3½"	Straight
23-1292	3½"	Curved
23-1294	4½"	Straight
23-1296	4½"	Curved



SKLARLITE XD PRECISION SCISSORS

23-1300	3½"	Straight
23-1302	3½"	Curved
23-1304	4½"	Straight
23-1306	4½"	Curved



LISTER BANDAGE SCISSORS

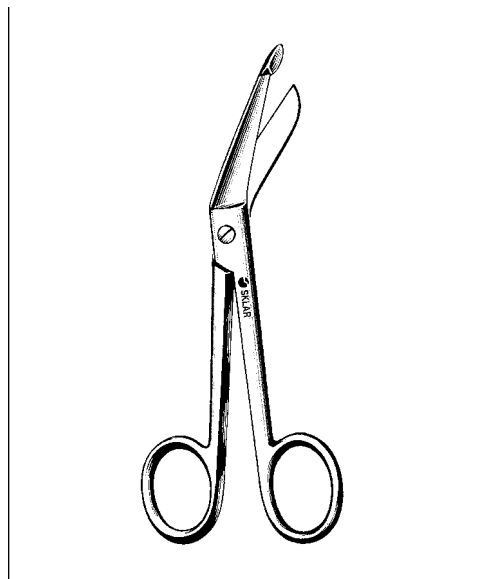
- 11-1035 3½"
- 11-1045 4½"
- 11-1055 5½"
- 11-1072 7¼"
- 11-1080 8"



SKLARLITE
THE LIGHT TOUCH

**SKLARLITE
LISTER BANDAGE SCISSORS**

- 23-1199 5½"
- 23-1200 7¼"



**LISTER BANDAGE SCISSORS
DELICATE**

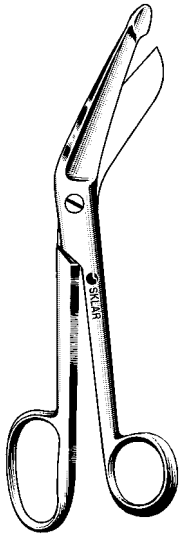
- 22-1054 5½"
- 22-1072 7¼"



SKLARLITE XD
EXTRA DELICATE

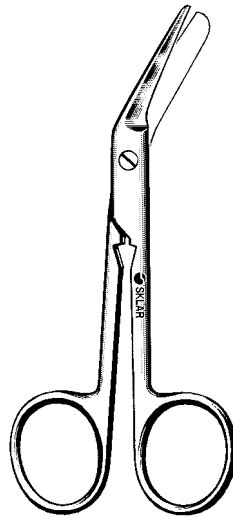
**SKLARLITE EXTRA DELICATE
LISTER BANDAGE SCISSORS**

- 23-1202 5½"
- 23-1203 7¼"



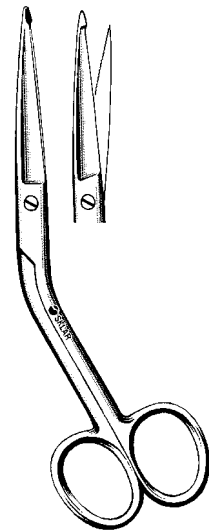
LISTER BANDAGE SCISSORS

Large Ring
11-1060 8"



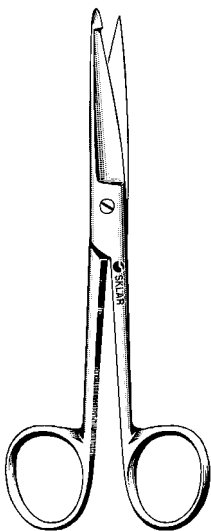
BURNHAM FINGER BANDAGE SCISSORS

11-1152 5¼"



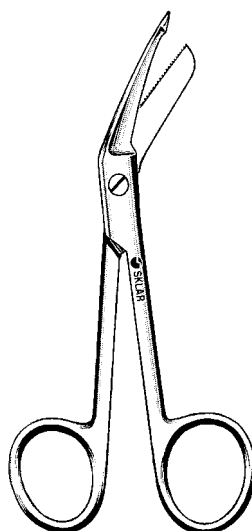
SKLAR HI LEVEL BANDAGE SCISSORS

Serrated
11-1252 5½"



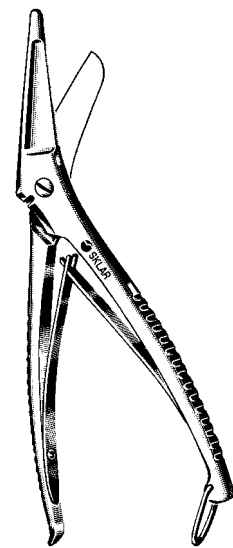
KNOWLES BANDAGE SCISSORS

11-1255 5½"



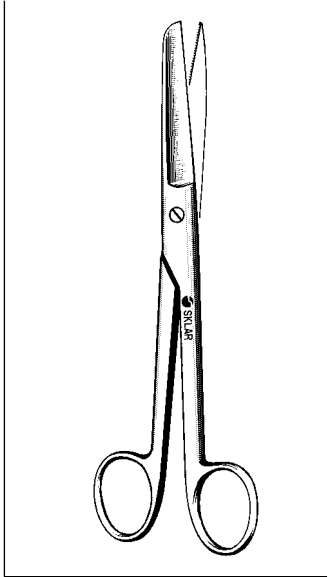
BANTAM BANDAGE SCISSORS

Serrated
11-1257 5¼"



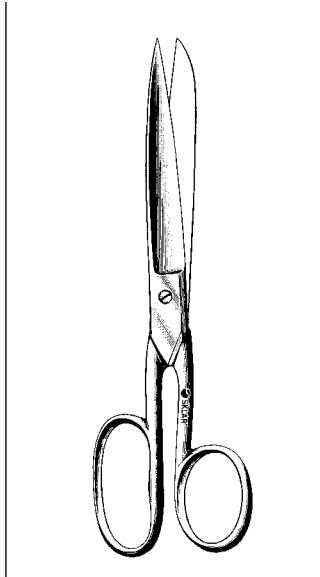
COMMANDER UTILITY SHEARS

Heavy Duty with Wire Cutting Notch
11-1298 8½"



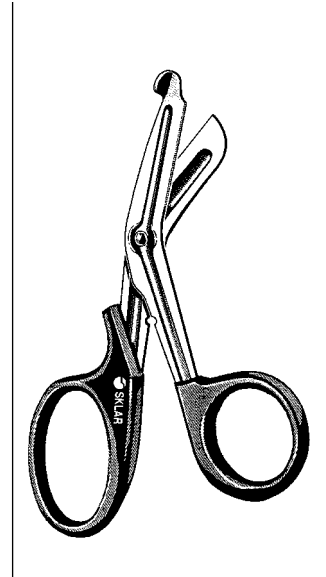
MOLESKIN AND FELT SCISSORS

Serrated
97-1350 7½" Straight
97-1351 7½" Curved



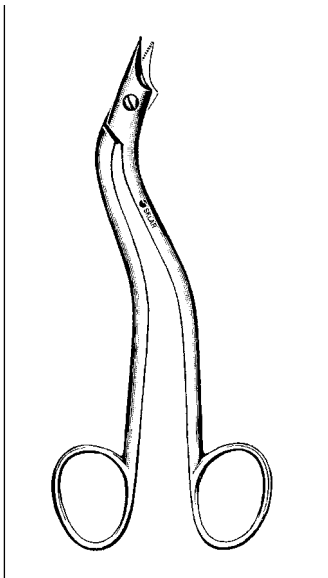
USA PATTERN GAUZE SCISSORS

11-1180 8"



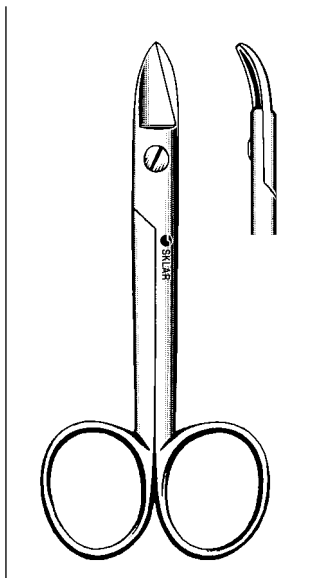
MULTI-CUT UTILITY SCISSORS

Serrated
11-1278 6"
11-1280 7½"



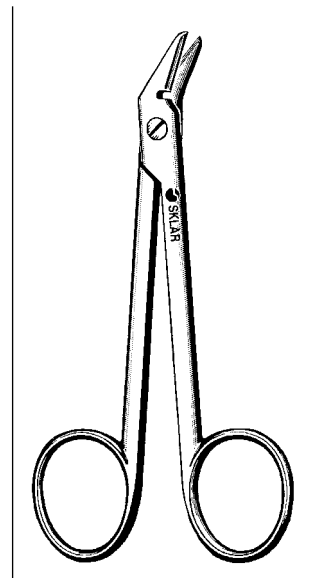
HEATH SCISSORS

24-1962 6¼" Serrated



CROWN & COLLAR CUTTING SCISSORS

Straight Curved
24-2345 4" 24-2346 4"
24-2340 4" Serr 24-2341 4" Serr

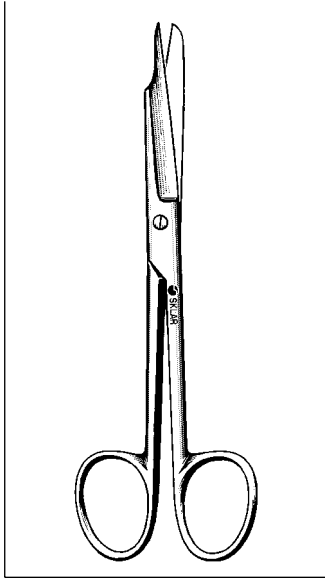


SUTURE WIRE CUTTING SCISSORS

Angular Serrated
24-2342 4¾"

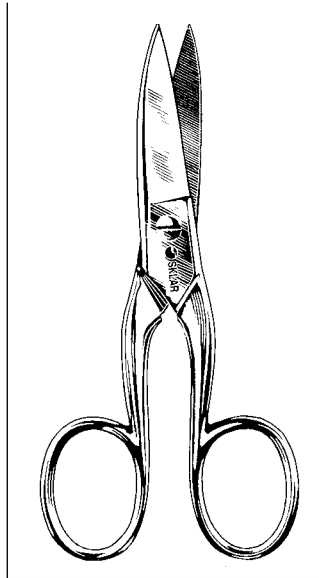
Tungsten Carbide
Angular Serrated
16-2800 4¾"

Sklar



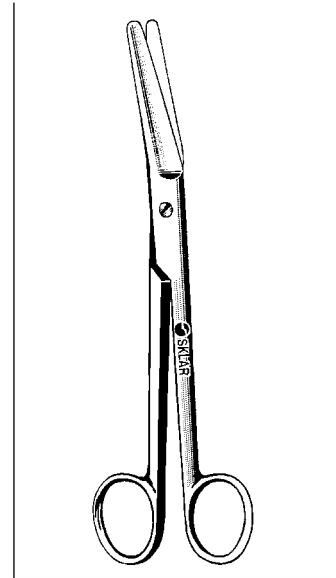
**INGROWN NAIL
SPLITTING SCISSORS**

One Pointed Blade
97-0555 6" Serrated



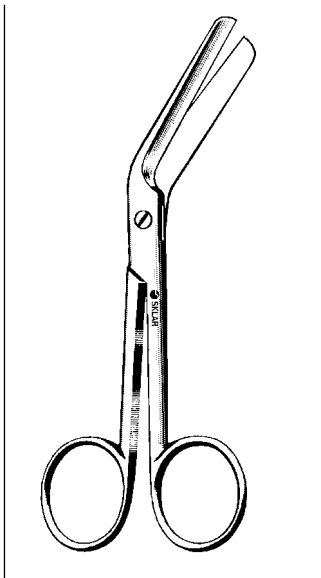
**CUTICLE AND NAIL
SCISSORS**

Ring Handle
97-1235 3½" Finger Nail
97-1245 4½" Toe Nail



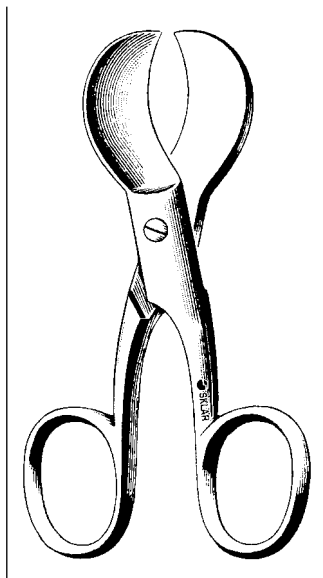
FERGUSON SCISSORS

15-3107 7"



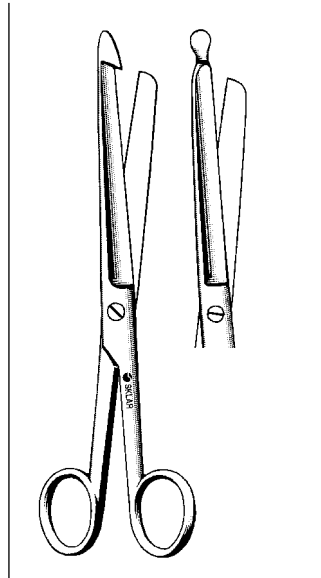
**BRAUN EPISIOTOMY
SCISSORS**

Angular, Guarded Blade
90-1755 5½"
90-1785 8½"



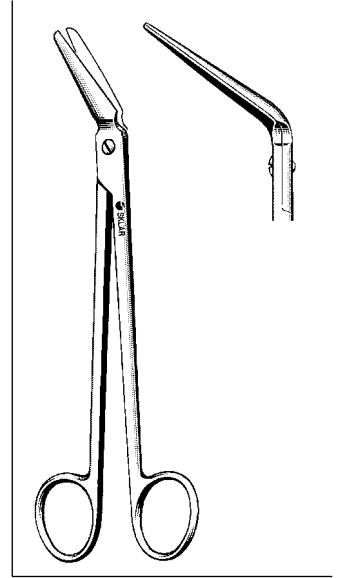
UMBILICAL SCISSORS

92-5540 4"



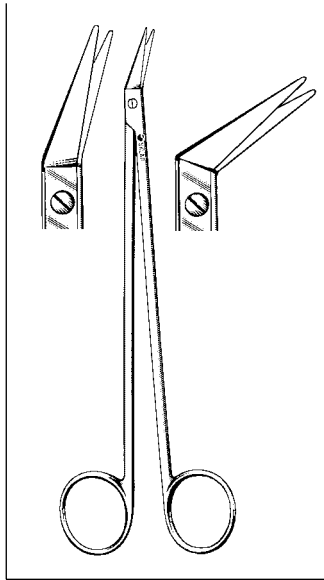
ENTEROTOME SCISSORS

Hook Point
15-1282 8¼"
Probe Point
15-1285 8¼"



**SWEET SCISSORS
45° ANGLE**

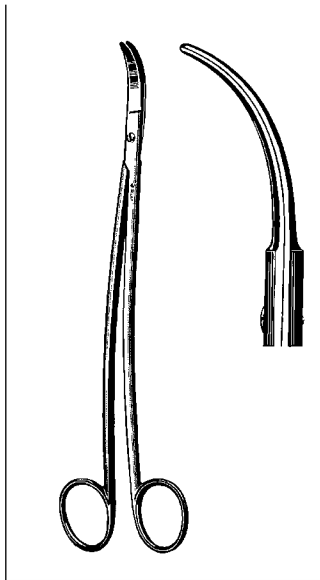
55-8380 8"



POTTS-SMITH SCISSORS

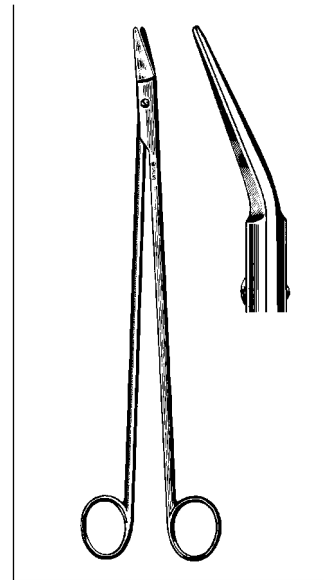
Angled

52-2825 7¼" 25°
 52-2845 7¼" 45°
 52-2860 7¼" 60°



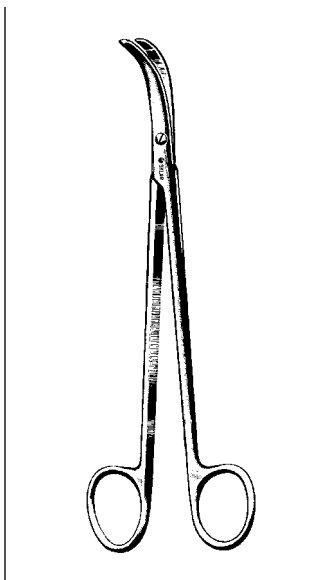
SATINSKY SCISSORS

Double Curve
 55-8495 9½"



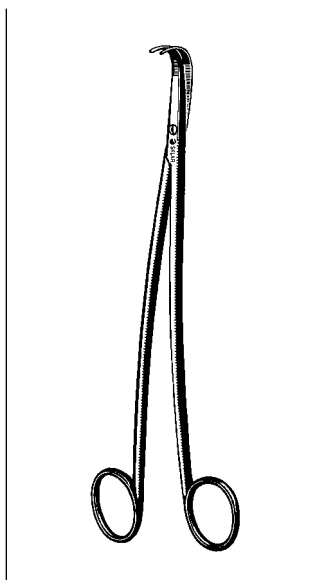
FINOCHIETTO SCISSORS

Thoracic Scissors, Angular
 55-8310 10¾"



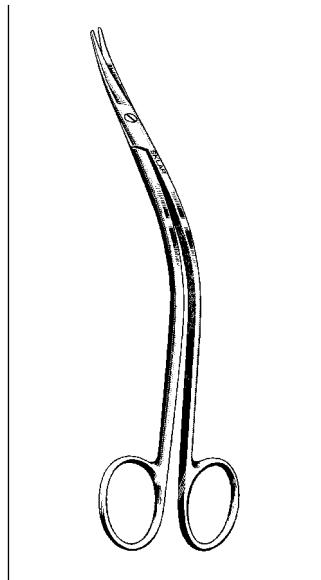
THOREK SCISSORS

Full Curve
 15-3172 7¼"
 15-3210 10"



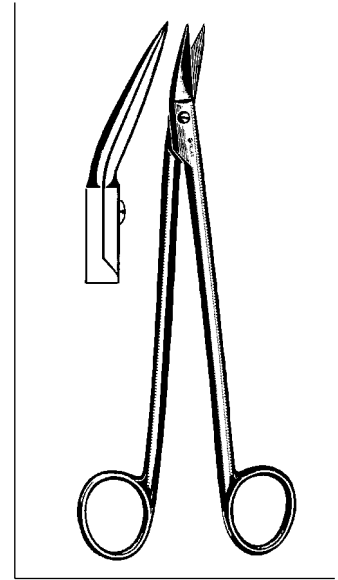
HAIMOVICI SCISSORS

Artery Scissors, Curved
 52-2985 8½"



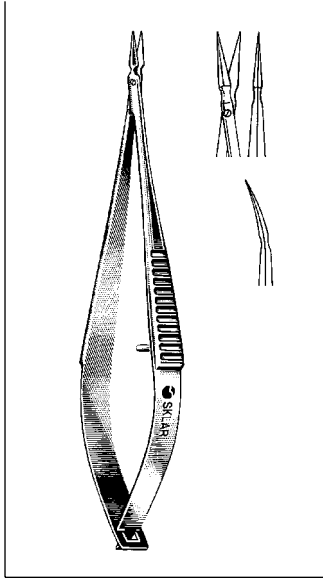
MILLER SCISSORS

Double Curve
 80-1565 6½" Serrated



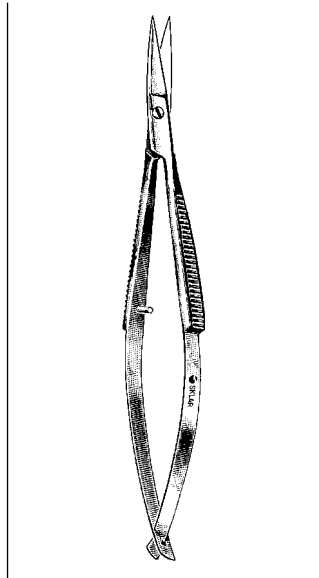
DEAN SCISSORS

Angular
 75-5267 6¾" Serrated



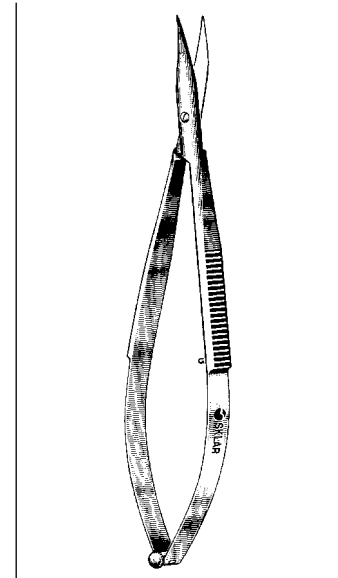
VANNAS SPRING HANDLE SCISSORS

Very Delicate
 64-1950 3" Straight
 64-1951 3" Curved



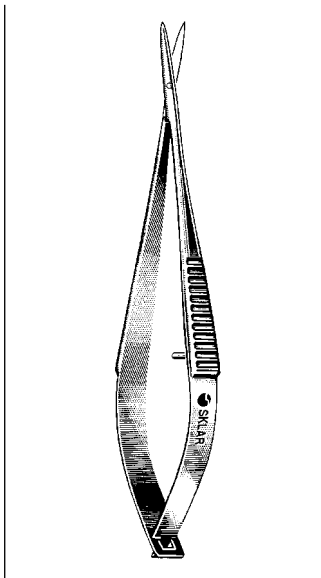
McCLURE SPRING HANDLE SCISSORS

64-1742 4 1/4" Angled
 64-1842 4 1/4" Straight
 64-1942 4 1/4" Curved



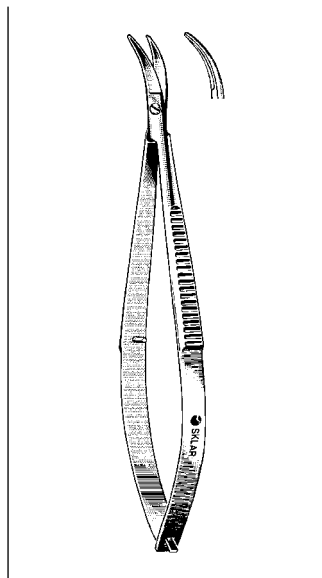
WESTCOTT TENOTOMY SCISSORS

64-3145 4 1/2" Slight Curve



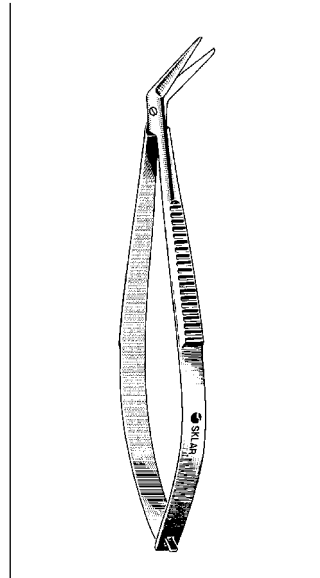
McPHERSON-VANNAS SCISSORS

Very Delicate
 64-1960 3" Straight



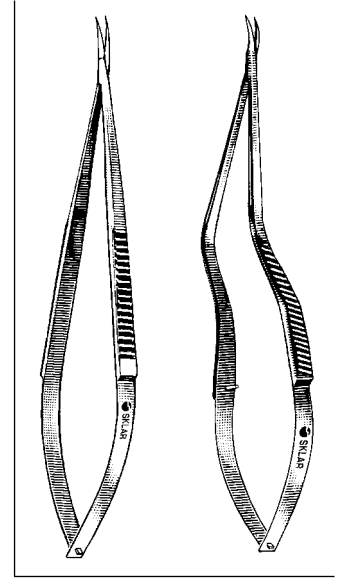
CASTROVIEJO SCISSORS

Curved
 64-2442 4 1/4" Blunt



CASTROVIEJO SCISSORS

Angular
 64-2535 4" Blunt



JACOBSON SPRING HANDLE SCISSORS

Standard
 98-1055 6 1/4" Straight
 98-1052 5 1/4" Curved
 98-1067 6 1/4" Curved
 Bayonet
 98-1070 7" Sharp
 98-1071 7" Blunt



Skларcut™ Gold-Ring Scissors Cut Cleanly and Precisely

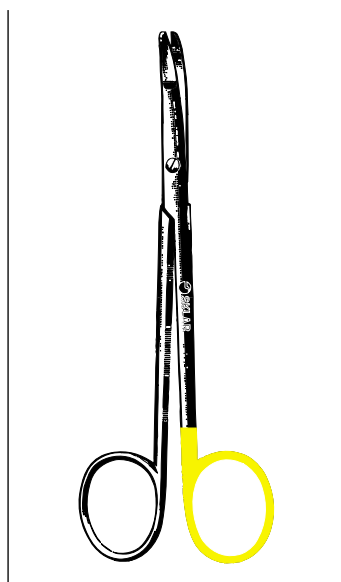
Surgical scissors are your most frequently used instrument. SKLARCUT™ scissors improve the traditional design with ultra-fine serrations on one blade.

This special feature provides for smooth and less traumatic cutting of fine and coarse tissue. One blade of these extremely high tempered scissors is precision ground, while the other blade employs extremely fine serrations that help the scissors maintain grip and accuracy throughout the entire cut.

SKLARCUT™ scissors provide users with an exceptionally sensitive “feel” and help eliminate problems associated with tissue slippage during cutting.

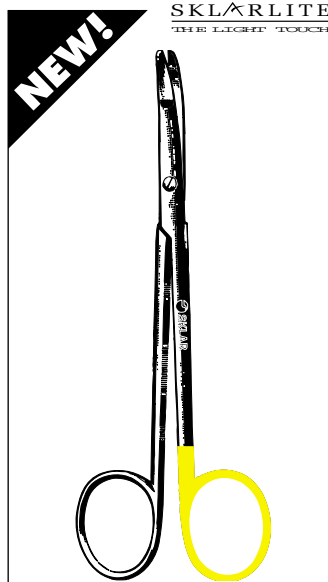
For easy visual distinction from normal scissors, the finger ring of the serrated blade is gold-coated.

Skлар Exclusive!



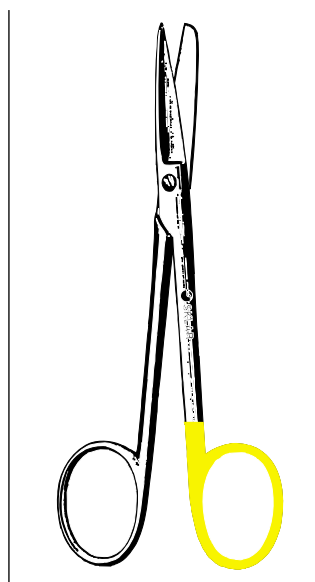
**SKLARCUT RAGNELL
DISSECTING SCISSORS**

Curved
15-3320 5"



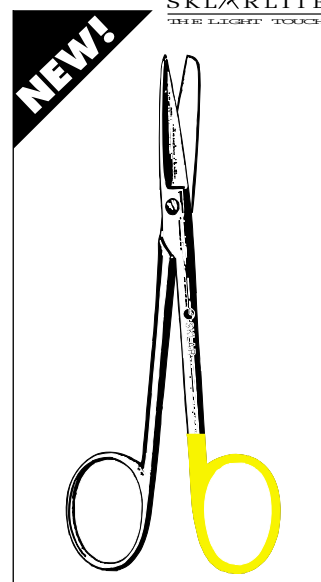
**SKLARLITE SKLARCUT
RAGNELL DISSECTING
SCISSORS**

Curved
23-1250 5"



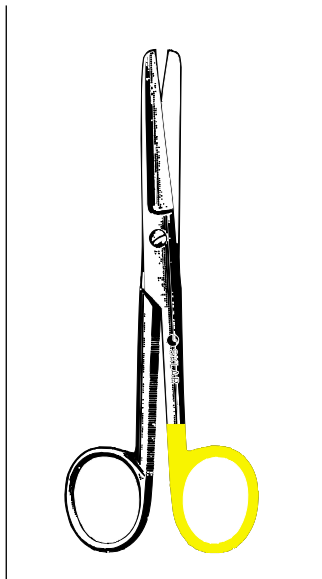
**SKLARCUT
WAGNER SCISSORS**

Straight
15-3542 4¾" S/B



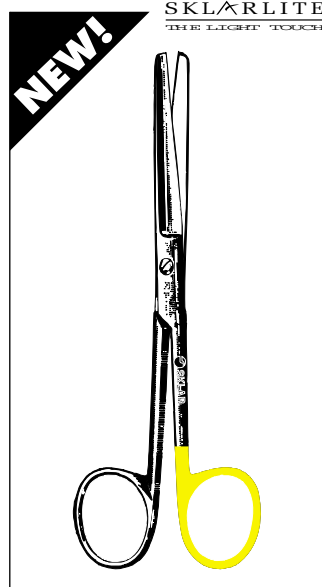
**SKLARLITE SKLARCUT
WAGNER SCISSORS**

Straight
23-1254 4¾" S/B



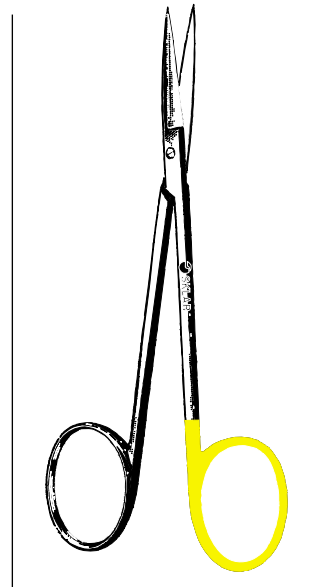
SKLARCUT OPERATING SCISSORS

Straight
 15-3500 5½" S/S
 15-3505 5½" S/B
 Curved
 15-3510 5½" S/S
 15-3515 5½" S/B



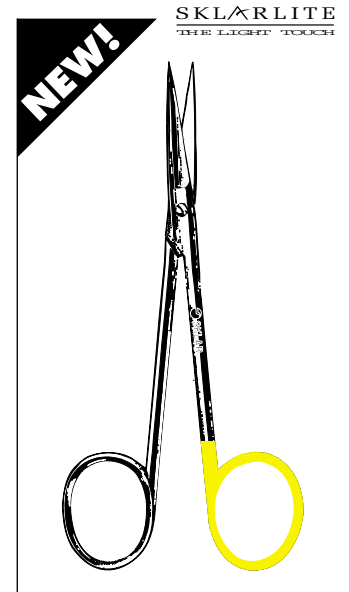
SKLARLITE SKLARCUT OPERATING SCISSORS

Straight
 23-1260 5½" S/S
 23-1262 5½" S/B
 Curved
 23-1266 5½" S/B



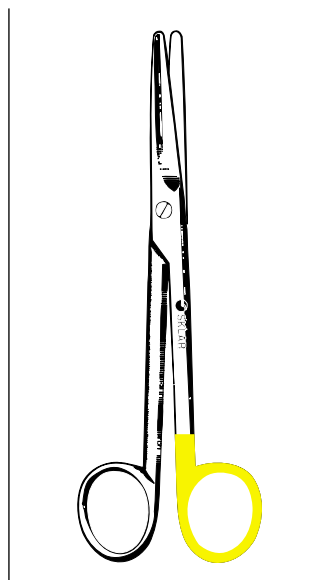
SKLARCUT IRIS SCISSORS

Straight
 15-3585 4½" S/S
 Curved
 15-3590 4½" S/S



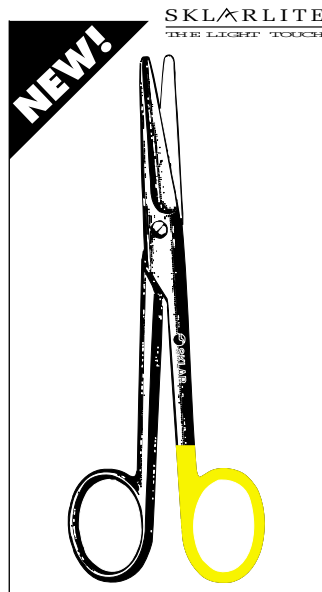
SKLARLITE SKLARCUT IRIS SCISSORS

Straight
 23-1268 4½"
 Curved
 23-1270 4½"



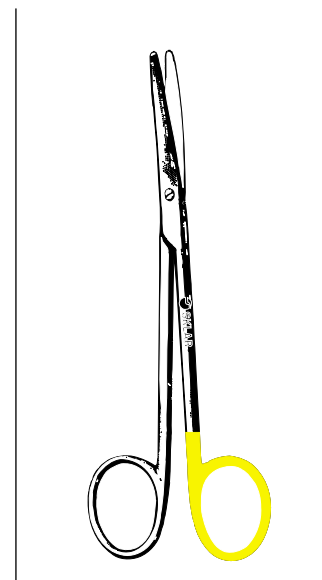
SKLARCUT MAYO DISSECTING SCISSORS

Straight	Curved
15-3550 5½"	15-3560 5½"
15-3555 6¾"	15-3565 6¾"



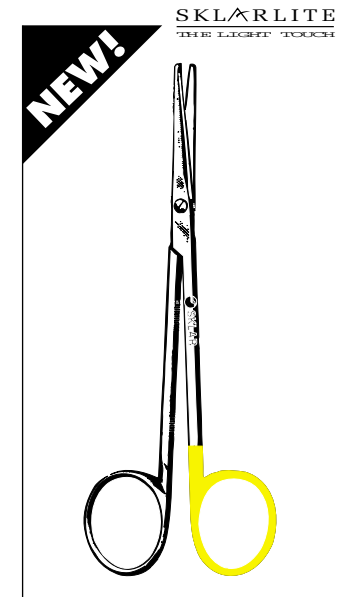
SKLARLITE SKLARCUT MAYO DISSECTING SCISSORS

Straight	Curved
23-1274 6¾"	23-1278 6¾"



SKLARCUT METZENBAUM (LAHEY) SCISSORS

Curved-Blunt
 15-3570 5¾"
 15-3575 7"



SKLARLITE SKLARCUT METZENBAUM (LAHEY) SCISSORS

Curved-Blunt
 23-1280 5¾"



Sklar Edge™ Tungsten Carbide Scissors Give You The Edge In Performance

5 Year Warranty

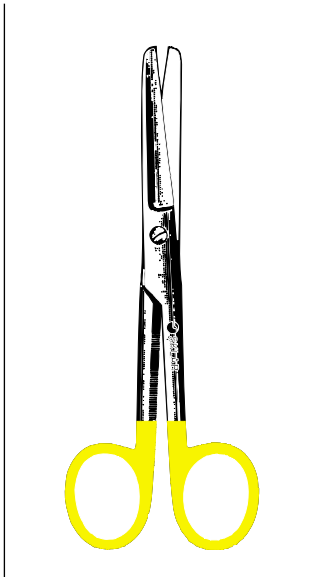
SKLAR EDGE™ tungsten carbide scissor blades are warranted for five full years of normal use. During this warranty period, if any adjustments become necessary, SKLAR will resharpen or replace the SKLAR EDGE™ tungsten carbide scissors. A nominal charge will be made for repairs once the warranty period has expired. The non T-C portion of the instrument is guaranteed under Sklar's Lifetime Warranty.



Tungsten carbide is one of the hardest alloys made. And it is tungsten carbide that gives SKLAR EDGE™ surgical scissors an exceptionally sharp and durable cutting edge – an edge that rarely needs sharpening.

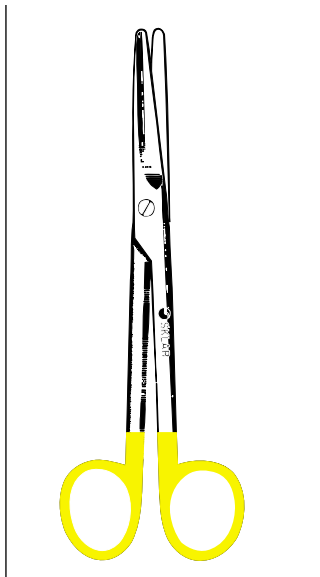
SKLAR EDGE™ scissors are specially made to perform better and stay sharper for a significantly longer period of time when compared to non-TC scissors. The unique edging process permanently bonds the tungsten carbide to your scissors giving you smooth and controlled performance, a perfectly balanced “feel” of enhanced precision and an edge guaranteed to stay sharp for five full years.

All SKLAR EDGE™ scissors come with gold plated finger rings for easy identification.



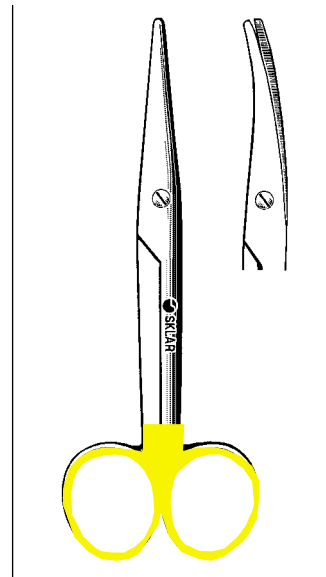
**SKLAR EDGE™
T-C OPERATING SCISSORS**

Straight		
16-1055	5½"	S/S
16-1056	5½"	S/B
16-1057	5½"	B/B
Curved		
16-1156	5½"	S/B



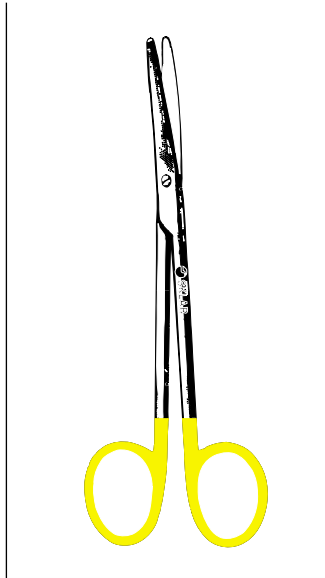
**SKLAR EDGE™
T-C MAYO DISSECTING SCISSORS**

Straight		Curved	
16-1505	5½"	16-1605	5½"
16-1510	6¾"	16-1610	6¾"
16-1515	9"	16-1615	9"



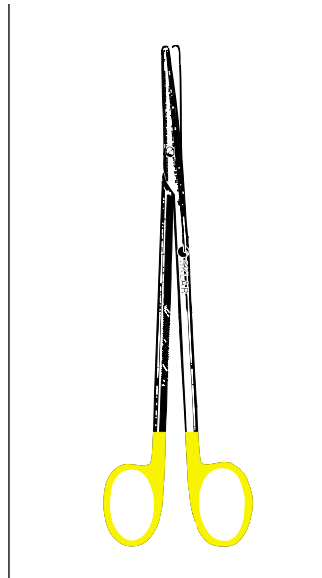
**SKLAR EDGE™
T-C MAYO-STILLE DISSECTING SCISSORS
ROUNDED BLADES**

Straight		Curved	
16-3552	5½"	16-3562	5½"
16-3557	6¾"	16-3567	6¾"



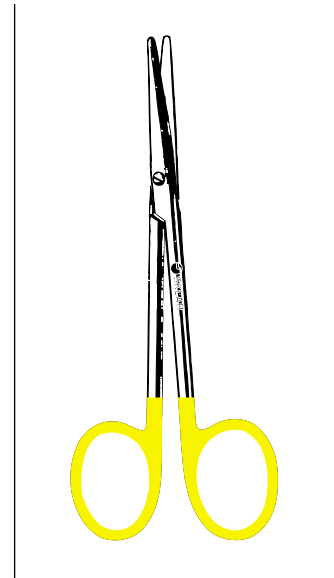
**SKLAR EDGE™
T-C METZENBAUM
(LAHEY) DISSECTING
SCISSORS**

Straight
 16-1805 5 3/4" Delicate
 16-1810 5 3/4" Standard
 Curved
 16-1905 5 3/4" Delicate
 16-1910 5 3/4" Standard



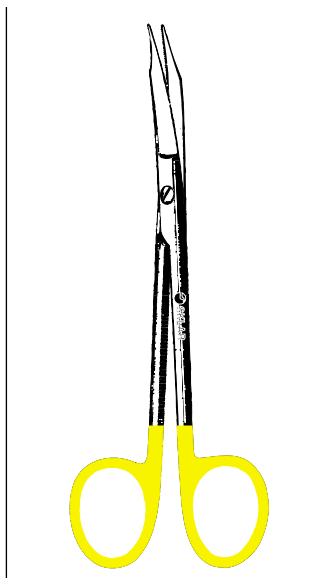
**SKLAR EDGE™
T-C METZENBAUM SCISSORS**

16-2005 7" Delicate, Straight
 16-2010 7" Standard, Straight
 16-2210 9" Standard Nelson, Straight
 16-2105 7" Delicate, Curved
 16-2110 7" Standard, Curved
 16-2310 9" Standard Nelson, Curved
 16-2115 7" Sharp/Sharp, Curved
 16-2311 11" Standard Nelson, Curved



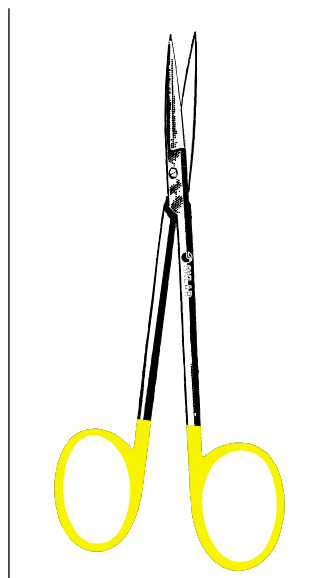
**SKLAR EDGE™
T-C STRABISMUS SCISSORS**

Straight Curved
 16-2605 4 1/2" B/B 16-2705 4 1/2" B/B



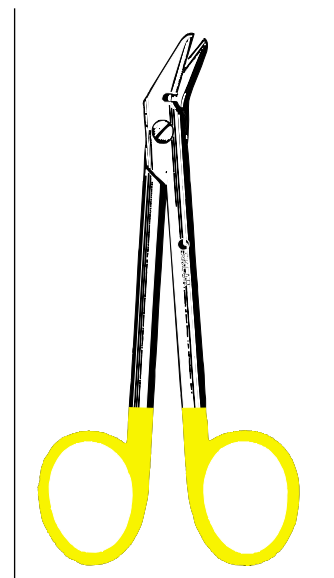
**SKLAR EDGE™
T-C DISSECTING SCISSORS**

Curved
 16-2610 5"



**SKLAR EDGE™
T-C IRIS SCISSORS**

Straight Curved
 16-2405 4 1/2" S/S 16-2505 4 1/2" S/S



**SKLAR EDGE™
T-C WIRE CUTTING SCISSORS**

Serrated Angular
 16-2800 4 3/4"



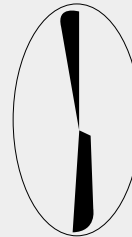
Sklarhone™ For Knife Edge Sharpness With Scissors Precision

With the addition of SKLARHONE™ premium operating room scissors, Sklar continues its effort to provide the surgeon with the most current technology and the largest selection of superior instruments.

SKLARHONE™ scissors combine the razor sharp cutting edge of a knife, with the control and precision of scissors, in one instrument. One blade on the SKLARHONE™ scissors is crafted with the cutting geometry of a knife, while the opposing blade has a standard scissors edge.

When cutting delicate tissue, SKLARHONE™ blades cut cleanly without catching or leaving minute tags. When cutting thick tissue, SKLARHONE™ scissors provide knife-like cuts that leave the edges smooth and clean.

For easy visual distinction from normal scissors, these scissors come with black handles and shafts.

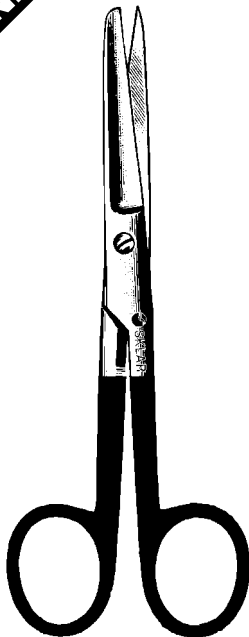


Sklarhone™ technology combines scissors action with a razor sharp knife edge.

MICRO-CUT

Sklar Exclusive!

NEW!



SKLARHONE OPERATING SCISSORS

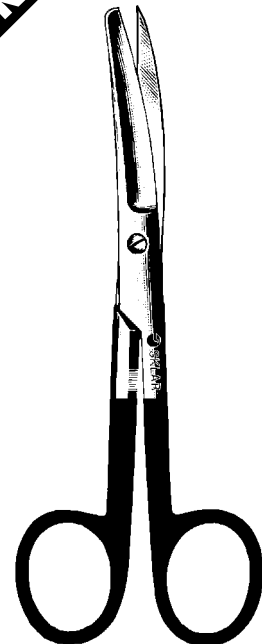
Straight Smooth

15-3342 5½" S/S
15-3343 5½" S/B

Serrated

15-3442 5½" S/S
15-3443 5½" S/B

NEW!



SKLARHONE OPERATING SCISSORS

Curved Smooth

15-3349 5½" S/B

Serrated

15-3448 5½" S/S
15-3449 5½" S/B



SKLARHONE IRIS SCISSORS

Straight Smooth	Serrated
15-3352 4½"	15-3452 4½"



SKLARHONE IRIS SCISSORS

Curved Smooth	Serrated
15-3357 4½"	15-3457 4½"



SKLARHONE METZENBAUM SCISSORS

Curved Smooth	Serrated
15-3306 6"	15-3410 7"
15-3310 7"	
15-3311 8"	
15-3315 9"	



SKLARHONE MAYO SCISSORS

Straight Smooth	Serrated
15-3325 5½"	15-3426 6¾"
15-3326 6¾"	
Curved Smooth	
15-3330 5½"	
15-3331 6¾"	



Skarlite™ Forceps Provide Lightness And Durability

SKLARLITE
THE LIGHT TOUCH

Sklar has developed a new line of premium operating room forceps that offers the surgeon maximum control and precision. Our research determined a need for forceps that were a lighter pattern while maintaining the strength and durability of a standard pattern.

Sklar has recognized the need for a manufacturing technique that mills scant microns off our standard pattern while maintaining the structural integrity of the original instrument. The result is a noticeably lighter, extremely sensitive instrument that can withstand the daily rigors of surgery.

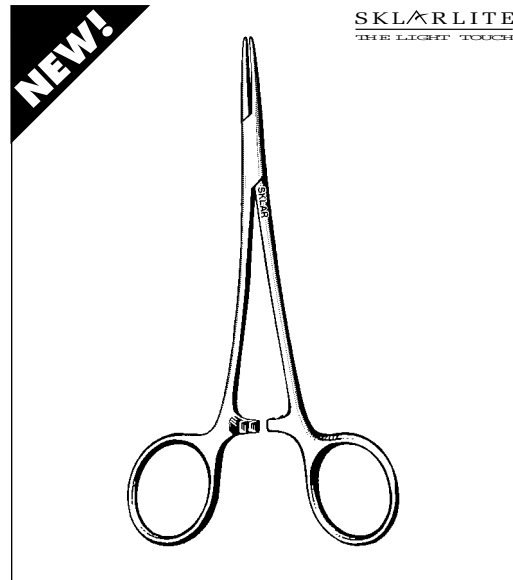
SKLARLITE™ forceps carry the same day-in and day-out reliability that you have come to expect from all Sklar instruments. Sklar has applied its more than 100 years of experience in developing this superior instrument.

SKLARLITE™ forceps are covered under the same warranty that guarantees all Sklar instruments for a lifetime of dependable use.



HALSTED MOSQUITO HEMOSTATS

Straight	Curved
17-1450 5"	17-1550 5"
17-1650 1x2 5"	17-1750 1x2 5"



SKLARLITE HALSTED MOSQUITO HEMOSTATS

Straight	Curved
23-2105 5"	23-2106 5"

Sklarlite XD™ Are The Lightest Pattern General OR Forceps Available

SKLARLITE XD
EXTRA DELICATE

Sklar Instruments has surpassed industry standards by developing a delicate pattern operating room forceps that offers the surgeon one of the lightest general surgery forceps on the market today. For the surgeon who demands the finest in OR forceps, *Sklar is the choice.*

Sklar employs the same manufacturing process used in making the SKLARLITE™ forceps and mills scant microns off our delicate pattern while maintaining its structural integrity. The result is the most delicate and sensitive forceps available today.

SKLARLITE XD™ forceps carry the same day-in and day-out reliability that you have come to expect from all Sklar instruments. Sklar has applied its more than 100 years of experience in developing this superior instrument.

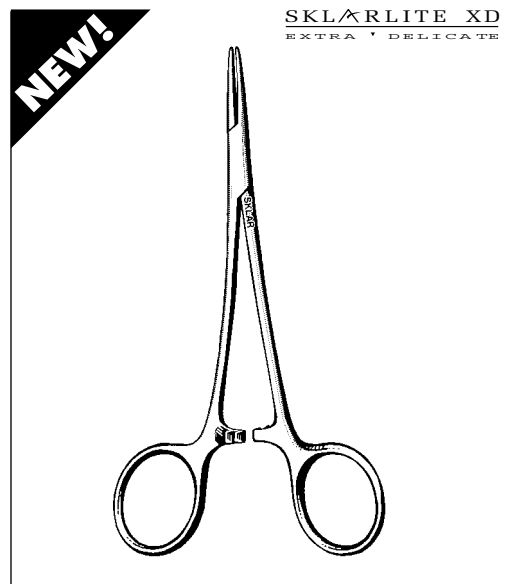
SKLARLITE XD™ forceps are covered under the same warranty that guarantees them for a lifetime of dependable use.



HALSTED MOSQUITO HEMOSTATS DELICATE

Straight
18-1050 5"

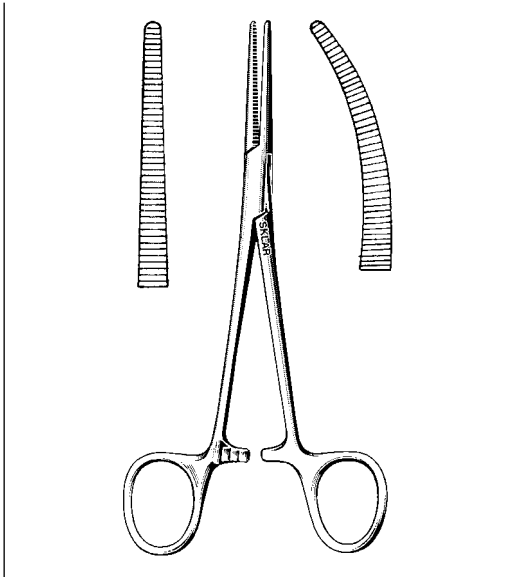
Curved
18-1150 5"



SKLARLITE EXTRA DELICATE HALSTED MOSQUITO HEMOSTATS

Straight
23-2505 5"

Curved
23-2506 5"



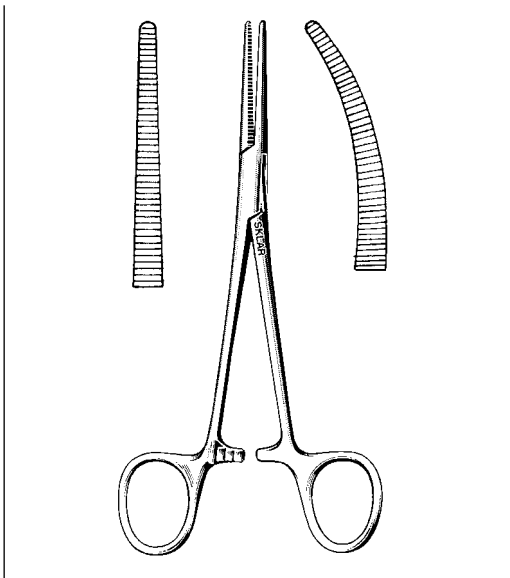
CRILE HEMOSTATIC FORCEPS

Straight		Curved	
17-3055	5½"	17-3155	5½"
17-3062	6¼"	17-3162	6¼"
17-3075	7½"	17-3175	7½"



SKLARLITE CRILE HEMOSTATIC FORCEPS

Straight		Curved	
23-2110	5½"	23-2113	5½"



CRILE HEMOSTATIC FORCEPS DELICATE

Straight		Curved	
18-1952	5½"	18-2052	5½"



SKLARLITE EXTRA DELICATE CRILE HEMOSTATIC FORCEPS

Straight		Curved	
23-2510	5½"	23-2513	5½"



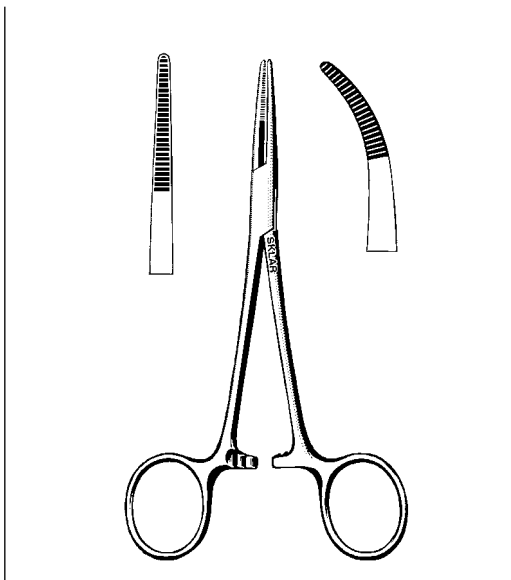
KELLY HEMOSTATIC FORCEPS

Straight	Curved
17-2055 5½"	17-2155 5½"
	74-3270 7" Extra Heavy



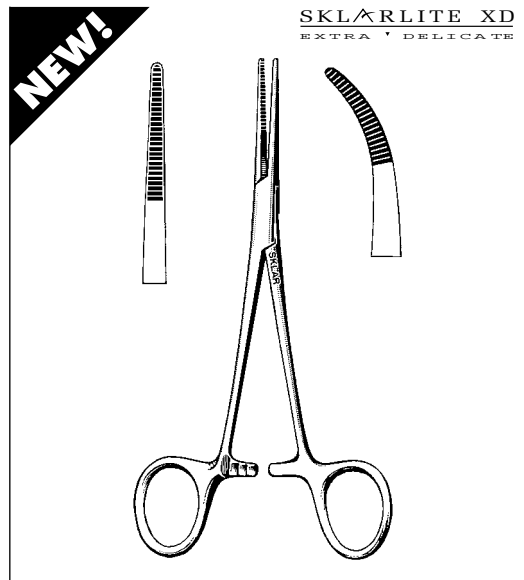
**SKLARLITE
KELLY HEMOSTATIC FORCEPS**

Straight	Curved
23-2107 5½"	23-2108 5½"



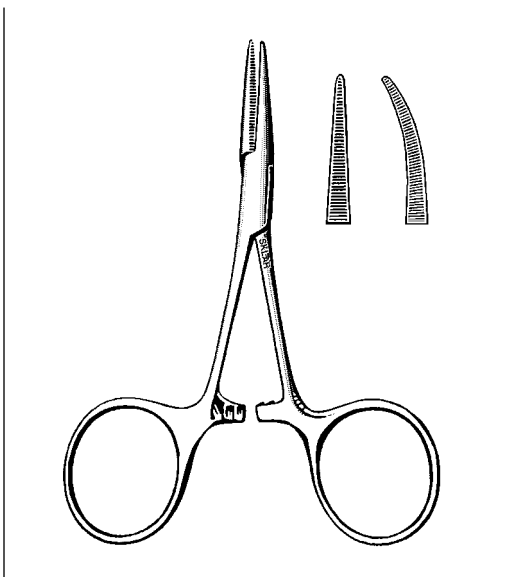
**KELLY HEMOSTATIC FORCEPS
DELICATE**

Straight	Curved
18-1552 5½"	18-1652 5½"



**SKLARLITE EXTRA DELICATE
KELLY HEMOSTATIC FORCEPS**

Straight	Curved
23-2507 5½"	23-2508 5½"



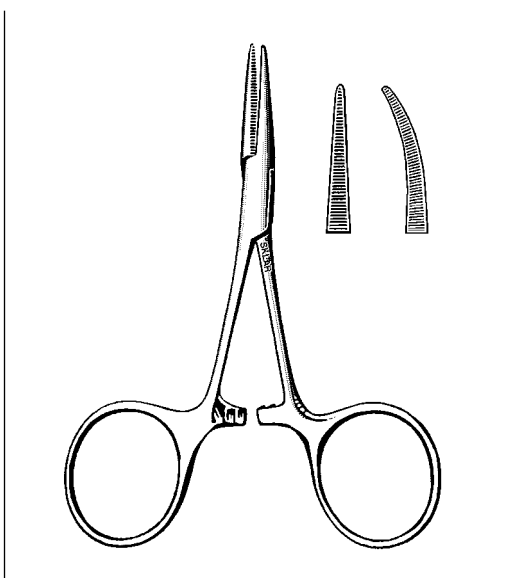
HARTMANN MOSQUITO HEMOSTATS

Straight	Curved
17-1235 3½" Serrated	17-1335 3½" Serrated



SKLARLITE HARTMANN MOSQUITO HEMOSTATS

Straight	Curved
23-2100 3½"	23-2101 3½"



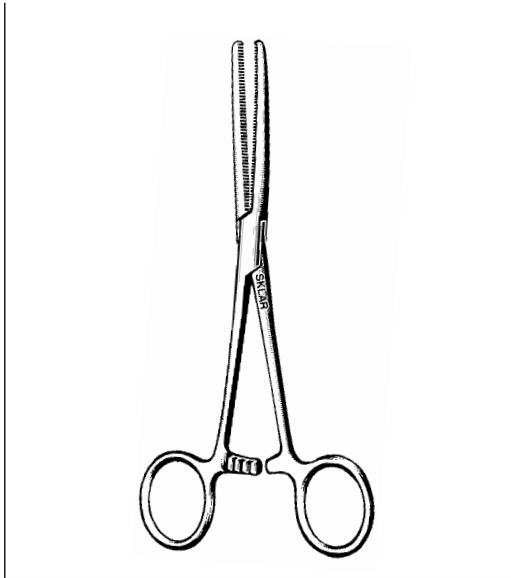
HARTMANN MOSQUITO HEMOSTATS DELICATE

Straight	Curved
17-1230 3½"	17-1232 3½"



SKLARLITE EXTRA DELICATE HARTMANN MOSQUITO HEMOSTATS

Straight	Curved
23-2500 3½"	23-2501 3½"



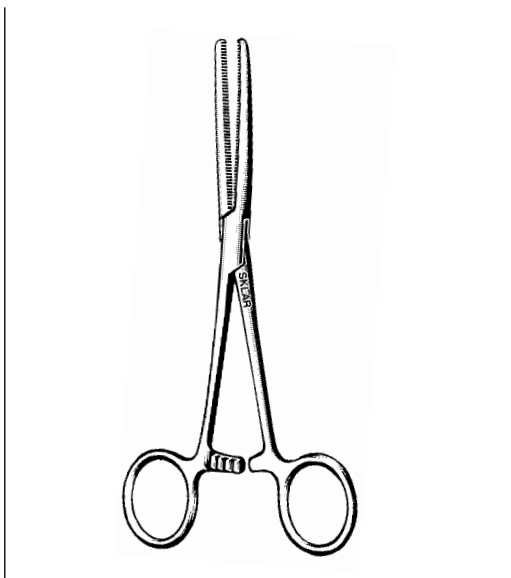
ROCHESTER-PEAN FORCEPS

Straight		Curved	
17-2455	5½"	17-2255	5½"
17-2462	6¼"	17-2262	6¼"
17-2467	6¾" Heavy	17-2267	6¾" Heavy
17-2472	7¼"	17-2272	7¼"
17-2480	8"	17-2280	8"
36-2690	9"	36-2790	9"
36-2710	10¼"	36-2810	10¼"



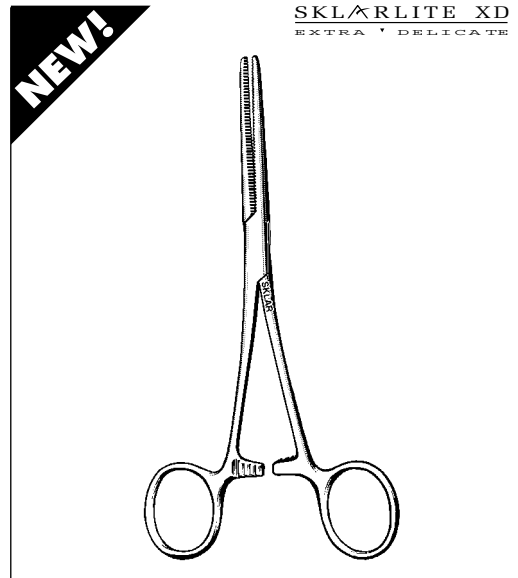
SKLARLITE ROCHESTER-PEAN FORCEPS

Straight		Curved	
23-2532	6¼"	23-2538	6¼"
		23-2542	7¼"



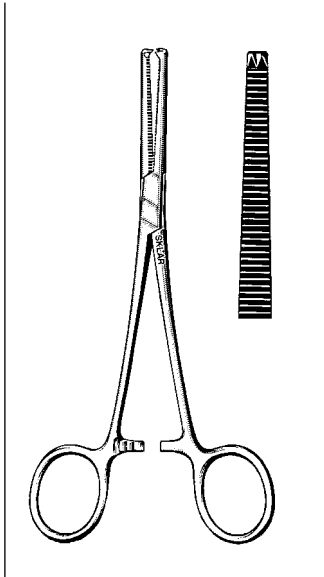
ROCHESTER-PEAN FORCEPS DELICATE

Straight		Curved	
22-3555	5½"	22-3655	5½"
		17-2362	6¼"
		22-2272	7¼"
		22-2280	8"



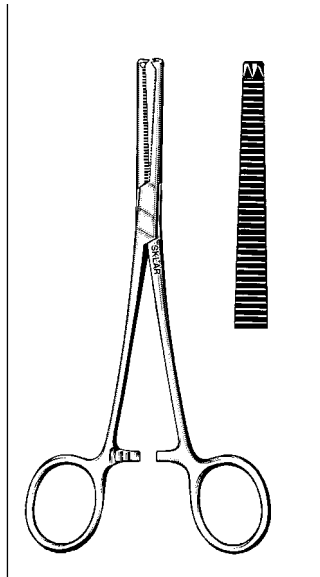
SKLARLITE EXTRA DELICATE ROCHESTER-PEAN FORCEPS

Straight		Curved	
23-2552	6¼"	23-2561	6¼"
		23-2563	7¼"



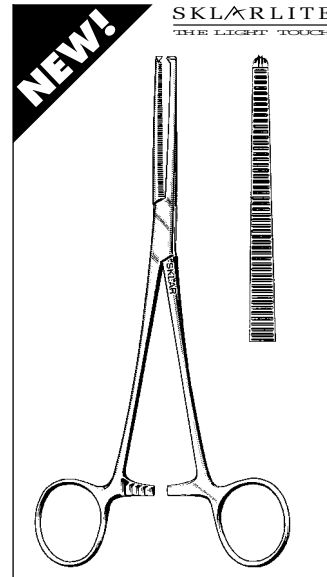
ROCHESTER-OCHSNER FORCEPS

Straight	1x2 Teeth	Curved	1x2 Teeth
17-2855	5½" (Kocher)	17-2655	5½" (Kocher)
17-2862	6¼"	17-2662	6¼"
17-2872	7¼"	17-2672	7¼"
17-2880	8"	17-2680	8"



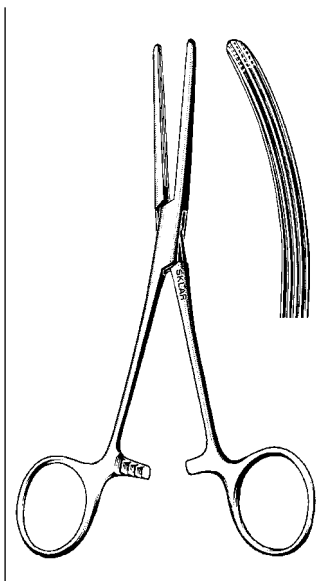
ROCHESTER-OCHSNER FORCEPS DELICATE

Straight	1x2 Teeth	Curved	1x2 Teeth
18-1752	5¼"	18-1852	5¼"
22-3755	5½" Pediatric	22-3855	5½" Pediatric
17-2962	6¼"	17-2762	6¼"



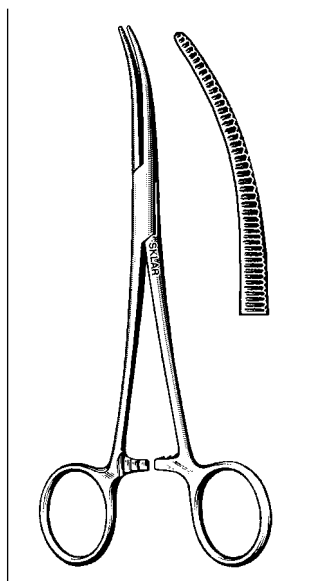
SKLARLITE ROCHESTER-OCHSNER FORCEPS

Straight	1x2 Teeth
23-2560	6¼"
Curved	1x2 Teeth



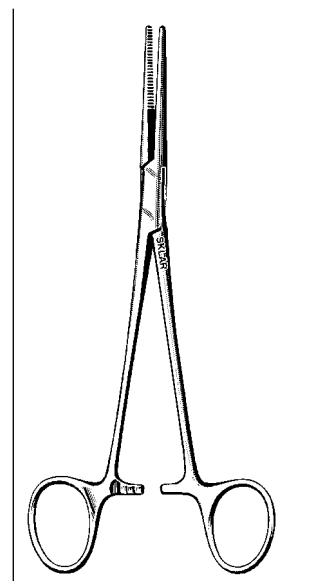
ROCHESTER-CARMALT FORCEPS

Straight	Curved
17-1062	6¼"
17-1080	8"
17-1162	6¼"
17-1180	8"



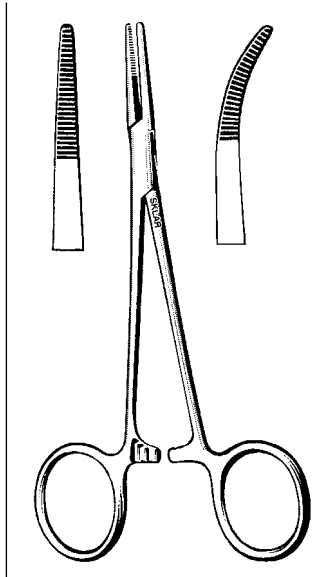
COLLER HEMOSTATIC FORCEPS

Straight	Curved
17-3455	5½"
17-3265	6¼"
17-3275	7½"
17-3555	5½"
17-3365	6¼"
17-3375	7½"



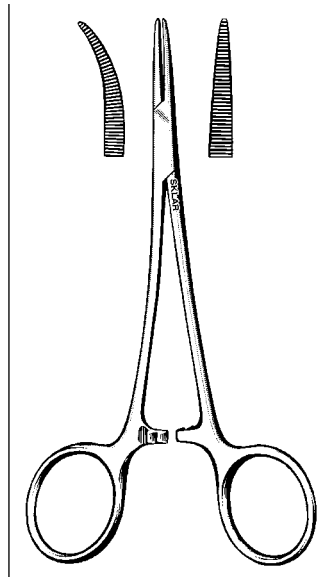
RANKIN HEMOSTATIC FORCEPS

17-1262 6¼" Straight



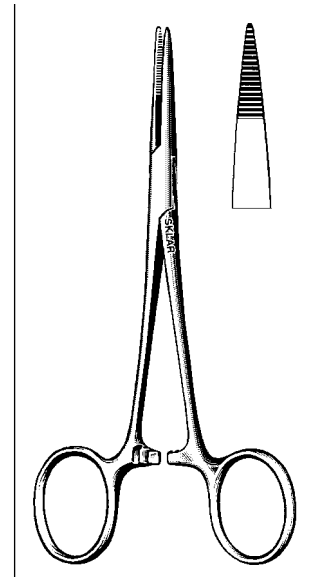
**PROVIDENCE HOSPITAL
FORCEPS**

Straight		Curved	
17-1855	5½"	17-1955	5½"
18-1352	5½"	18-1452	5½"
	Delicate		Delicate



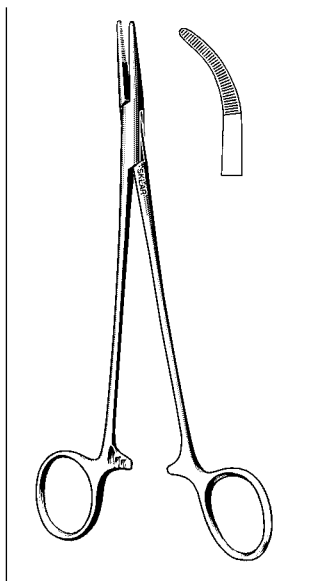
**THOMSON MOSQUITO
FORCEPS**

Pediatric			
22-3047	5"	Straight	
22-3147	5"	Curved	



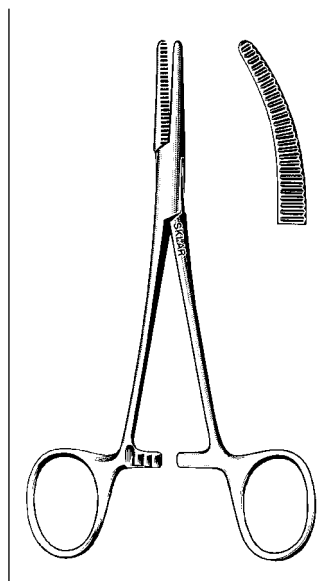
**JOHNS HOPKINS
MOSQUITO FORCEPS**

17-1155 5½" **Straight**



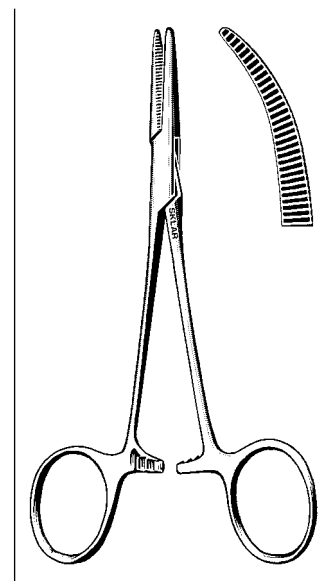
ADSON FORCEPS

50-1372	7¼"	Straight
50-1472	7¼"	Curved



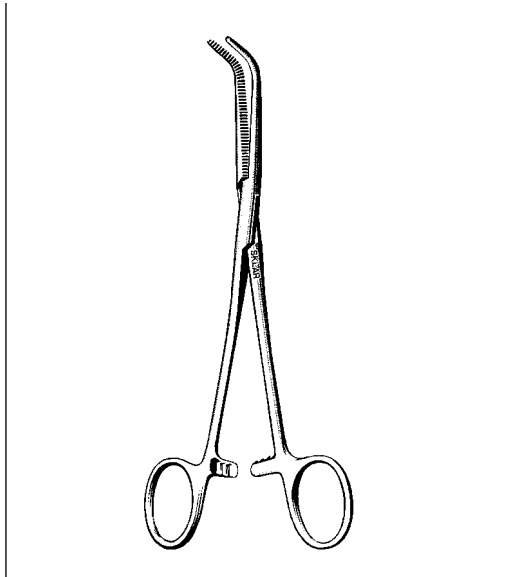
LAHEY FORCEPS

17-3255	5½"	Straight
17-3355	5½"	Curved



JONES FORCEPS

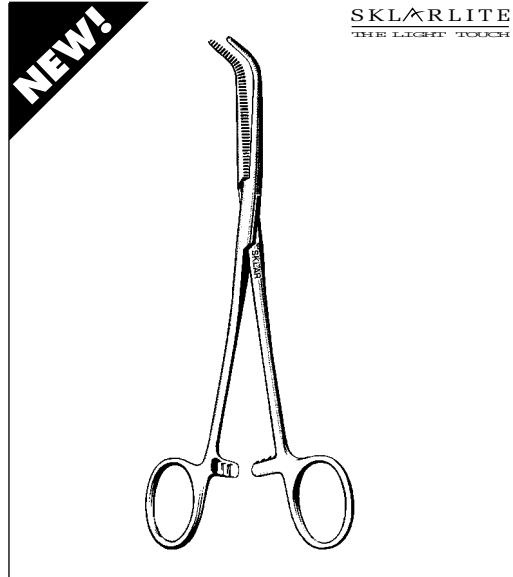
17-1255	5½"	Straight
17-1355	5½"	Curved



MIXTER FORCEPS

Right Angle

18-1250	5½"	55-2892	9¼"	Heavy
17-1762	6¼"	55-2894	10½"	Longitudinal
17-1772	7¼"			Serrations Heavy
		55-3012	12"	Longitudinal
				Serrations Heavy

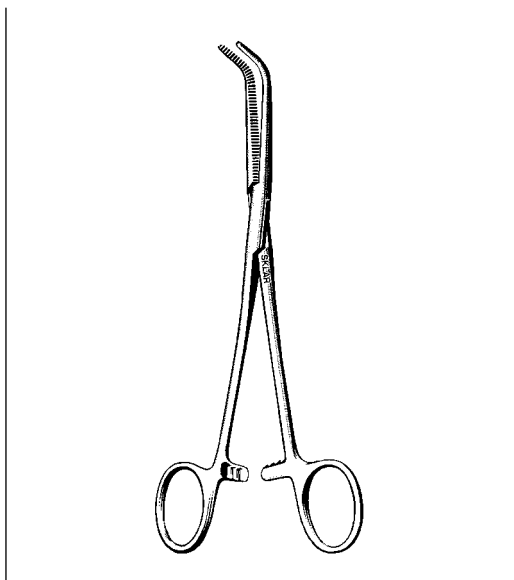


SKLARLITE
THE LIGHT TOUCH

SKLARLITE MIXTER FORCEPS

Right Angle

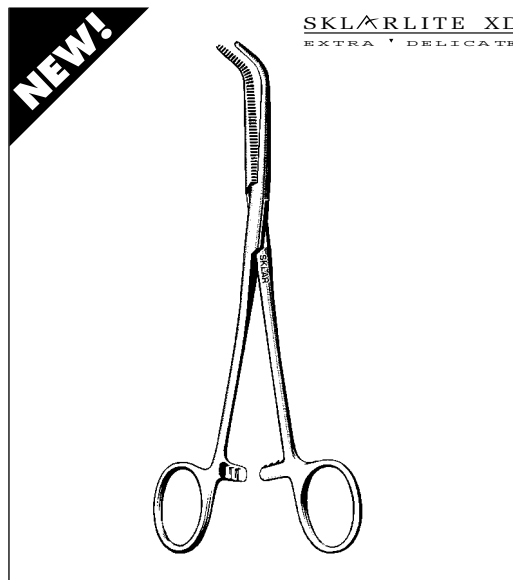
23-2516	5½"
23-2520	7¼"



MIXTER FORCEPS DELICATE

Right Angle

22-3255	5½"	55-2892	9"
22-3270	7"		

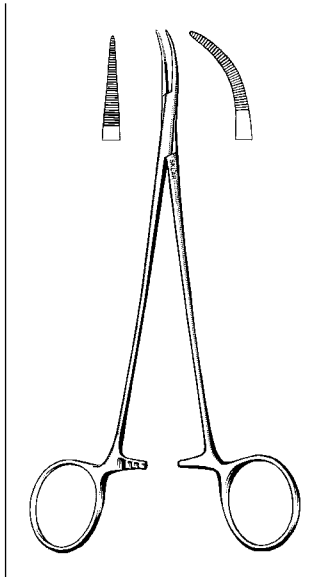


SKLARLITE XD
EXTRA DELICATE

SKLARLITE EXTRA DELICATE MIXTER FORCEPS

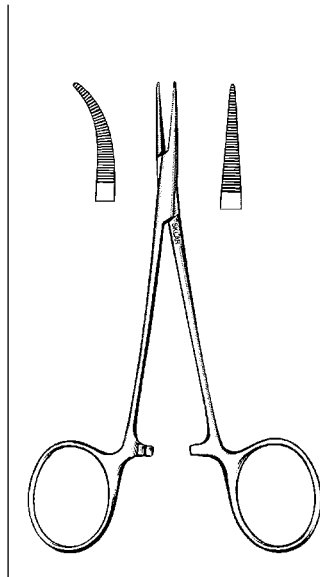
Right Angle

23-2521	5½"
23-2525	7"



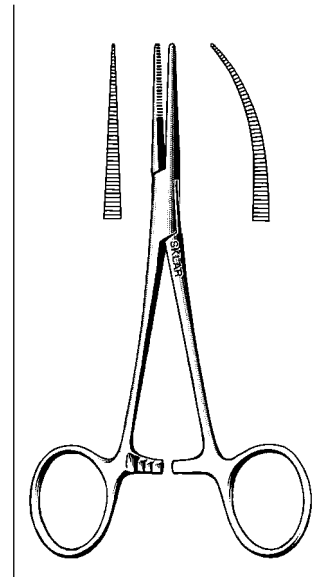
**JACOBSON MOSQUITO
FORCEPS EXTRA
DELICATE**

98-2070 7" Slight Curve
98-2071 7" Full Curve



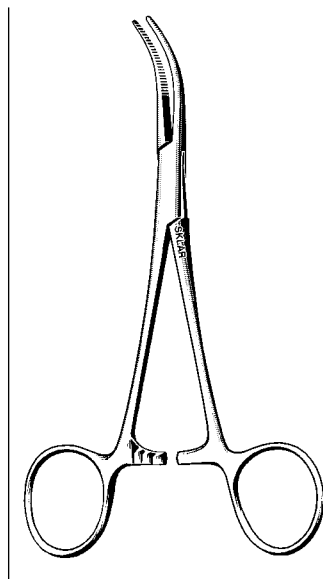
**JACOBSON MOSQUITO
FORCEPS DELICATE**

98-2050 5" Straight
98-2051 5" Curved



**MICRO MOSQUITO
FORCEPS**

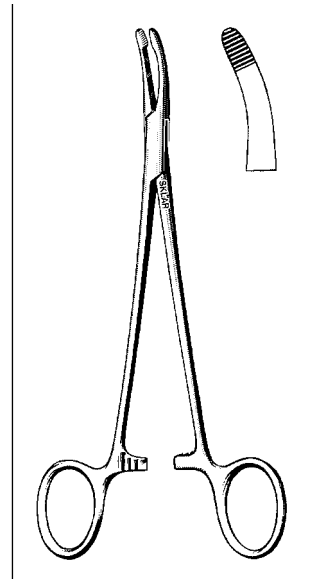
17-1220 4 3/4" Straight
17-1225 4 3/4" Curved



**DANDY SCALP
HEMOSTAT**

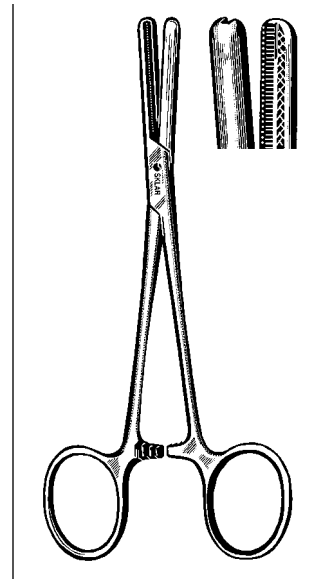
Curved to Side

50-1355 5 1/2" Serrated
50-1357 5 1/2" Serrated 1 x 2 Teeth



DAVIS FORCEPS

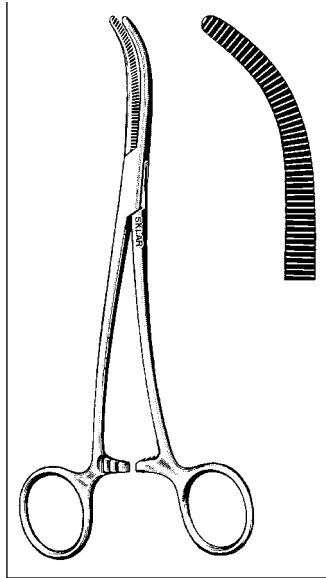
74-3070 7" Curved



FERGUSON FORCEPS

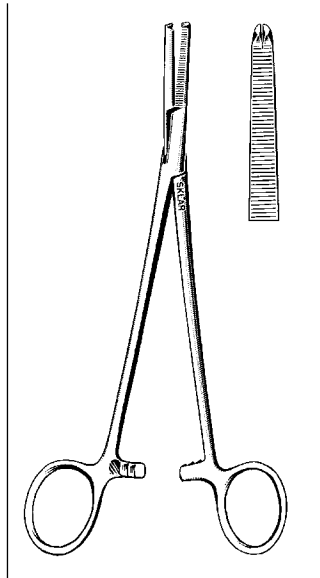
17-1260 6" Straight
17-1360 6" Curved

FORCEPS



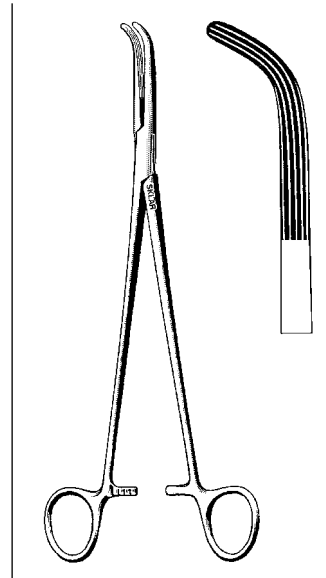
SHALLCROSS FORCEPS

32-2070 7" Double Curved



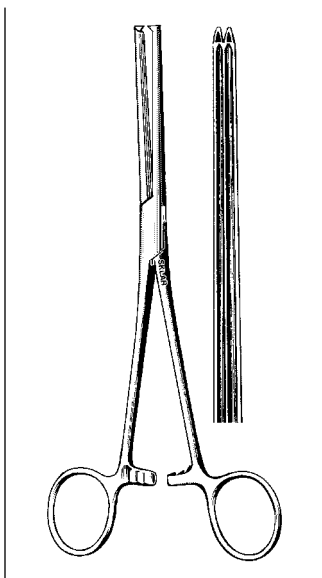
O'HANLON INTESTINAL CLAMP

36-4082 8 1/4"



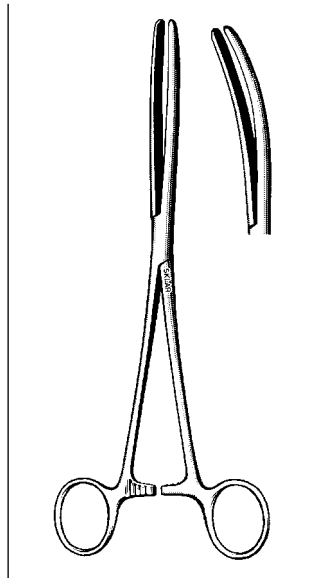
LAHEY FORCEPS

32-1875 7 1/2"
32-1890 9"
32-1990 9" Heavy



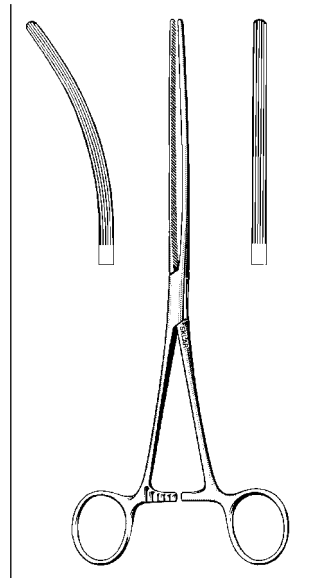
ALLEN INTESTINAL CLAMP

Longitudinal Serrations, Straight
36-3180 8" 1 x 2
36-3195 9 1/2" 1 x 2



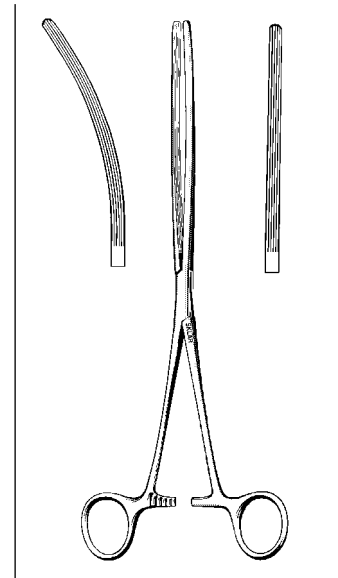
PEAN INTESTINAL CLAMP

Longitudinal Serrations
Straight Curved
36-2880 8" 36-2962 6 1/4"
36-2890 9" 36-2990 9"
36-2895 9 1/2" 36-2995 9 1/2"



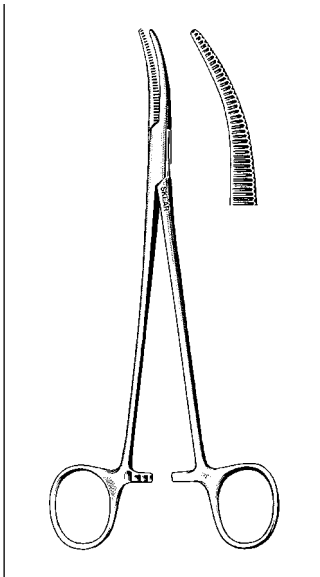
DOYEN FORCEPS

36-3590 9" Straight
36-3690 9" Curved
Diagonal Serrations
36-3790 9" Straight



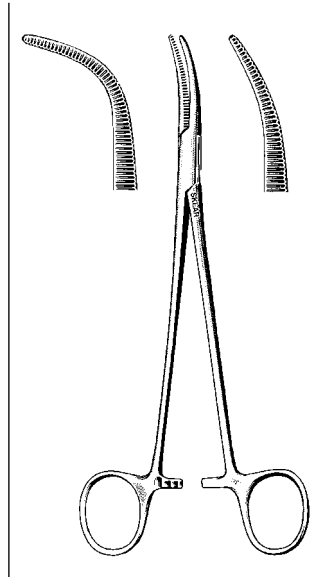
MAYO-ROBSON FORCEPS

36-3210 10" Straight
36-3310 10" Curved



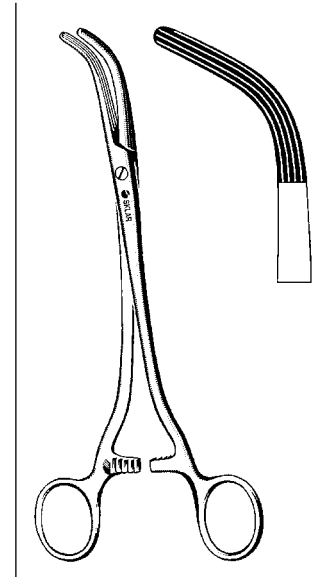
**SKLAR RANKIN
FORCEPS**

17-1775 7½" Shallow Curve



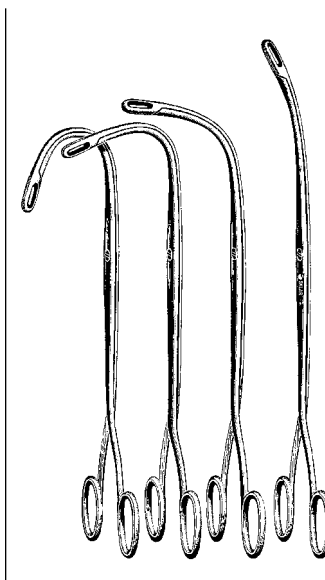
VARCO FORCEPS

32-2075 7½" Shallow Curve
32-2175 7½" Full Curve



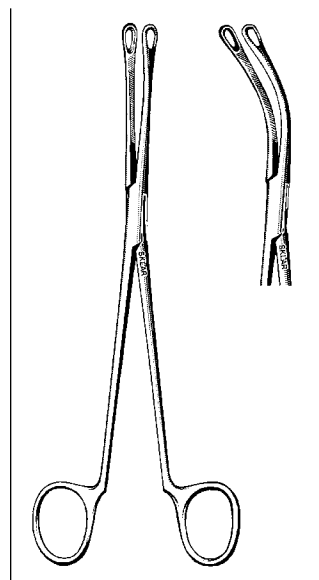
CRILE DUCT FORCEPS

32-1780 8"



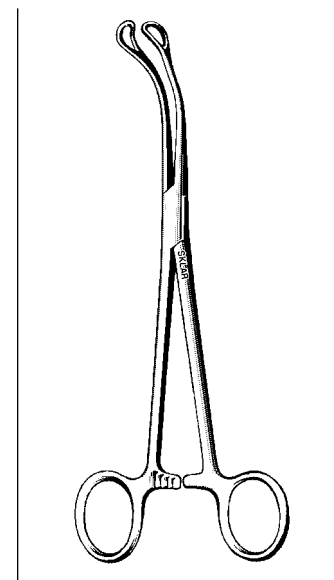
RANDALL STONE FORCEPS

33-1001 9¼" ¼ Curved
33-1002 8½" ½ Curved
33-1003 7¾" ¾ Curved
33-1004 7¾" Full Curved



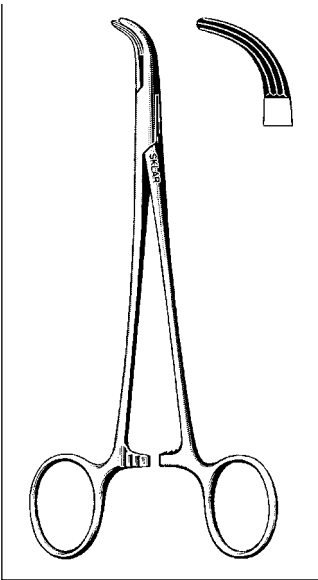
**BLAKE GALLSTONE
FORCEPS**

32-2782 8¼" Curved
32-2785 8½" Straight



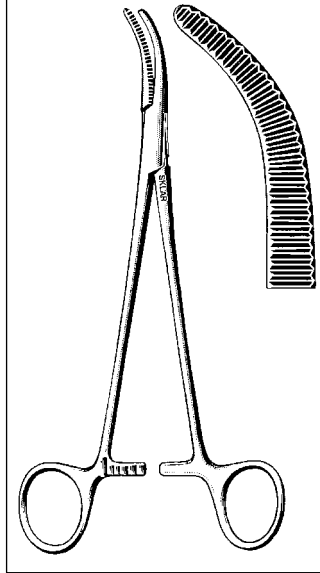
**MAYO-BLAKE
GALLSTONE FORCEPS**

32-2880 8" Straight
32-2980 8" Curved



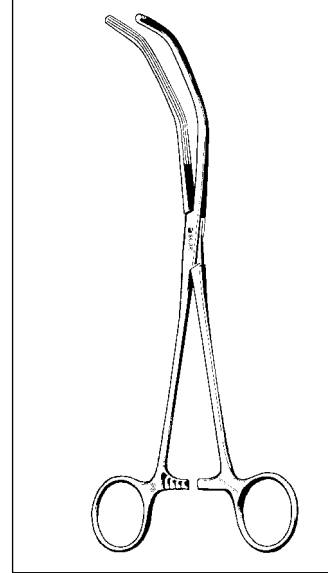
**LOWER GALL DUCT
FORCEPS**

32-1870 7"



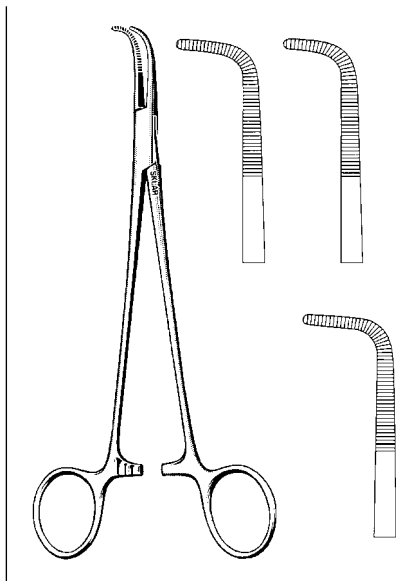
MOYNIHAN FORCEPS

32-1785 8½"



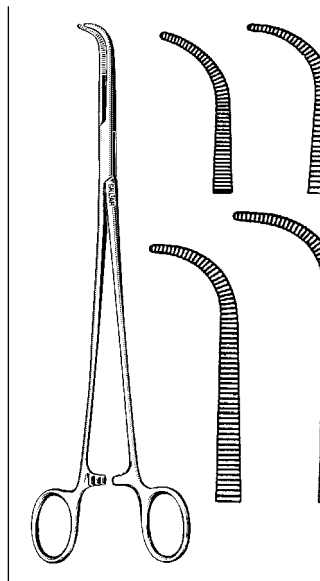
**HERRICK KIDNEY
CLAMP**

33-1297 9½"



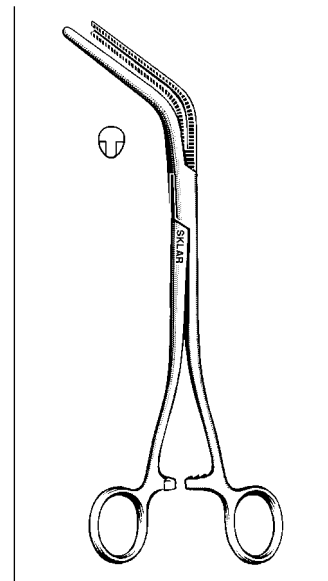
KANTROWITZ CLAMP

55-2775 7½"
55-2795 9½"
55-2810 10½"



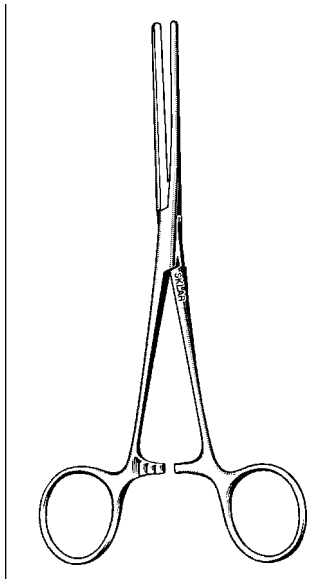
**GEMINI FORCEPS
DELICATE RIGHT ANGLE**

55-2855 5"
55-2870 6¼"
55-2880 8"
55-2890 9"

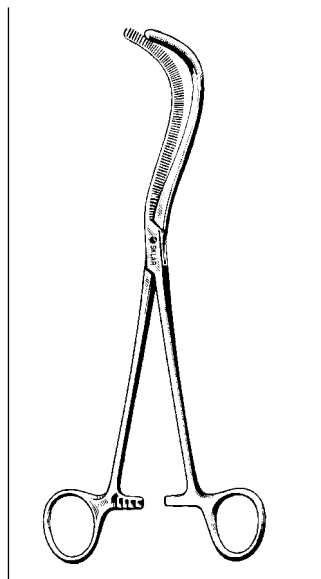


**PEMBERTON
ANASTOMOSIS CLAMP**

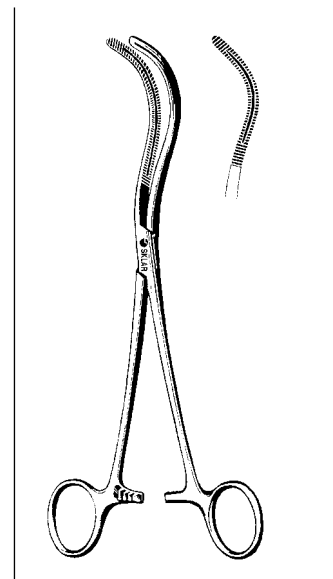
Angiotribe Jaw
36-4490 9"



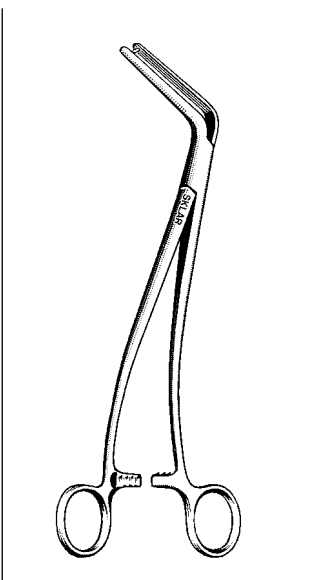
SCUDDER FORCEPS
Pediatric
22-6260 6" Straight, Smooth



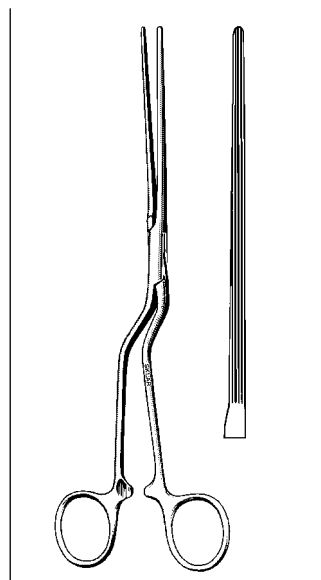
MAYO-GUYON KIDNEY CLAMP
33-1090 9"



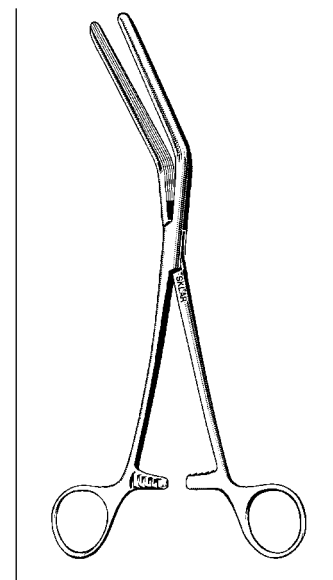
STILLE KIDNEY CLAMP
33-1190 9"



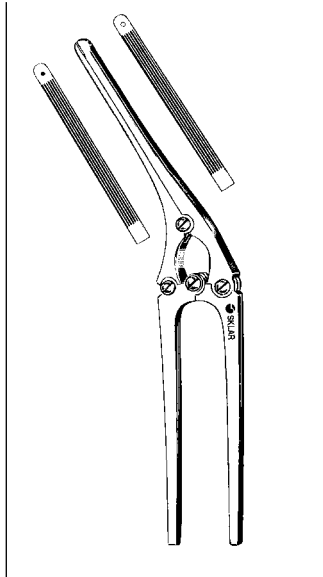
FOSS INTESTINAL FORCEPS
Angular
36-4411 11½"



GAVIN MILLER BAYONET FORCEPS
36-4180 8"

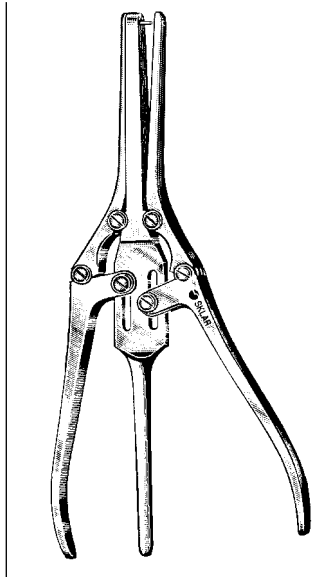


OCKERBLAD FORCEPS
33-1585 8½"



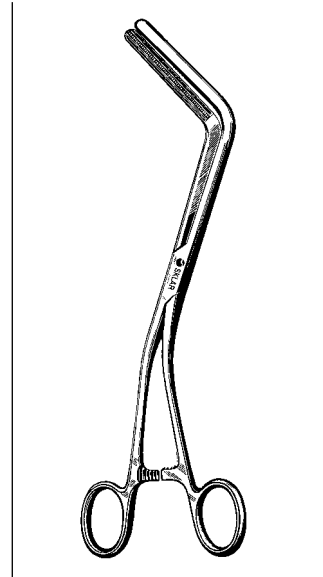
PAYR PYLORUS CLAMP

22-6457 5 3/4" Lt.
 36-4280 8"
 36-4311 11"
 36-4313 13"



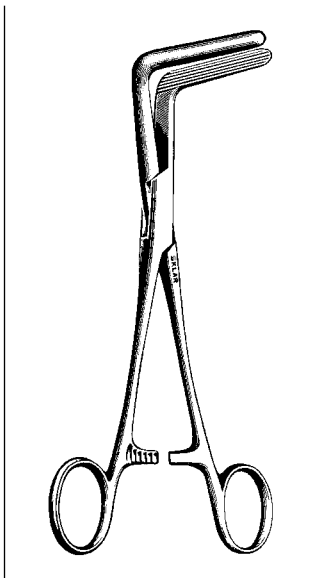
RANKIN ANASTOMOSIS CLAMP

36-4590 9"



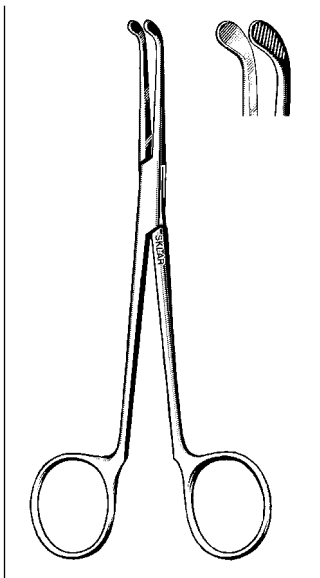
SKLAR INTESTINAL FORCEPS

2 1/2" Jaw
 36-7010 10" Heavy



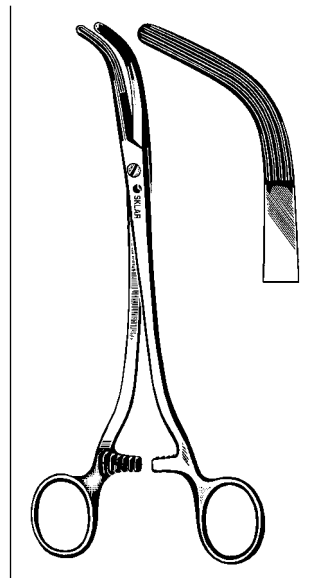
WERTHEIM-CULLEN PEDICLE CLAMP

2 1/2" Jaw
 33-1375 7 1/2"



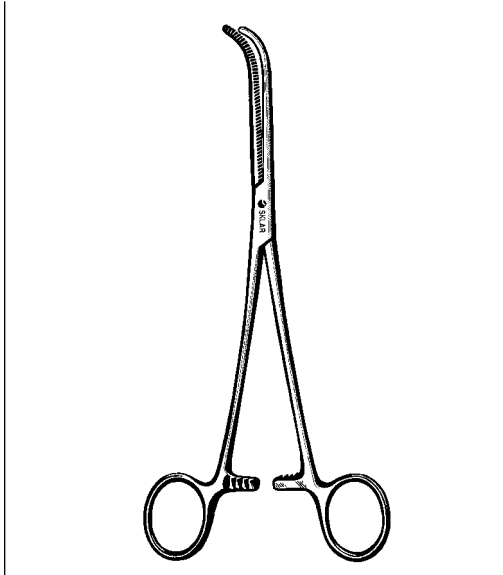
BENSON PYLORUS SEPARATOR

22-6557 5 3/4"



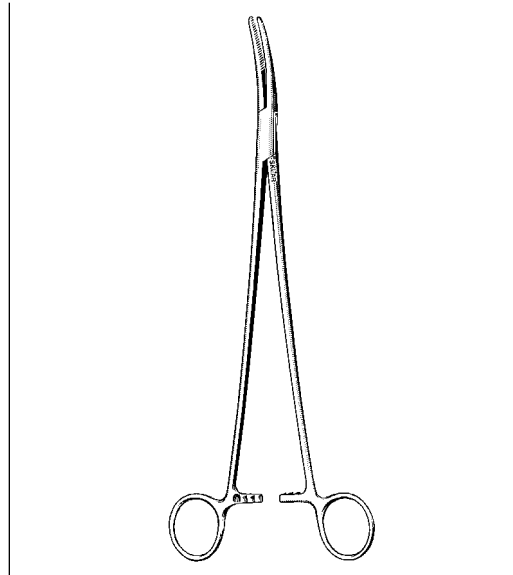
CRILE GALL DUCT FORCEPS

32-1780 8"



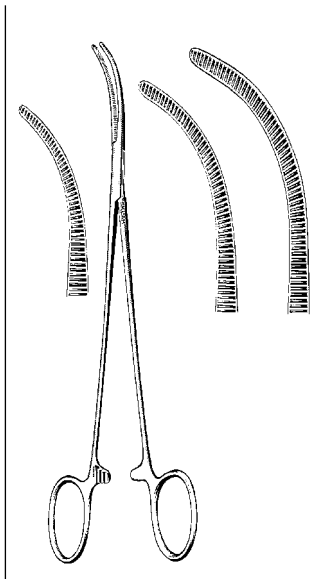
**JOHN HOPKINS GALL
BLADDER FORCEPS**

32-1680 8"



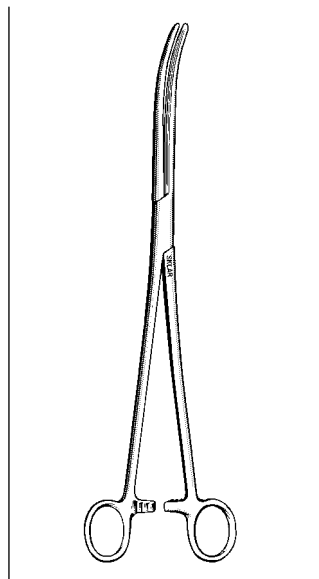
SKLAR THORACIC CLAMP

55-3080 8" Curved
55-3110 10 1/2" Curved



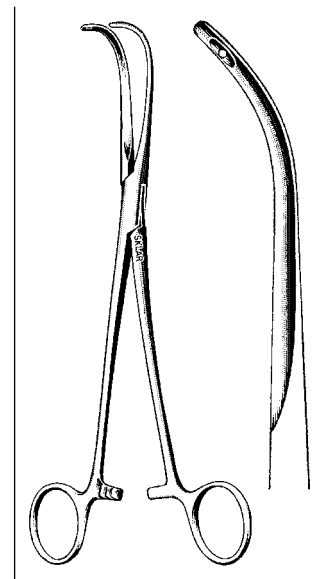
OVERHOLT FORCEPS

55-2187 8 1/2" Small Jaw
55-2190 8 1/4" Medium Jaw
55-2195 8 1/4" Long Jaw



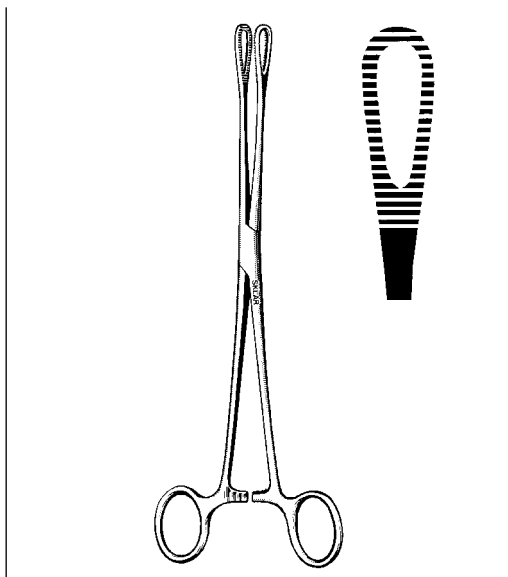
HARRINGTON FORCEPS

55-2112 12" Curved Longitudinal
Serrations



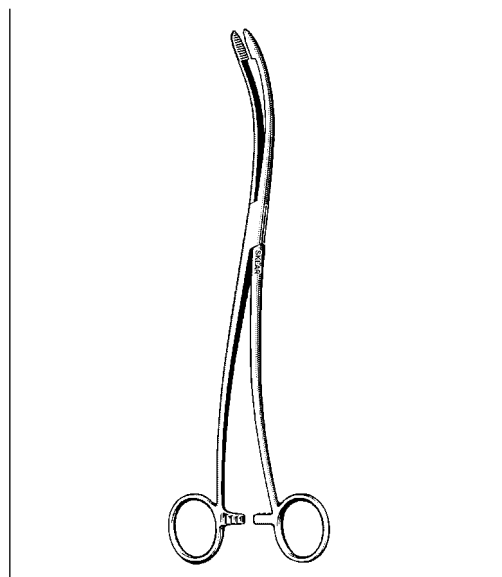
**SEMB DISSECTING
FORCEPS**

55-2395 9 1/2" Shallow Curve
55-2397 9 1/2" Full Curve



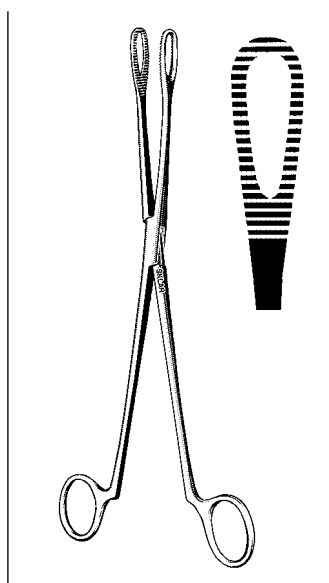
SCHWEIZER FORCEPS

90-7995 9½" Straight



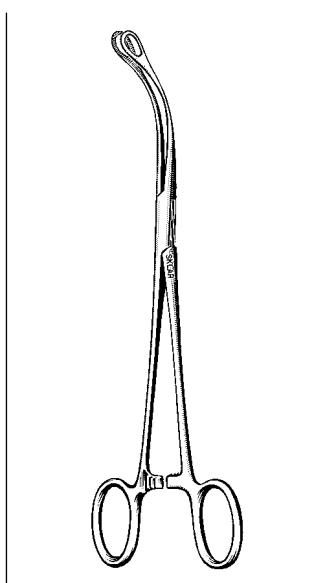
DELEE UTERINE FORCEPS

90-8111 11" Heavy



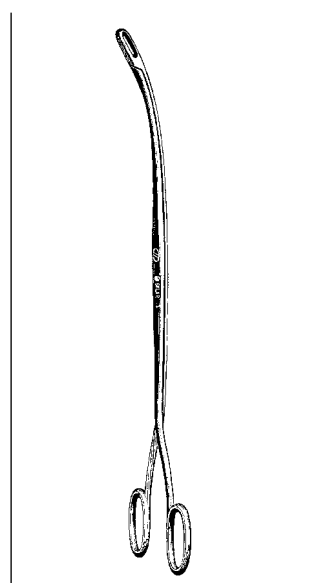
CLEMETSON FORCEPS

90-7895 9½" Straight



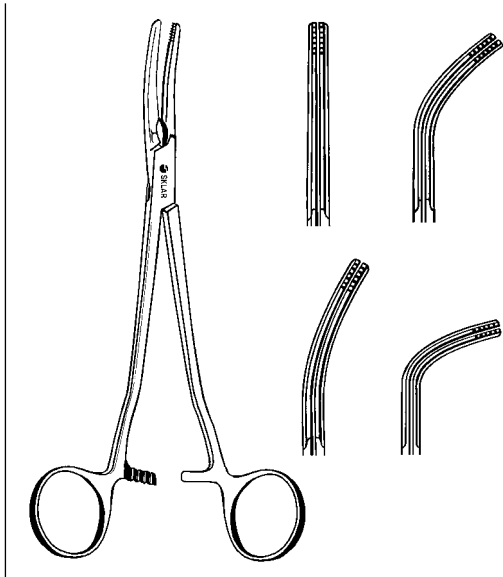
LAUFE UTERINE POLYP FORCEPS

90-7977 7¾" Curved



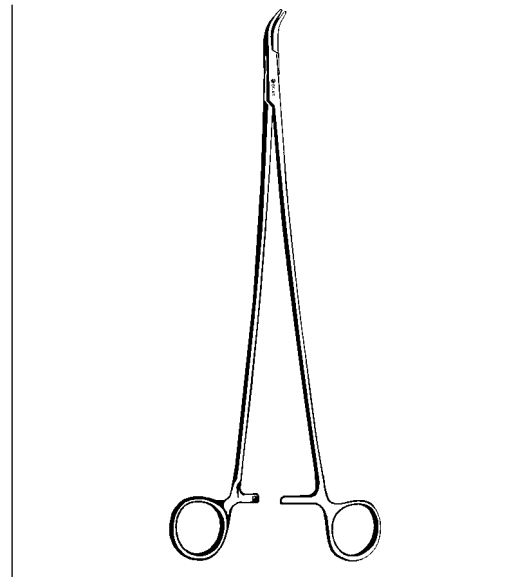
CAMPION FORCEPS

90-7898 9¼" Curved



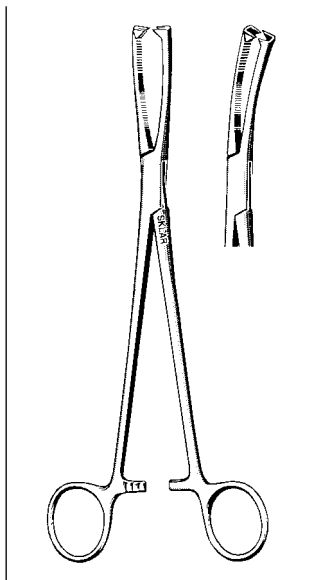
HYSTERECTOMY CLAMPS

- 90-2790 9½" Straight
- 90-2792 9½" Slightly Curved
- 90-2793 9½" Full Curved
- 90-2794 9½" Angular



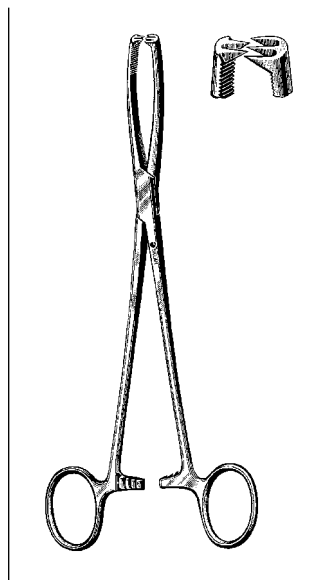
CLARK CLAMPS

- 90-2354 8¾"



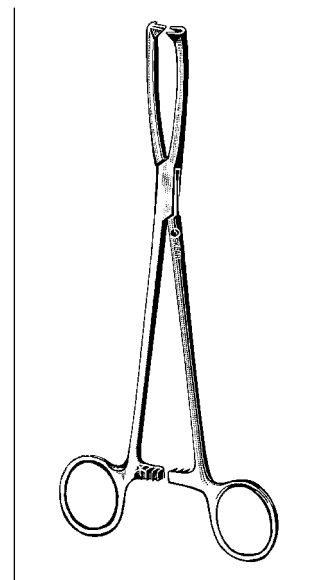
JACOBS VULSELLUM FORCEPS

- Serrated Jaws
- 91-2282 8¾" Straight
 - 91-2382 8¾" Angular



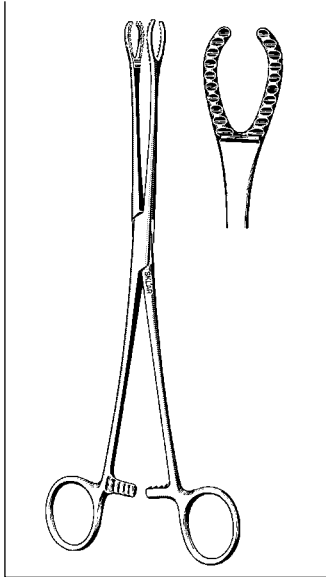
HENROTIN VULSELLUM FORCEPS

- 91-2585 8½" 2 x 3 Teeth



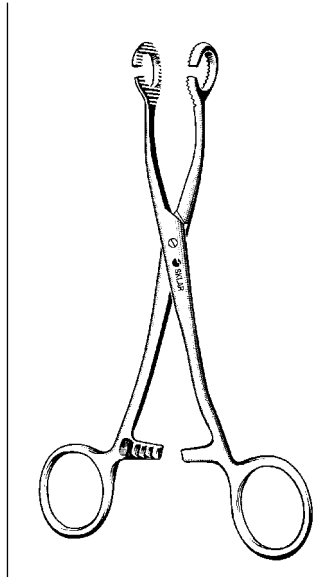
DOYEN VULSELLUM FORCEPS

- 91-2482 8¾" 2 x 2 teeth



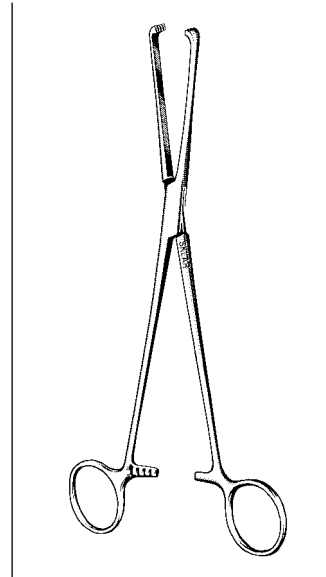
**GUTGLASS CERVIX
FORCEPS**

90-8090 9½"



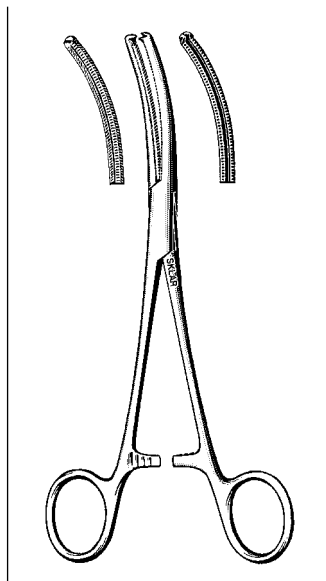
HILDEBRANDT FORCEPS

90-8065 6½"



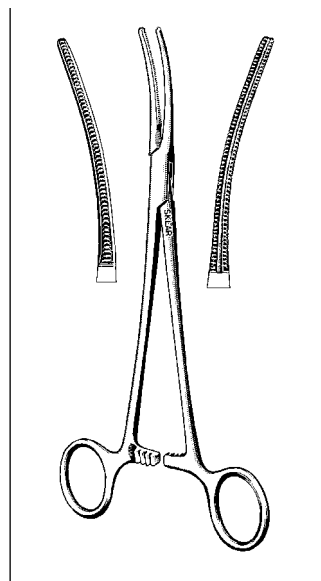
ALLIS FORCEPS

Atraumatic Jaws
36-2298 6" Straight
36-2385 10" Straight



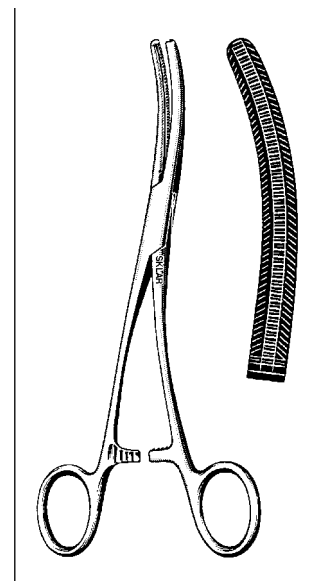
GELPI-LOWRIE FORCEPS

90-1885 8½"



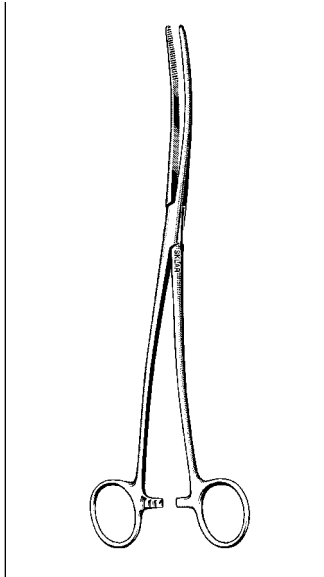
**GUSBERG
HYSTERECTOMY CLAMP**

90-2780 8" Curved



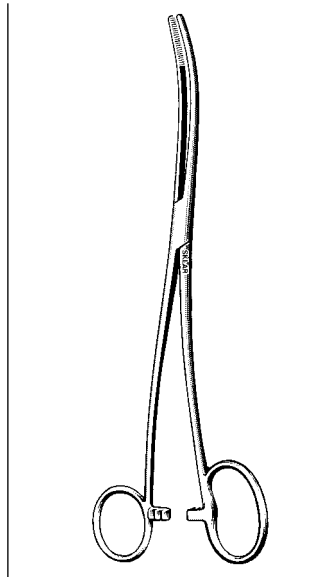
DE ALVAREZ

90-2782 8¼" Double Curve



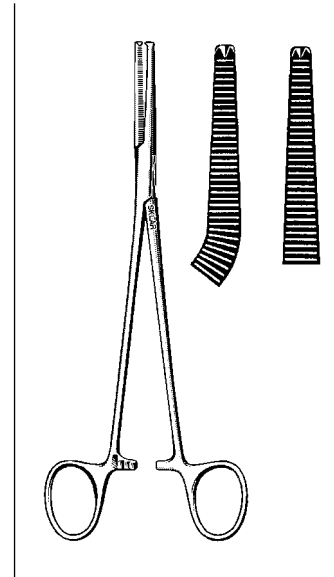
BOZEMAN FORCEPS

90-7610 10½" Straight
80-1410 10¼" Double Curve



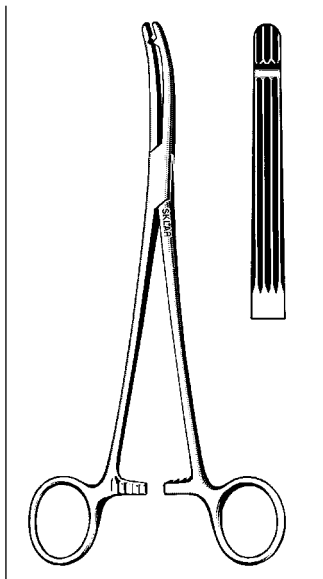
BOZEMAN FORCEPS

One large ring
90-7710 10¼" Double Curved



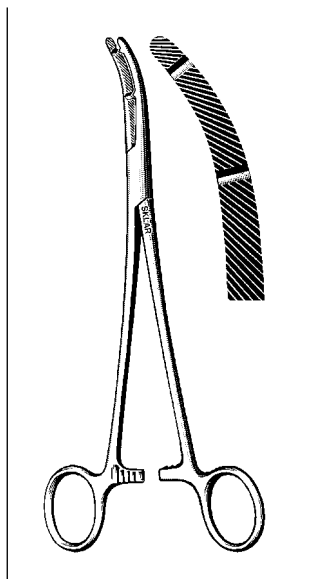
PHANEUF FORCEPS

90-2680 8¼" Angular
90-2682 8¼" Straight



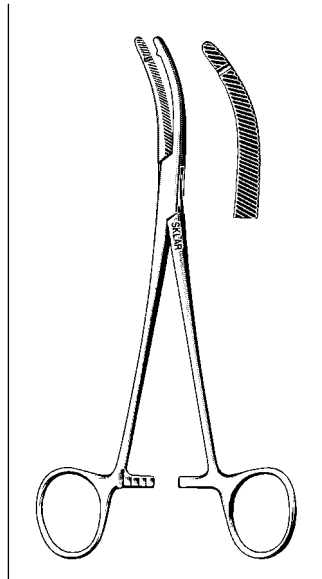
HEANEY-BALLENTINE FORCEPS

90-2480 8" Straight
90-2580 8" Curved



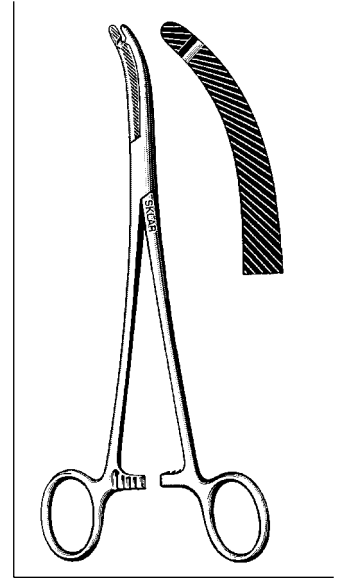
HEANEY FORCEPS

Heavy Double tooth
90-2280 8"
90-2387 8¾"



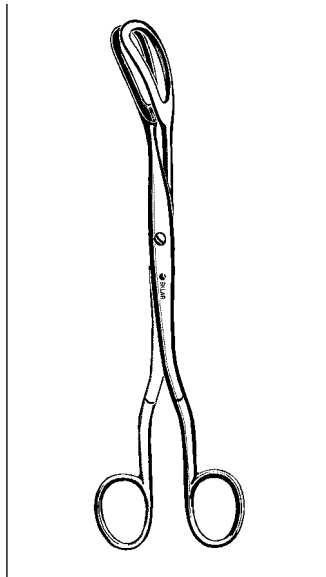
HEANEY FORCEPS

Single Tooth
90-1977 7¾" Light Model



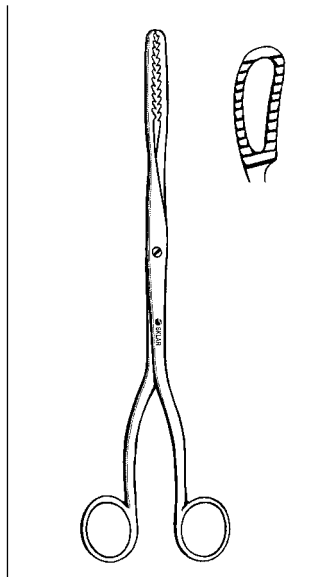
HEANEY FORCEPS

Single Tooth
90-2177 7¾" Heavy



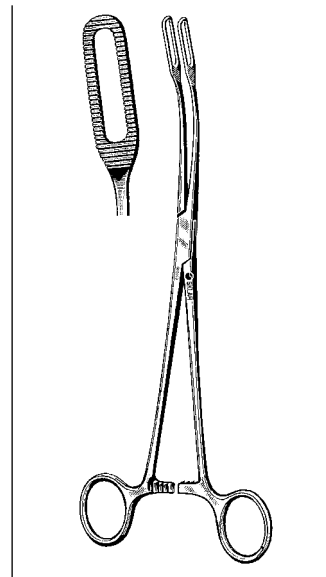
COREY OVUM FORCEPS

92-5295 9½"



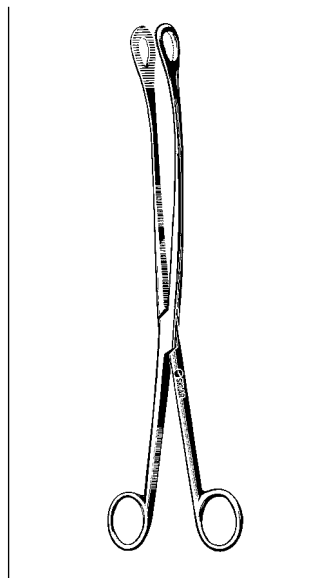
BIERER OVUM FORCEPS

91-3822 11" 16mm Serrated Jaw



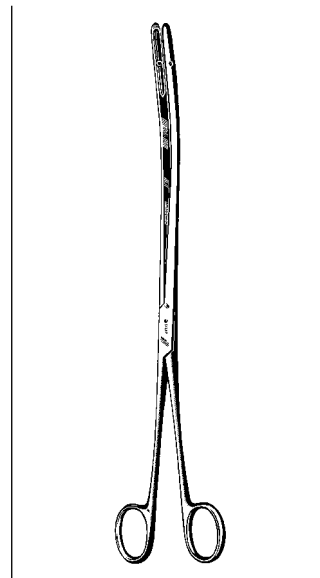
JAVERTS PLACENTA FORCEPS

92-5095 9½" Serrated
92-5195 9½" Smooth
(Long Island College)



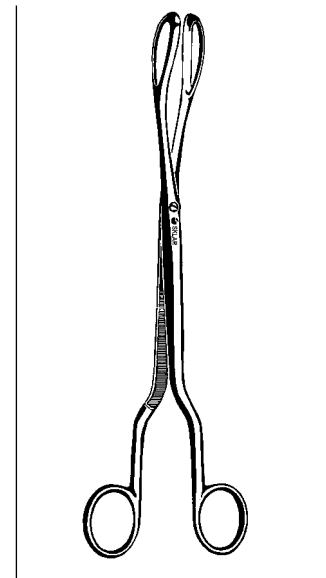
KELLY PLACENTA FORCEPS

Curved
92-5012 12"



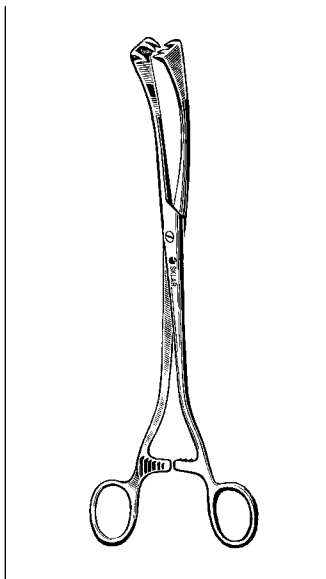
BOND PLACENTA FORCEPS

92-5412 12"



BARRETT PLACENTA FORCEPS

92-5310 10"



**SECOND (COLLIN)
FORCEPS**

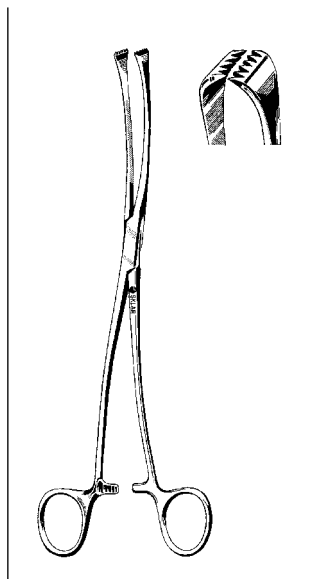
4 x 4 Teeth

91-3795 9½" Curved on flat

3 x 3 Teeth

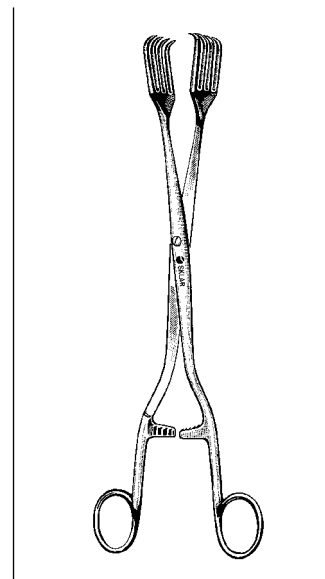
91-3095 9½" Straight

91-3195 9½" Curved sideways



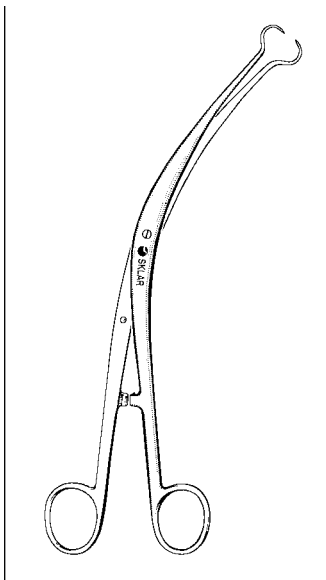
**IOWA MEMBRANE
FORCEPS**

91-4310 10"



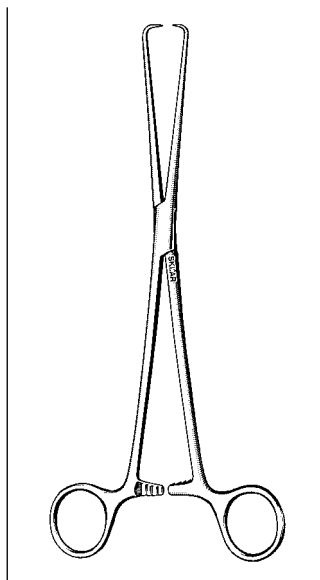
BILLROTH FORCEPS

91-3810 10¾" 4 x 4 Teeth



**GRAVES TENACULUM
FORCEPS**

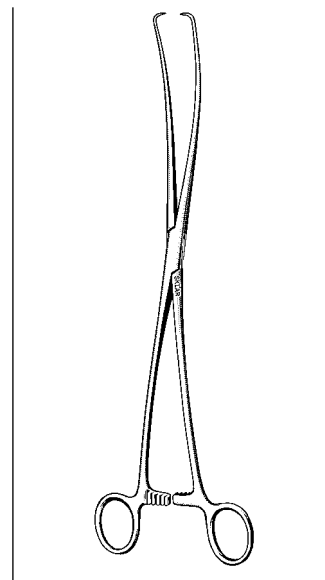
91-2598 9" Curved sideways



**SCHROEDER
TENACULUM FORCEPS**

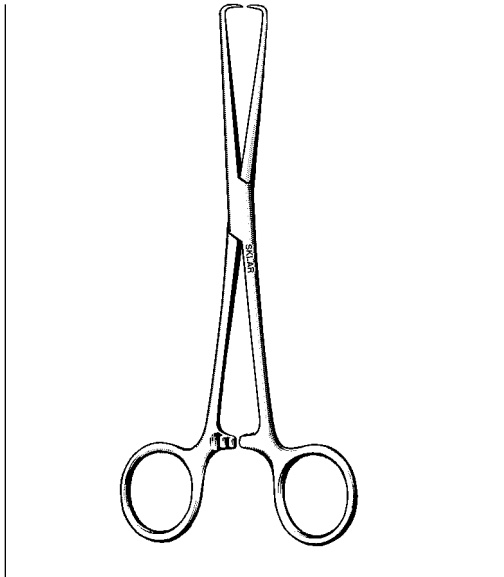
91-1290 9½"

91-1298 10¾" Pozzi



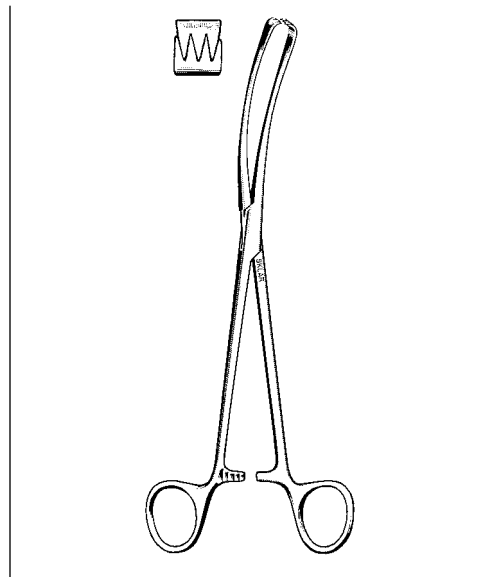
**DUPLAY TENACULUM
FORCEPS**

91-1111 11" S-Curve



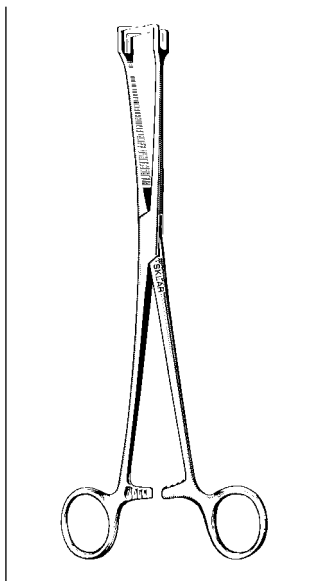
**BARRETT TENACULUM
FORCEPS**

91-1070 7"



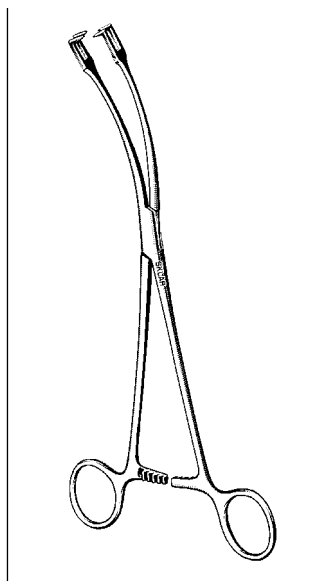
**TEALE VULSELLUM
FORCEPS**

Curved sideways
91-2695 9" 3 x 4 Teeth



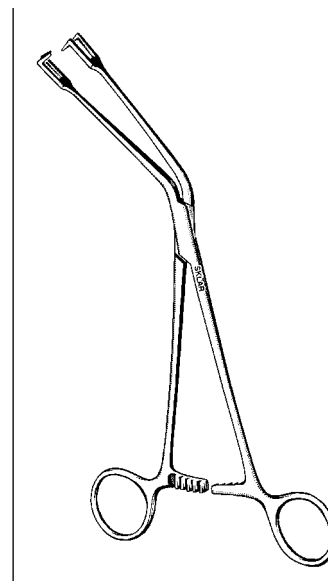
**SCHROEDER
VULSELLUM FORCEPS**

Straight
91-1590 9 1/2"



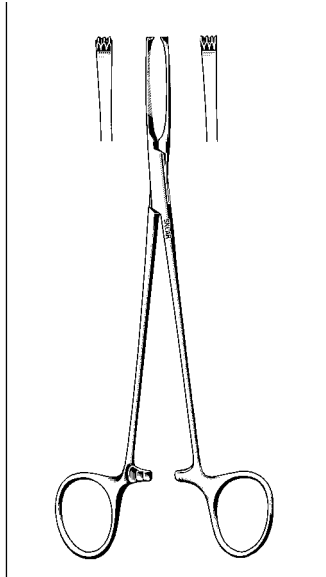
**SCHROEDER
VULSELLUM FORCEPS**

Curved sideways
91-1890 9 1/2"



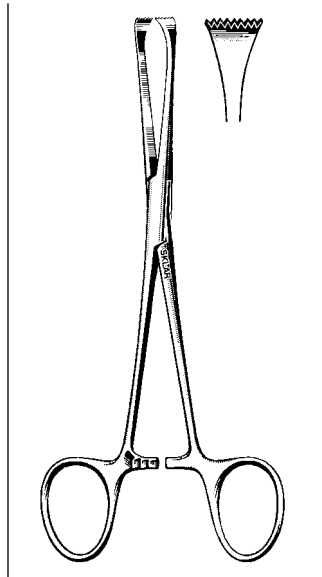
**SCHROEDER
VULSELLUM FORCEPS**

Angled sideways
91-1990 9"



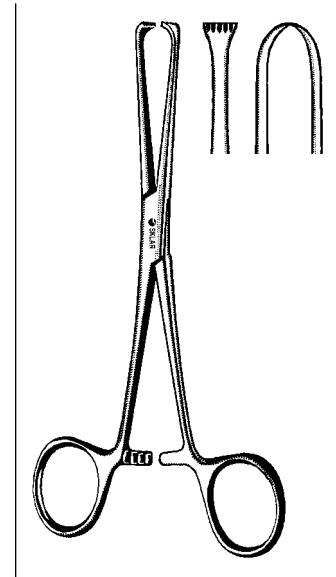
SKLAR-ALLIS FORCEPS

36-1960 6" (Judd)
36-1975 7½"



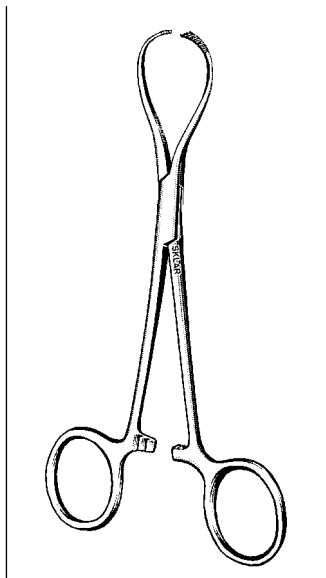
ALLIS-ADAIR FORCEPS

36-1765 6½" 9 x 10



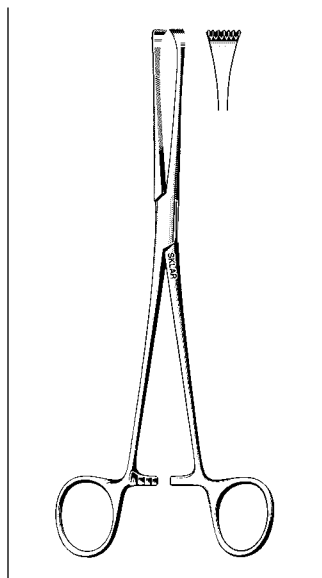
BOYS-ALLIS TISSUE FORCEPS

36-1860 6" 5 x 6 teeth
Heavy pattern



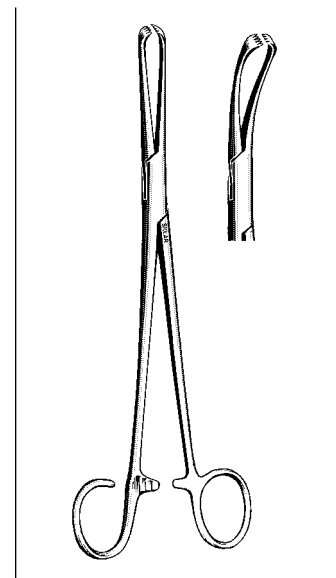
ABRAMSON-ALLIS FORCEPS

Small Jaw
91-1562 5½"



ALLIS-THOMS FORCEPS

36-2380 8" 6 x 7



COLVER-COAKLEY FORCEPS

74-2475 7½" Curved

Sklarlite™ Forceps Provide Lightness And Durability

Sklar has developed a new line of premium operating room forceps that offers the surgeon maximum control and precision. Our research determined a need for forceps that were a lighter pattern while maintaining the strength and durability of a standard pattern.

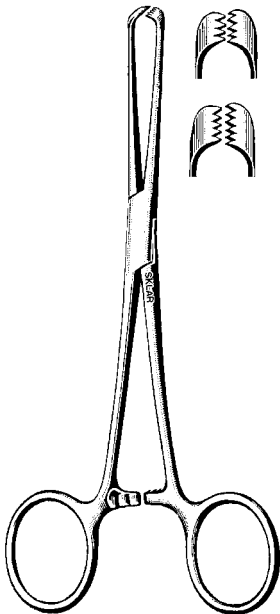
Sklar has recognized the need for a manufacturing technique that mills scant microns off our standard pattern while maintaining the structural integrity of the original instrument. The result is a noticeably lighter, extremely sensitive instrument that can withstand the daily rigors of surgery.

SKLARLITE™ forceps carry the same day-in and day-out reliability that you have come to expect from all Sklar instruments. Sklar has applied its more than 100 years of experience in developing this superior instrument.

SKLARLITE™ forceps are covered under the same warranty that guarantees all Sklar instruments for a lifetime of dependable use.



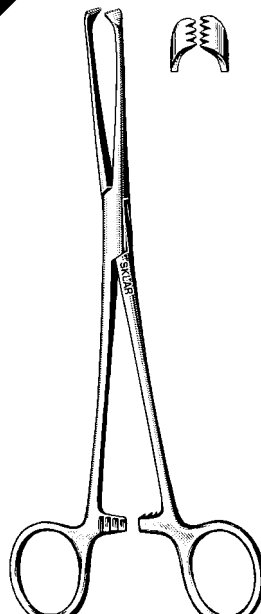
Sklar Exclusive!



**ALLIS TISSUE
FORCEPS**

36-2060	6"	3X4
36-2160	6"	4X5
36-2260	6"	5X6
36-2275	7½"	5X6
36-2295	9½"	5X6

NEW!



**SKLARLITE
ALLIS TISSUE
FORCEPS**

23-2851	6"	4X5
23-2852	6"	5X6

SKLARLITE
THE LIGHT TOUCH

Skarlite XD™ Are The Lightest Pattern General OR Forceps Available

Sklar Instruments has surpassed industry standards by developing a delicate pattern operating room forceps offering the surgeon one of the lightest general surgery forceps on the market today. For the surgeon who demands the finest in OR forceps, *Sklar is the choice.*

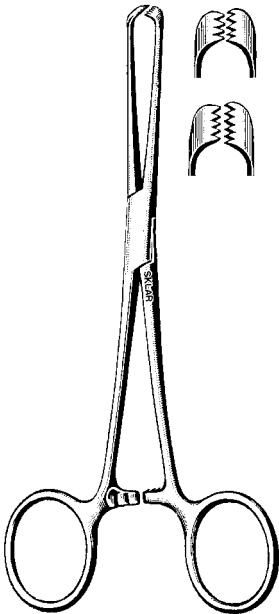
Sklar employs the same manufacturing process used in making the SKLARLITE™ forceps and mills scant microns off our delicate pattern while maintaining its structural integrity. The result is the most delicate and sensitive forceps available today.

SKLARLITE XD™ forceps carry the same day-in and day-out reliability that you have come to expect from all Sklar instruments. Sklar has applied its more than 100 years of experience in developing this superior instrument.

SKLARLITE XD™ forceps are covered under the same warranty that guarantees all Sklar instruments for a lifetime of dependable use.



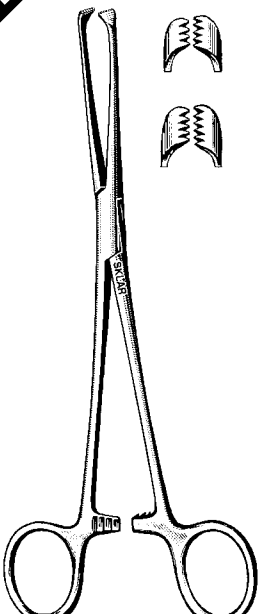
Sklar Exclusive!



**ALLIS TISSUE
FORCEPS
DELICATE**

18-2140	4"	4X5
18-2155	5"	4X5
22-6157	5½"	4X5
18-2162	6"	4X5
18-2164	6"	5X6

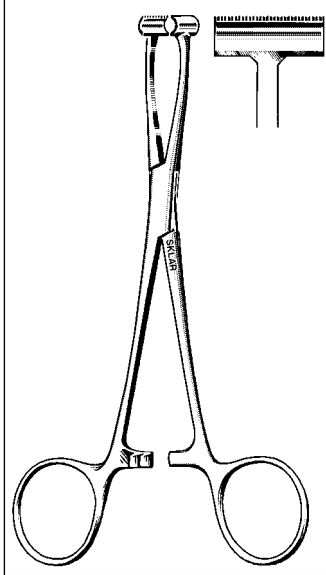
NEW!



**SKLARLITE EXTRA
DELICATE
ALLIS TISSUE
FORCEPS**

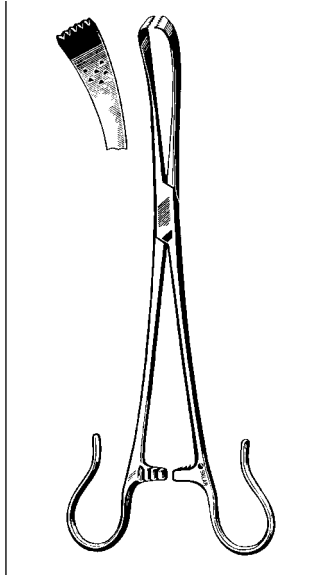
23-2861	5"	4X5
23-2862	5½"	4X5
23-2864	6"	4X5
23-2865	6"	5X6

SKLARLITE XD
EXTRA ◊ DELICATE



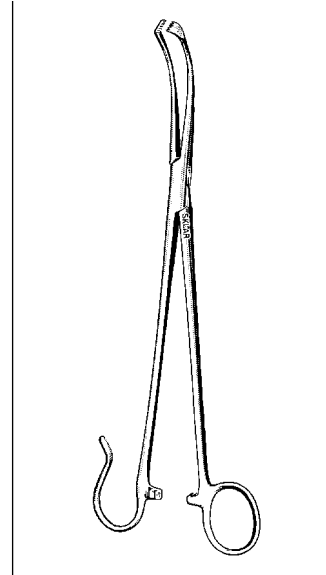
PRATT FORCEPS

T-Shape
17-1055 6"



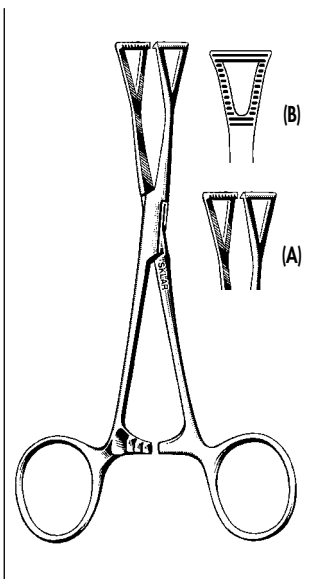
CRAIG FORCEPS

74-1280 8" 2 open rings



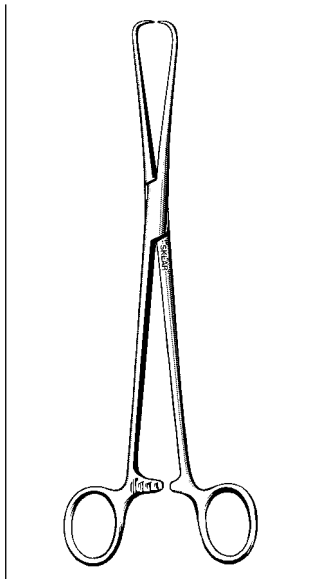
WHITE FORCEPS

Open Ring
74-2575 7½" Curved
74-2590 9" Curved



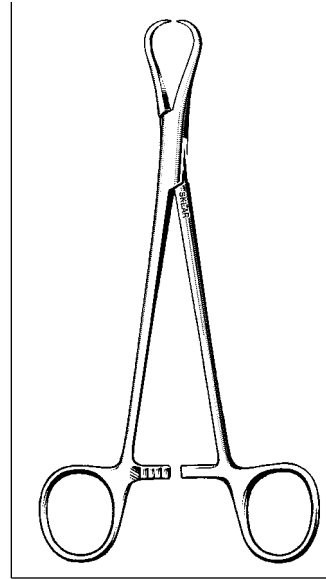
COLLINS FORCEPS

22-6162 6¼" A-Style ½" Jaw
36-2577 8" A-Style 1" Jaw
36-2595 9½" A-Style 1" Jaw
17-2957 5½" B-Style Pennington ½" Jaw
17-2958 8" B-Style Pennington ½" Jaw



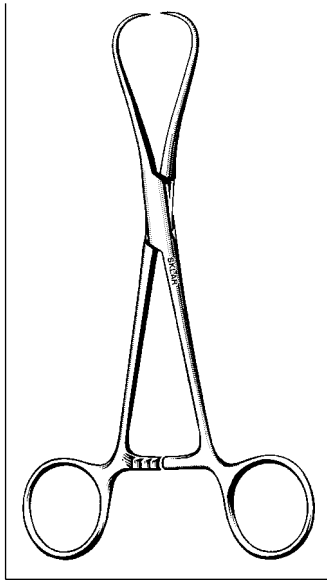
TENACULUM FORCEPS

18-2257 5¾" Delicate
91-1070 7" Barrett
91-1290 9½" Schroeder



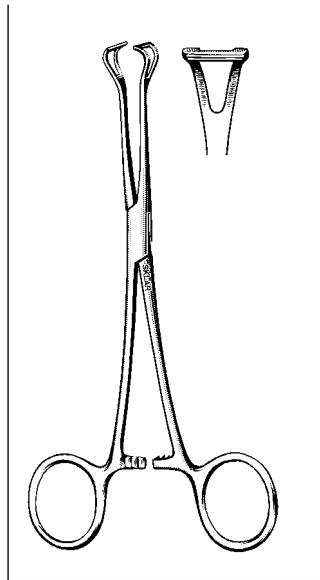
ADAIR BREAST TENACULUM FORCEPS

36-1865 6½"



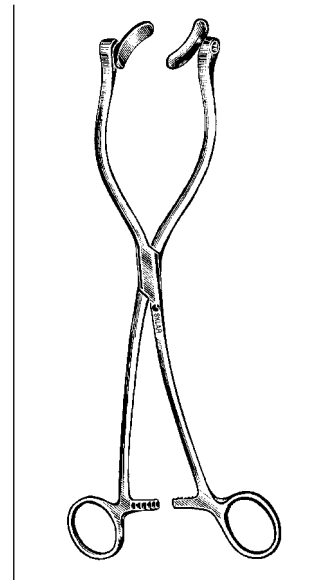
**STAUDE TENACULUM
FORCEPS**

91-1455 5½"
Staude-Moore
91-1465 6½"



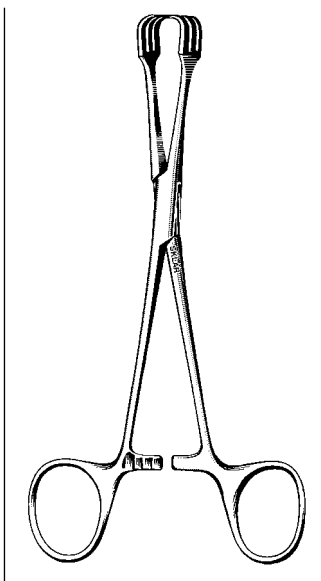
BABCOCK FORCEPS

22-6155 5½"
36-1662 6¼"
36-1677 8"
36-1692 9½"



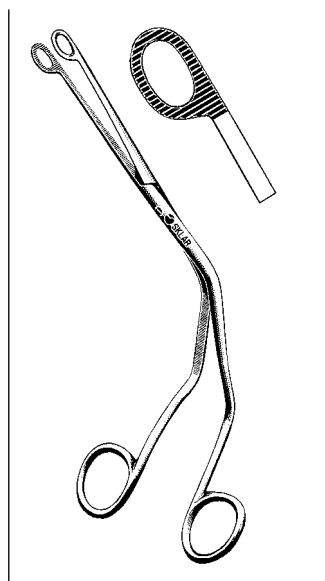
**BUXTON UTERINE
CLAMP**

Swivel jaws
91-4010 10"



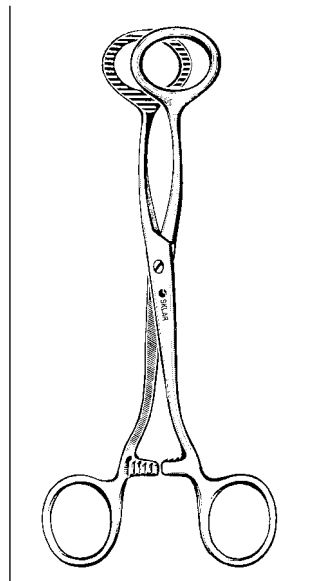
**LAHEY TRACTION
FORCEPS**

17-3562 6¼"
91-2080 8" (MGH)



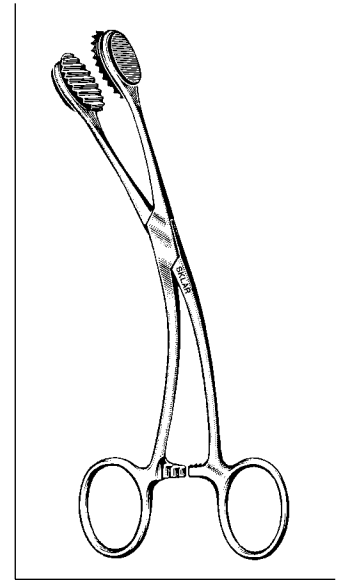
**MAGILL CATHETER
FORCEPS**

07-1777 Infant 6½"
07-1780 Child 8"
07-1797 Adult 10"



**COLLINS TONGUE
SEIZING FORCEPS**

07-1565 6½"
07-1570 7"



**YOUNG TONGUE
SEIZING FORCEPS**

07-1562 6¼"
07-1563 Jaw inserts only



Skларlite™ Forceps Provide Lightness And Durability

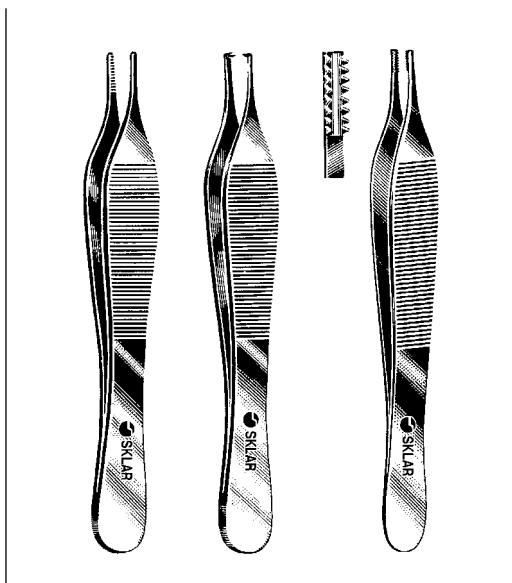
SKLARLITE
THE LIGHT TOUCH

Skлар has developed a new line of premium operating room forceps that offers the surgeon maximum control and precision. Our research determined a need for forceps that was a lighter pattern while maintaining the strength and durability of a standard pattern.

Skлар has recognized the need for a manufacturing technique that mills scant microns off our standard pattern while maintaining the structural integrity of the original instrument. The result is a noticeably lighter, extremely sensitive instrument that can withstand the daily rigors of surgery.

SKLARLITE™ forceps carry the same day-in and day-out reliability that you have come to expect from all Skлар instruments. Skлар has applied its more than 100 years of experience in developing this superior instrument.

SKLARLITE™ forceps are covered under the same warranty that guarantees all Skлар instruments for a lifetime of dependable use.



ADSON FORCEPS

- Dressing
50-3147 4¾" Serrated
- Tissue
50-3047 4¾" 1X2
- Adson-Brown
47-1447 4¾" Side Grasping



**SKLARLITE
ADSON FORCEPS**

- Dressing
23-2600 4¾" Serrated
- Tissue
23-2602 4¾" 1X2
- Adson-Brown
23-2603 4¾" Side Grasping

Sklarlite XD™ Are The Lightest Pattern General OR Forceps Available

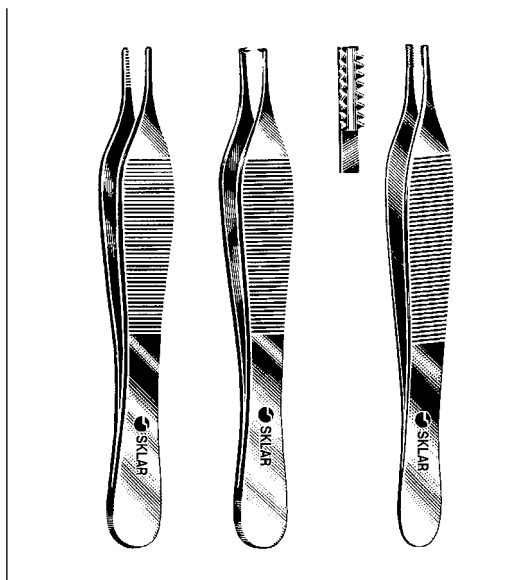
SKLARLITE XD
EXTRA ◊ DELICATE

Sklar Instruments has surpassed industry standards by developing a delicate pattern operating room forceps that offers the surgeon one of the lightest general surgery forceps on the market today. For the surgeon who demands the finest in OR forceps, *Sklar is the choice.*

Sklar employs the same manufacturing process used in making the SKLARLITE™ forceps and mills scant microns off our delicate pattern while maintaining its structural integrity. The result is the most delicate and sensitive forceps available today.

SKLARLITE XD™ forceps carry the same day-in and day-out reliability that you have come to expect from all Sklar instruments. Sklar has applied its more than 100 years of experience in developing this superior instrument.

SKLARLITE XD™ forceps are covered under the same warranty that guarantees all Sklar instruments for a lifetime of dependable use.



**ADSON FORCEPS
DELICATE**

Dressing
47-2147 4¾" Serrated

Tissue
47-2047 4¾" 1X2
47-2049 4¾" 2X3

Adson-Brown
47-2447 4¾" Side Grasping

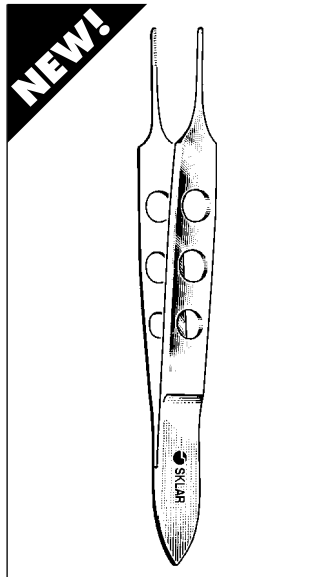


**SKLARLITE EXTRA DELICATE
ADSON FORCEPS**

Straight
23-2604 4¾" Serrated

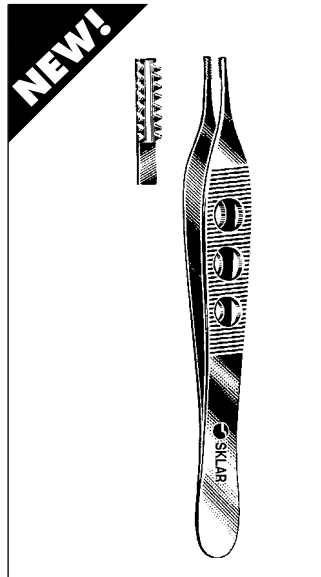
Tissue
23-2606 4¾" 1X2

Adson-Brown
23-2608 4¾" Side Grasping



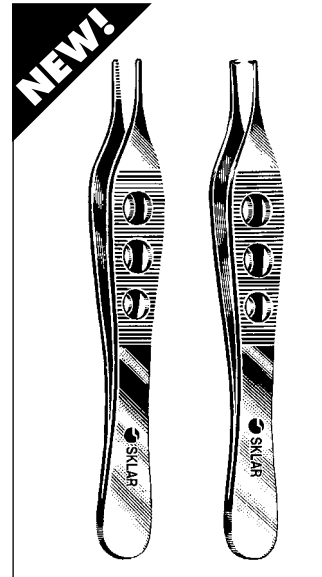
**SKLAR LITEGRIP™
BISHOP-HARMON
FORCEPS**

66-4034 3½" Serrated
66-4134 3½" 1 x 2 Teeth



**SKLAR LITEGRIP™
ADSON-BROWN
FORCEPS**

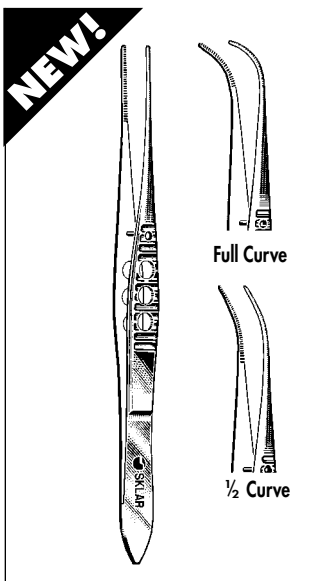
47-1448 4¾" Side Grasping



**SKLAR LITEGRIP™ ADSON
FORCEPS**

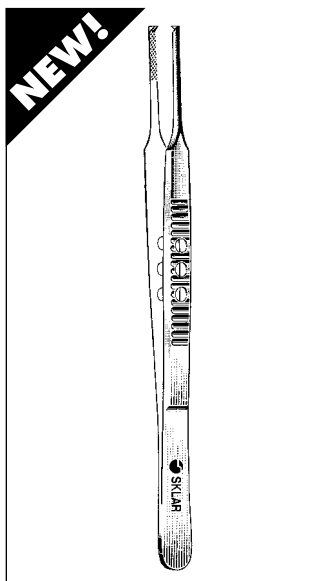
50-3148 Serrated 4¾"
50-3050 1 x 2 Teeth 4¾"

LiteGrip™ Fenestrated Handles For Firm Secure Grip



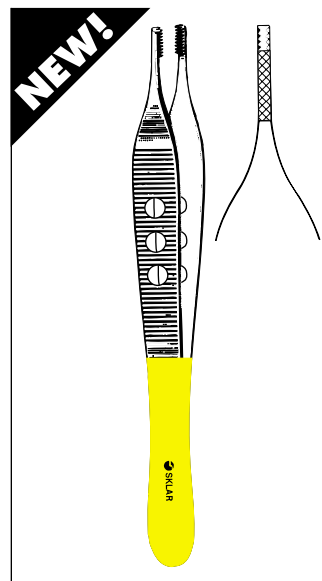
**SKLAR LITEGRIP™
IRIS FORCEPS**

Serrated
66-2742 4" Straight
66-2942 4" ½ Curved
66-3142 4" Full Curve



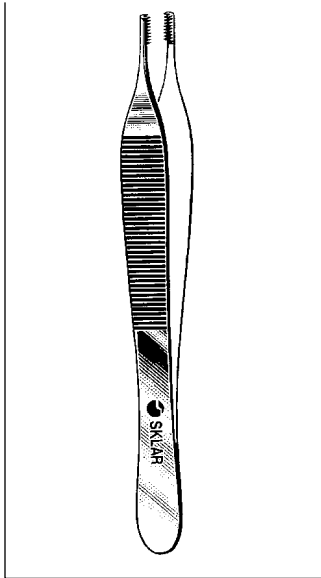
**SKLAR LITEGRIP™
IRIS FORCEPS**

1 x 2 Teeth
66-3342 4" Straight
66-3542 4" ½ Curved
66-3742 4" Full Curve



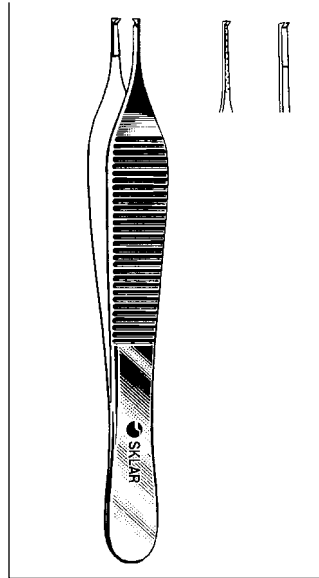
**SKLAR LITEGRIP™ T-C
ADSON-BROWN TISSUE
AND SUTURE FORCEPS**

51-1448 4¾" Side Grasping with
Tungsten Carbide
insert 4¾"



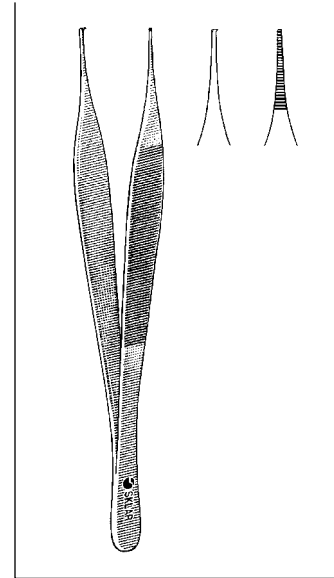
**ADSON-BROWN
FORCEPS**

47-1447 4³/₄" 9 x 9 Teeth



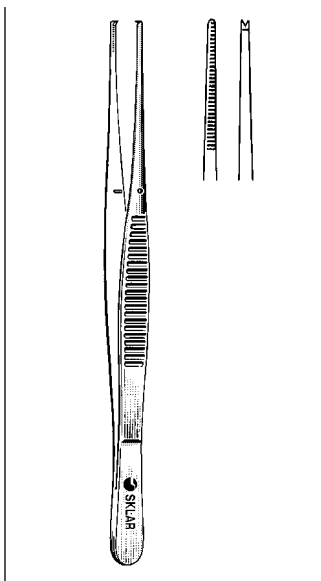
ADSON FORCEPS

50-3048 4³/₄" Serrated, 1 x 2
50-3049 4³/₄" 1 x 2 w/Platform



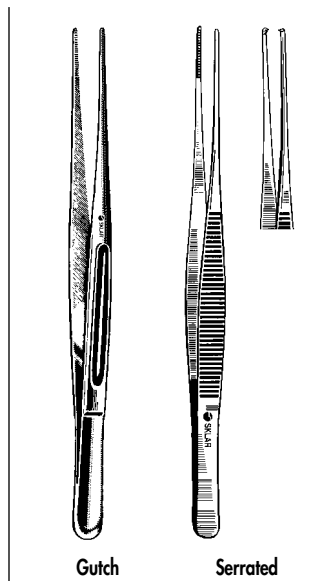
**MICRO ADSON
FORCEPS**

98-2047 4³/₄" 1 x 2 Teeth
98-2048 4³/₄" Serrated



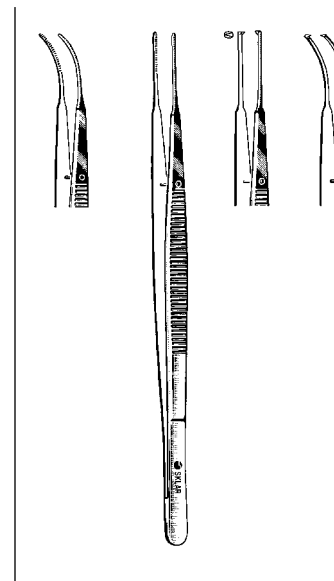
**CUSHING FORCEPS
DELICATE**

22-6770 7" Serrated
22-6870 7" 1 x 2



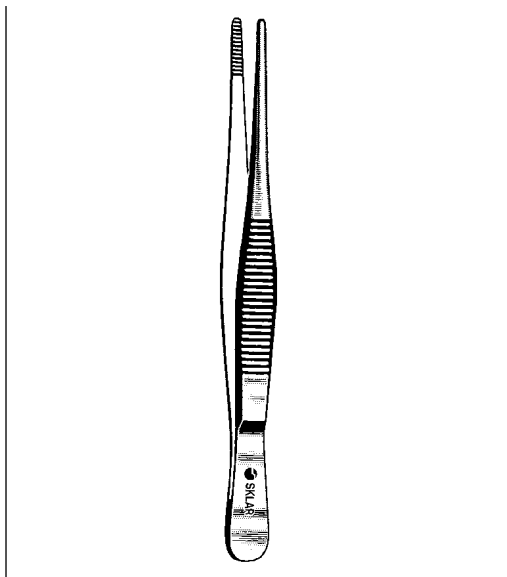
CUSHING BRAIN DELICATE

50-2670 7" Serrated Gutch Handle
50-2770 7" Serrated Serrated Handle
50-2870 7" 1 x 2 Gutch Handle
50-2970 7" 1 x 2 Serrated Handle



GERALD FORCEPS

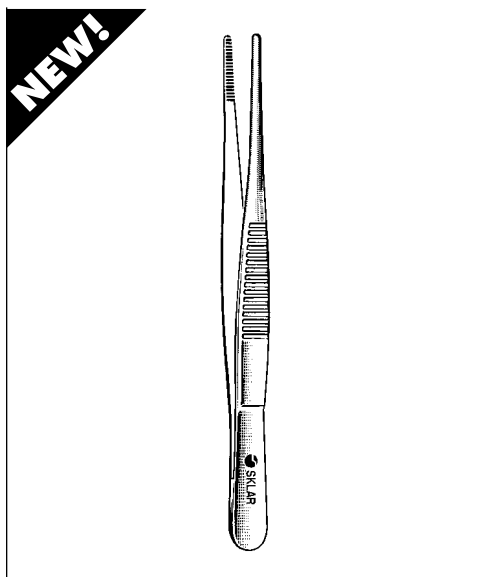
Serrated
47-1180 7" Straight
47-1175 7" Curved
1 x 2
47-1173 7" Straight
47-1186 7" Curved



DRESSING FORCEPS

Serrated

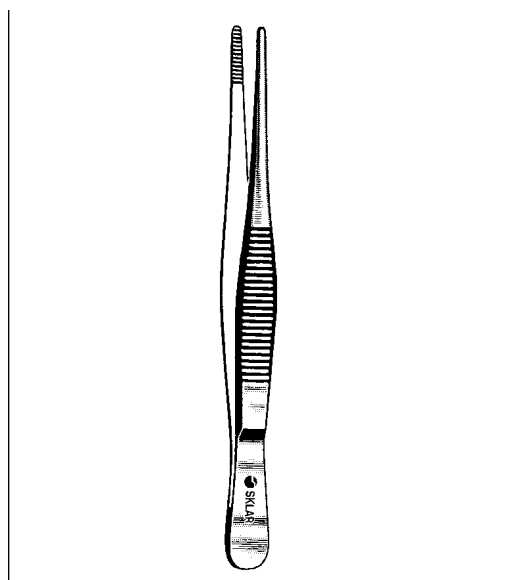
19-1045	4½"	19-1080	8"
19-1050	5"	19-1110	10"
19-1055	5½"	19-1112	12"
19-1060	6"		



SKLARLITE DRESSING FORCEPS

Serrated

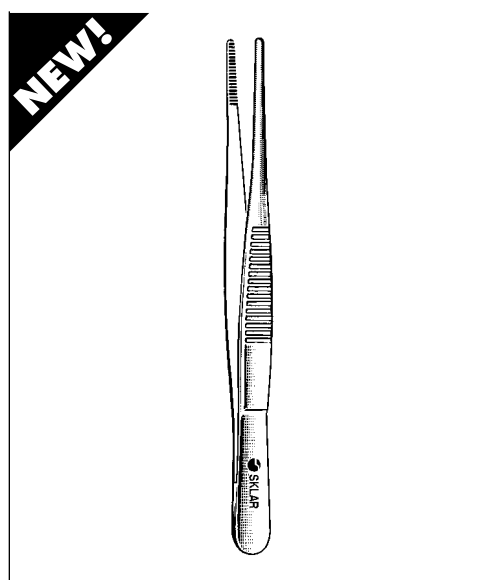
23-2824	4½"	23-2828	5½"
23-2826	5"	23-2830	6"



DRESSING FORCEPS DELICATE

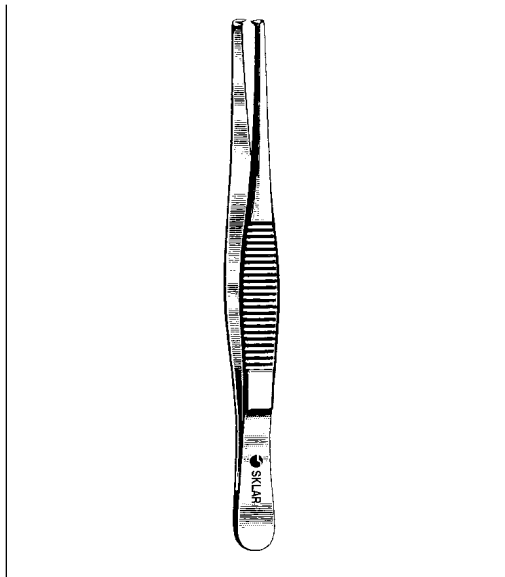
Serrated

22-1161	4½"	22-1163	5½"
22-1162	5"	22-1164	6"



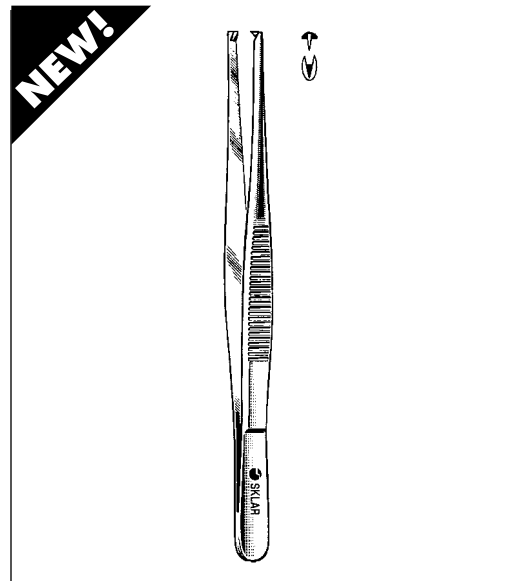
SKLARLITE EXTRA DELICATE DRESSING FORCEPS

23-2834	4½"	23-2838	5½"
23-2836	5"		



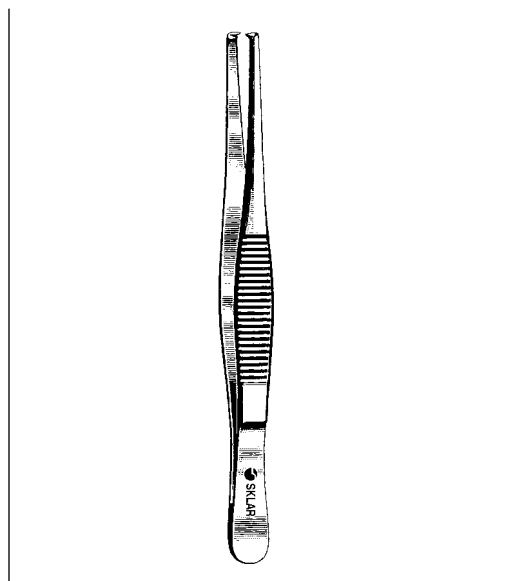
TISSUE FORCEPS

- | | | |
|-------------|-----|-------------|
| 1 x 2 teeth | | |
| 19-1245 | 4½" | 19-1280 8" |
| 19-1250 | 5" | 19-1310 10" |
| 19-1255 | 5½" | 19-1312 12" |
| 19-1260 | 6" | |



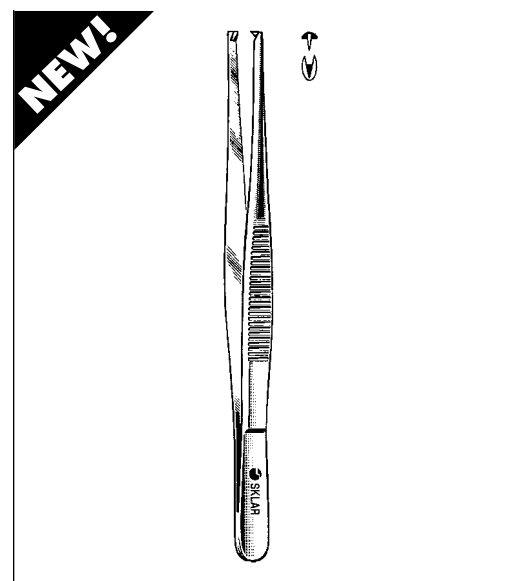
SKLARLITE TISSUE FORCEPS

- | |
|-------------|
| 1 x 2 teeth |
| 23-2811 5½" |



TISSUE FORCEPS DELICATE

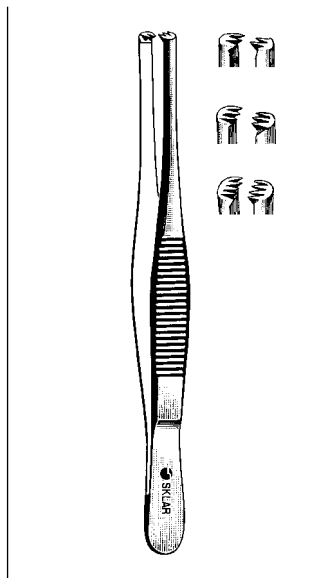
- | |
|-------------|
| 1 x 2 teeth |
| 22-1063 5½" |



SKLARLITE EXTRA DELICATE TISSUE FORCEPS

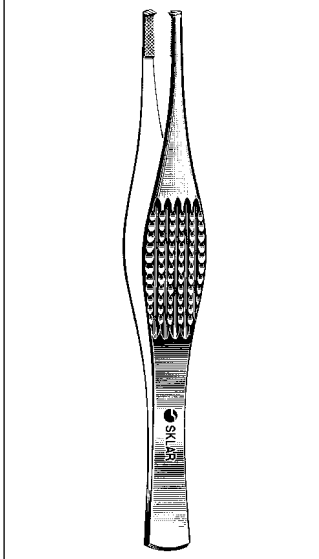
- | |
|-------------|
| 1 x 2 teeth |
| 23-2819 5½" |

FORCEPS



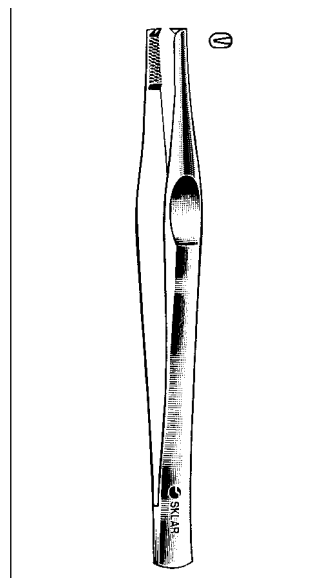
TISSUE FORCEPS

2 x 3		3 x 4	
19-1450	5"	19-1655	5½"
19-1455	5½"	19-1660	6"
19-1460	6"		
19-1480	8"	4 x 5	
19-1510	10"	19-1855	5½"
19-1512	12"	19-1910	10"



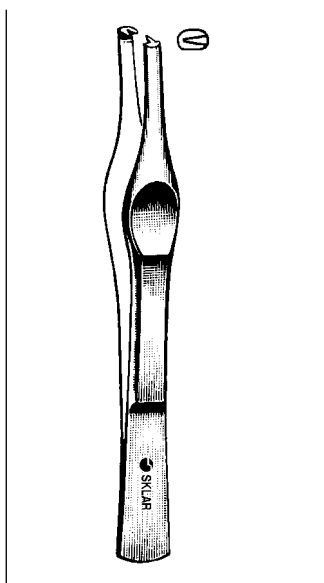
FERRIS-SMITH FORCEPS

47-1470 7" 1 x 2



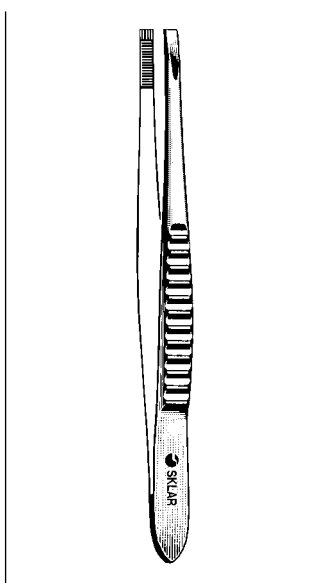
LANE TISSUE FORCEPS

Straight
 19-1955 5½" 1 x 2
 19-1975 7½" 1 x 2



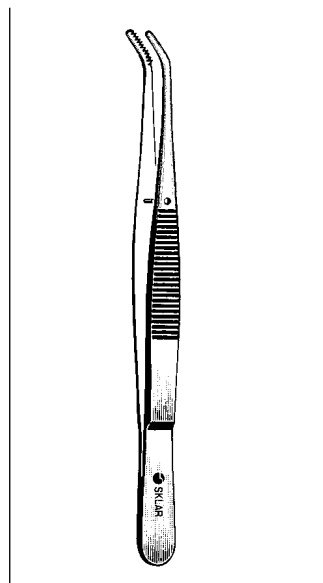
MICHEL TISSUE FORCEPS

Straight
 19-1950 5" 1 x 2



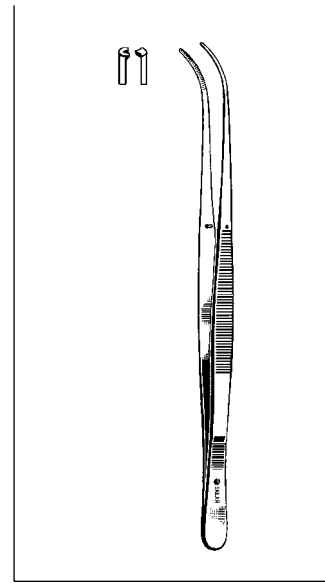
STILLE TISSUE FORCEPS

19-2050 5" 4 x 5



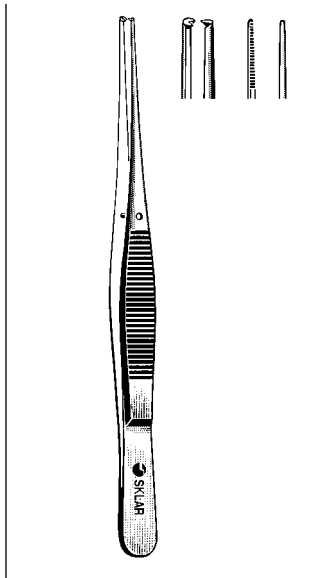
ESSRIG TISSUE FORCEPS

19-2460 6" Angular



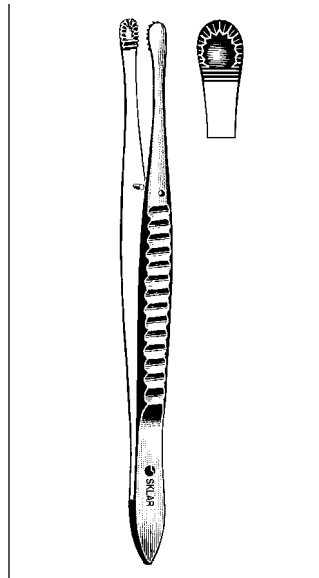
TISSUE FORCEPS

1X2 Teeth
 52-3597 9¾" Curved



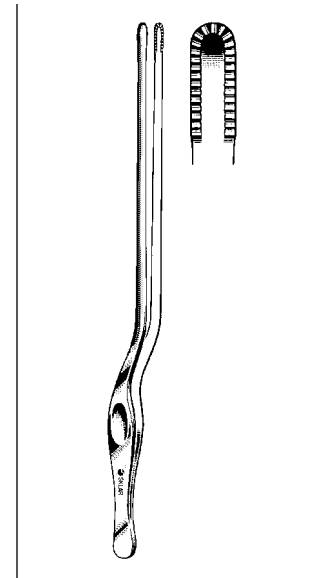
SEMKIN DRESSING FORCEPS

- 22-4150 5" Narrow Serrated
- 22-4250 5" Delicate Serrated
- 22-4350 5" Narrow 1 x 2
- 22-4450 5" Delicate 1 x 2
- 22-4550 5" Narrow 2 x 3
- 22-4650 5" Delicate 2 x 3



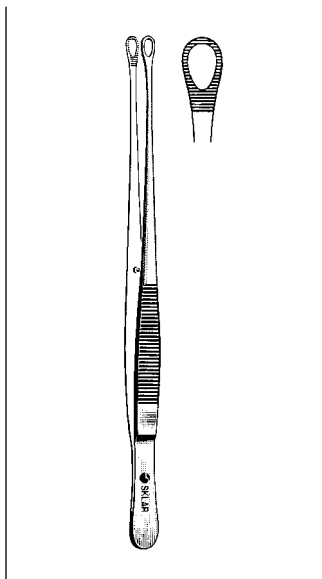
RUSSIAN TISSUE FORCEPS

- 19-2260 6"
- 19-2280 8"
- 19-2310 10"



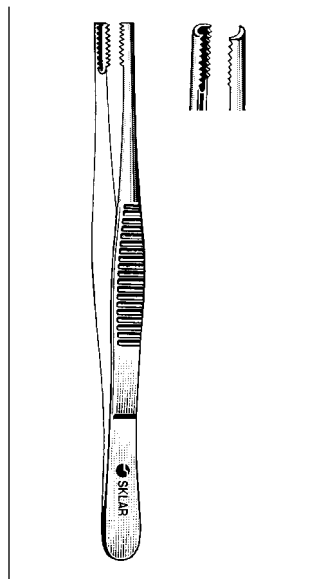
HARRINGTON-MAYO BAYONET FORCEPS

- 55-4114 14"



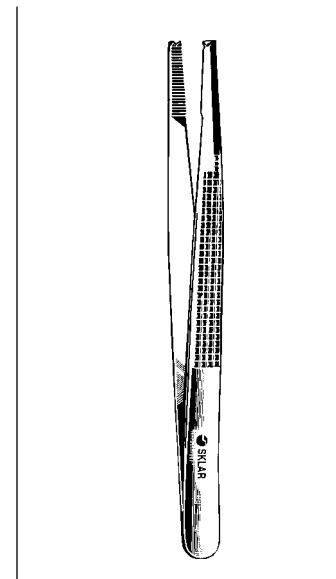
TUTTLE/SINGLEY FORCEPS

- 22-7470 7" Tuttle
- 36-1290 9" Singley



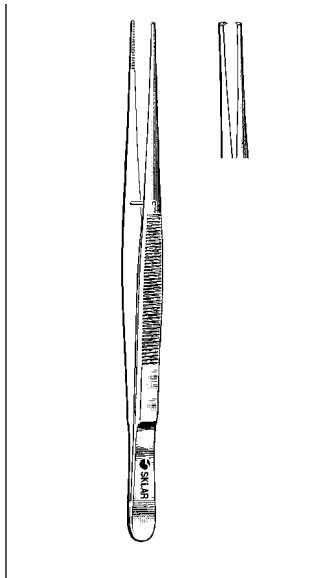
BROWN TISSUE FORCEPS

- Side Grasping
- 19-2860 6"
- 19-2880 8"
- 19-2910 10"



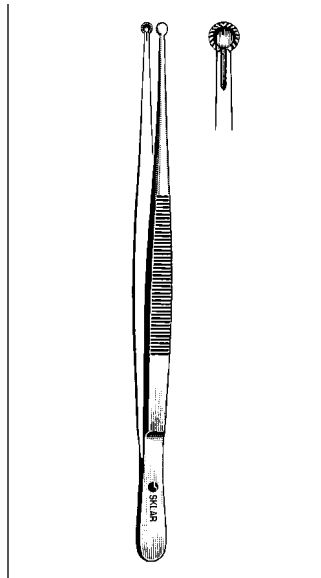
BONNEY TISSUE FORCEPS

- 19-2170 1 x 2 7"



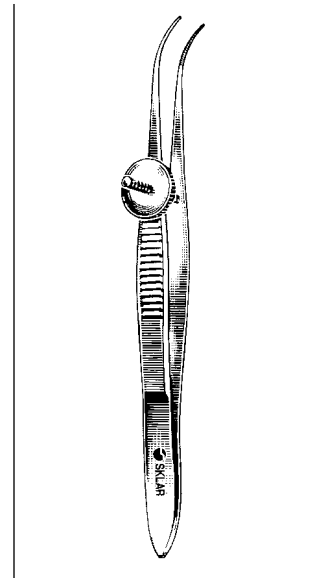
POTTS-SMITH FORCEPS

52-3270	7"	Serrated
52-3282	8 1/4"	Serrated
52-3370	7"	1 x 2
52-3382	8 1/4"	1 x 2
52-3310	10"	Serrated
52-3410	10"	1 x 2



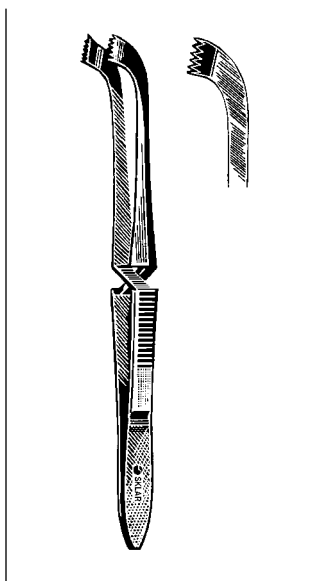
SKLAR NON-SLIP TISSUE FORCEPS

52-4260	6"	(Selman)
52-4310	10"	



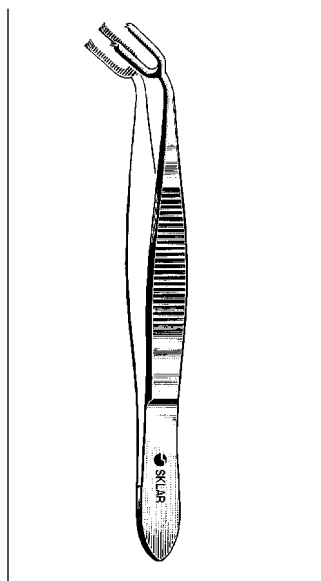
GORDON CATHETER FORCEPS

52-3240	4"
---------	----



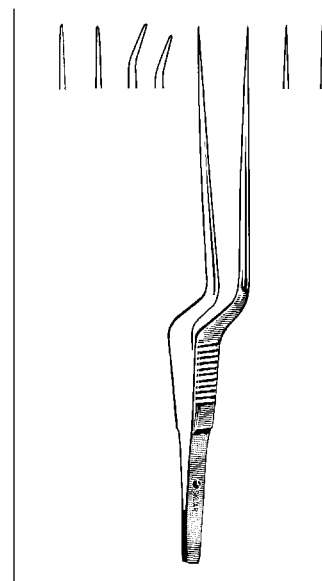
JAMES FORCEPS

19-2925	5"	Cross Action
---------	----	--------------



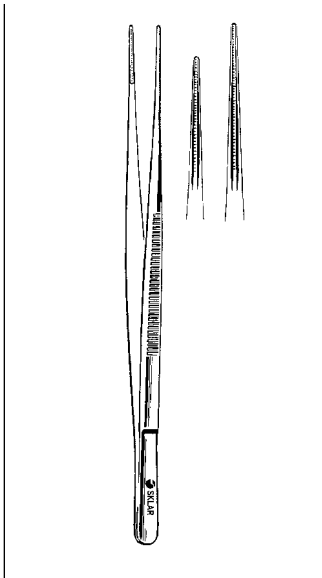
KING FORCEPS

19-2926	5 1/2"	Angular Tips
---------	--------	--------------



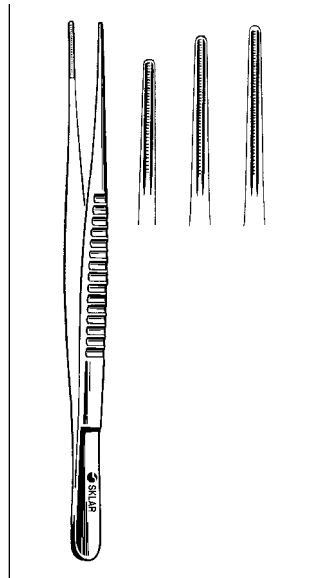
JACOBSON MICRO

98-2072	6 1/4"	Sharp
98-2075	7 1/4"	Blunt
98-2076	7 1/4"	Sharp
Angled Tip		
98-2077	7 1/4"	Blunt



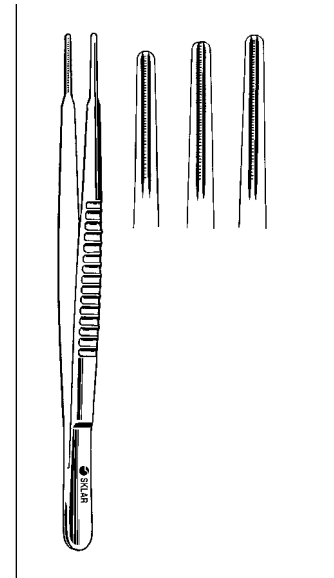
**DEBAKEY ATRAUMATIC
TISSUE FORCEPS**

1.5 mm jaws
 52-5062 6 1/4"
 52-5077 7 1/4"
 52-5095 9 1/2"



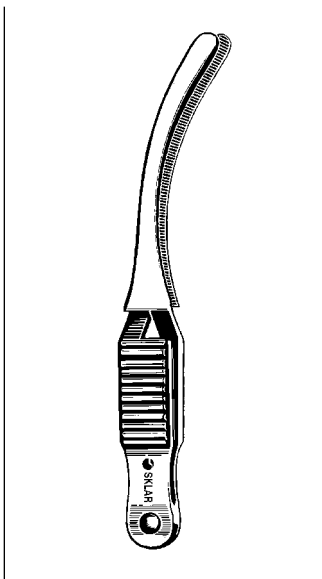
**DEBAKEY ATRAUMATIC
TISSUE FORCEPS**

2.0 mm jaws
 52-5162 6 1/4"
 52-5177 7 1/4"
 52-5195 9 1/2"



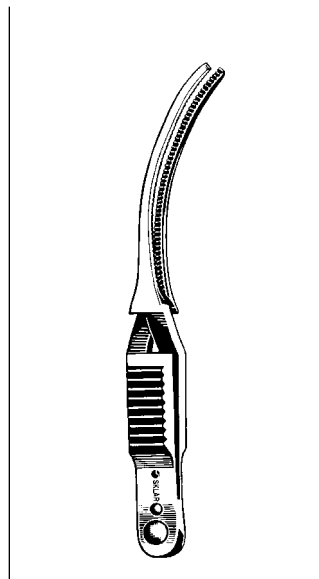
**DEBAKEY ATRAUMATIC
TISSUE FORCEPS**

3.5 mm jaws
 52-5262 6 1/4"
 52-5277 7 1/4"
 52-5295 9 1/2"



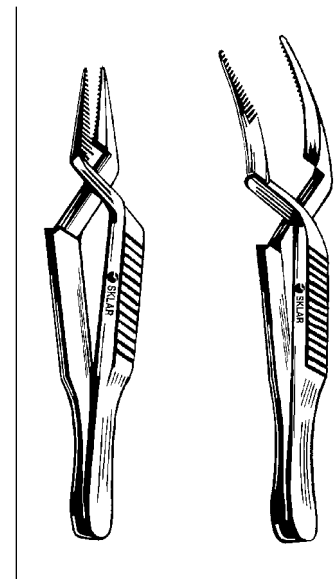
**JOHNS HOPKINS
BULLDOG CLAMP**

52-1415 1 1/2" 3.5 cm
 52-1417 1 3/4" 4.4 cm
 52-1420 2" 5.0 cm
 52-1422 2 1/4" 5.5 cm
 52-1430 3" 7.5 cm
 52-1435 3 1/2" 9.0 cm



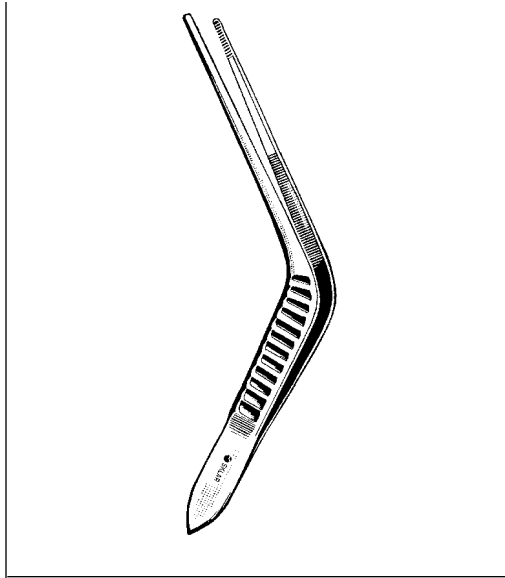
DEBAKEY BULLDOG CLAMP

Straight Cross Action Straight
 52-1530 3" 7.5 cm
 52-1531 3 1/2" 8.5 cm
 52-1532 4 1/4" 10.5 cm
 52-1533 4 3/4" 12.0 cm
 Straight Cross Action Curved
 52-1540 2 3/4" 7.0 cm
 52-1541 3 1/4" 8.0 cm
 52-1542 4" 10.0 cm
 52-1543 4 3/4" 11.5 cm



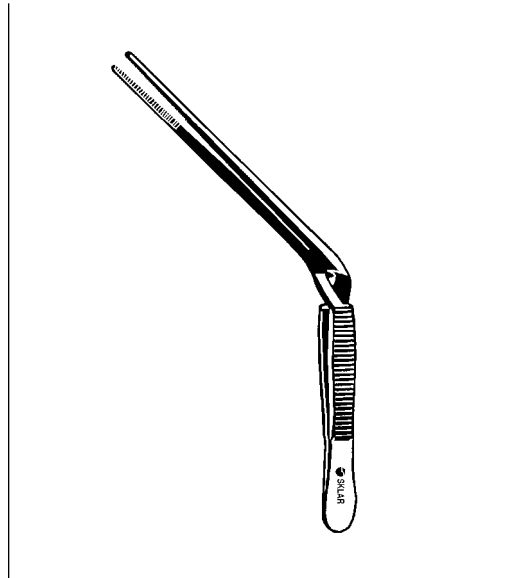
**DIETRICH
MICROCORONARY
BULLDOG CLAMP**

98-4008 8 mm Straight
 98-4012 12 mm Straight
 98-4020 20 mm Straight
 98-4108 8 mm Angled
 98-4112 12 mm Angled
 98-4120 20 mm Angled



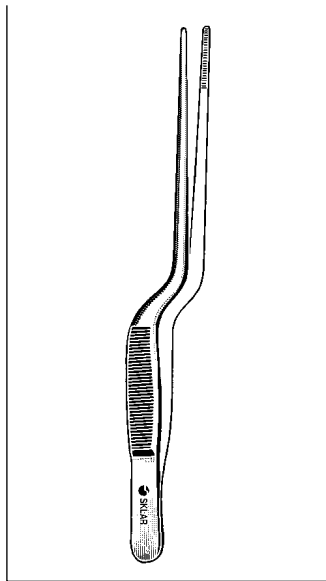
WILDE EAR FORCEPS

Angled
 67-1150 5" Serrated
 70-4470 7" Serrated



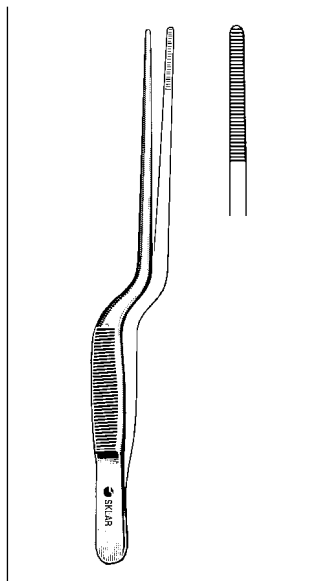
WILDE EAR FORCEPS

67-1350 5" Serrated jaws, Cross action
 67-1450 5" With mouse tooth, cross action



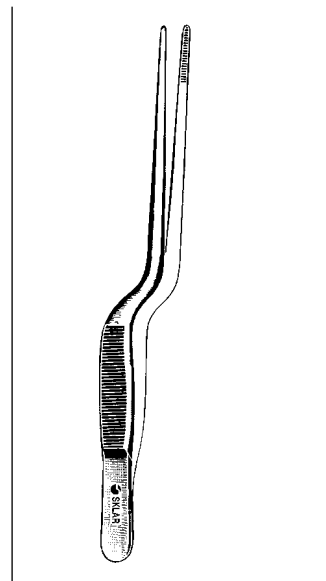
LUCAE BAYONET FORCEPS

67-1455 5½"



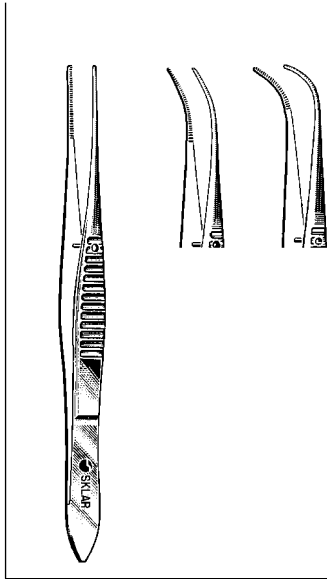
JANSEN NASAL FORCEPS

67-1465 6½"
 70-4375 7½"
 70-4385 8½"



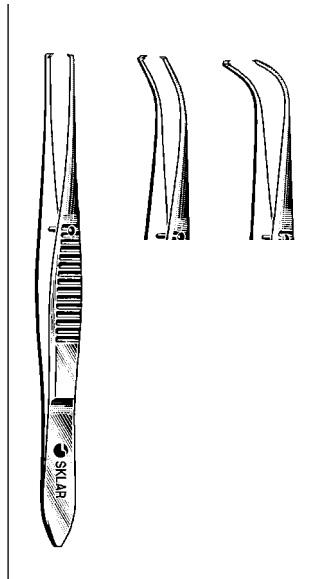
ADSON BAYONET FORCEPS

50-3371 7⅞" Delicate



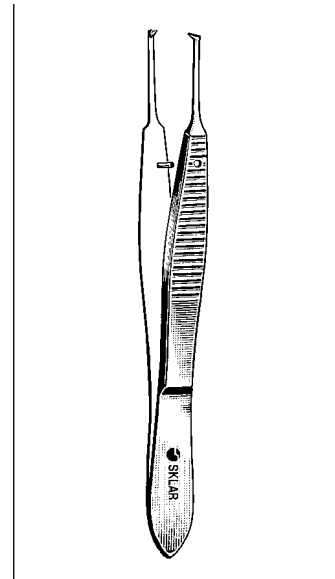
EYE DRESSING FORCEPS

- Serrated
 66-2740 4" Straight
 66-2940 4" Half Curve
 66-3140 4" Full Curve
 Non-Magnetic
 66-2840 4" Straight



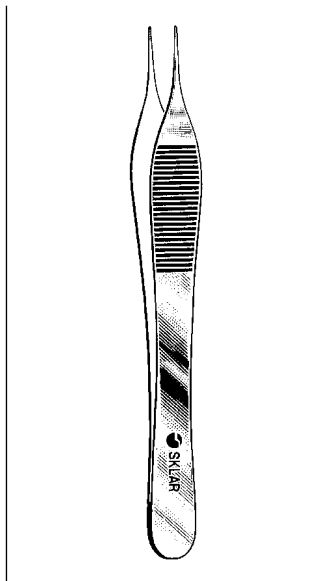
EYE TISSUE FORCEPS

- 1 x 2 Teeth
 66-3340 4" Straight
 66-3540 4" Half Curve
 66-3740 4" Full Curve
 Non-Magnetic
 66-3240 4" Straight



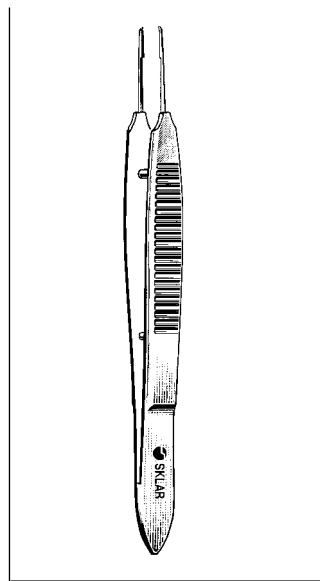
GRAEFE IRIS FORCEPS

- 66-4525 2 3/4" Straight 1 x 2
 66-4625 2 3/4" Full Curved 1 x 2



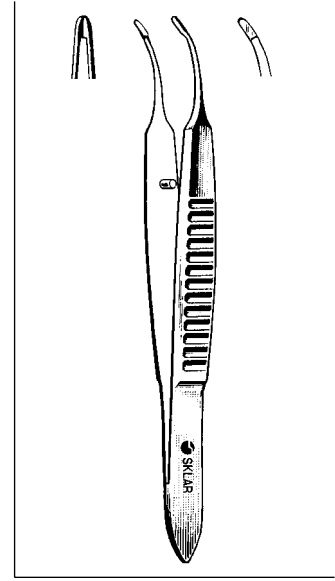
THORPE CORNEOSCLERAL FORCEPS

- 66-7347 4 3/4"



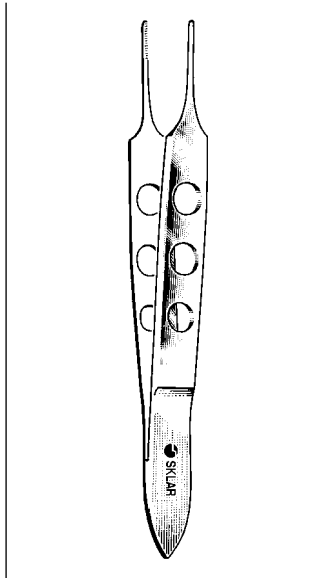
CASTROVIEJO FORCEPS

- With Platform
 66-6105 4" .5 mm teeth
 66-6109 4" .9 mm teeth



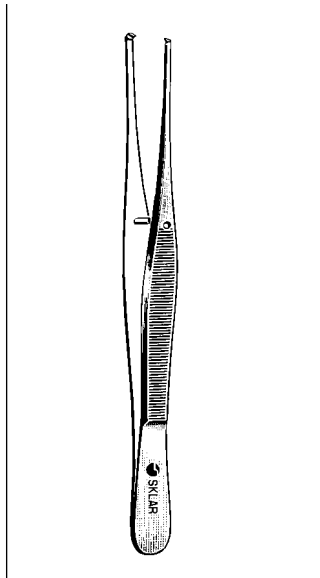
CHANDLER IRIS FORCEPS

- 66-3927 2 3/4" Curved with Platform



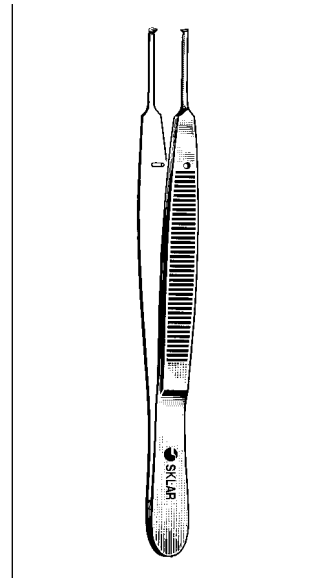
BISHOP-HARMON FORCEPS

- 66-4032 3½" Serrated
- 66-4132 3½" 1 x 2
- 66-4232 3½" 1 x 2 Micro



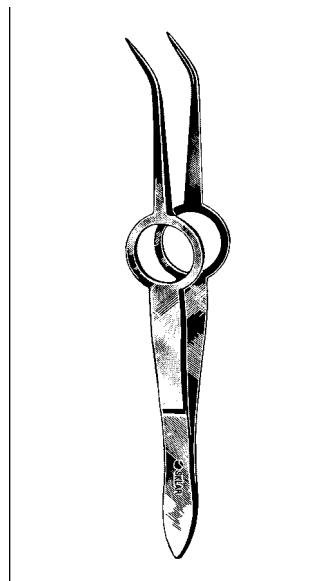
STRABISMUS FORCEPS

- 66-4840 4" Straight 1 x 2



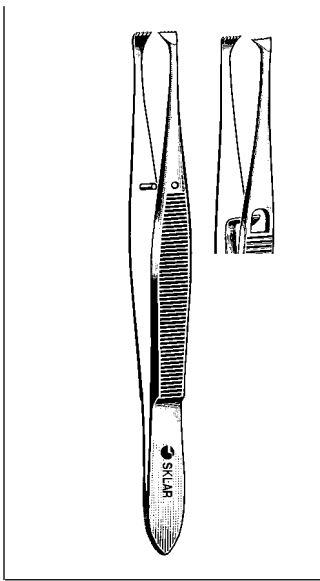
LESTER CONJUNCTIVAL FORCEPS

- 66-4235 3⅝" 1 x 2 Non-Magnetic



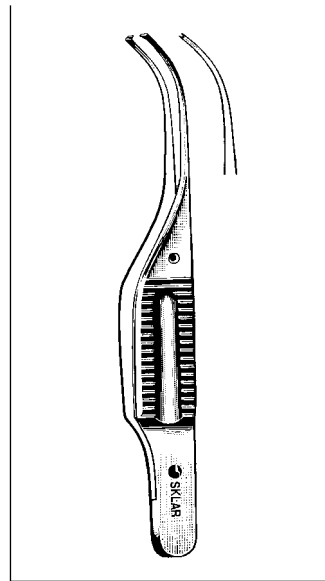
SCHAAF FOREIGN BODY FORCEPS

- 66-6037 3¾"



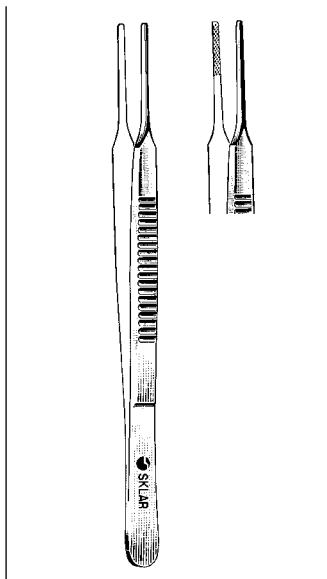
GRAEFE FIXATION FORCEPS

- 66-1940 4½" Without Lock
- 66-2140 4½" With Lock



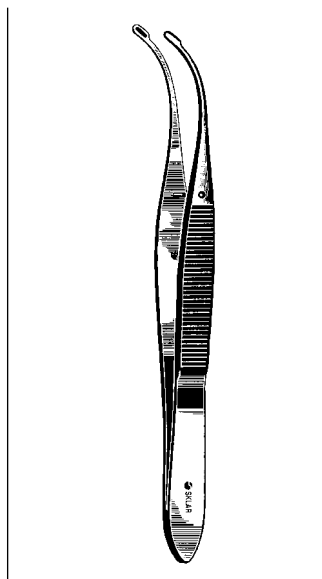
GILL IRIS FORCEPS

- 66-7130 3" Smooth Delicate
- 66-7230 3" Smooth Extra Delicate



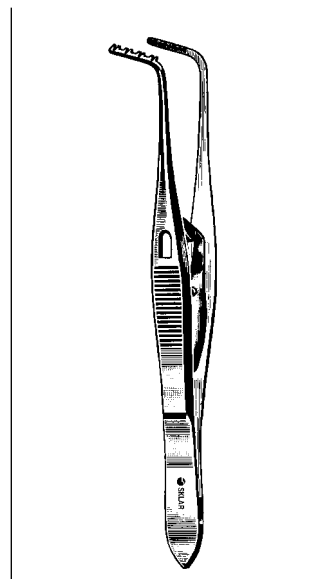
**McCULLOUGH UTILITY
FORCEPS**

66-6110 4" Serrated
66-6112 4" Smooth



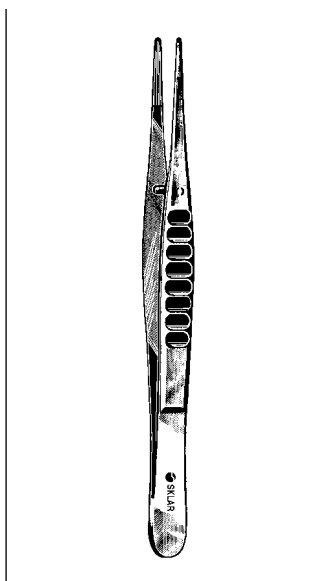
**ARRUGA CAPSULE
FORCEPS**

66-5340 4"



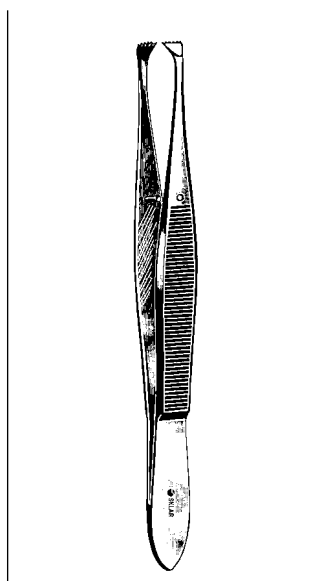
**PRINCE ADVANCEMENT
FORCEPS**

66-5942 4 1/4"



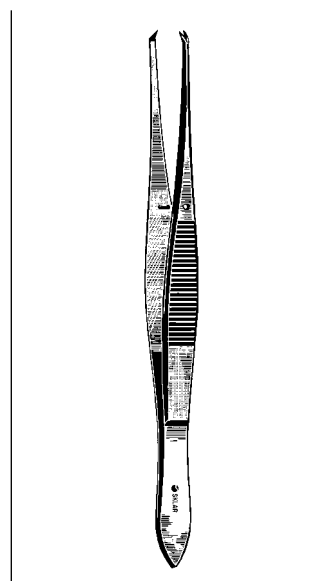
BONACCOLTO FORCEPS

66-6340 4"



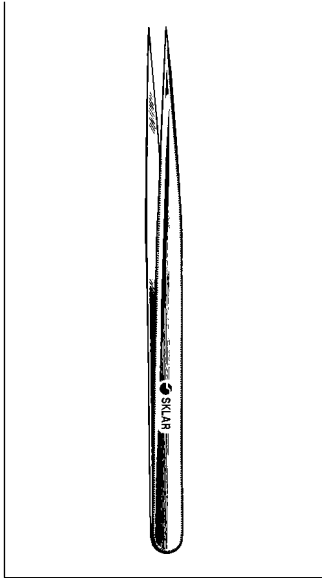
GRAEFE FORCEPS

66-2040 4 1/8" Without catch,
Non-magnetic

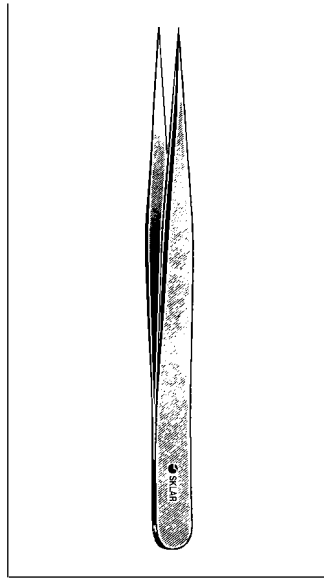


SKLAR TISSUE FORCEPS

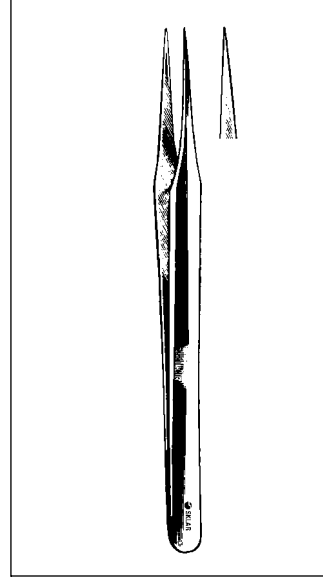
66-2540 4" Extra Delicate 1 x 2



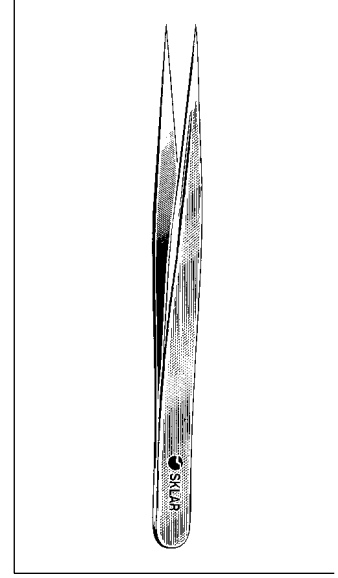
JEWELERS FORCEPS
66-7436 4 3/4" With extra fine tips, Style P



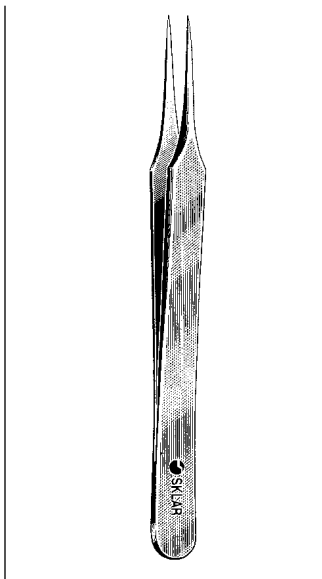
JEWELERS FORCEPS
66-7438 4 5/8" With fine tips, Style 1



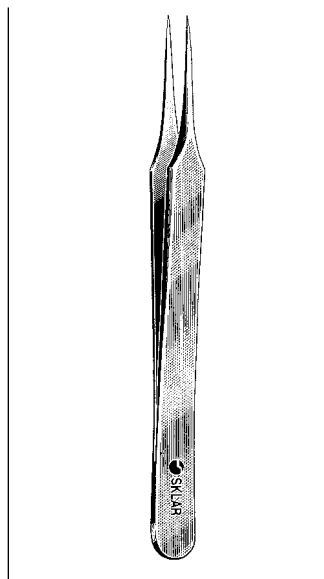
JEWELERS FORCEPS
66-7440 4 1/4" With fine tips, Style 2



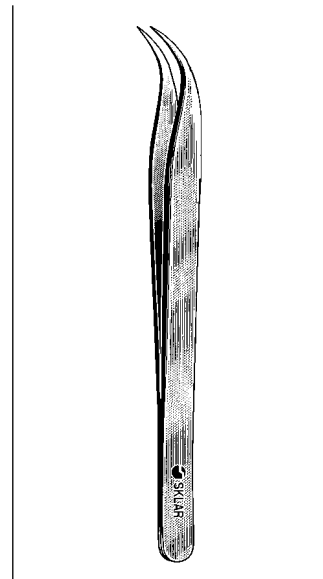
JEWELERS STYLE FORCEPS
66-7447 #3 Straight
66-7442 #3C Straight Delicate



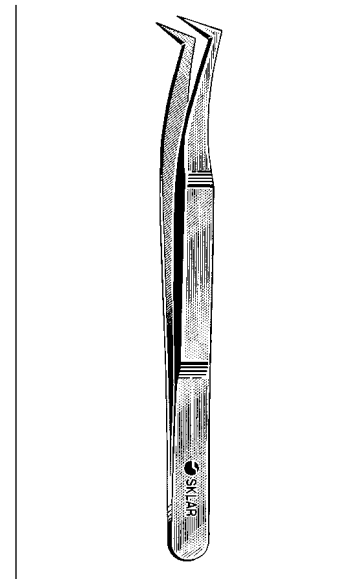
JEWELERS STYLE FORCEPS
66-7542 #4 Straight Delicate



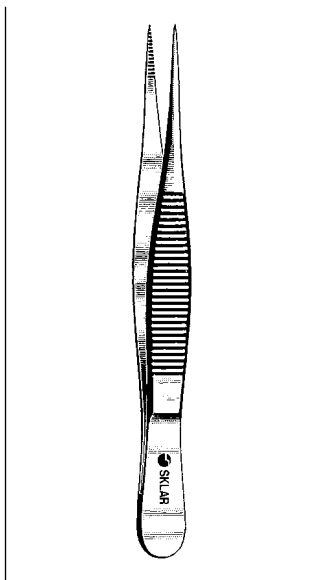
JEWELERS STYLE FORCEPS
66-7642 #5 Straight



JEWELERS STYLE FORCEPS
66-7644 #6 Curved

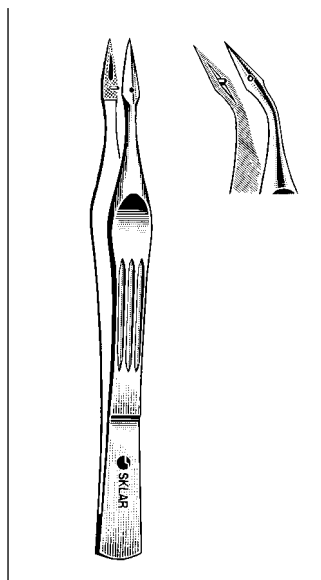


JEWELERS STYLE FORCEPS
66-7645 #7 Angled



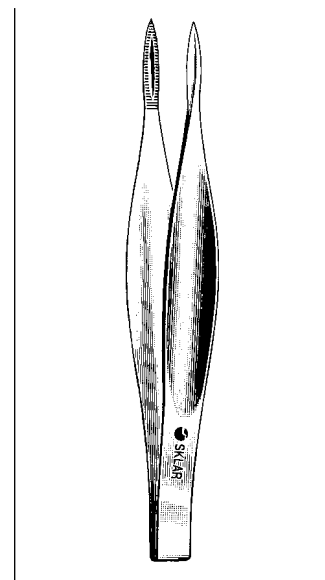
**FINE POINT SPLINTER
FORCEPS**

19-3035 3½"
19-3040 4"
19-3045 4½"



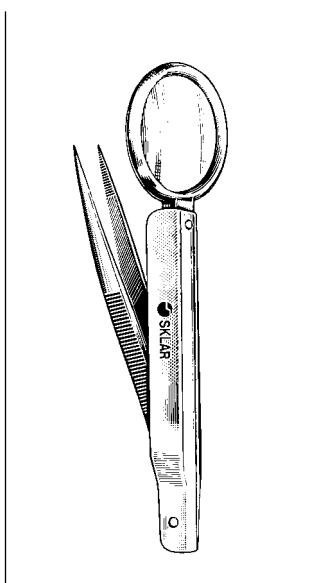
**CARMALT SPLINTER
FORCEPS**

19-3240 4" Straight
19-3340 4" Curved



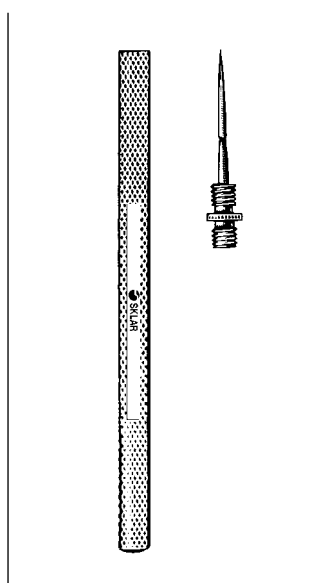
**FEILCHENFELD SPLINTER
FORCEPS**

19-2930 3"
19-2945 4½"



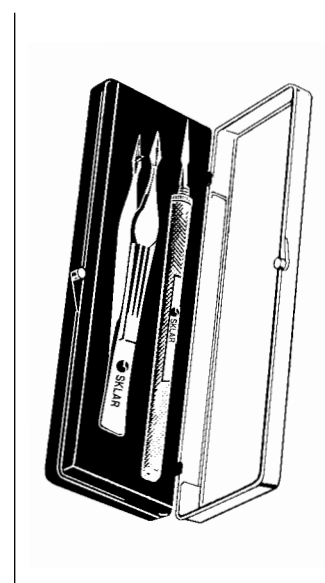
**PLAIN SPLINTER FORCEPS
WITH MAGNIFIER**

19-3030 3" Chrome
Non-Autoclavable



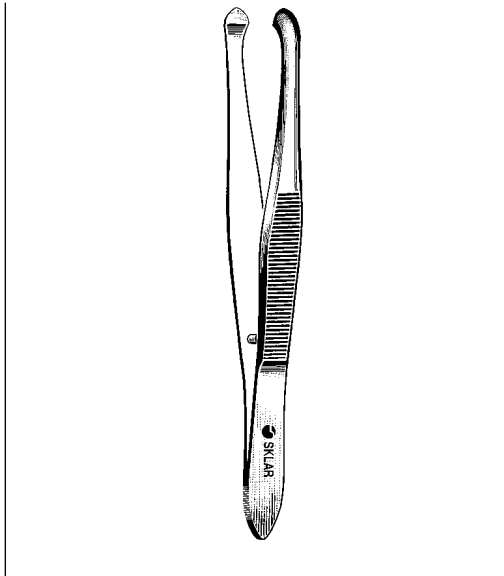
**VANGUARD SPLINTER
PICK**

19-3350 Chrome



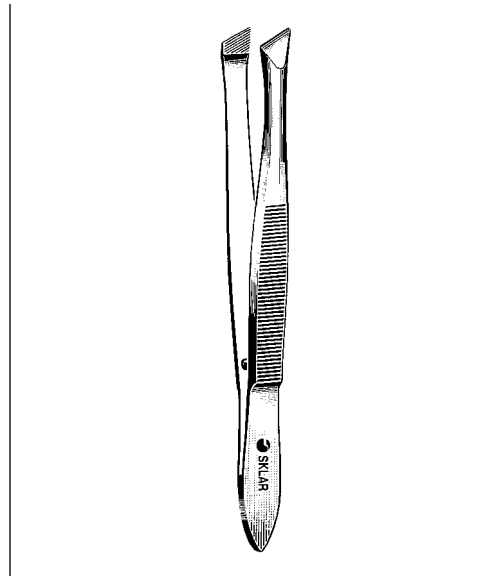
**SKLAR SPLINTER
REMOVAL KIT**

19-3360 containing one 19-3240
and one 19-3350 in a
convenient storage case.



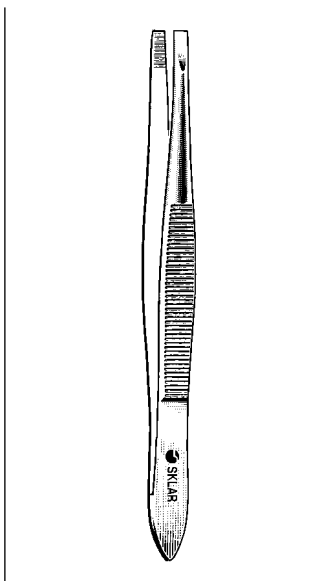
ZIEGLER CILIA FORCEPS

66-1535 3 1/2"



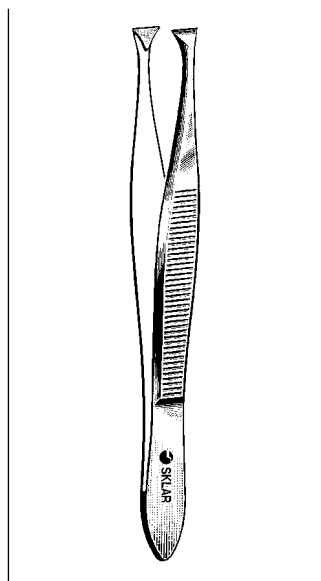
BERGH CILIA FORCEPS

66-1635 3 1/2"



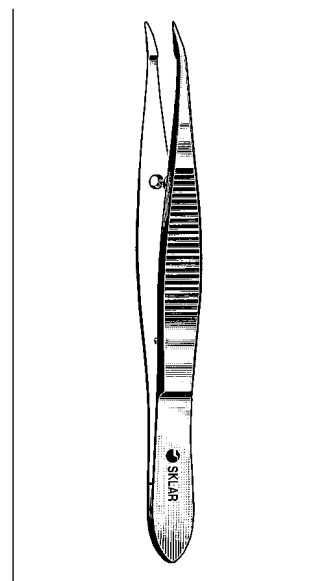
DOUGLASS CILIA FORCEPS

66-1830 3 1/2"



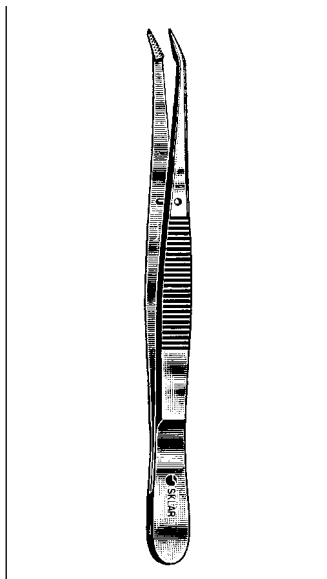
LITTAUER CILIA FORCEPS

66-1735 3 1/2"



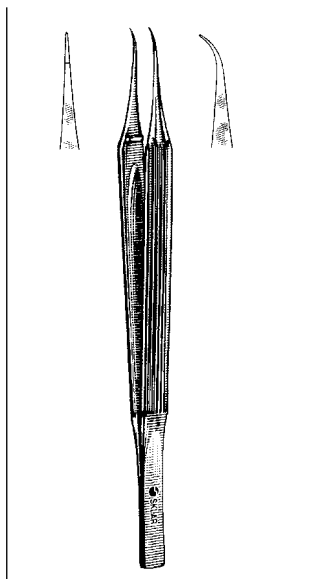
BARRAQUER CILIA FORCEPS

66-1742 4 1/4"



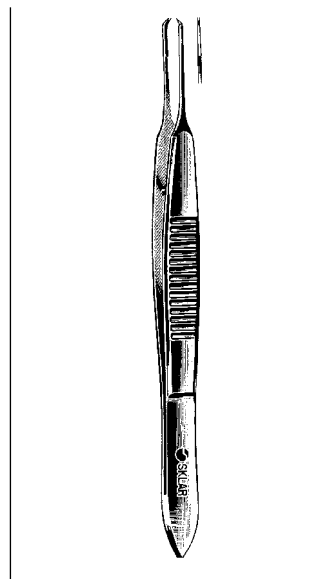
HEALY SUTURE FORCEPS

24-2155 5½"



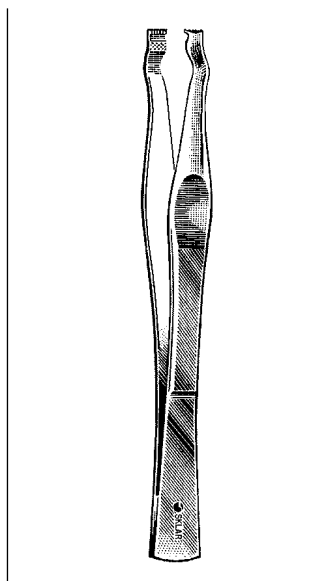
MICRO SUTURE TYING FORCEPS

98-2080 6" Straight
98-2081 6" Curved



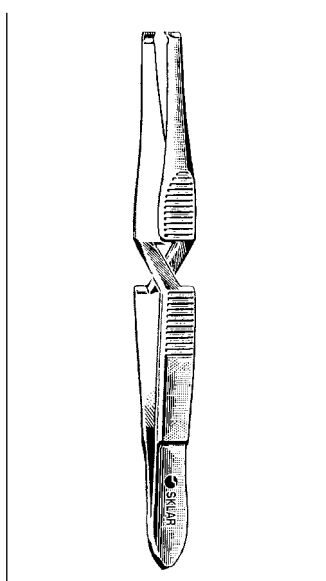
CASTROVIEJO SUTURE FORCEPS

66-6105 4" .5 mm teeth
66-6109 4" .9 mm teeth



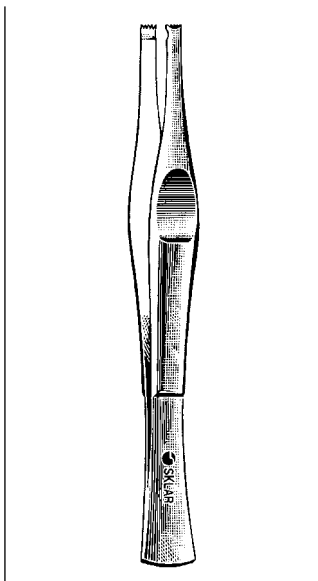
WACHENFELDT CLIP FORCEPS

24-1350 5"



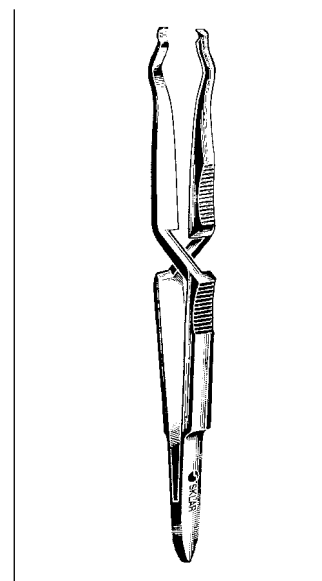
HEGENBARTH CLIP FORCEPS

Straight
24-1650 5"



MICHEL CLIP APPLYING FORCEPS

24-1150 5"



WACHENFELDT CLIP FORCEPS

X-Action
24-1450 5"



Sklar T-C Insert Forceps *Grip Vessels, Tissues And Sutures* *Firmly Yet Gently*

SKLAR T-C INSERT™ forceps are designed to provide long-lasting, positive holding power. SKLAR T-C INSERT™ forceps utilize a special non-slip tissue gripping profile, which enables the user to apply exactly the amount of pressure needed for proper tissue handling and suture tying with reduced trauma.

SKLAR T-C INSERT™ forceps with durable tungsten-carbide inlays; exceptionally fine milled serrations, easy-find gold-plated handles; and a full *5-year performance guarantee* make SKLAR T-C INSERT™ forceps the surgeon's choice.



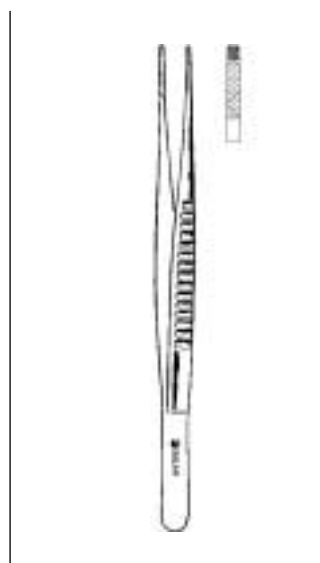
T-C ALLIS FORCEPS

97-1555 6"
97-1560 7½"



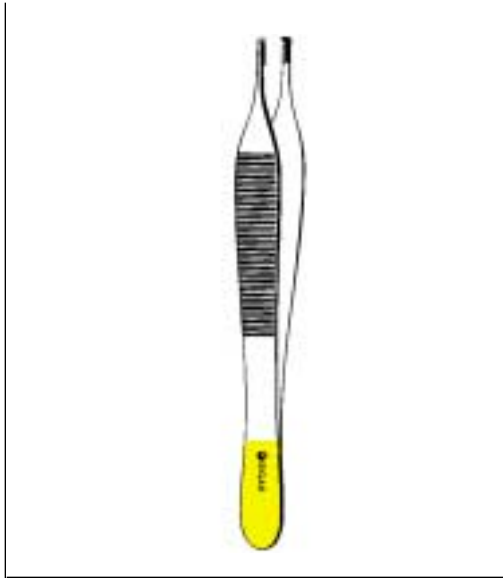
T-C BABCOCK FORCEPS

97-1565 6¼"
97-1570 8"



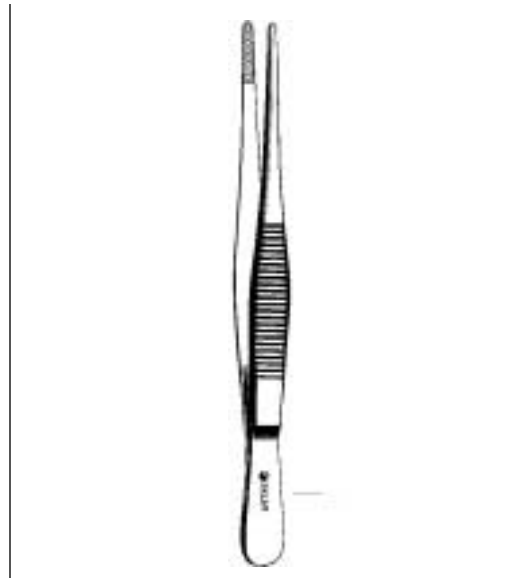
T-C DEBAKEY FORCEPS

97-1530 6" 2.0 mm Tips
97-1531 6" 2.7mm Tips
97-1540 8" 2.0 mm Tips
97-1541 8" 2.7mm Tips



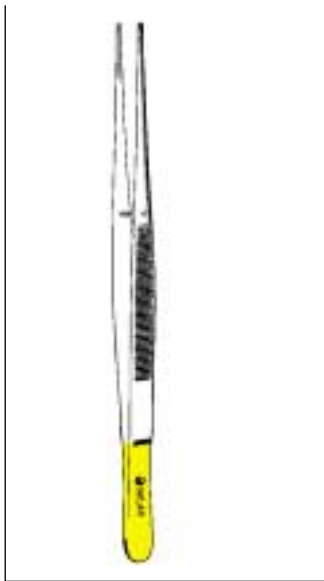
**T-C ADSON DRESSING
FORCEPS**

51-3447 4³/₄" Serrated
51-3049 1X2 w/platform



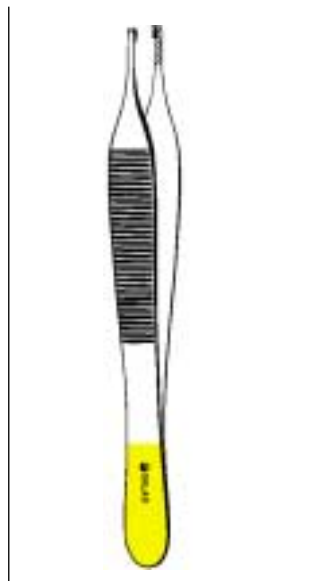
T-C DRESSING FORCEPS

51-3460 6" Serrated
51-3480 8" Serrated



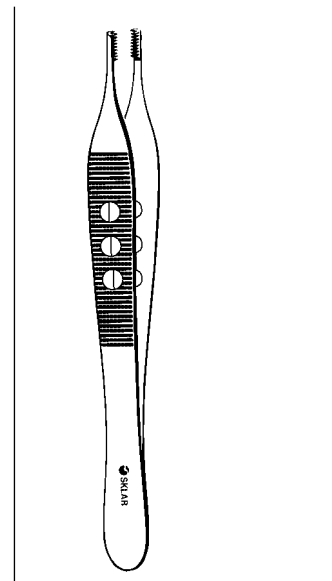
**T-C POTTS-SMITH
DRESSING FORCEPS**

51-4360 6" Serrated
51-4370 7" Serrated
51-4382 8¹/₄" Serrated
51-4395 9¹/₂" Serrated



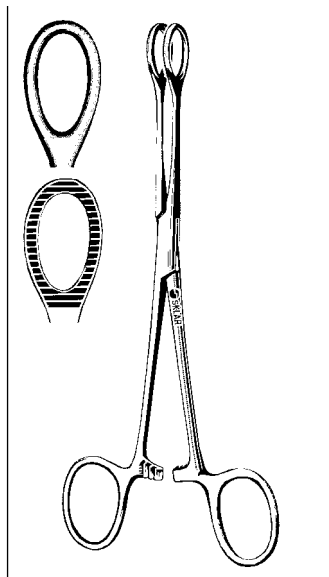
**T-C ADSON BROWN
FORCEPS**

Side Grasping
51-1447 4³/₄"



**SKLAR LITEGRIP™ T-C
ADSON-BROWN TISSUE
AND SUTURE FORCEPS**

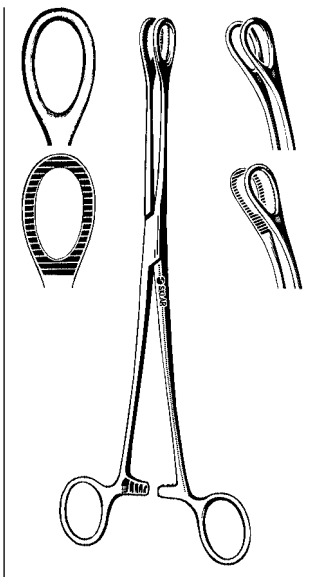
51-1448 4³/₄" Side Grasping with
Tungsten Carbide
insert 4³/₄"



BALLENGER SPONGE FORCEPS

Straight
 74-1370 7" Smooth
 74-1470 7" Serrated

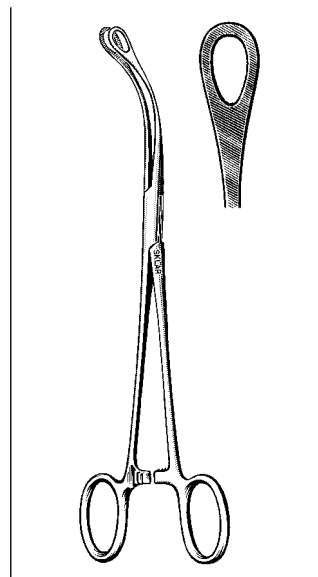
Curved
 74-1570 7" Smooth
 74-1670 7" Serrated



FOERSTER SPONGE FORCEPS

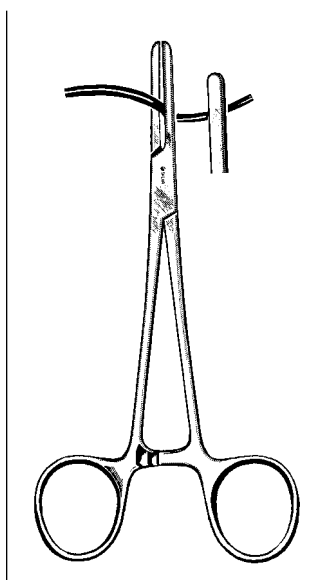
Straight
 87-2095 9½" Smooth
 87-2195 9½" Serrated

Curved
 87-2295 9½" Smooth
 87-2395 9½" Serrated



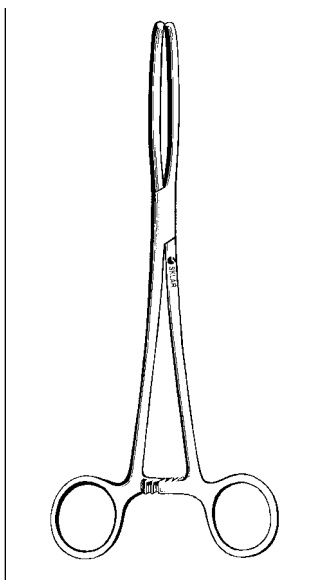
PEANUT SPONGE FORCEPS

22-9380 8" Smooth Straight
 22-9480 8" Serrated Curved



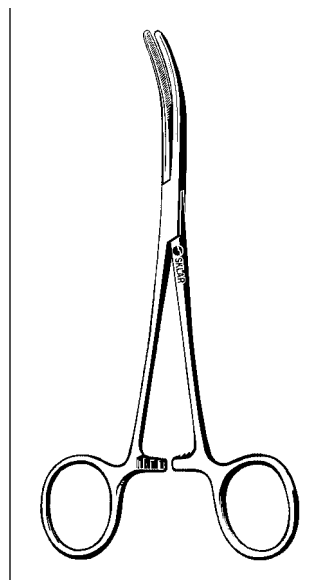
TUBE OCCLUDING CLAMPS

Smooth Jaw, Straight
 17-3995 5½"
 17-3996 6½"
 17-3997 7¼"



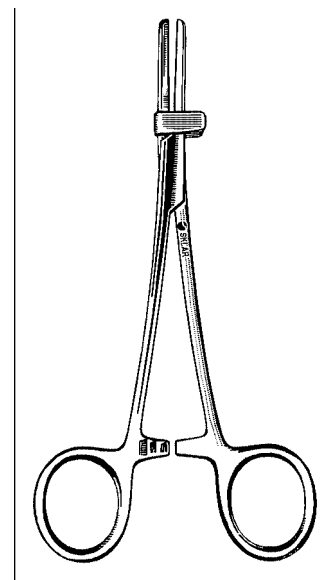
MARCUSE TUBING FORCEPS

Straight
 17-3955 5½" Smooth
 17-3965 6½" Smooth
 17-3980 8" Smooth



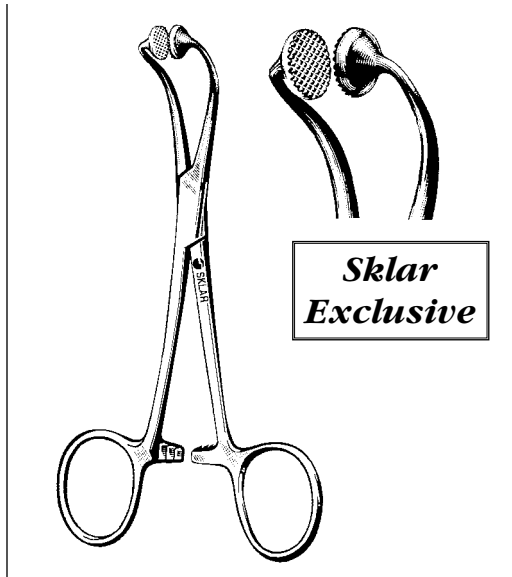
ST. VINCENT TUBING FORCEPS

Curved
 17-3962 6¼" Standard
 17-3970 7" Heavy



SKLAR TUBING FORCEPS

Straight-Serrated
 17-3960 6" With Guard



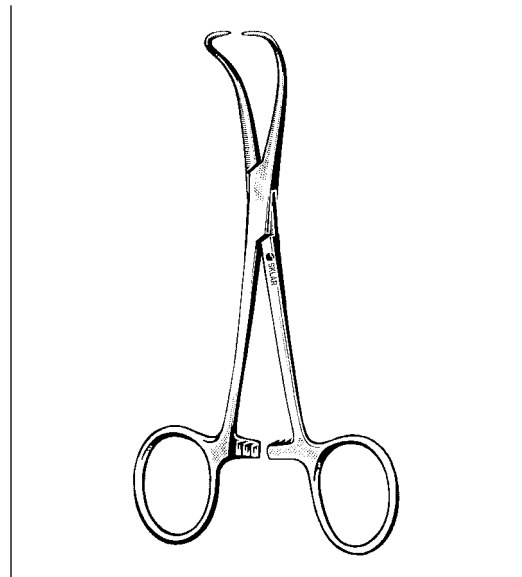
HOFF TOWEL CLAMP

Stainless Steel

47-3040 4"
47-3057 5¼"

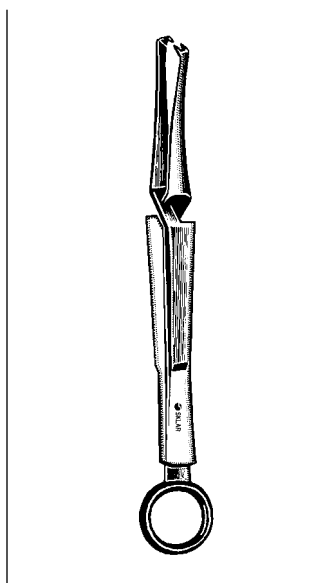
Sklar Exclusive

Serrated disc jaws effectively clamp— but will not tear or penetrate cloth or disposable drapes and towels. Can be removed and reapplied without contamination of the field. Also useful to secure cords and tubings to drapes.



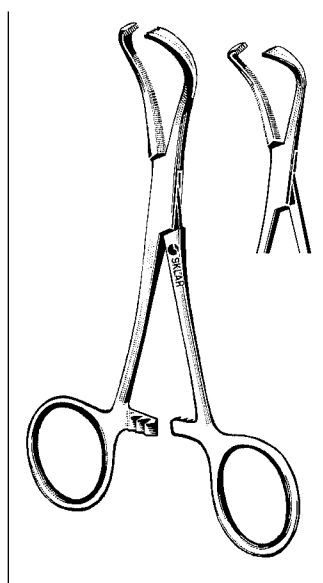
BACKHAUS TOWEL CLAMP

47-2935 3½"
47-2955 5¼"



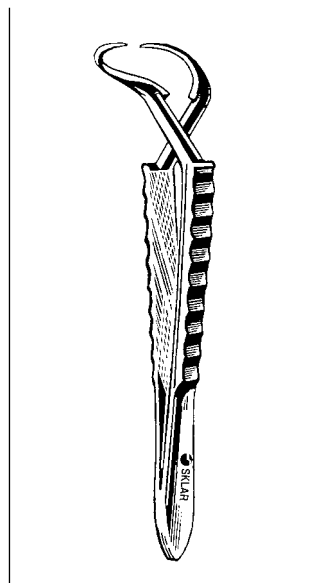
SKLAR TOWEL CLAMP CROSS ACTION

87-1070 7"



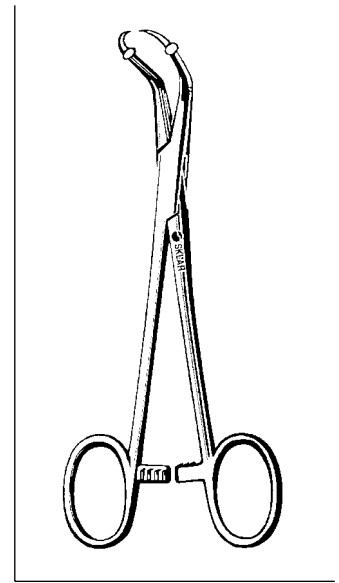
LORNA (EDNA) TOWEL CLAMP

Non-Perforating
47-2837 4"
47-2852 5¼"



JONES CROSS ACTION TOWEL CLAMP

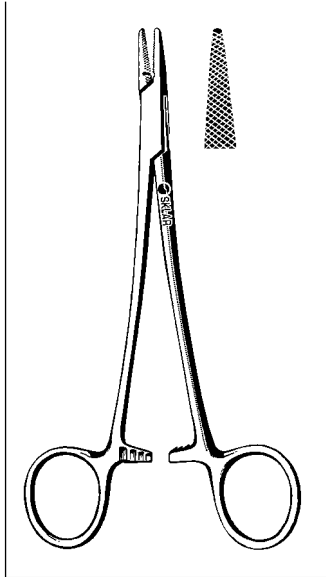
47-2925 2¼" Delicate
47-2930 3½"



ROEDER TOWEL CLAMP

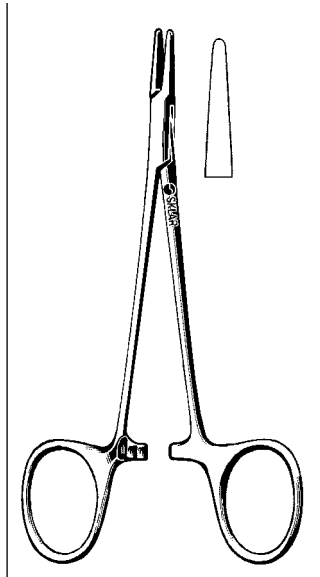
87-1052 5¼" With Ball Stops

NEEDLE HOLDERS



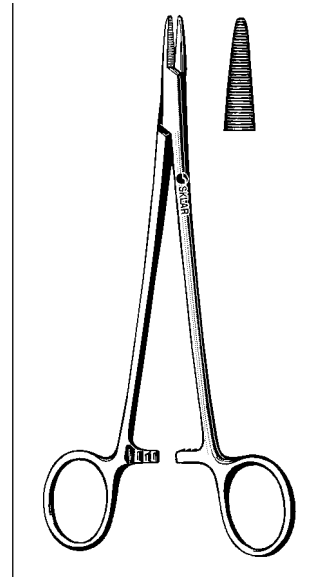
**CRILE-MURRAY
NEEDLE HOLDER**

20-1260 6" Serrated



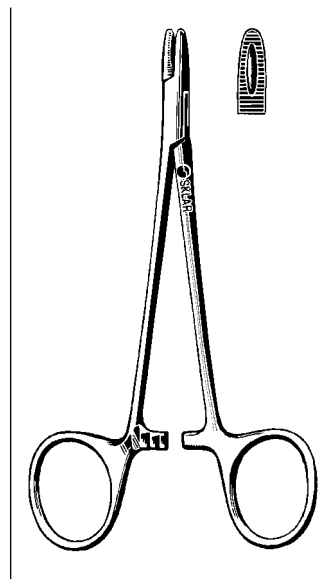
**WEBSTER
NEEDLE HOLDER**

Delicate
20-1350 5" Smooth
20-1352 5" Serrated



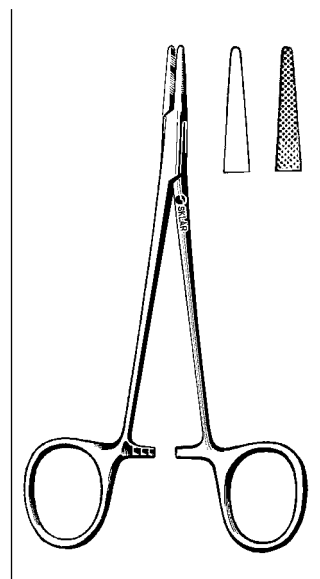
**BROWN
NEEDLE HOLDER**

Rounded Jaws
20-4852 5 1/4"
20-4867 6 3/4"



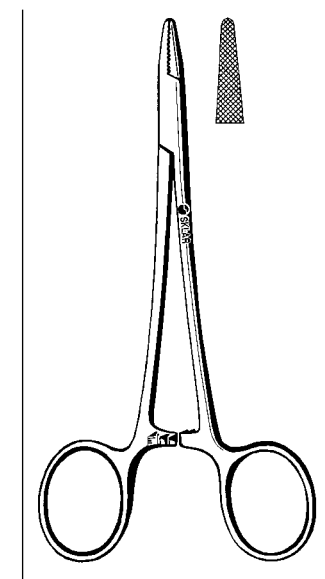
DERF NEEDLE HOLDER

20-1547 4 3/4" Serrated



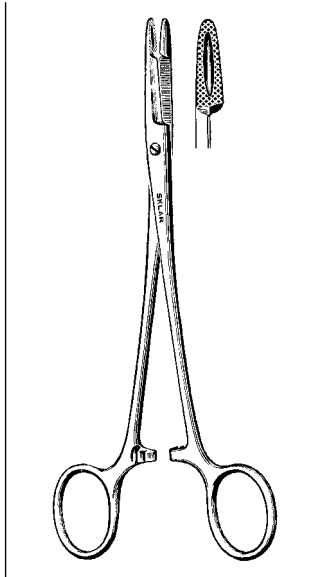
**HALSEY
NEEDLE HOLDER**

20-1750 5" Smooth
20-1751 5" Serrated



**BAUMGARTNER
NEEDLE HOLDER**

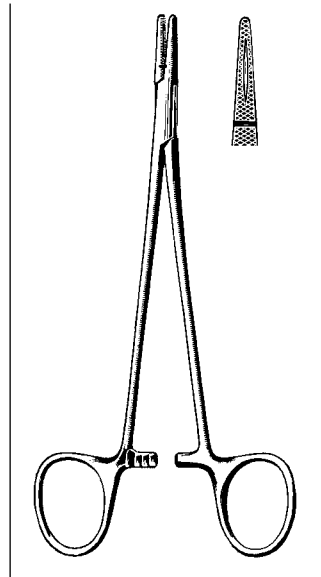
20-1450 5" Serrated



OLSEN-HEGAR NEEDLE HOLDER

Scissors Combination

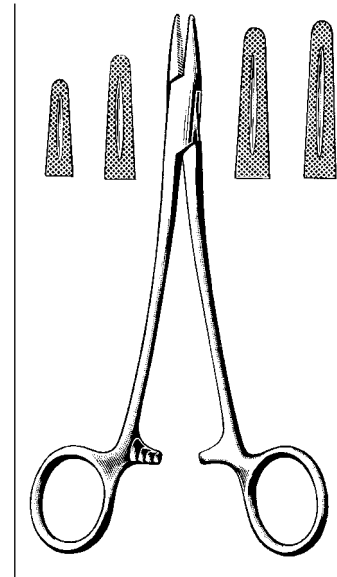
20-2747	4¾"	Delicate
20-2755	5½"	
20-2765	6½"	
20-2775	7"	



CRILE-WOOD NEEDLE HOLDER

Serrated

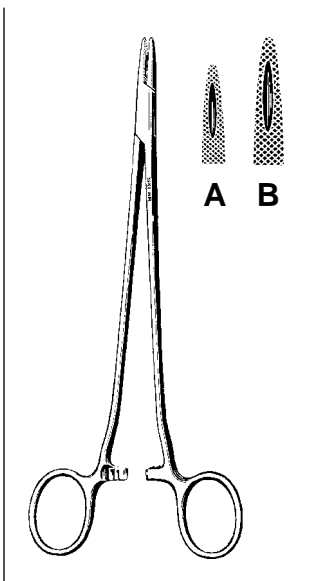
20-1265	6"	Narrow Jaw
20-1270	7"	DeBakey Type
20-1280	8"	DeBakey Type
20-1290	9"	DeBakey Type
20-1295	10½"	DeBakey Type



MAYO-HEGAR NEEDLE HOLDER

Serrated

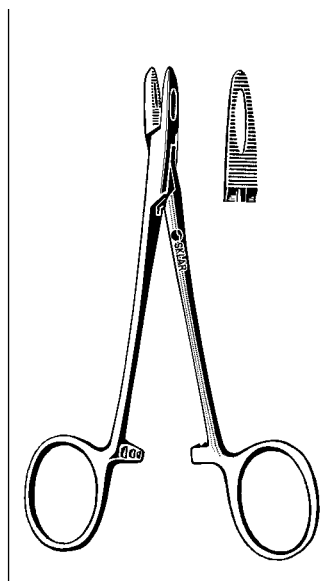
20-2052	5¼"	20-2480	8"
20-2060	6"	20-2910	10½" Masson
20-2070	7"	20-2911	11½" Masson
20-2270	7"	Broad Jaw	



SAROT NEEDLE HOLDER

Serrated

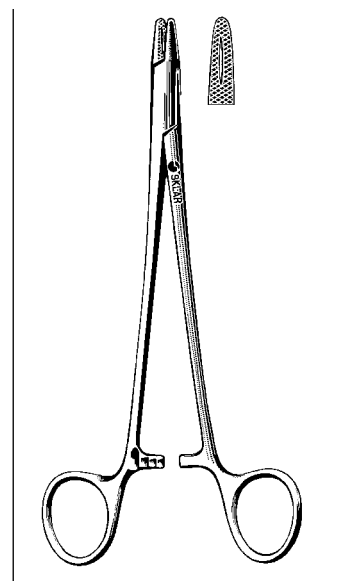
22-5050	5"	Pediatric "A" Jaw
20-4170	7½"	"A" Jaw
20-3910	10¾"	"B" Jaw



COLLIER NEEDLE HOLDER

Fenestrated Jaw

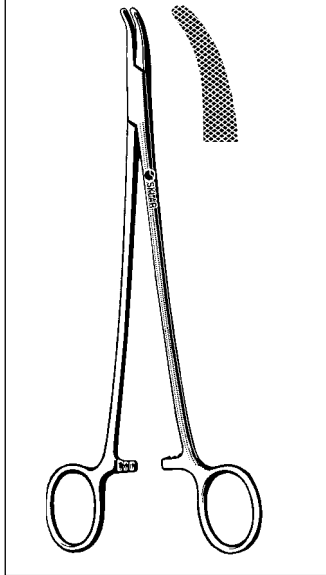
65-6550	5"	Serrated
---------	----	----------



NEW ORLEANS NEEDLE HOLDER

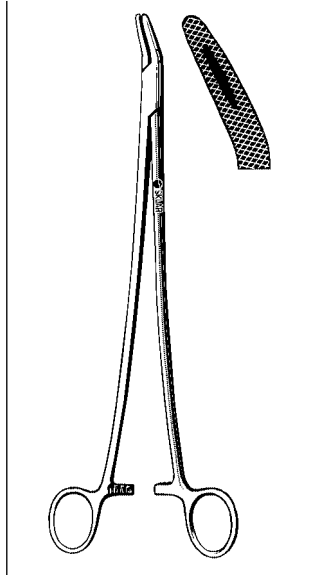
20-1870	7"	Serrated
---------	----	----------

NEEDLE HOLDERS



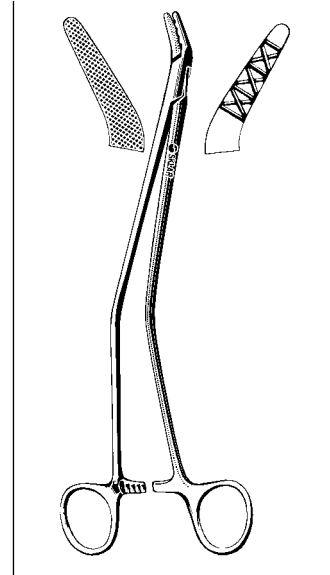
**HEANEY
NEEDLE HOLDER**

20-4682 8¼"



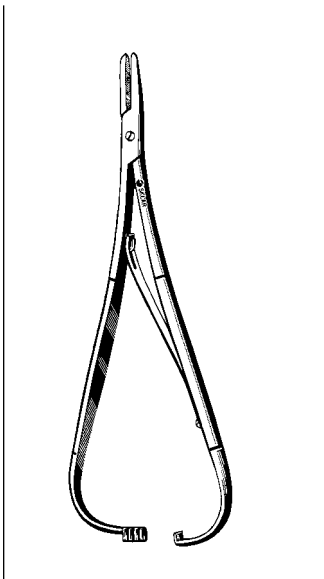
**FINOCHIETTO
NEEDLE HOLDER**

20-4510 10¼"



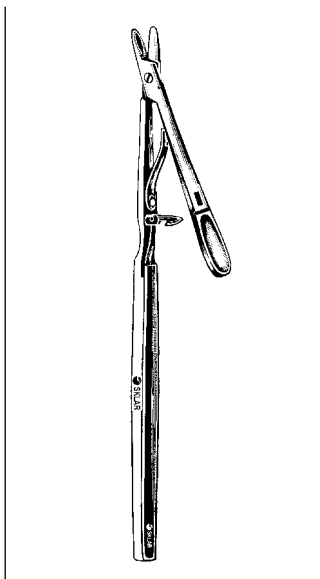
**JOHNSON
NEEDLE HOLDER**

20-4610 10¾"



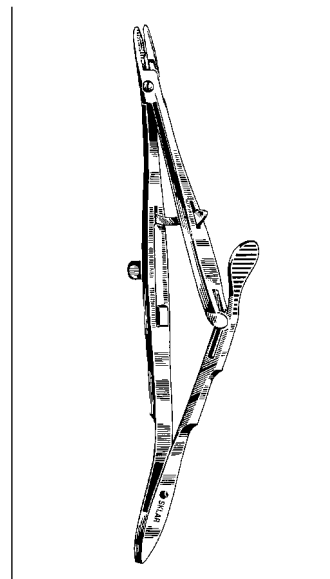
**MATHIEU
NEEDLE HOLDER**

20-3055 5½"
20-3075 7½"



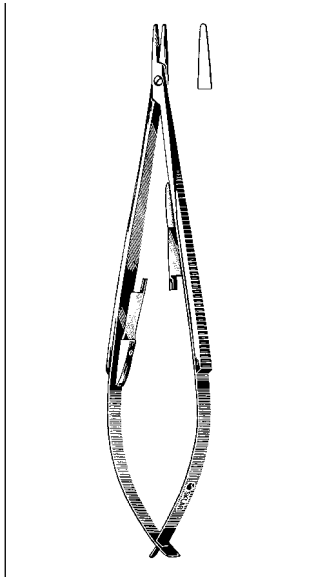
**STEVENS
NEEDLE HOLDER**

65-6265 6½"



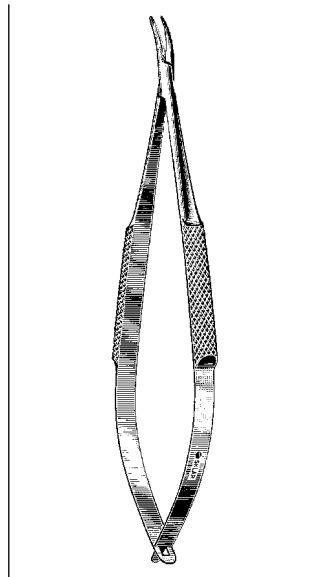
**CASTROVIEJO-KALT
NEEDLE HOLDER**

With Suture Cutter
65-6255 5½"



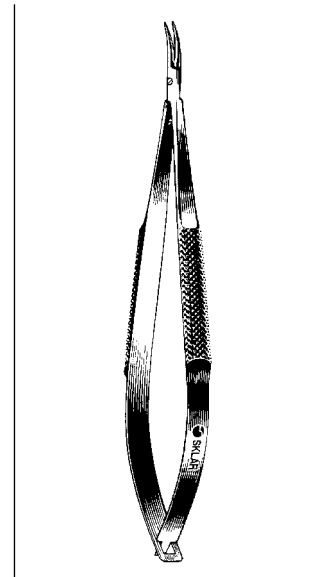
**CASTROVIEJO
NEEDLE HOLDER**

With catch
65-6357 5½"



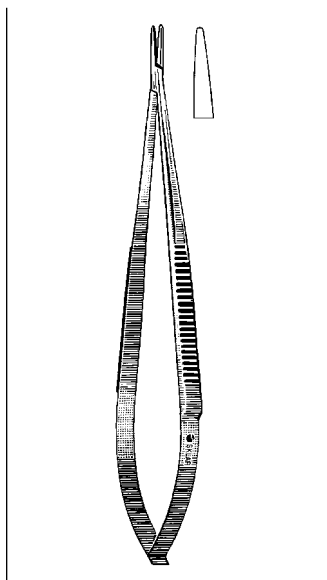
**BARRAQUER
NEEDLE HOLDER**

Curved w/o catch
65-6452 4½"



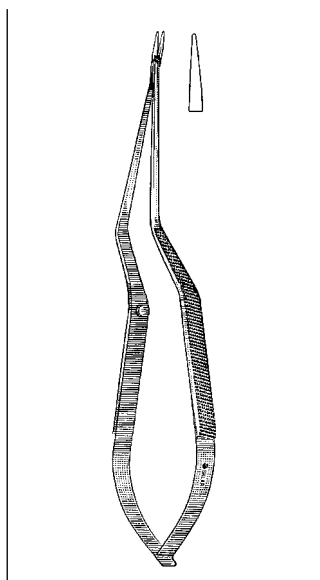
**STANGEL-BARRAQUER
NEEDLE HOLDER**

65-6552 4½"



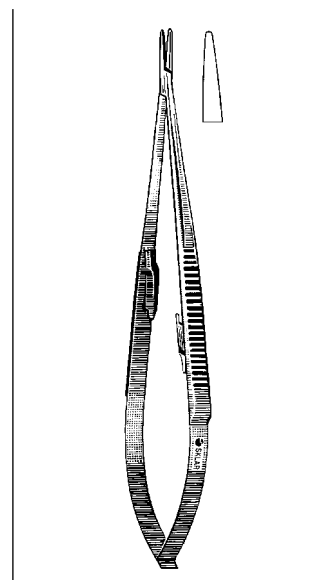
**JACOBSON MICRO
NEEDLE HOLDER**

98-3070 7" Str. Smooth w/o catch
98-3085 8½" Str. Smooth w/o catch



**JACOBSON
NEEDLE HOLDER**

Bayonet
98-3086 8½"



**JACOBSON MICRO
NEEDLE HOLDER**

98-3170 7" Str. Smooth w/catch
98-3171 7" Cvd. Smooth w/catch

TUNGSTEN CARBIDE NEEDLE HOLDERS



SklarGrip™ Tungsten Carbide Needle Holders

3 Year Warranty

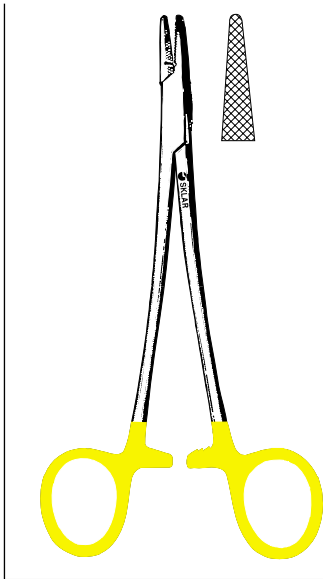
SKLAR GRIP™ tungsten carbide needle holders are warranted for three full years of normal use. During this warranty period, if any adjustments become necessary, SKLAR will repair or replace the SKLAR GRIP™ tungsten carbide needle holders. A nominal charge will be made for repairs once the warranty period has expired. The non T-C portion of the instrument is guaranteed under Sklar's Lifetime Warranty.



The application of tungsten-carbide to needle holders assures excellent holding ability for many years. But SKLARGRIP's™ exclusive T-C coating process has two significant benefits:

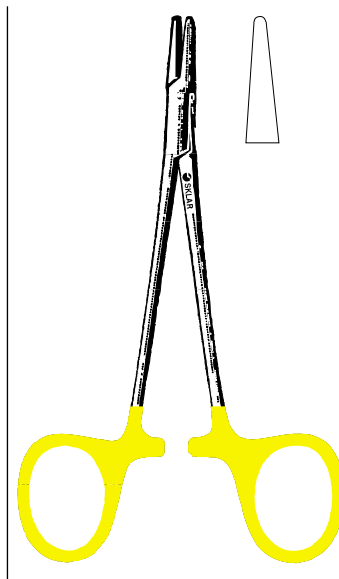
1. Sklar incorporates tungsten-carbide as an integral part of the jaw. The special coating and tempering process we employ preserves both the original temper and strength of the needle holder's jaws.
2. SKLARGRIP™ tungsten-carbide needle holders typically cost at least 10% less than T-C needle holders that use inserts.

In fact, Sklar is so certain of SKLARGRIP™ quality that we offer a *3-year guarantee* on our T-C coated SKLARGRIP™ needle holders.



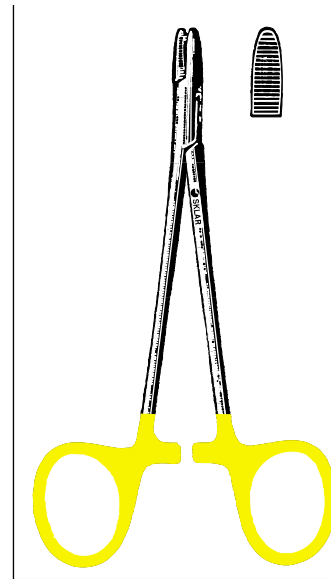
**SKLARGRIP™
T-C CRILE-MURRAY
NEEDLE HOLDER**

21-1260 6" Serrated



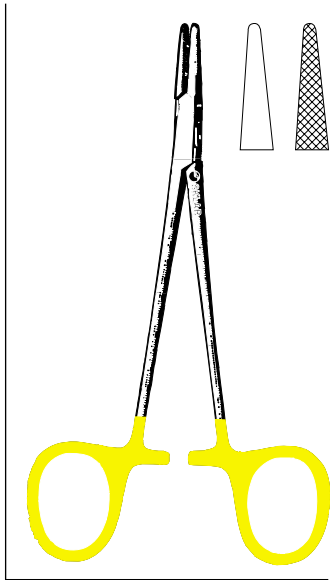
**SKLARGRIP™
T-C WEBSTER
NEEDLE HOLDER**

21-1650 5" Smooth
21-1652 5" Serrated



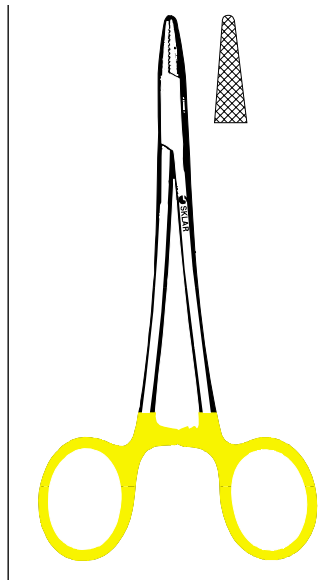
**SKLARGRIP™
T-C DERF
NEEDLE HOLDER**

21-1547 4¾" Serrated



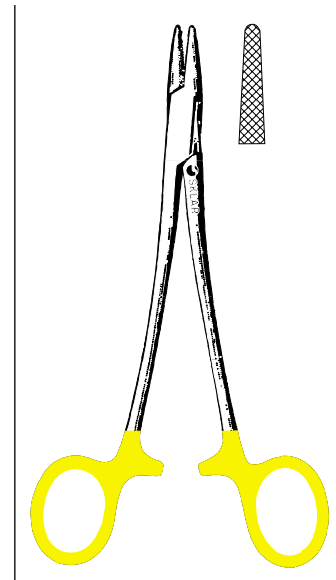
**SKLARGRIP™
T-C HALSEY NEEDLE
HOLDER**

Light Model
21-1750 5" Smooth
21-1850 5" Serrated



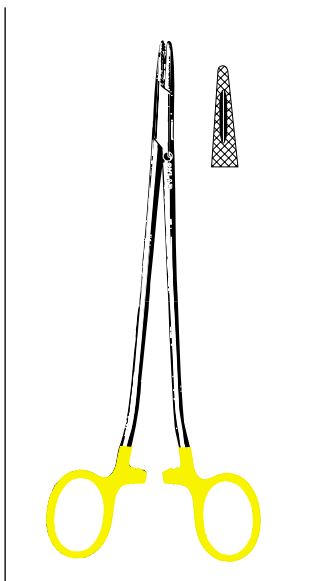
**SKLARGRIP™
T-C BAUMGARTNER
NEEDLE HOLDER**

21-1450 5" Serrated



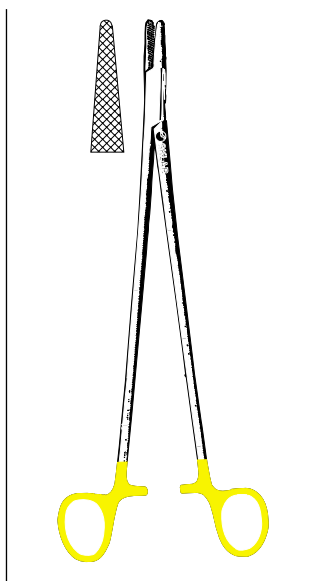
**SKLARGRIP™
T-C MAYO-HEGAR NEEDLE
HOLDER**

Serrated
21-2060 6" 21-2570 7" Broad Jaw
21-2070 7" Nar. 21-2910 10½" Masson
21-2480 8"



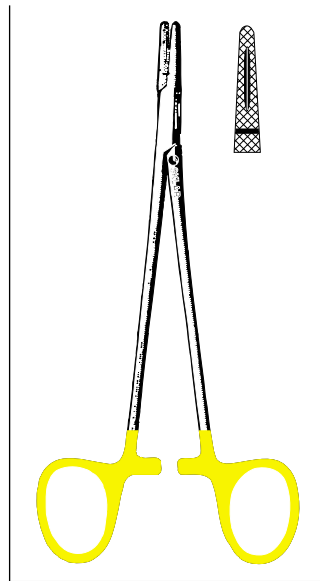
**SKLARGRIP™
T-C SAROT NEEDLE
HOLDER**

21-4170 7½" Serrated-Light



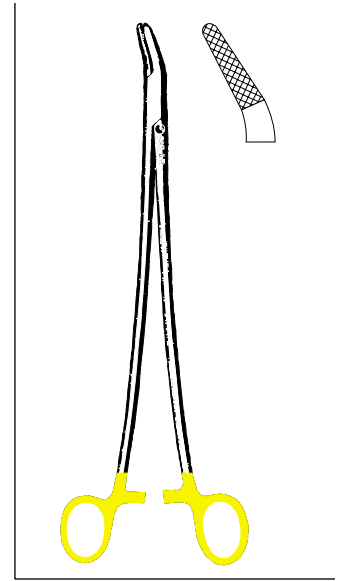
**SKLARGRIP™
T-C WANGENSTEEN
NEEDLE HOLDER**

21-3510 10½" Serrated



**SKLARGRIP™
T-C DEBAKEY NEEDLE
HOLDER**

21-4970 7" Serrated
21-4992 9" Smooth
21-5112 12" Serrated



**SKLARGRIP™
T-C HEANEY NEEDLE
HOLDER**

Curved
21-4682 8¼" Serrated



*Sklar T-C™ Needle Holders
Are Unconditionally
Guaranteed For Five Years*

5 Year Warranty

SKLAR T-C needle holder jaws with tungsten carbide inserts are warranted for five full years of normal use. During this warranty period, if any adjustments become necessary, SKLAR will repair or replace the SKLAR T-C needle holders. A nominal charge will be made for repairs once the warranty period has expired. The non T-C portion of the instrument is guaranteed under Sklar's Lifetime Warranty.

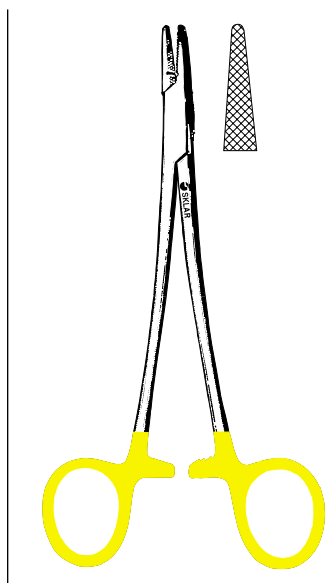
SKLAR T-C™ needle holders are designed to hold suture needles far more securely and firmly than standard needle holders. They utilize solid tungsten-carbide inserts for the longest life possible. All inserts have a precisely ground, virtually indestructible, pyramid profile that is harder than the needles they hold. The pyramid profile retains its original shape much longer than other needle holders. This profile ensures firm needle holding capability and virtually eliminates needle rotation.

SKLAR T-C™ needle holders feature graduated ratchet grips for safe, secure and exacting control over needle holding pressure, and gold plated rings for quick identification.

Sklar unconditionally guarantees SKLAR T-C™ needle holders for a full five years.

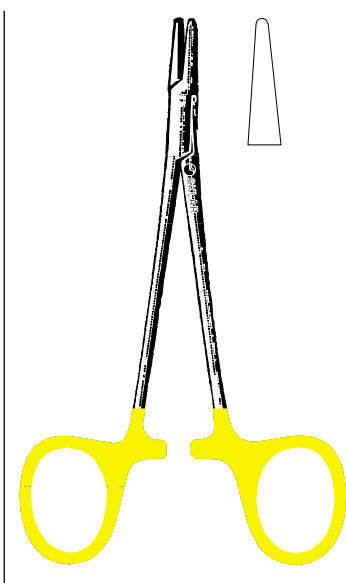


Sklar Exclusive!



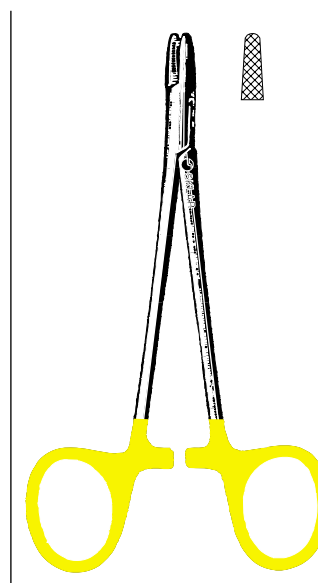
**T-C CRILE-MURRAY
NEEDLE HOLDER**

21-8075 6" Serrated



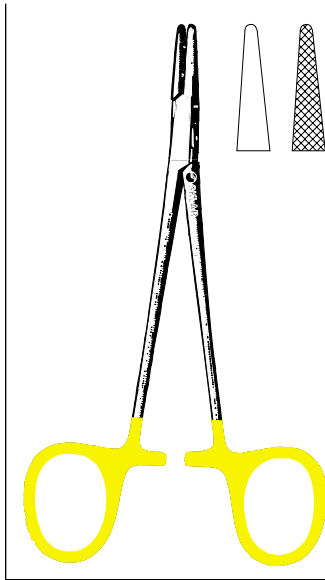
**T-C WEBSTER
NEEDLE HOLDER**

21-8002 5" Smooth
21-8080 5" Serrated



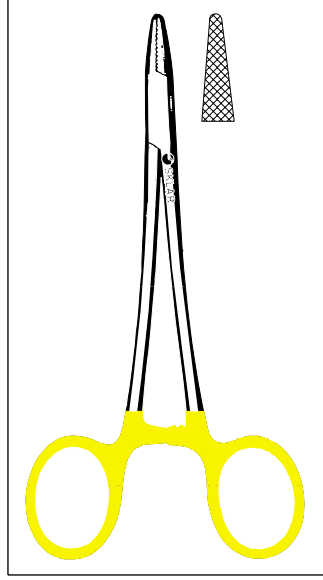
**T-C DERF
NEEDLE HOLDER**

21-8004 4 3/4" Serrated



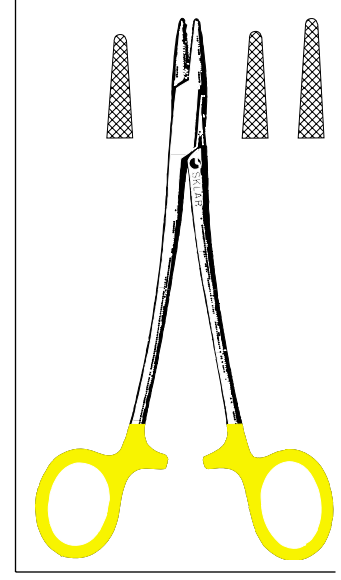
**T-C HALSEY
NEEDLE HOLDER**

21-8000 5" Smooth
21-8001 5" Serrated



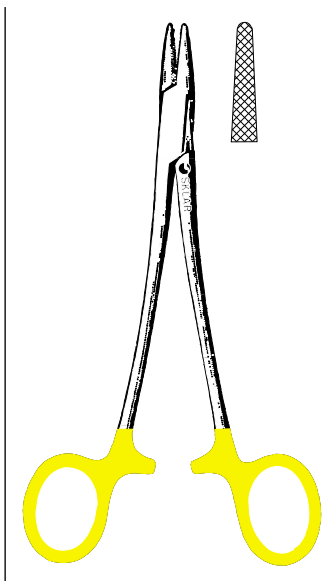
**T-C BAUMGARTNER
NEEDLE HOLDER**

21-8005 5" Serrated



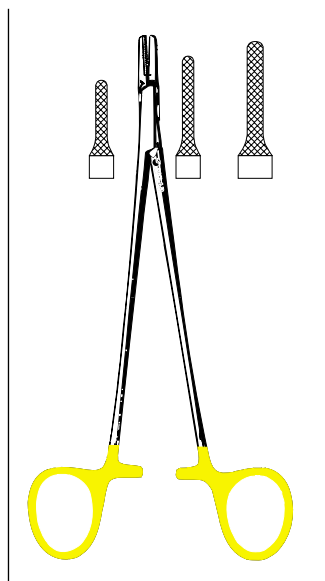
**T-C CRILE-WOOD
NEEDLE HOLDER**

Serrated
21-8006 6" Narrow
21-8007 7" DeBaKey
21-8008 8" DeBaKey
21-8009 9" DeBaKey
21-8010 10½" DeBaKey
21-8011 12" DeBaKey



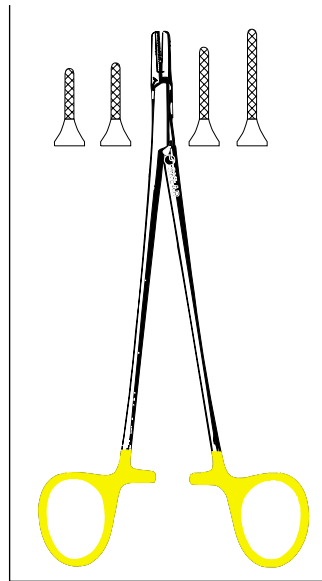
**T-C MAYO-HEGAR
NEEDLE HOLDER**

Serrated
21-8030 5¼"
21-8031 6"
21-8032 7"
21-8033 8"
21-8034 10½"
21-8035 12"



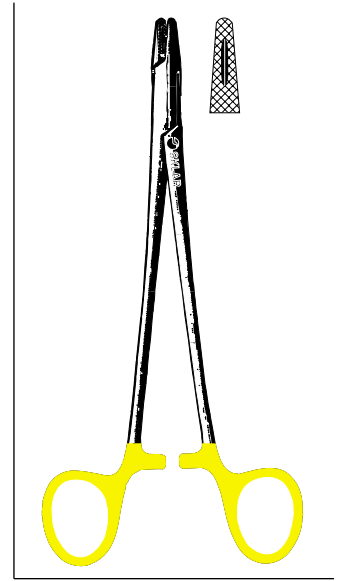
**T-C RYDER
NEEDLE HOLDER**

Serrated
21-8020 6"
21-8022 8"
21-8023 9"



**T-C RYDER
NEEDLE HOLDER**

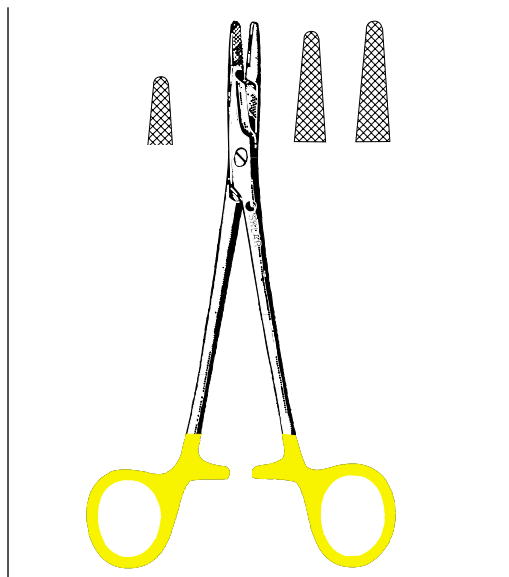
Micro-Serrated
21-8012 5"
21-8013 6"
21-8014 7"
21-8016 9"



**T-C NEW ORLEANS
NEEDLE HOLDER**

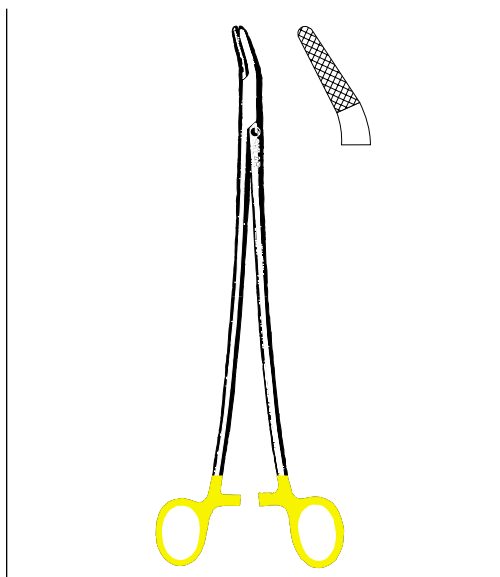
21-8080 7" Serrated

TUNGSTEN CARBIDE NEEDLE HOLDERS



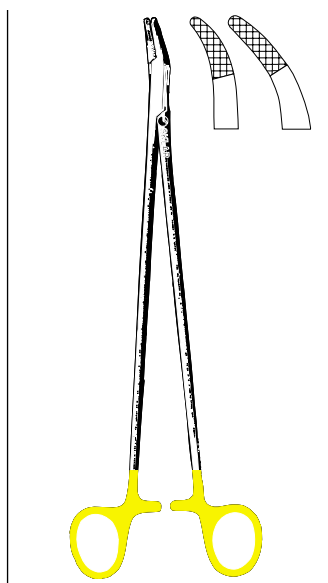
T-C OLSEN-HEGAR NEEDLE HOLDERS

21-8025	4 ³ / ₄ "	Serrated	Delicate
21-8027	5 ¹ / ₂ "	Serrated	
21-8028	6 ¹ / ₂ "	Serrated	
21-8029	7 ¹ / ₂ "	Serrated	
21-8026	4 ³ / ₄ "	Smooth	Delicate



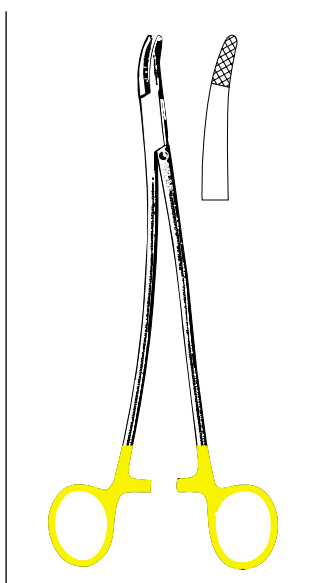
T-C HEANEY NEEDLE HOLDER

Curved			
21-8060	8 ¹ / ₂ "	Serrated	
21-8061	10"	Serrated	



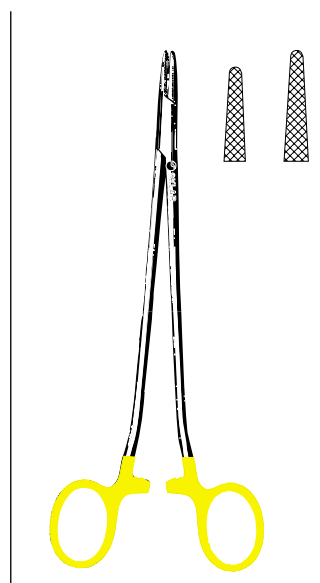
T-C FINOCHIETTO NEEDLE HOLDER

Angular			
21-8038	8 ¹ / ₂ "	Serrated	
21-8039	10 ¹ / ₂ "	Serrated	



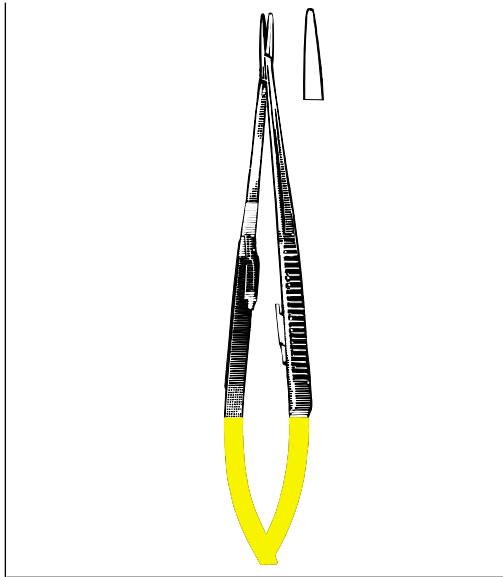
T-C STRATTE NEEDLE HOLDER

"S" Shaped			
21-8065	9"	Serrated	



T-C SAROT NEEDLE HOLDER

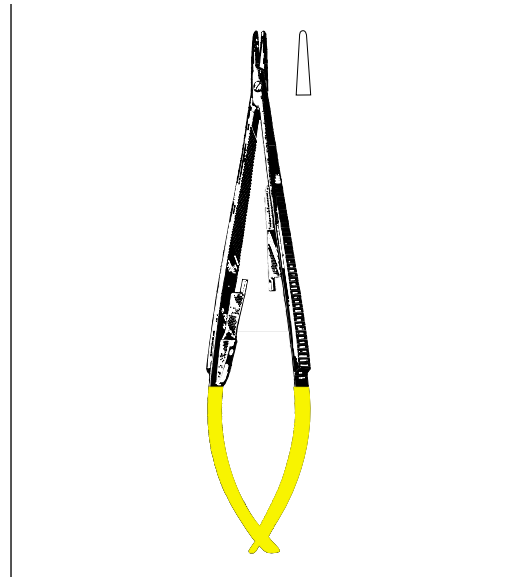
21-8036	7 ¹ / ₈ "	Serrated	
21-8037	10 ¹ / ₂ "	Serrated	



T-C JACOBSON NEEDLE HOLDER

Straight-Delicate

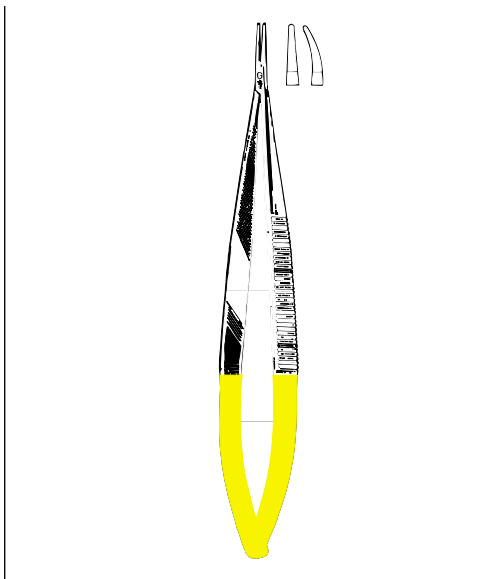
21-8055 7¼" Smooth
21-8058 8½" Smooth w/out lock



T-C CASTROVIEJO NEEDLE HOLDER

Standard-With Lock Straight

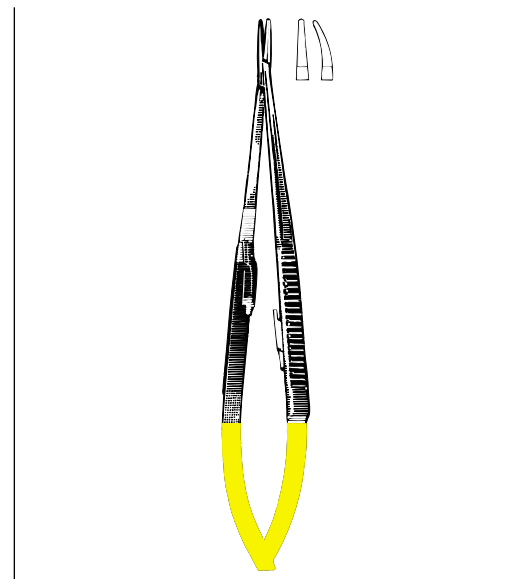
21-8040 5½" Smooth
21-8046 5½" Serrated



T-C CASTROVIEJO NEEDLE HOLDER

Extra Delicate-Without Lock

21-8044 5½" Straight, Smooth
21-8045 5½" Curved, Smooth



T-C CASTROVIEJO NEEDLE HOLDER

Extra Delicate-With Lock

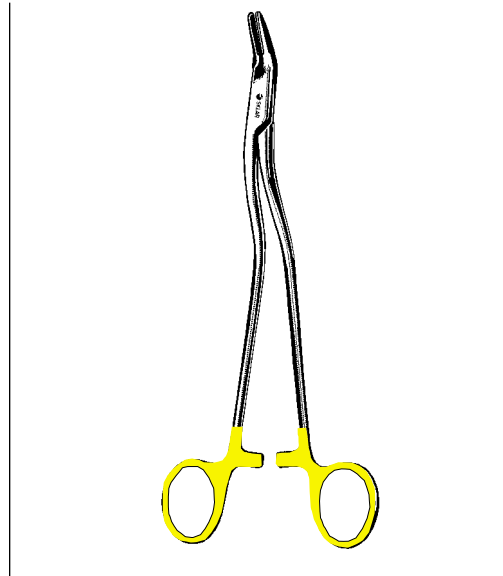
21-8042 5½" Straight, Smooth
21-8043 5½" Curved, Smooth

TUNGSTEN CARBIDE NEEDLE HOLDERS



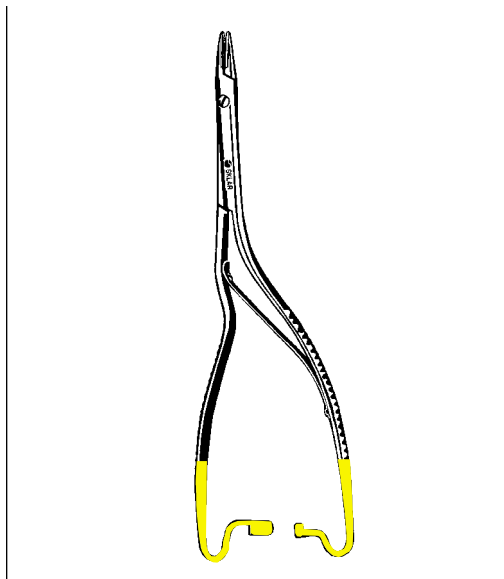
T-C MATHIEU NEEDLE HOLDER

21-8070 5½"
21-8071 6¾" Narrow Jaw



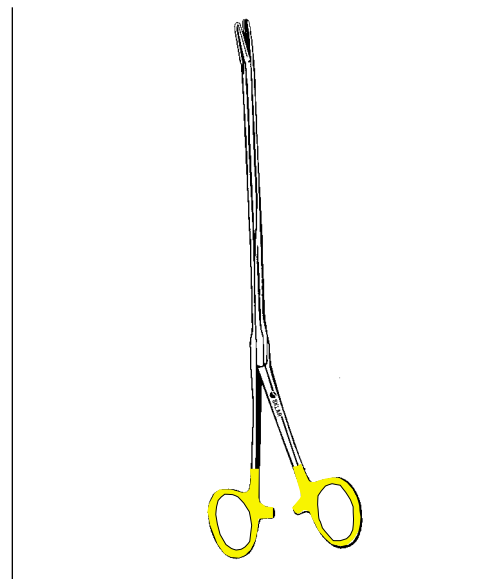
T-C BOZEMAN-HEANEY NEEDLE HOLDERS

21-8062 10½" Curved



T-C LUETHY BECK NEEDLE HOLDER

21-8064 8"



T-C ALLIGATOR ACTION NEEDLE HOLDER

21-8078 9¼" Anastomosis

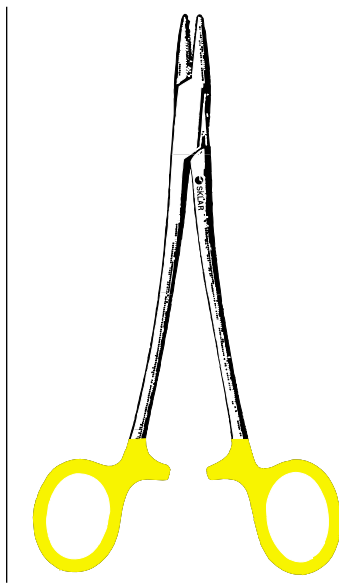
Sklar's Left-Handed Needle Holders

Now there's a ring-handled needle holder created for the needs of left-handed surgeons.

Sklar's left-handed needle holder features a unique ratchet design that makes it possible for surgeons to easily control the needle holder with their left hand. As a result surgeons experience less fatigue and hand strain than ever before.

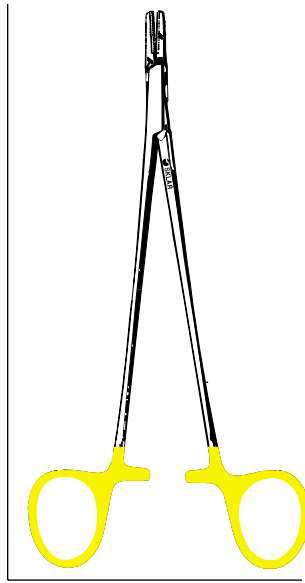


Suitable for Left Hand Use



**T-C INSERT MAYO-HEGAR
NEEDLE HOLDER**

Serrated (Left Handed)
21-9016 Mayo-Hegar 6"
21-9018 Mayo-Hegar 7"



**T-C INSERT RYDER
NEEDLE HOLDER**

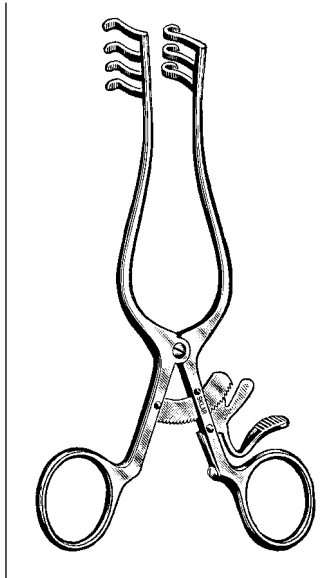
Serrated (Left Handed)
21-9045 Ryder French Eye 6"



**T-C INSERT CRILE-WOOD
NEEDLE HOLDER**

Serrated (Left Handed)
21-9030 Crile-Wood 6"
21-9035 Crile-Wood 7"

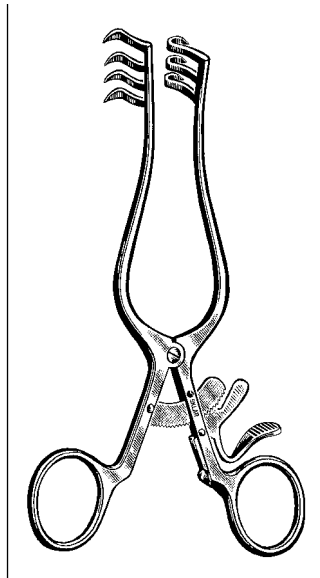
RETRACTORS



WEITLANER SELF-RETAINING RETRACTOR

Tru-Grip Ratchet With Fingerguard
Blunt

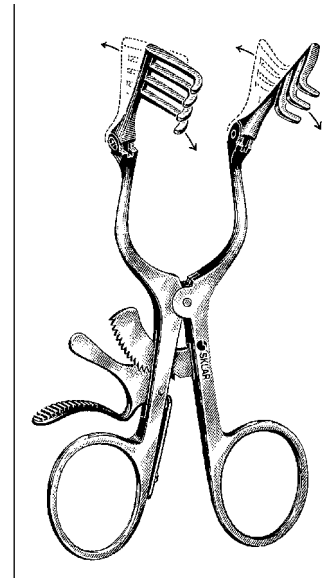
22-8345	4½"	2 x 3 Teeth
22-8355	5½"	3 x 4 Teeth
42-1865	6½"	3 x 4 Teeth
42-1875	8"	3 x 4 Teeth
42-1895	9½"	3 x 4 Teeth



WEITLANER SELF-RETAINING RETRACTOR

Tru-Grip Ratchet With Fingerguard
Sharp

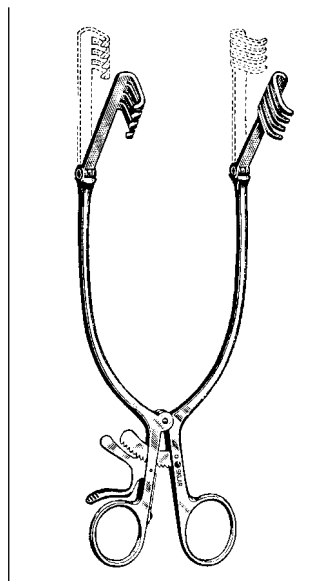
22-8245	4½"	2 x 3 Teeth
22-8255	5½"	3 x 4 Teeth
42-1965	6½"	3 x 4 Teeth
42-1975	8"	3 x 4 Teeth
42-1995	9½"	3 x 4 Teeth



WEITLANER-BECKMAN RETRACTOR

Hinged Blades

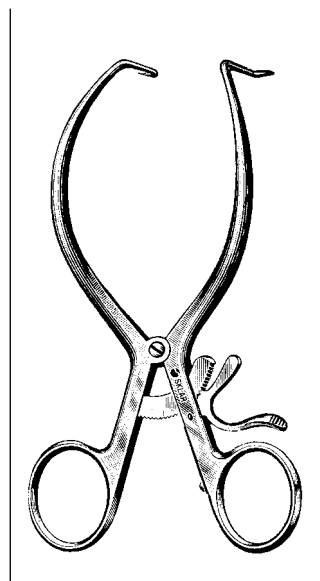
42-1655	6"	Blunt
42-1765	6"	Sharp



ADSON RETRACTOR

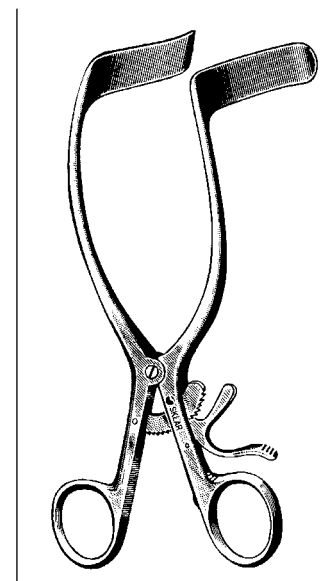
Tru-grip ratchet

42-1511	12"	Blunt
42-1611	12"	Sharp



GELPI RETRACTOR

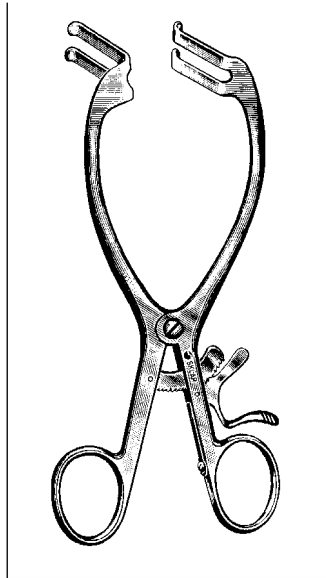
22-8850	3½"	
22-8853	5½"	
22-8855	6¼"	
60-6570	7"	
60-6575	10"	Special extra long and extra wide



RIGBY RETRACTOR

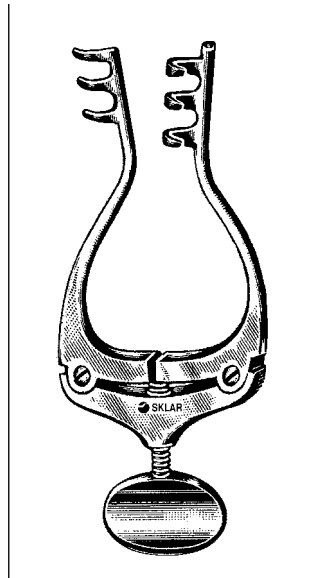
Tru-grip ratchet

60-6370	7"	
---------	----	--



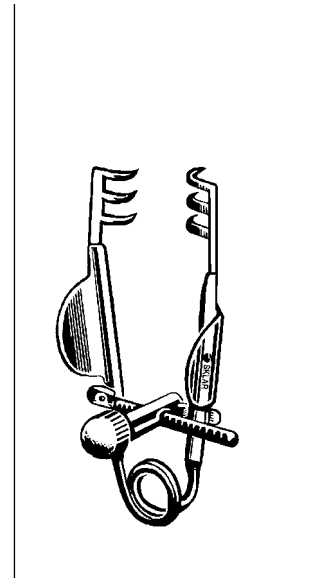
**MAYO-ADAMS
RETRACTOR**

Tru-grip ratchet
60-6467 6 1/2" 2 Blades



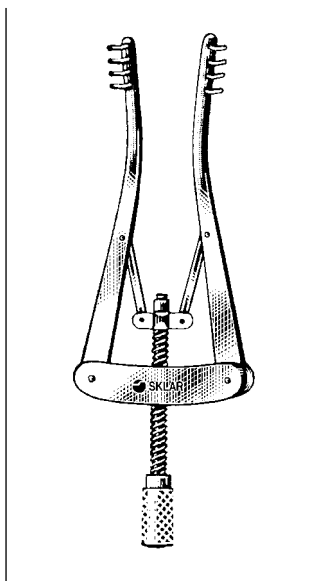
**JANSEN SELF-RETAINING
RETRACTOR**

3 x 3 Blades
47-2832 4" Blunt



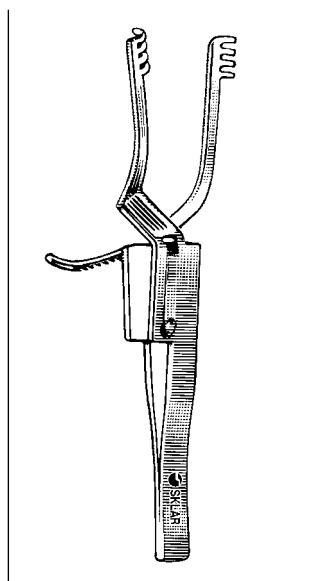
**SELF RETAINING
RETRACTOR**

Delicate
65-1815 3 Sharp Prongs 1 1/2"



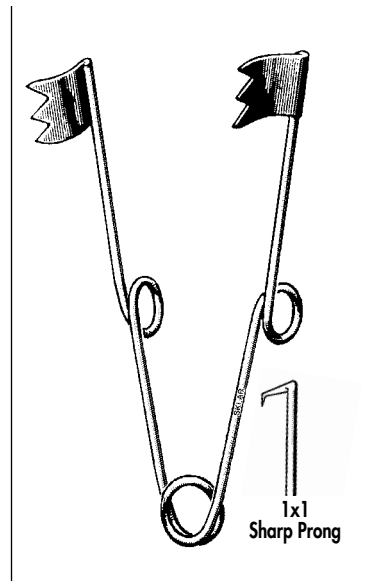
**ALM SELF-RETAINING
RETRACTOR**

22-9027 2 3/4" 4 x 4 Teeth Blunt
60-6340 4" 4 x 4 Teeth Blunt



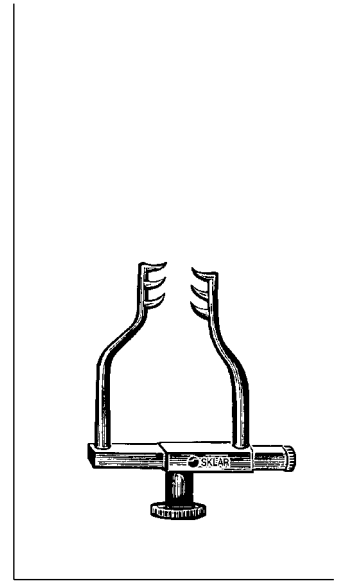
**HOLZHEIMER
SELF-RETAINING
RETRACTOR**

Sharp
22-8920 4" 4 x 4 Teeth
Blunt
22-8940 4" 4 x 4 Teeth



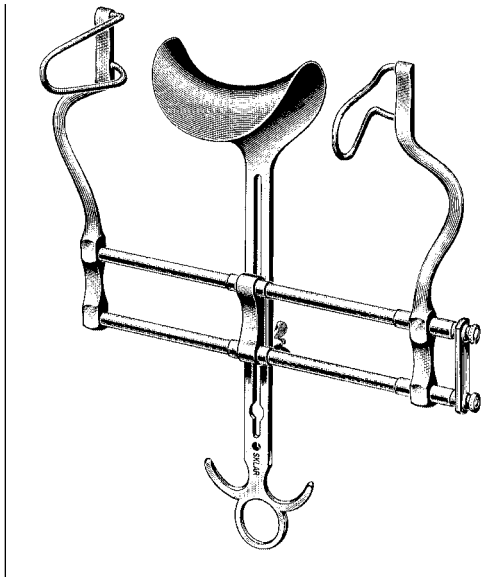
**WIRE RETAINING
RETRACTOR**

Small
22-8832 3 1/4" 3x3 Blade
22-8834 3 1/4" 1x1 Sharp Prong



GOLDSTEIN RETRACTOR

47-2913 1 3/8" Sharp



BALFOUR RETRACTOR

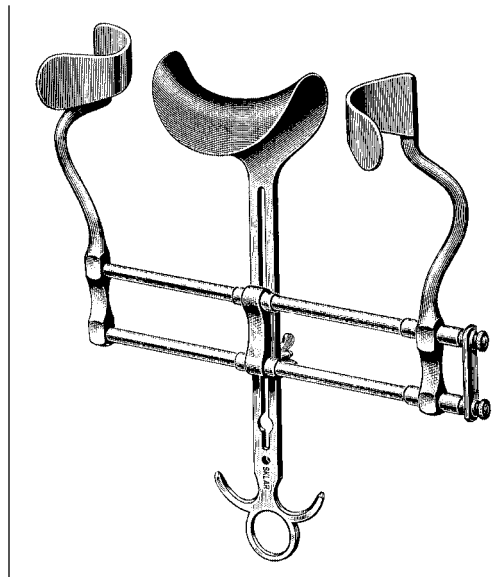
Fenestrated End blades

60-6670 2" deep 7" spread

60-6710 2" deep 10" spread

Pediatric

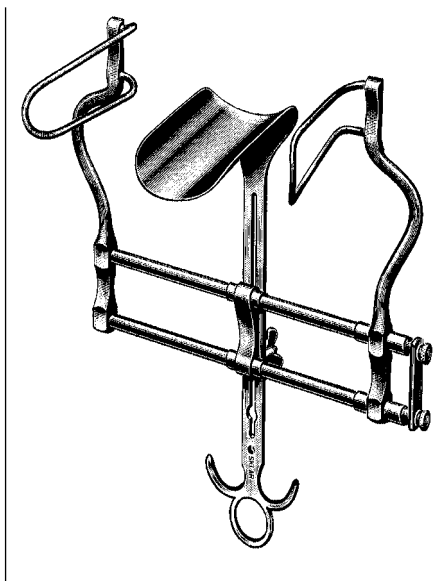
22-9030 1 1/4" deep 4" spread



BALFOUR RETRACTOR

Solid End blades

60-6870 2" deep 7" spread

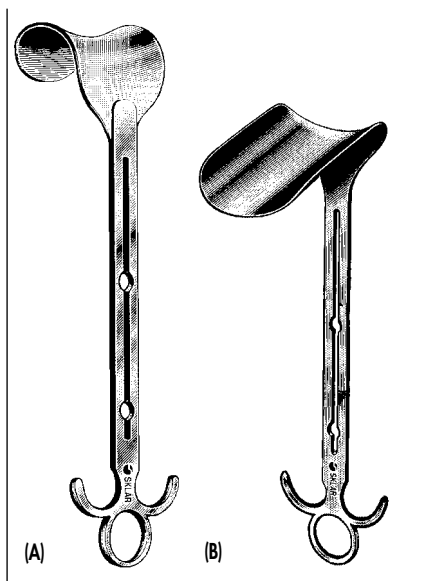


BALFOUR RETRACTOR

Fenestrated

60-7070 4" deep 7" spread

60-7110 4" deep 10" spread

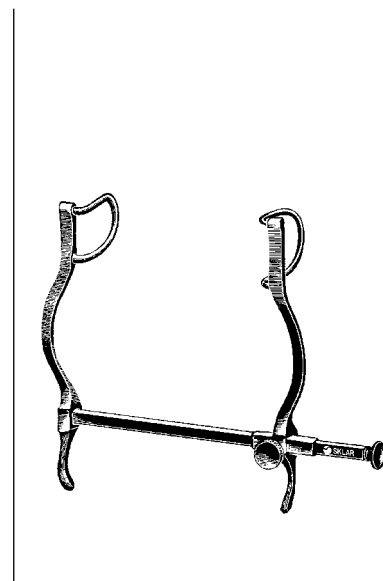


BALFOUR CENTER BLADE

60-7120 1 3/4" wide x 3" deep (A)

60-7125 2 1/2" wide x 3" deep (A)

60-7130 2 1/2" wide x 4" deep (B)

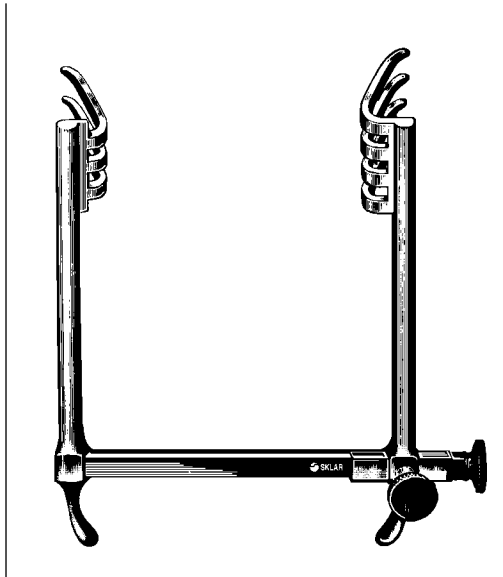


NELSON RETRACTOR (GOSSET)

Self-retaining

55-7355 1" x 2 1/2" blades 5 1/2" spread

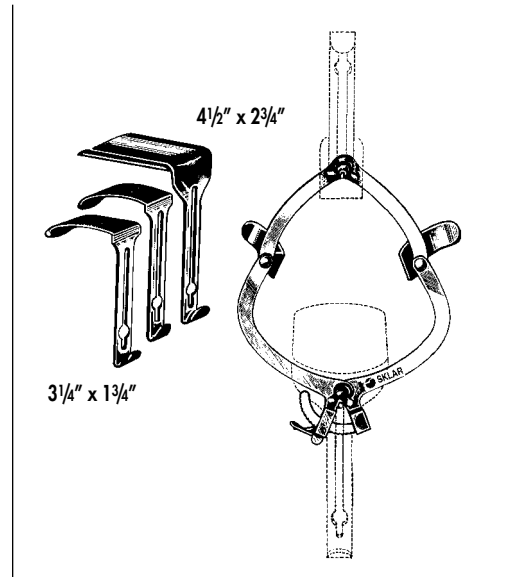
60-6240 3/4" x 1 1/2" blades 4" spread



TEMPLE-FAY RETRACTOR

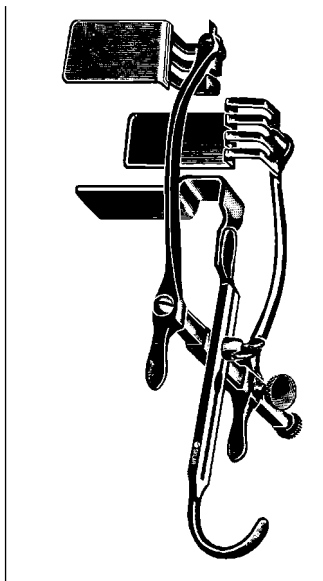
Total Opening 4 $\frac{3}{4}$ "

42-1247 4 Prong Blade 1 $\frac{1}{2}$ " x 2"
3 Prong Blade 1" x 2"



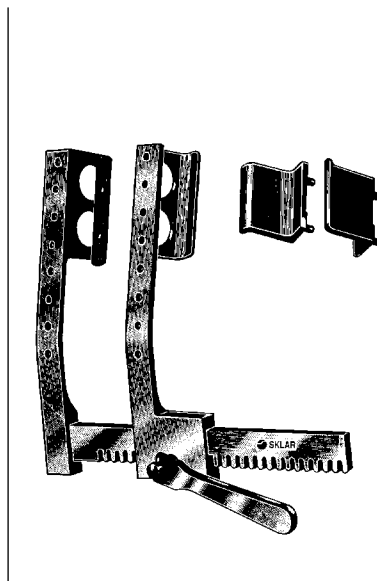
O'SULLIVAN-O'CONNOR ABDOMINAL RETRACTOR

90-3025 With 3 interchangeable blades
2 large, 1 small



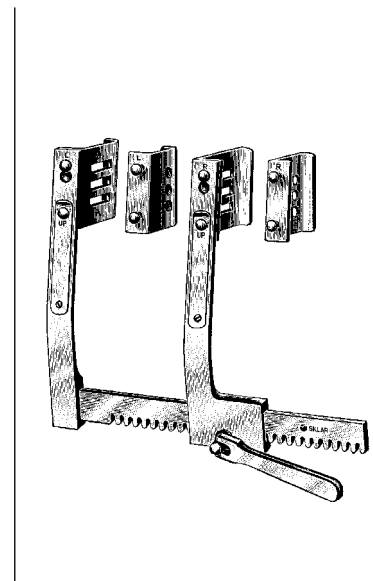
SKLAR RETRACTOR

85-5350 Bladder and Suprapubic
Retractor, with 2 blades
85-5346 Extra center blade



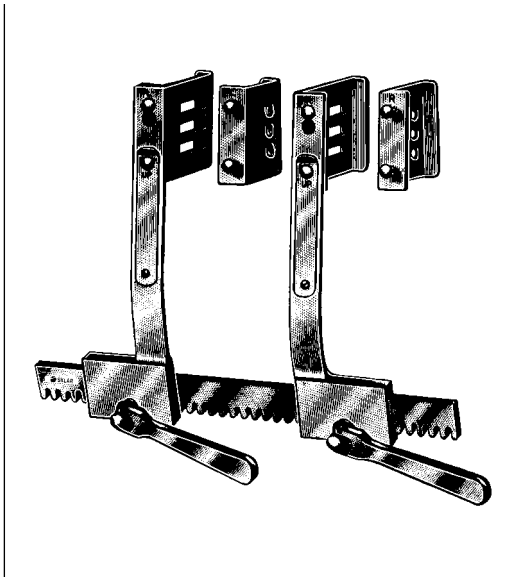
HARKEN RIB SPREADER

55-7785 1 $\frac{3}{4}$ " deep x 3" wide, solid
scapula blades, 1 $\frac{1}{2}$ " deep x
2" wide, total opening 8 $\frac{1}{2}$ "



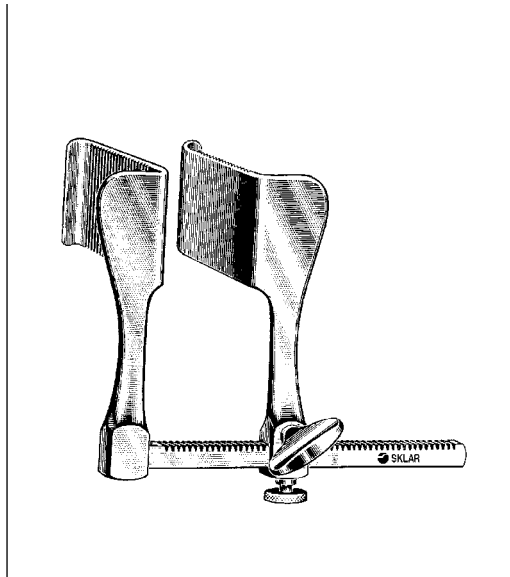
BURFORD-FINOCHIETTO RIB SPREADER

2 sets of blades
55-7880 2 $\frac{1}{2}$ " x 2 $\frac{1}{2}$ " 8" spread
1 $\frac{1}{2}$ " x 2 $\frac{1}{2}$ "



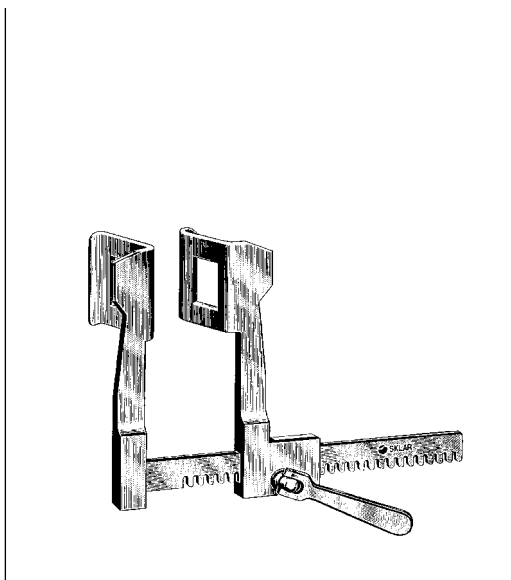
BURFORD-FINOCHIETTO RIB SPREADER

55-7980 With both arms movable and two sets of interchangeable blades, large, 2½" x 2½" (6.4 x 7 cm), small, 1½" x 2½" (6.4 x 5.1 cm), curved arms, total opening 8" (20.3 cm)



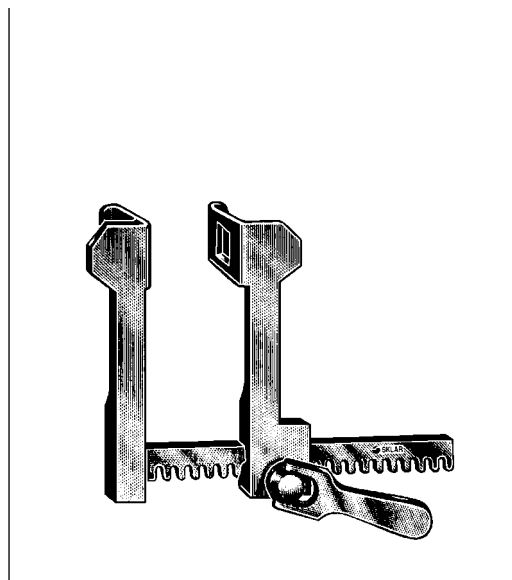
TUFFIER RIB SPREADER

55-7445 2" x 2" 4½" Spread
55-7465 2" x 2" 6½" Spread



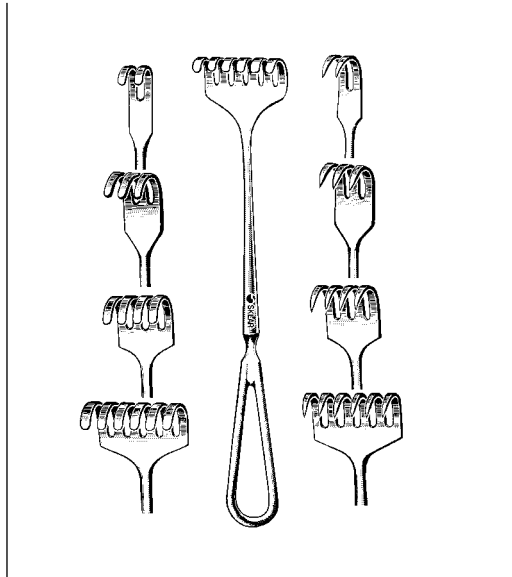
FINOCHIETTO RIB SPREADER

55-7675 1¼" x 1½" 6" Spread
55-7685 1¾" x 2½" 6½" Spread



HAIGHT-FINOCHIETTO RIB RETRACTOR

22-7855 Total opening 3"



VOLKMAN RETRACTOR (USA)

8½" Length

Sharp

60-5602 2 pr
60-5603 3 pr
60-5604 4 pr
60-5606 6 pr

Blunt

60-5502 2 pr
60-5503 3 pr
60-5504 4 pr
60-5506 6 pr

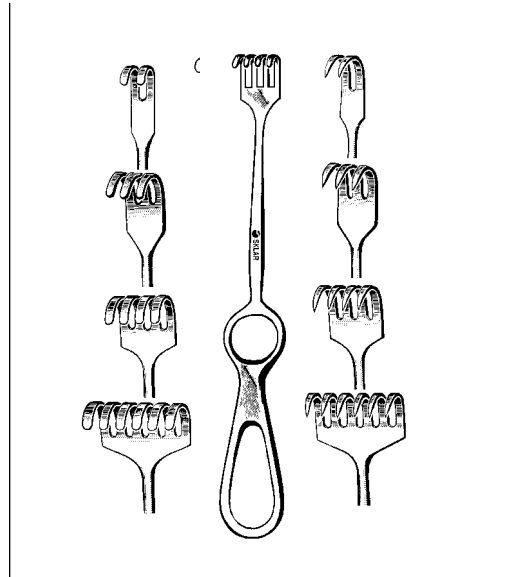
4½" length

Sharp

60-4242 2 pr
60-4243 3 pr
60-4244 4 pr
60-4246 6 pr

Blunt

60-4252 2 pr
60-4253 3 pr
60-4254 4 pr
60-4256 6 pr



VOLKMAN RETRACTOR (RING HANDLE)

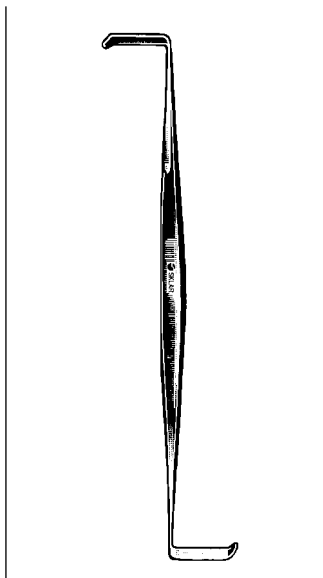
8½" Length

Sharp

60-5822 2 pr
60-5823 3 pr
60-5824 4 pr
60-5826 6 pr

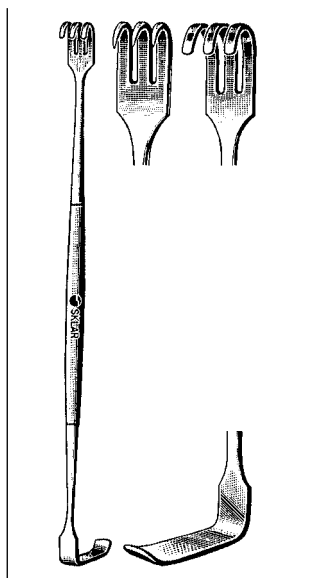
Blunt

60-5812 2 pr
60-5813 3 pr
60-5814 4 pr
60-5816 6 pr



HERNIA RETRACTOR

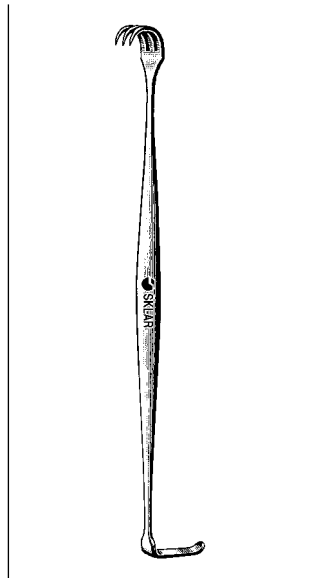
Double Ended
22-8860 6"



SENN RETRACTOR

Double Ended

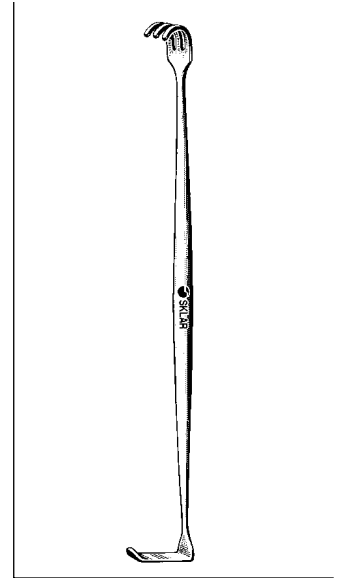
60-6162 6¼" Sharp
60-6164 6¼" Blunt



MILLER-SENN RETRACTOR

Double Ended

22-8360 6" Sharp
Solid End 5 mm x 18 mm
22-8460 6" Blunt
Solid End 5 mm x 18 mm

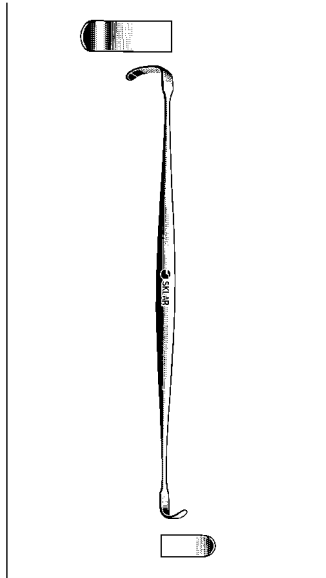


MATHIEU RETRACTOR

Double Ended

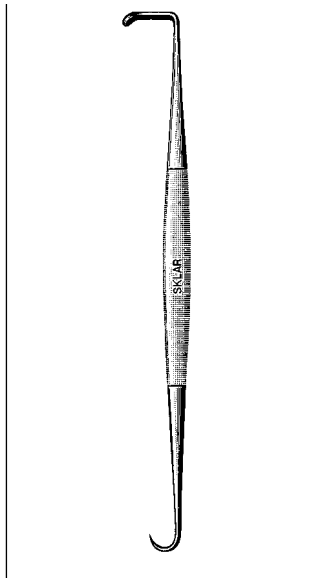
60-6062 6¼" Blunt

RETRACTORS



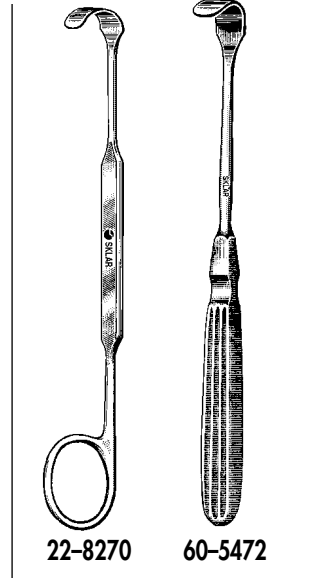
RAGNELL RETRACTOR

Double End
22-8560 5½"



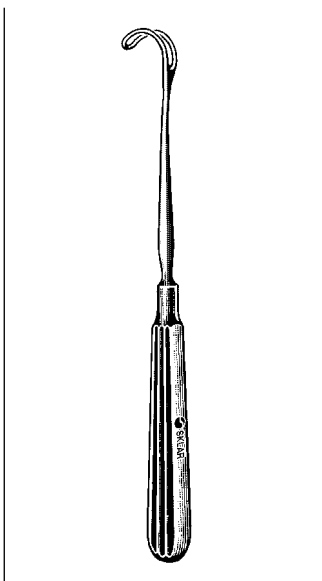
MEYERDING SKIN HOOK AND RETRACTOR

Double End
47-2462 6¼"



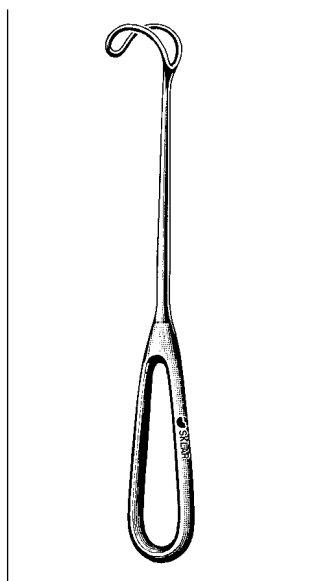
LITTLE RETRACTOR

X-thin blade
22-8270 ½" x 7" Ring Handle
60-5472 ½" x 7¼"



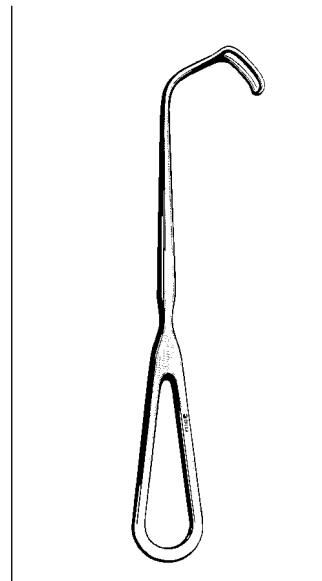
McBURNAY RETRACTOR

Fenestrated
57-1475 ⅝" x 7½"



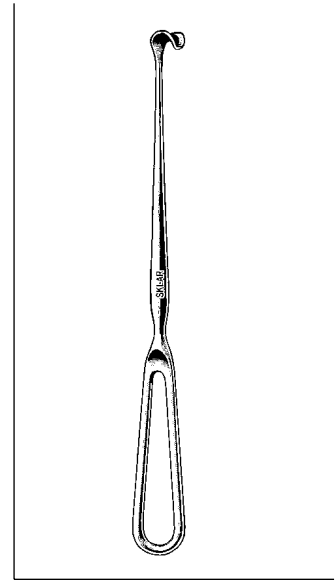
GREEN RETRACTOR

Fenestrated
57-1485 ⅝" x 8½"



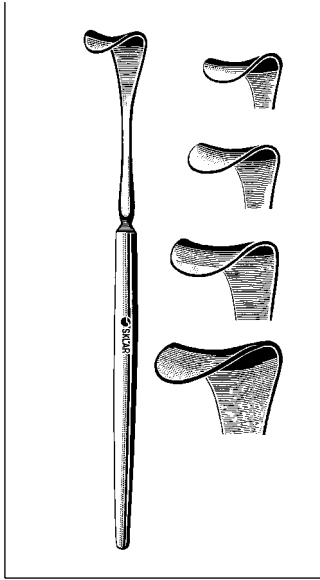
SKLAR FENESTRATED RETRACTOR

50-1280 8"



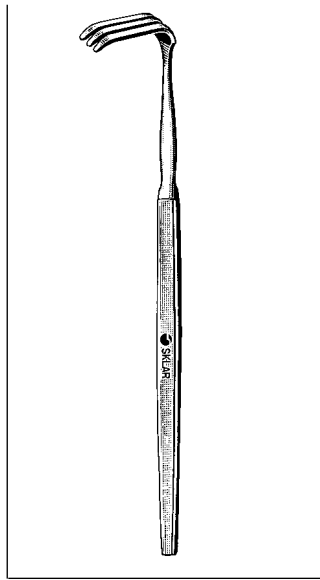
CUSHING VEIN RETRACTOR

50-1290 9"



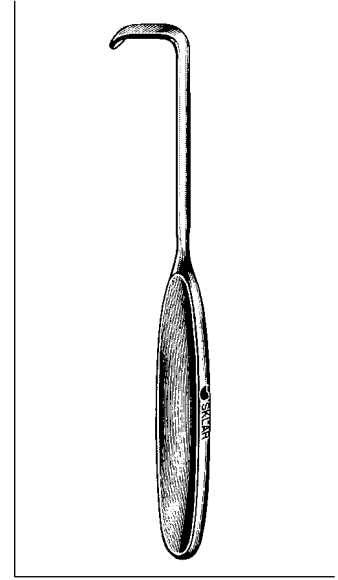
**DESMARRES LID
RETRACTOR**

65-1841	#1	5½"
65-1842	#2	5½"
65-1843	#3	5½"
65-1844	#4	5½"



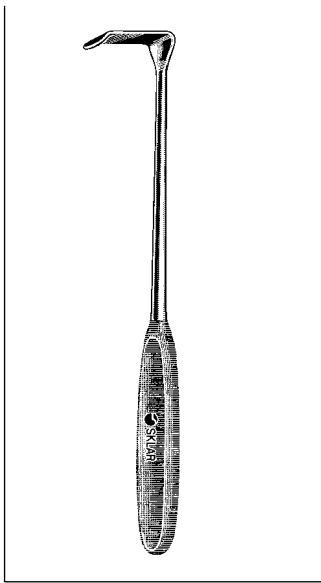
PAUL RETRACTOR

47-2647 4¾" 3 Prong Blunt



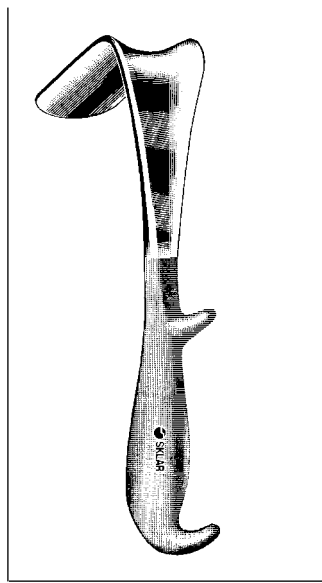
LAHEY RETRACTOR

52-1277 7"



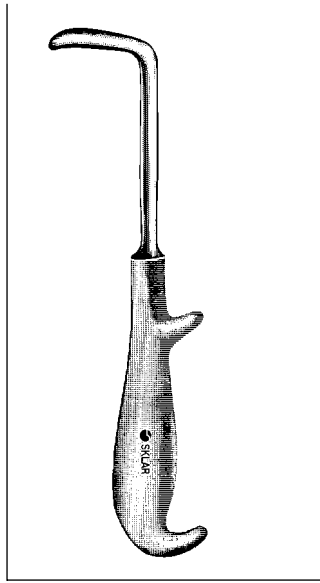
**LANGENBECK
RETRACTOR**

60-1891	¾" x 1½"	9"
60-1892	½" x 1¼"	9"
60-1893	⅝" x 1¼"	9"



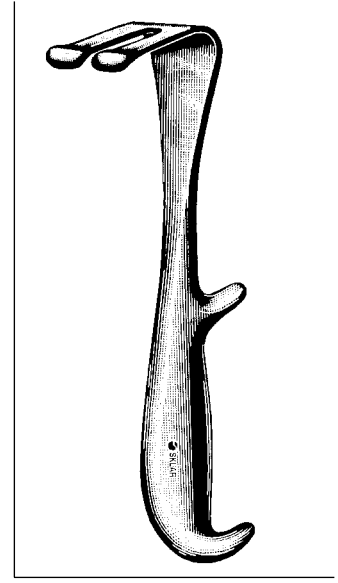
**YOUNG ANTERIOR
RETRACTOR**

85-4780 8"



**YOUNG LATERAL
RETRACTOR**

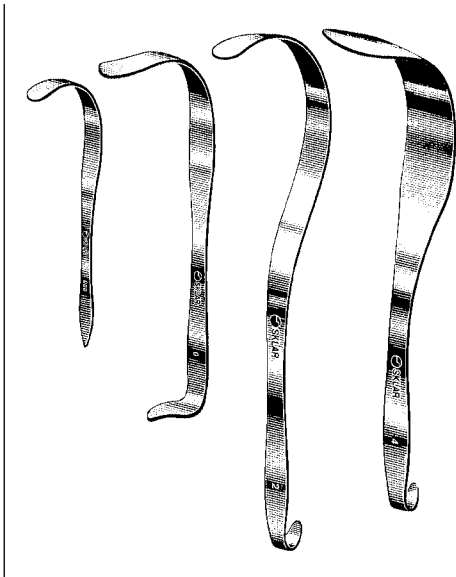
85-4697 8½"



**YOUNG BIFURCATED
RETRACTOR**

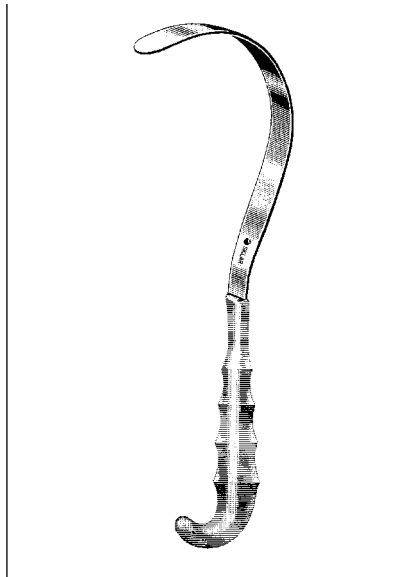
85-4970 8½"

RETRACTORS



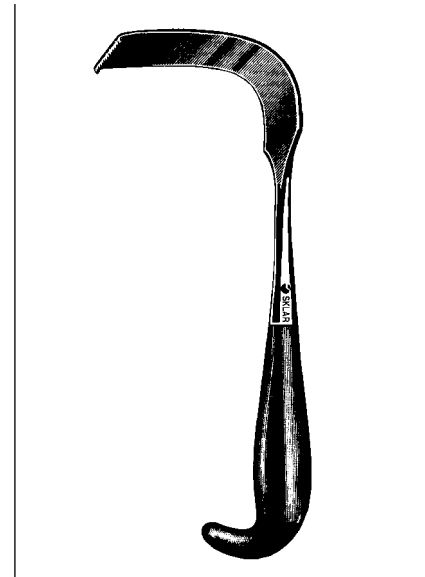
DEAVER RETRACTOR WITHOUT HANDLE

60-3070 #000	3/4" x 7"	60-3114 #2½	1" x 14"
60-3085 #00	7/8" x 8½"	60-3212 #3	1½" x 12"
60-3090 #0	1" x 9"	60-3312 #4	2" x 12"
60-3112 #1	1" x 12"	60-3412 #5	3" x 12"
60-3113 #2	1" x 13"	60-3440	4" x 12"
Pediatric			
22-8080	5/8" x 8"	22-8180	1" x 8"



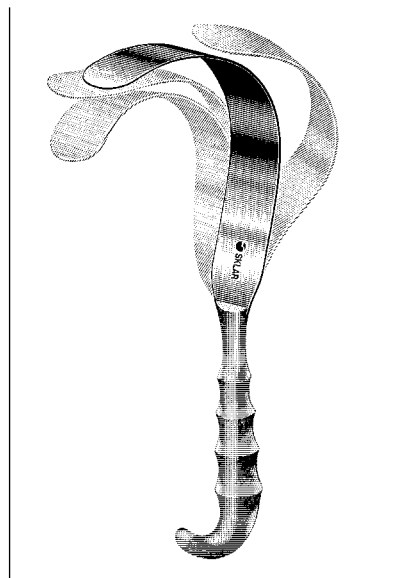
DEAVER RETRACTOR SKLAR-GRIP HANDLE

60-2710 #0	1" x 10"	60-2812 #3	1½" x 12"
60-2712 #1	1" x 12"	60-2912 #4	2" x 12"
60-2713 #2	1" x 13"	60-3012 #5	3" x 12"
60-2714 #2½	1" x 14½"		



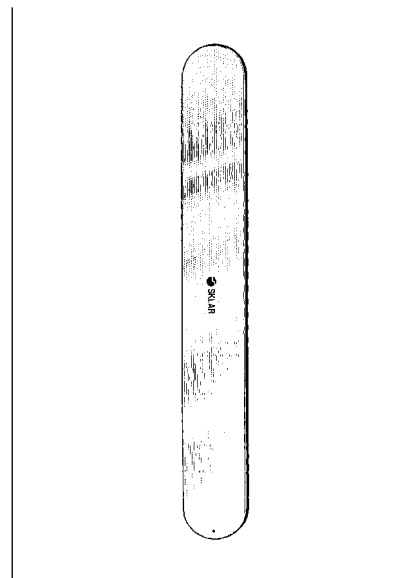
MEYERDING RETRACTOR

42-2092 9¼" Medium



ZALKIND LUNG RETRACTOR

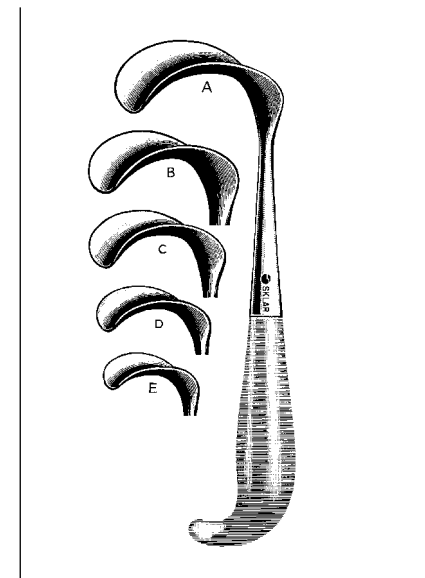
Malleable
55-7220 2" x 12"
55-7230 3" x 12"



ZALKIND (RIBBON) RETRACTOR

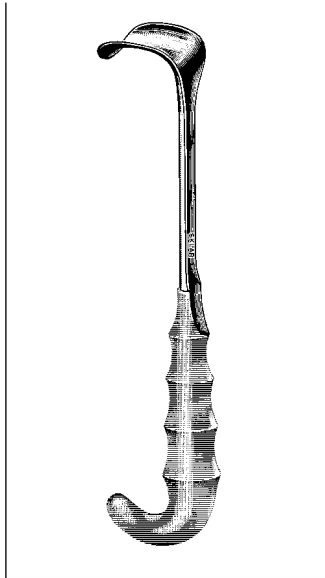
Malleable

60-3594	¼" x 7"	60-3607	¼" x 13"
60-3596	½" x 7"	60-3610	1" x 13"
22-8067	¾" x 7"	60-3612	1¼" x 13"
60-3598	¾" x 7"	60-3615	1½" x 13"
22-8075	1" x 7"	60-3617	1¾" x 13"
		60-3620	2" x 13"
		60-3625	2½" x 13"



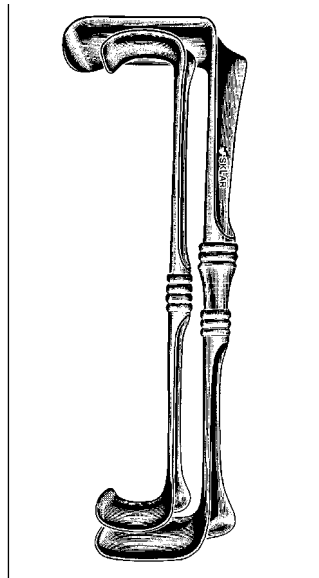
BREWSTER RETRACTOR

60-5431	Style 'A'	2½" x 17½"
60-5432	Style 'B'	2¼" x 1¾"
60-5433	Style 'C'	2" x 1¾"
60-5434	Style 'D'	1¾" x 1"
60-5435	Style 'E'	¾" x 1½"



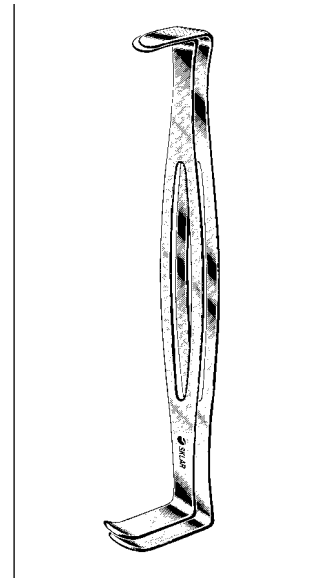
RICHARDSON RETRACTOR

60-1676 $\frac{3}{4}$ " x 1" 9 $\frac{1}{2}$ "
 60-1681 1" x 1 $\frac{1}{4}$ " 9 $\frac{1}{2}$ "
 60-1686 1 $\frac{1}{2}$ " x 1 $\frac{1}{2}$ " 9 $\frac{1}{2}$ "
 60-1691 $\frac{3}{4}$ " x 2" 9 $\frac{1}{2}$ "



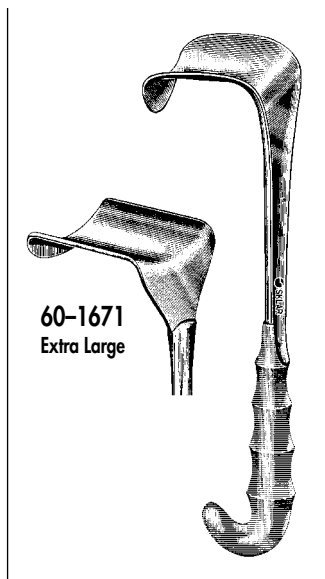
RICHARDSON- EASTMAN RETRACTOR

Double end
 60-1697 $1\frac{5}{8}$ " x 2 $\frac{1}{2}$ "
 $1\frac{1}{2}$ " x 1 $\frac{3}{4}$ " 10 $\frac{1}{4}$ "
 60-1699 $\frac{3}{4}$ " x 1 $\frac{1}{8}$ "
 $1\frac{1}{8}$ " x 1 $\frac{1}{2}$ " 9 $\frac{1}{2}$ "
 60-1695 Set of 2 above



U.S. ARMY PATTERN RETRACTOR

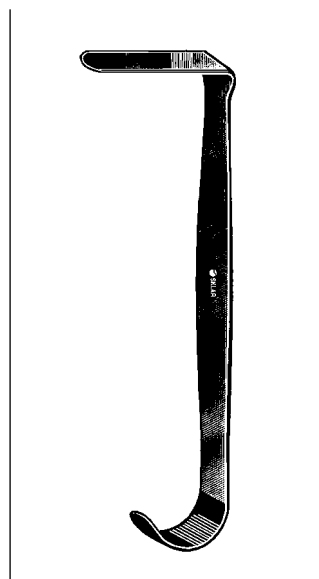
Set of 2
 60-1085 8 $\frac{1}{2}$ "



60-1671
 Extra Large

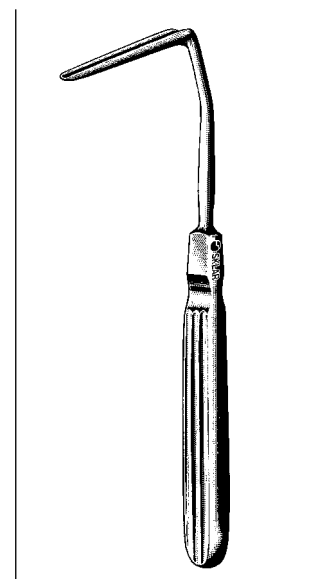
KELLY RETRACTOR

60-1656 9" 1 $\frac{1}{2}$ " x 2"
 60-1661 9 $\frac{1}{2}$ " 2" x 2 $\frac{1}{2}$ "
 60-1666 10" 2 $\frac{1}{2}$ " x 3"
 60-1671 10 $\frac{1}{2}$ " 2 $\frac{3}{4}$ " x 3 $\frac{1}{4}$ "
 Extra Large



HEANEY RETRACTOR

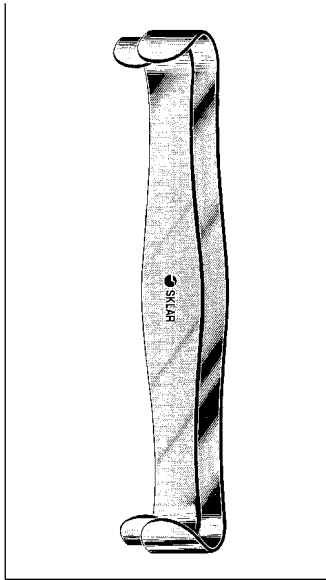
60-1616 10 $\frac{1}{2}$ " Small Blade
 $1\frac{3}{4}$ " x 1"
 60-1617 10 $\frac{1}{2}$ " Medium Blade
 $2\frac{7}{8}$ " x 1 $\frac{1}{8}$ "
 60-1618 10 $\frac{1}{2}$ " Large Blade
 $3\frac{1}{4}$ " x 1 $\frac{1}{8}$ "



AUFRECHT RETRACTOR

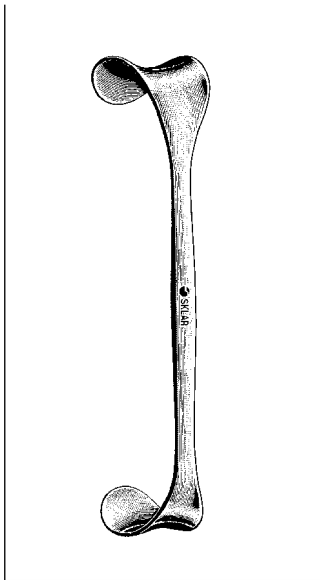
Solid blade
 41-1410 7 $\frac{1}{4}$ " x 1 $\frac{3}{4}$ "

RETRACTORS



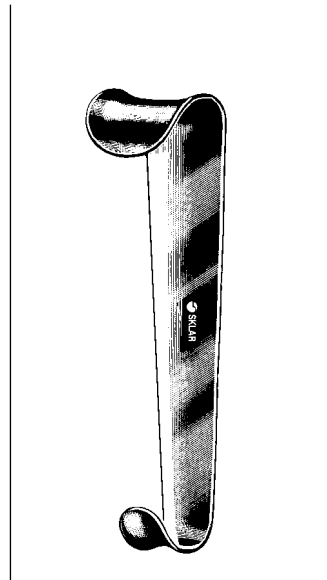
PARKER RETRACTOR

Double End Set of 2
 60-1350 $\frac{5}{8}$ " x 5"
 60-1370 1" x 7"



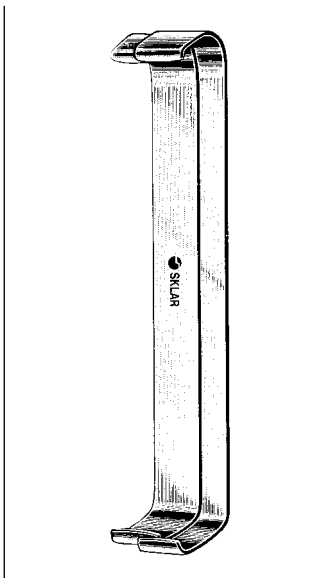
GOELET RETRACTOR

Double End
 60-1075 7 $\frac{1}{2}$ " Long 1 $\frac{1}{4}$ " x 1 $\frac{1}{2}$ "



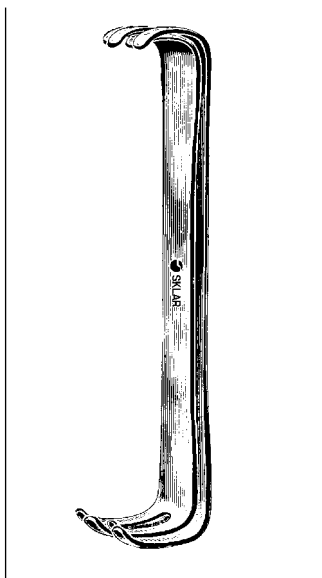
ROUX RETRACTOR

60-1170 5 $\frac{1}{4}$ " Long $\frac{3}{4}$ " x 1"
 Double End, Small



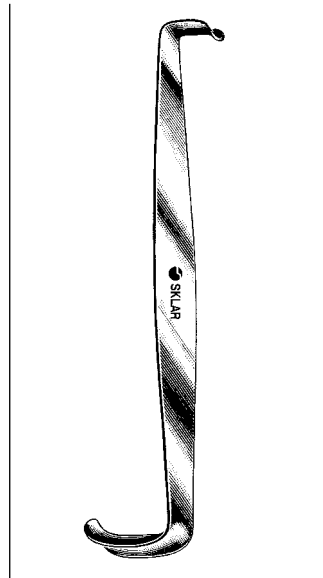
FARABEUF RETRACTOR

Double End Set of 2
 60-1460 6" $\frac{5}{8}$ " x 7 $\frac{1}{8}$ " $\frac{5}{8}$ " x 1"



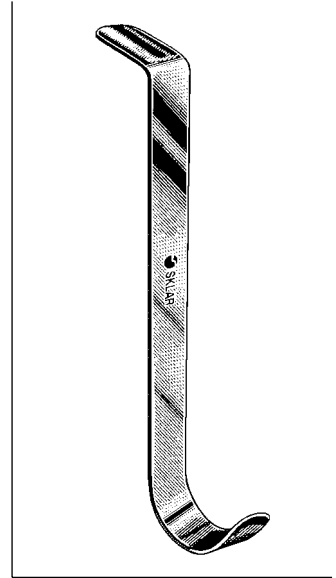
MAYO-COLLINS FORCEPS

Double End Set of 2
 60-1160 6" $\frac{3}{4}$ " x 1 $\frac{1}{2}$ "



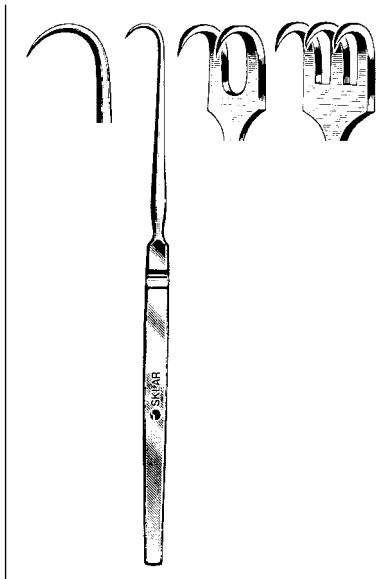
CRILE RETRACTOR

Double End
 57-1445 Small 4 $\frac{1}{2}$ "



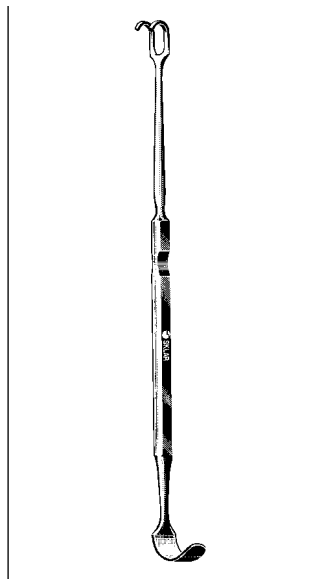
CONVERSE RETRACTOR

41-1402 3 $\frac{3}{4}$ " #2 12mm x 25mm
 41-1403 3 $\frac{3}{4}$ " #3 12mm x 40mm



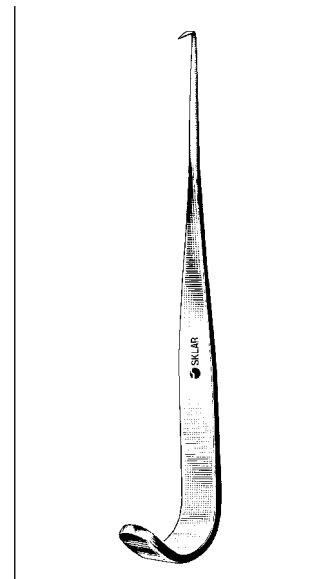
TRACHEAL RETRACTOR

- 6½"
- 78-1001 Sharp 1 prong
 - 78-1002 Sharp 2 prong
 - 78-1003 Sharp 3 prong
 - 78-1101 Blunt 1 prong
 - 78-1102 Blunt 2 prong
 - 78-1103 Blunt 3 prong



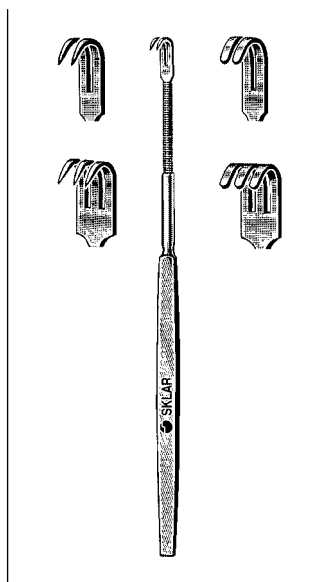
JACKSON TRACHEAL RETRACTOR

- Blunt Double Prong
- 78-3570 7"



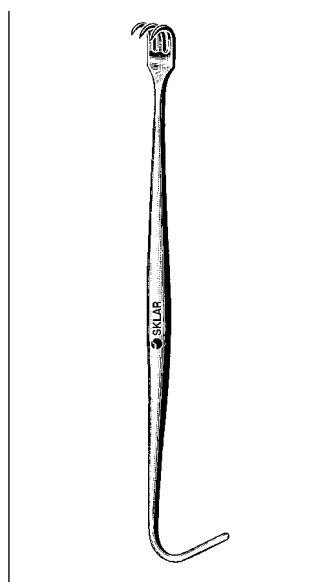
JACKSON TENACULUM

- 78-3550 5¾"



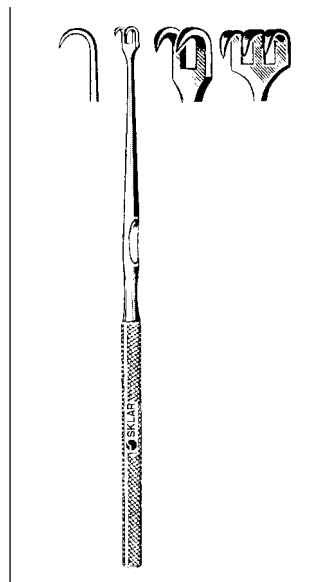
PLASTIC SURGERY RETRACTOR

- 6"- Flexible Shank
- 22-9132 Sharp 2 Prong
 - 22-9133 Sharp 3 Prong
 - 22-9142 Blunt 2 Prong
 - 22-9143 Blunt 3 Prong



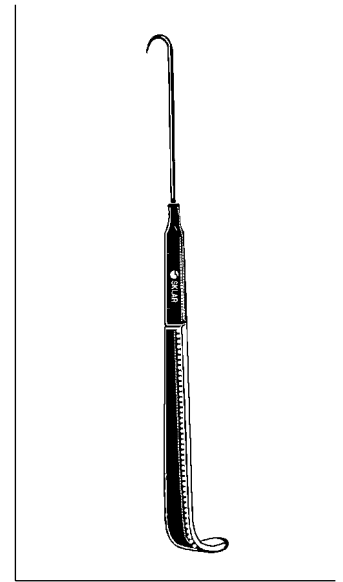
HUPP TRACHEAL RETRACTOR

- Double End
- 78-1113 6" with 3 sharp prongs and blunt hook



LAHEY RETRACTOR

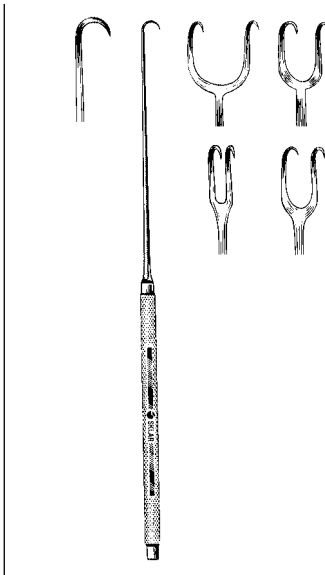
- 4¾" Sharp
- 78-1201 1 Prong
- 78-1202 2 Prong
- 78-1203 3 Prong



NEWS HOOK

- 78-3545 6"

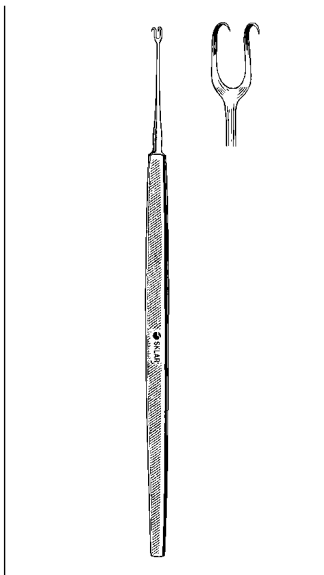
RETRACTORS



JOSEPH SKIN HOOK

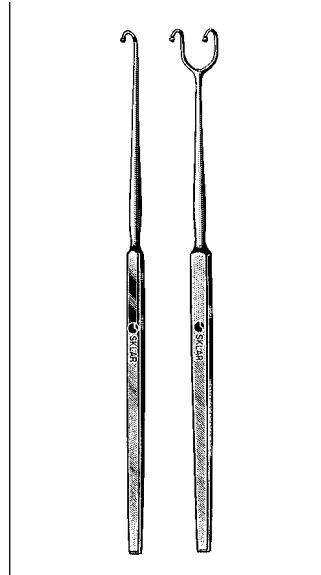
Single End

- 47-2500 6¼" 1 Sharp Prong
- 47-2502 6¼" 2 Prong 2 mm
- 47-2505 6¼" 2 Prong 5 mm
- 47-2507 6¼" 2 Prong 7 mm
- 47-2510 6¼" 2 Prong 10 mm



GUTHRIE DOUBLE HOOK

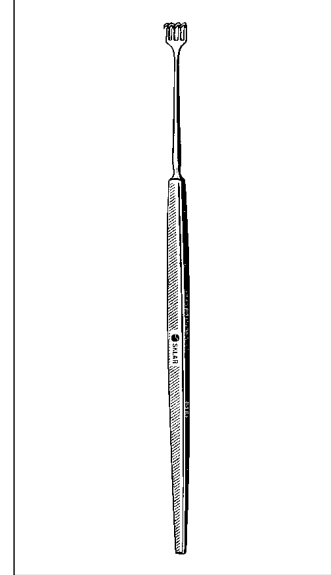
- 47-2650 5" Sharp



FOMON RETRACTOR

Ball End

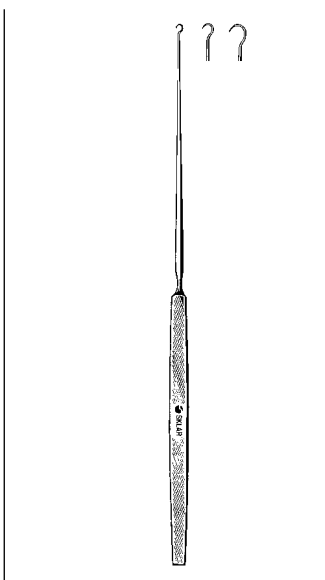
- 41-1395 6¼" Single
- 41-1396 6¼" Double



BLAIR (ROLLET) RETRACTOR

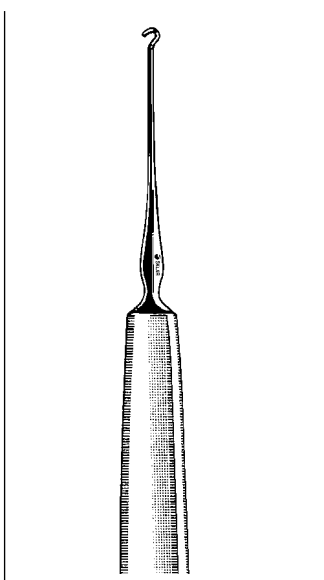
4 Prong-Delicate

- 47-2655 5½" Sharp
- 47-2752 5½" Blunt



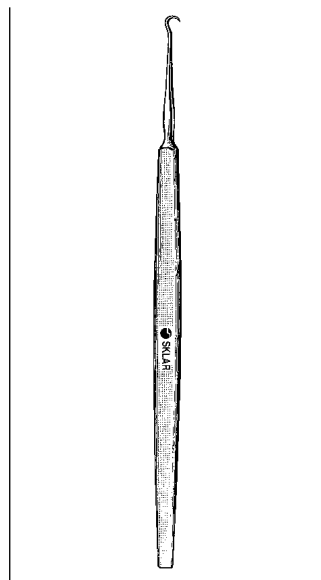
GILLIES SKIN HOOK

- 47-2570 7" 3 mm
- 47-2572 7" 4 mm



TYRELL IRIS HOOK

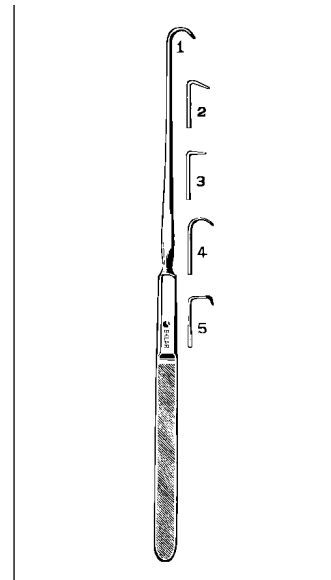
- 65-3205 Blunt
- 65-3206 Sharp



FRAZIER TISSUE HOOK

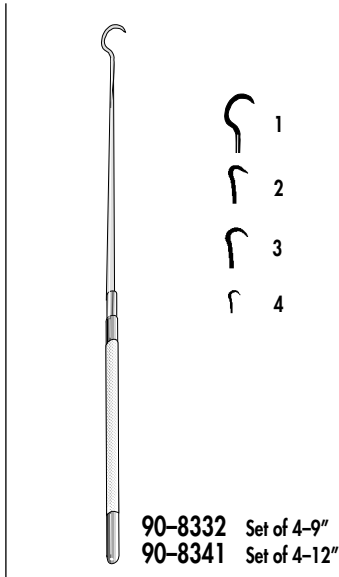
Extra Delicate

- 47-2555 5" Sharp
- 47-2556 5" Blunt



EMMETT HOOK 9"

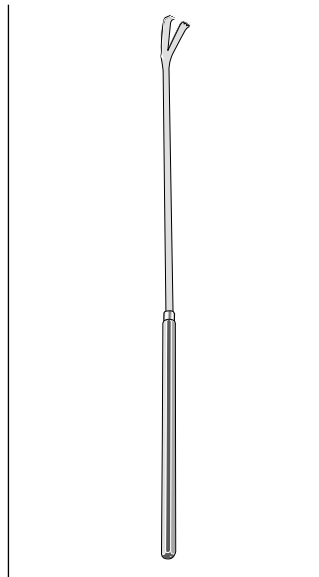
- 90-8301 Style 1
- 90-8302 Style 2
- 90-8303 Style 3
- 90-8304 Style 4
- 90-8305 Style 5



90-8332 Set of 4-9"
90-8341 Set of 4-12"

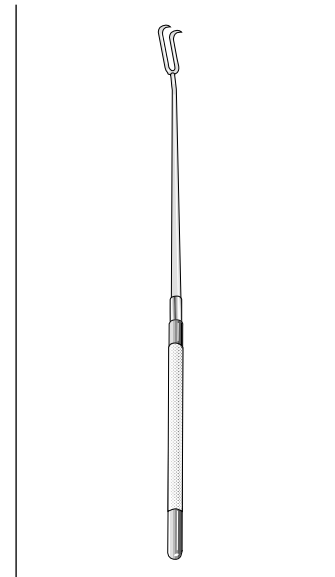
SKLAR RELEASE PATTERN TISSUE HOOKS

- | | | | |
|---------|-----|---------|---------|
| 90-8333 | 9" | 6mm Tip | Style 1 |
| 90-8342 | 12" | 6mm Tip | Style 1 |
| 90-8334 | 9" | 4mm Tip | Style 2 |
| 90-8344 | 12" | 4mm Tip | Style 2 |
| 90-8335 | 9" | 3mm Tip | Style 3 |
| 90-8346 | 12" | 3mm Tip | Style 3 |
| 90-8336 | 9" | 1mm Tip | Style 4 |
| 90-8348 | 12" | 1mm Tip | Style 4 |



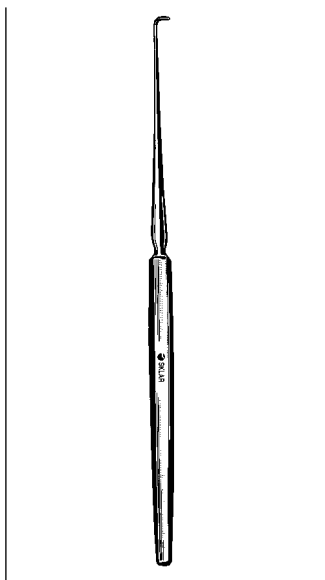
SKLAR CERVICAL MANIPULATOR

90-8355 With micro serrations to prevent slippage



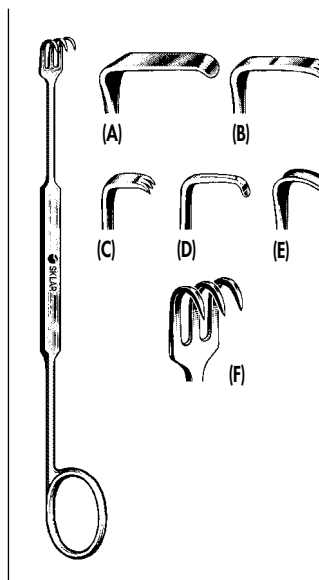
SKLAR CERVICAL HOOK

90-8360 Double sharp hooks offset 20 degrees



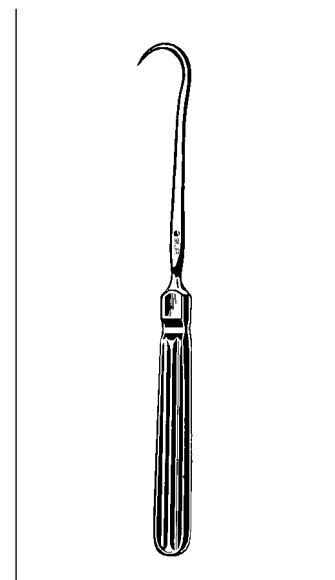
ADSON HOOK

- | | | |
|---------|----|------------------|
| 50-1585 | 8" | Dura Hook, blunt |
| | | Stainless steel |
| 50-1685 | 8" | Sharp |



MEYERDING RETRACTOR

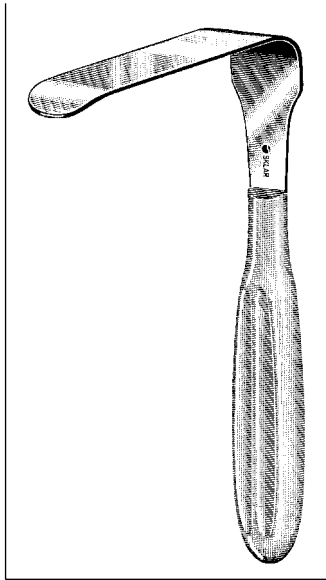
- 7" (17.8 cm)
- | | | |
|---------|---|----------------|
| 22-8210 | A | 1/8" deep |
| 22-8211 | B | 3/8" deep |
| 22-8212 | C | 1/4" deep |
| 22-8213 | D | 3/8" deep |
| 22-8214 | E | 1/4" deep |
| 22-8215 | F | 3 prongs sharp |



SKLAR HOOK

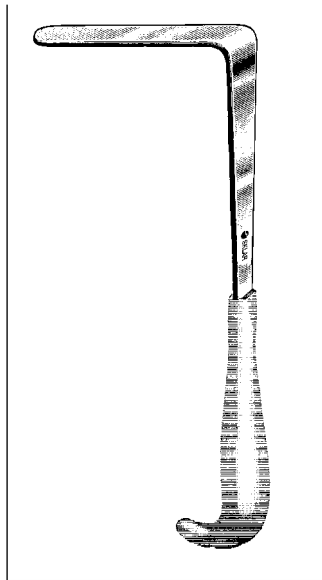
60-6280 8" Single Prong Heavy 1" Tip

RETRACTORS



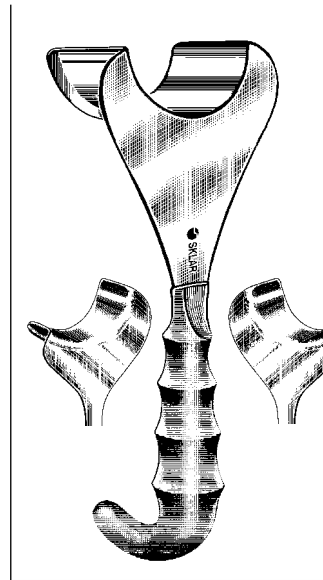
**BRANTLEY-TURNER
RETRACTOR**

90-3470 4" x 1½" 7"



**PRYOR-PEAN
RETRACTOR**

90-3510 4¼" x 1" 10¾"



DELEE RETRACTOR

Right

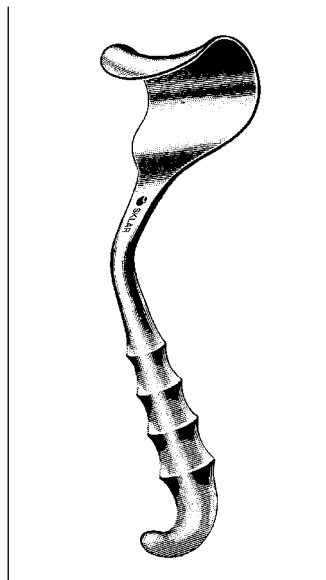
90-3450 2¾" x 2"

Left

90-3451 2¾" x 2"

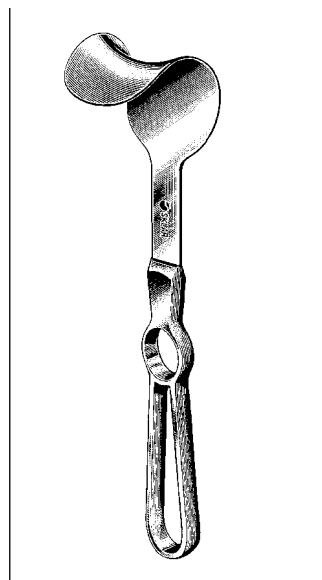
Universal

90-3452 2¾" x 2"



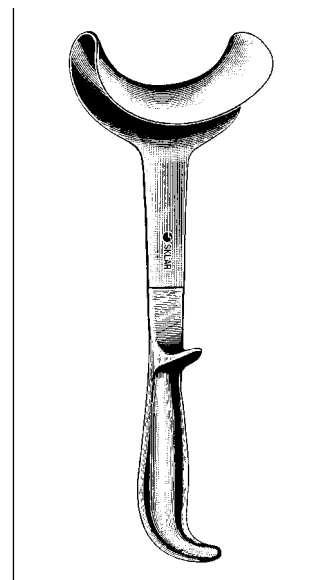
**MAYO ABDOMINAL
RETRACTOR**

60-2110 2¾" x 10"



FRITCH RETRACTOR

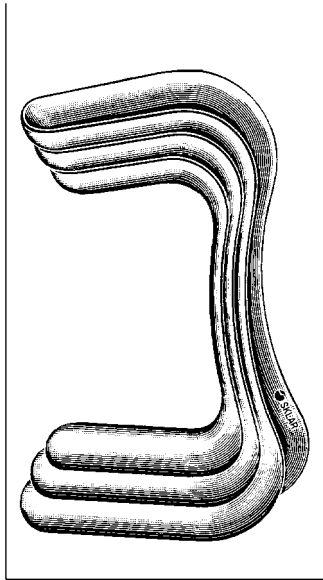
60-2010 2¾" x 2" 9¼"



**DOYEN ABDOMINAL
RETRACTOR**

Straight

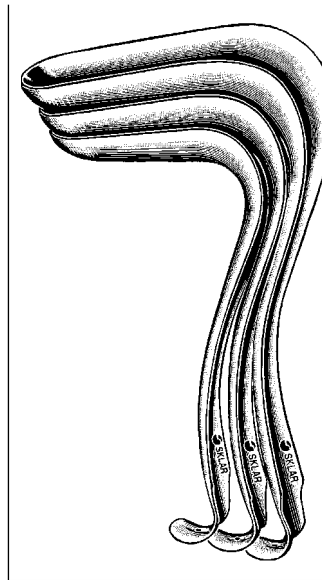
60-1797 3½" x 2" 9¼"



SIMS RETRACTOR

Double end

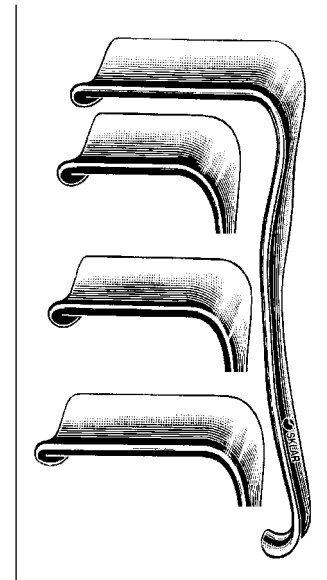
90-3150	7/8" x 2 1/2"	1 x 3	#1
90-3151	1" x 2 1/2"	1 1/8" x 3	#2
90-3152	1" x 3"	1 1/4" x 3 1/4"	#3
90-3153	1 1/4" x 3"	1 1/2" x 3 1/4"	#4
90-3154	1 1/4" x 3 1/4"	1 1/2" x 4"	#5
90-3155	1 1/4" x 3 1/4"	1 3/4" x 4"	#6



SIMS RETRACTOR

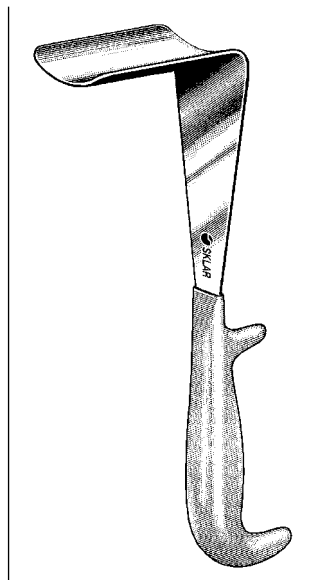
Single end

90-3225	2 1/2" x 1"
90-3230	3" x 1 1/4"
90-3235	3 1/2" x 1 1/2"



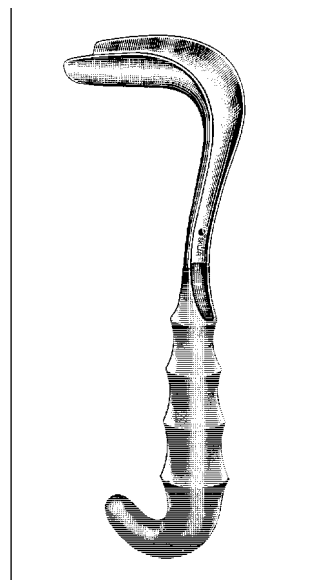
EASTMAN RETRACTOR

90-3030	Small	3 x 1 1/2"
90-3035	Medium	3 1/2" x 1 1/2"
90-3040	Large	4 x 1 1/2"



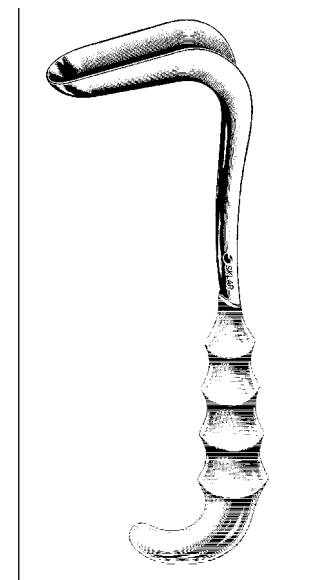
DOYEN RETRACTOR

60-2185	1 3/4" x 2 1/2"	8 1/2"
60-2190	2 1/8" x 3"	8 1/2"
60-2195	2 1/4" x 3 1/2"	8 1/2"



SIMS-KELLY RETRACTOR

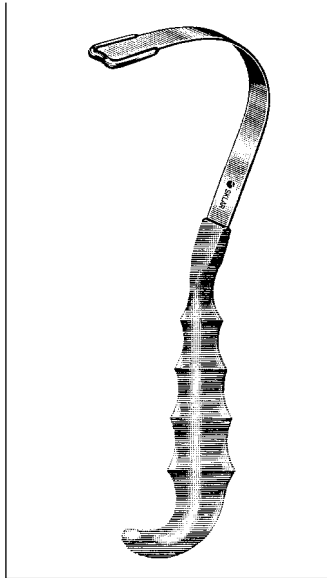
90-3422	2 1/4" x 1"
90-3427	2 3/4" x 1 1/4"
90-3430	3" x 1 1/2"



SIMS RETRACTOR SKLAR-GRIP HANDLE

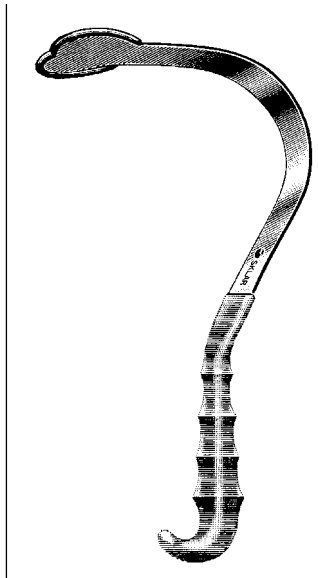
90-3327	2 3/4" x 1"
90-3330	3" x 1 1/4"
90-3335	3 1/2" x 1 1/2"

RETRACTORS



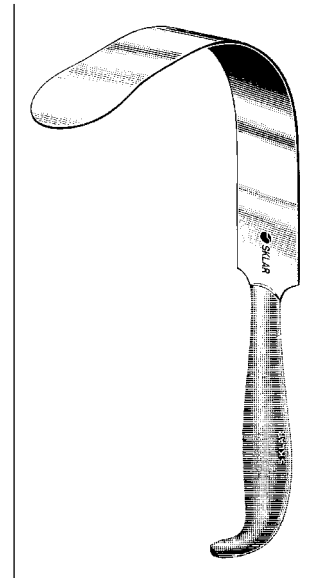
HARRINGTON RETRACTOR

22-7795 $\frac{3}{4}$ " x $9\frac{1}{2}$ " Pediatric



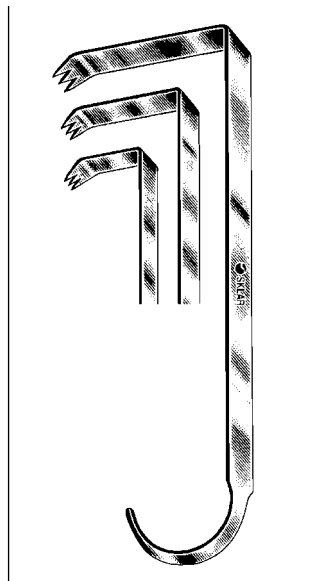
HARRINGTON THORACIC RETRACTOR

12 $\frac{1}{2}$ " Long
55-7115 $1\frac{1}{2}$ " x 5" Blade Depth
55-7125 $2\frac{1}{2}$ " x 5" Blade Depth



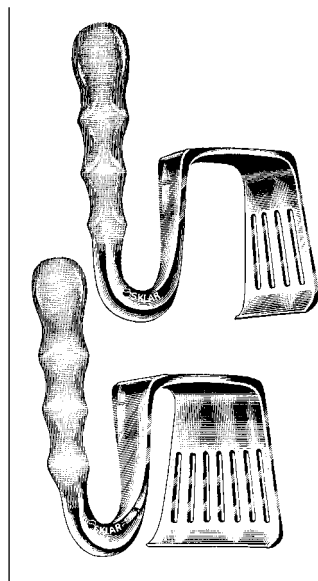
FOSS BILIARY DUCT RETRACTOR

60-2395 $1\frac{3}{4}$ " x $9\frac{1}{2}$ "



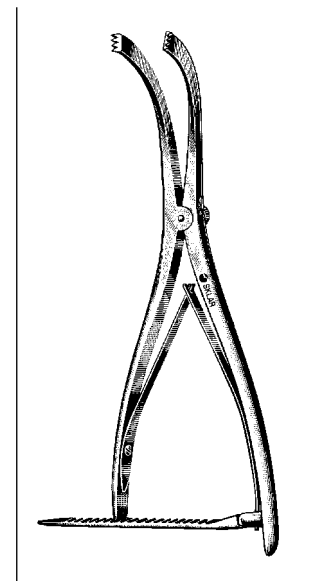
HIBBS RETRACTOR

55-7167 $\frac{1}{2}$ " x $1\frac{1}{4}$ " $6\frac{3}{4}$ "
55-7175 $\frac{5}{8}$ " x 2" 9"
55-7192 1" x 3" $9\frac{1}{2}$ "



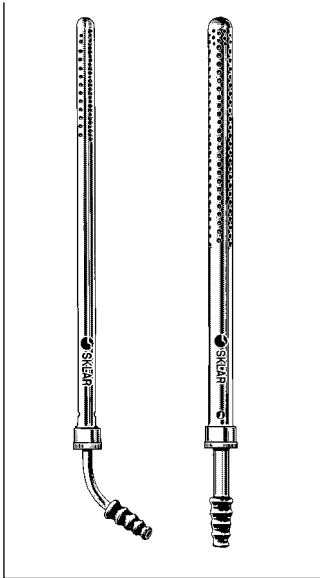
DAVIDSON SCAPULA RETRACTOR

55-7195 Large 3 " x $3\frac{1}{2}$ "
55-7196 Small 3 " x 2"



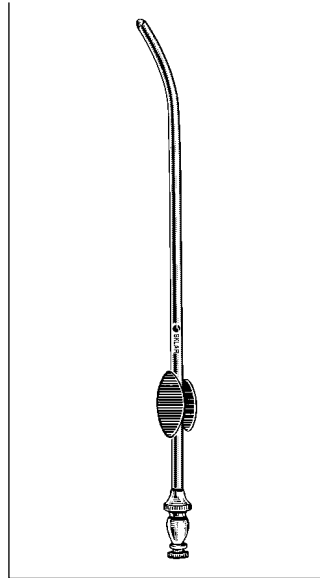
INGE RETRACTOR

42-1420 $6\frac{1}{2}$ "
42-1425 $10\frac{1}{2}$ "



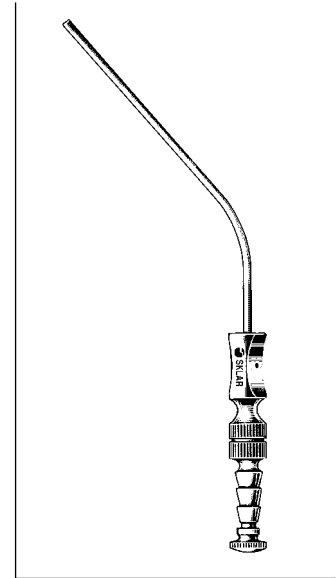
POOLE SUCTION TUBE

Slip on end
 22-6577 16 French Curved Pediatric
 34-2023 23 French Curved
 34-2230 30 French Straight



ADSON SUCTION TUBE

50-1982 6" 12 French



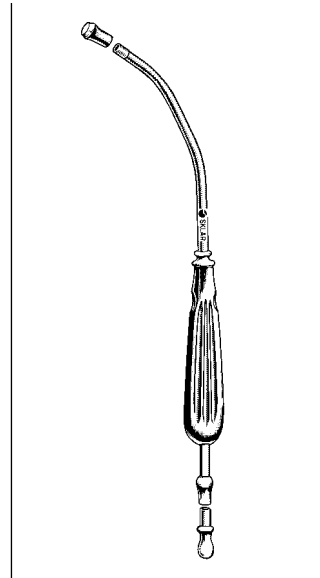
FRAZIER SUCTION TUBE

50-2006 6 French
 50-2007 7 French
 50-2008 8 French
 50-2010 10 French
 50-2012 12 French



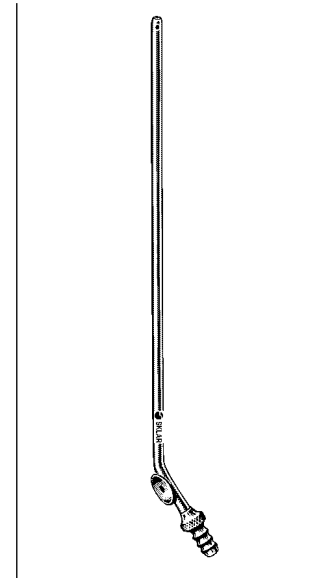
BARON SUCTION TUBE

50-1953 3 French
 50-1955 5 French
 50-1957 7 French



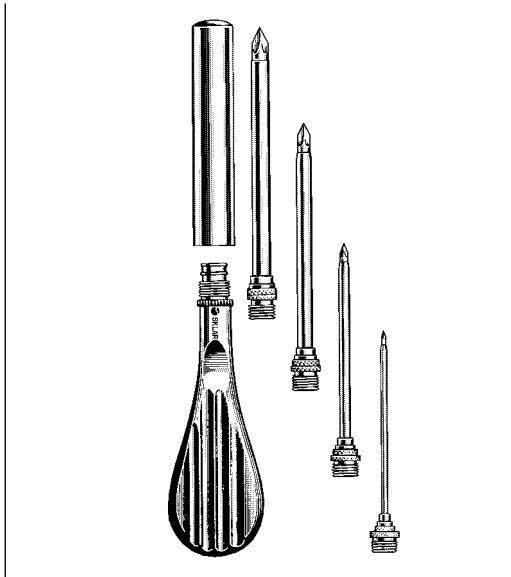
YANKAUER SUCTION TUBE

Chrome Plated
 07-1801 Standard size
 07-1802 Tip for 1801
 22-6585 Pediatric size
 22-6586 Tip for 6585
 07-1805 Stainless Steel - Standard size
 07-1806 Tip Only For 07-1805



BUIE SUCTION TUBE

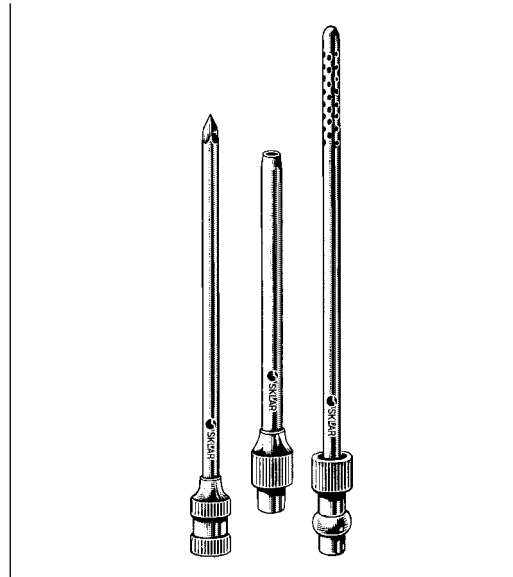
80-2715 15 French with Valve
 80-2815 15 French without Valve



TROCAR SET OF FOUR

Nested in Flat Handle

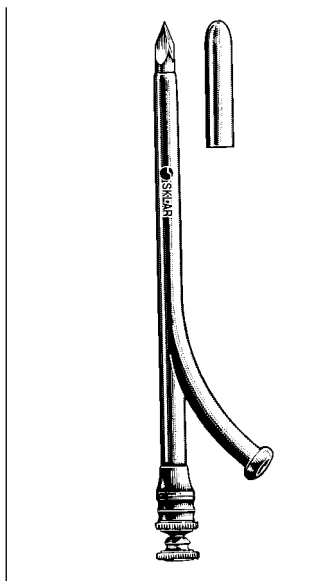
34-1014 5½" 6,9,13,17 French



DUKE IMPROVED TROCAR

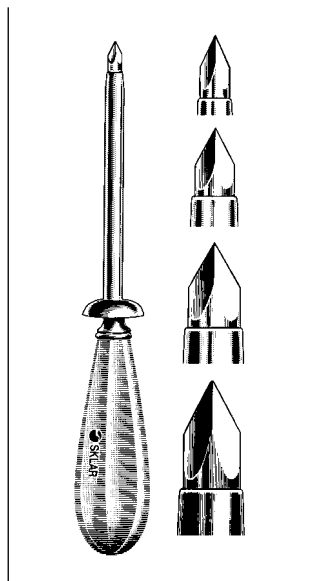
Perforated Cannula

34-1017 4¼" 17 French



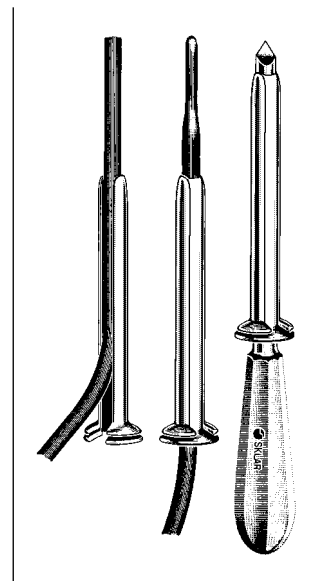
OCHSNER TROCAR

34-1410	10 French	6 Fr Cath
34-1414	14 French	10 Fr Cath
34-1417	17 French	12 Fr Cath
34-1420	20 French	16 Fr Cath
34-1424	24 French	20 Fr Cath
34-1428	28 French	22 Fr Cath



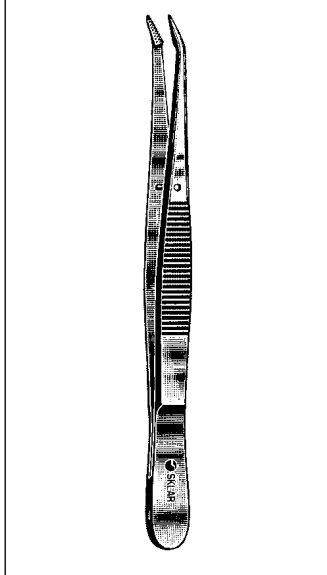
NELSON TROCAR

34-2422	#1	8¼"	25 French
34-2428	#2	8¼"	30 French
34-2434	#3	8¼"	33 French
34-2438	#4	8¼"	35 French

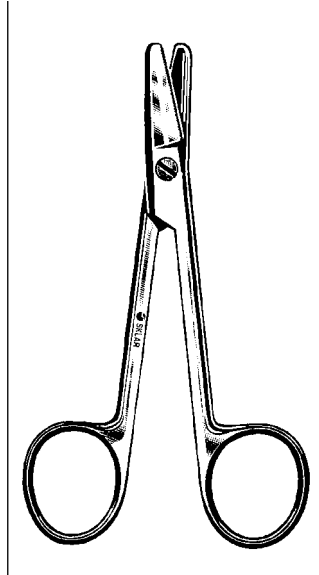


HURWITZ TROCAR

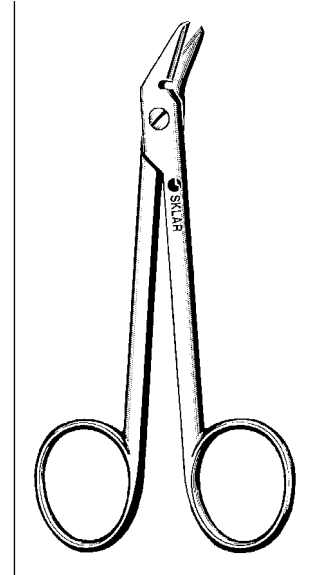
22-7822	22 French
34-2526	26 French
34-2536	36 French



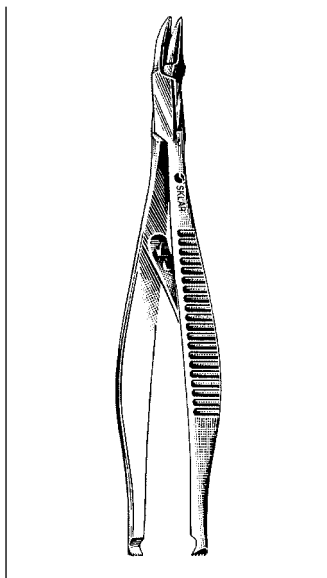
HEALY SUTURE FORCEPS
24-2155 5½"



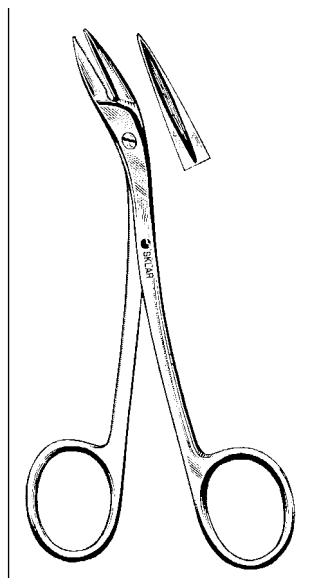
SUTURE WIRE CUTTING SCISSORS
24-2347 4¾" Straight,
Serrated Edges



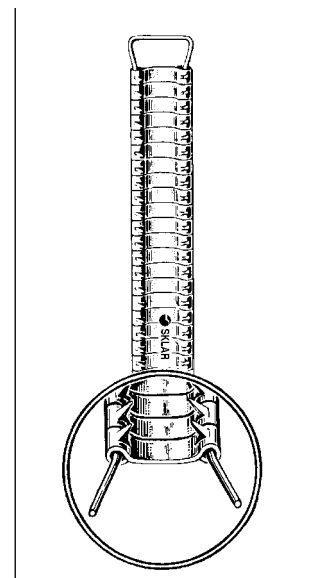
SUTURE WIRE CUTTING SCISSORS
Angular Serrated
24-2342 4¾"
Tungsten Carbide
Angular Serrated
16-2800 4¾"



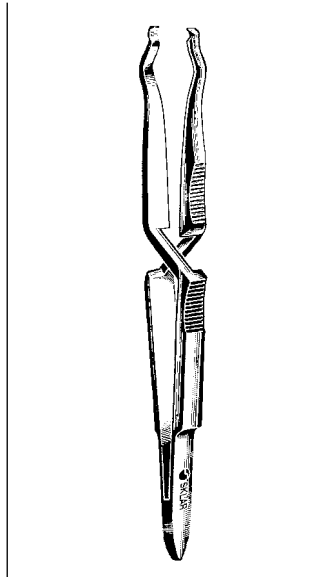
MICHEL APPLYING AND REMOVING FORCEPS
24-1250 5"



MICHEL CLIP REMOVING FORCEPS
24-2055 5½"

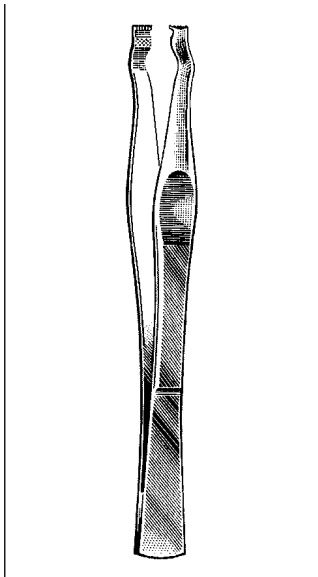


MICHEL TRU-CLIPS
24-1014 14 mm
24-1016 16 mm
24-1018 18 mm



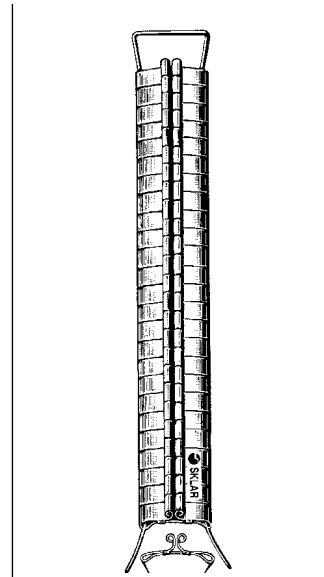
**WACHENFELDT CLIP
FORCEPS**

X-Action
24-1450 5"



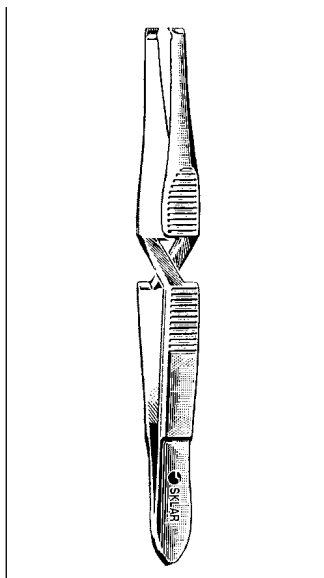
**WACHENFELDT CLIP
FORCEPS**

24-1350 5"



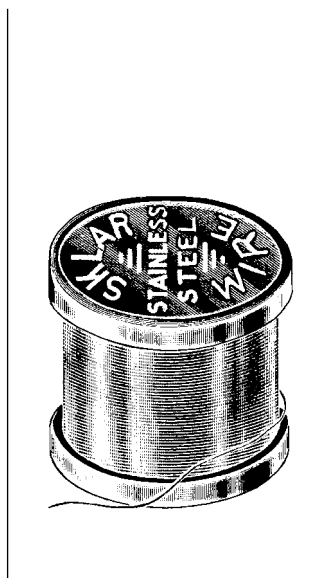
**WACHENFELDT WOUND
CLIPS**

24-1112 12 mm
24-1114 14 mm
24-1116 16 mm
24-1118 18 mm
24-1120 20 mm



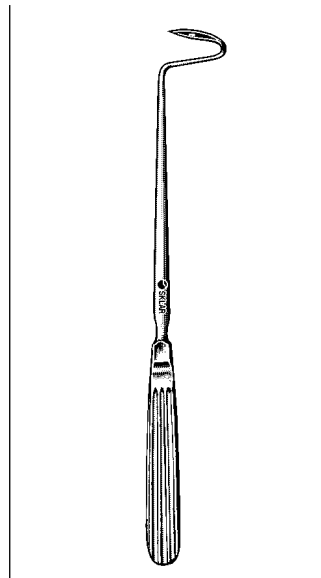
**HEGENBARTH CLIP
APPLYING FORCEPS**

Straight
24-1650 5"



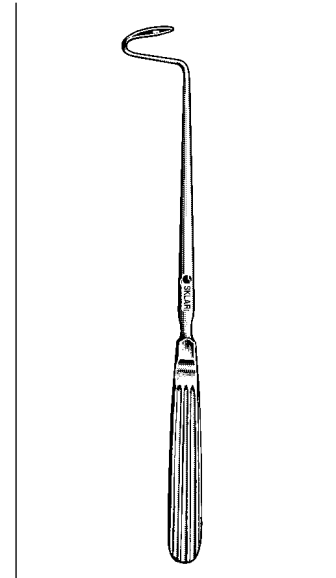
**STAINLESS SUTURE
WIRE**

24-2220	¼ lb	20 guage
24-2222	¼ lb	22 guage
24-2224	¼ lb	24 guage
24-2226	1 oz	26 guage
24-2228	1 oz	28 guage
24-2230	1 oz	30 guage
24-2232	1 oz	32 guage



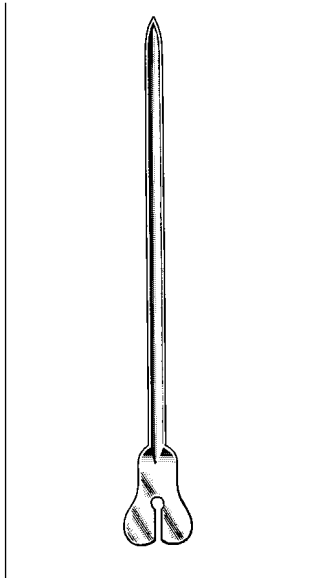
DESCHAMP NEEDLE

Sharp
26-1480 8" Curved Right
26-1580 8" Curved Left



DESCHAMP NEEDLE

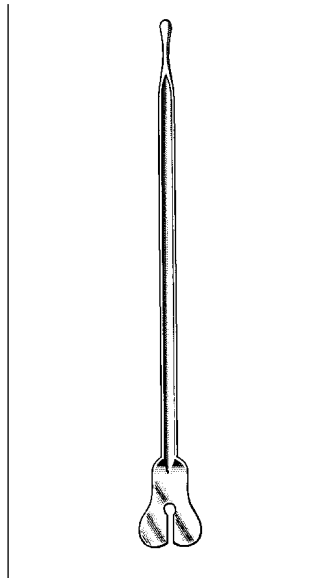
Blunt
26-1280 8" Curved Right
26-1380 8" Curved Left



DIRECTOR AND TONGUE TIE

Plain End

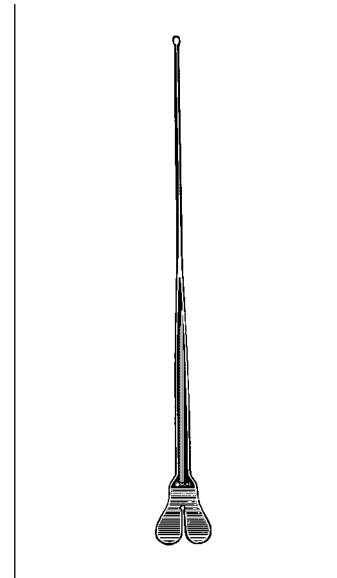
30-1045	4½"
30-1050	5"
30-1055	5½"
30-1060	6"
30-1070	7"
30-1080	8"



DIRECTOR AND TONGUE TIE

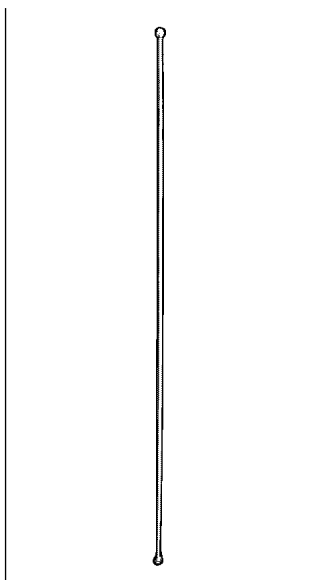
Probe End

30-1145	4½"
30-1150	5"
30-1155	5½"
30-1160	6"
30-1170	7"
30-1180	8"



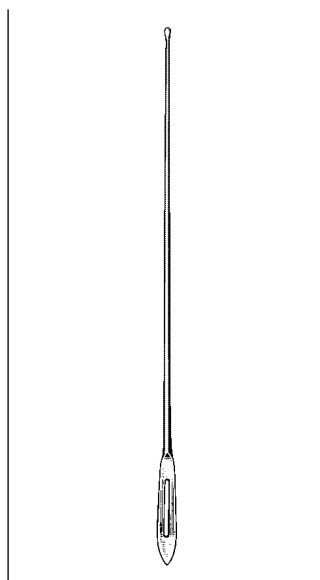
LARRY PROBE

80-2870 7½" (18.1 cm)



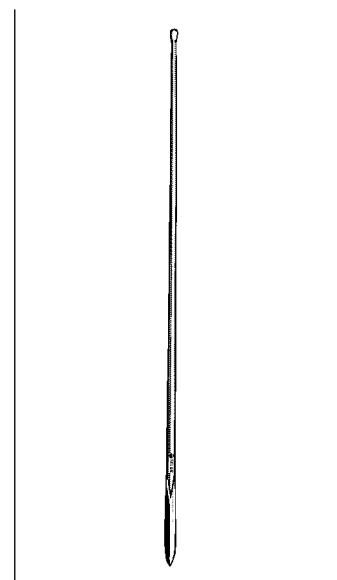
DOUBLE ENDED PROBE

30-1545	4½"
30-1550	5"
30-1555	5½"
30-1560	6"
30-1580	8"
30-1610	10"
30-1612	12"



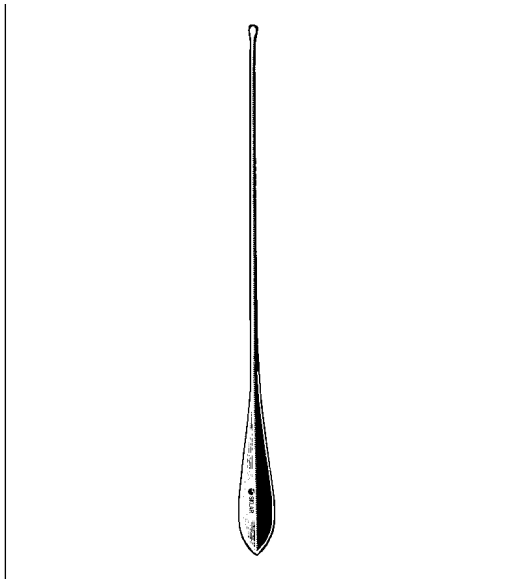
PROBE WITH EYE

30-1945	4½"
30-1950	5"
30-1955	5½"
30-1960	6"
30-1980	8"
30-2010	10"
30-2012	12"



SPEAR POINT PROBE

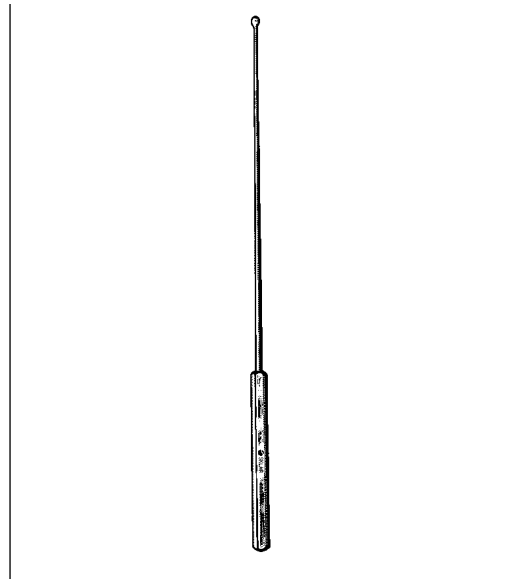
30-2145	4½"
30-2150	5"
30-2155	5½"
30-2160	6"
30-2212	12"



PROBE

With Myrtle Leaf End

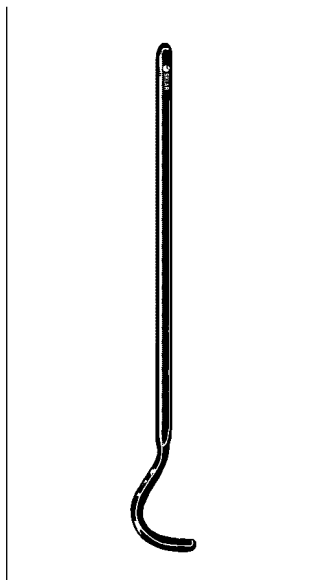
30-1450 5" (12.7 cm) Straight



BARR FISTULA PROBE

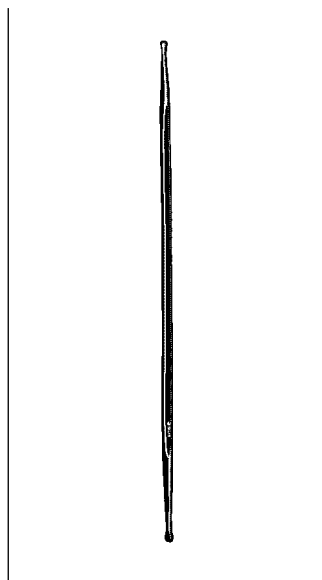
With Eye

80-2910 10 3/4" (27.3 cm)



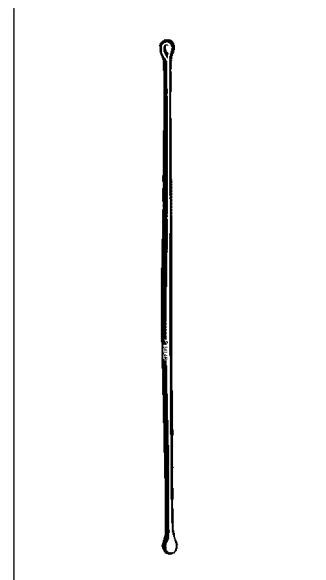
COOPER DIRECTOR AND ANEURISM NEEDLE

30-1350 5" (12.7 cm)



ESMARCH TIN BULLET PROBE

30-1380 8" (20.3 cm)



RECTAL AND BULLET PROBE

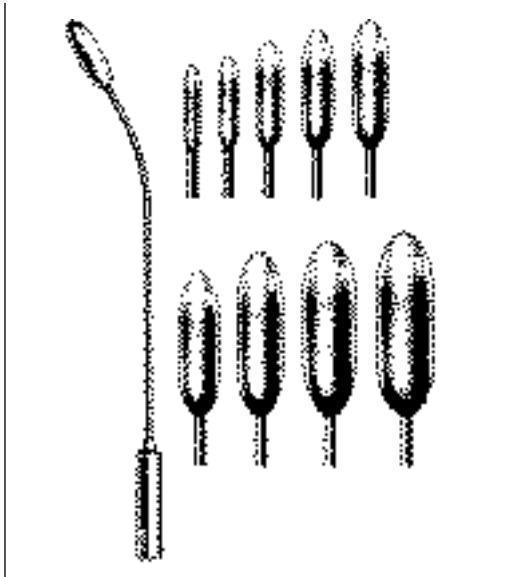
Double Ended

30-2580 8" (20.3 cm) Rectal Probe

Copper not plated

30-2680 8" (20.3 cm) Bullet Probe

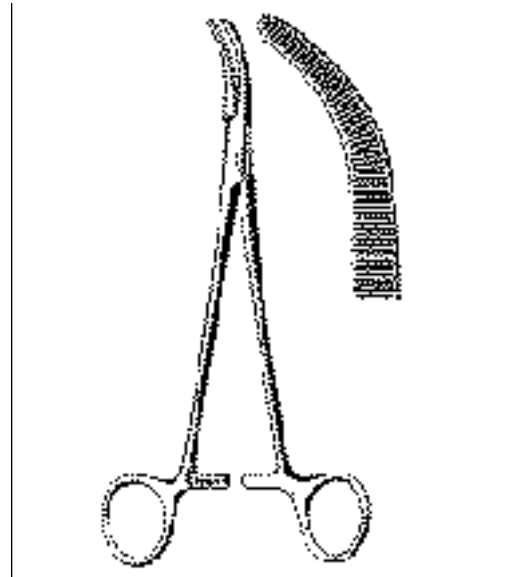
Aluminum



BAKES DILATOR

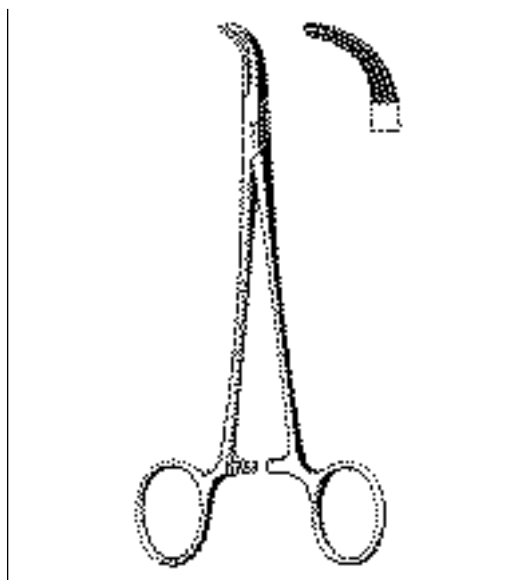
Malleable Shaft 10" to 10 3/4"

32-1533	3 mm	32-1538	8 mm
32-1534	4 mm	32-1539	9 mm
32-1535	5 mm	32-1610	10 mm
32-1536	6 mm	32-1611	11 mm
32-1537	7 mm	32-1530	Set of 9 in Khaki case



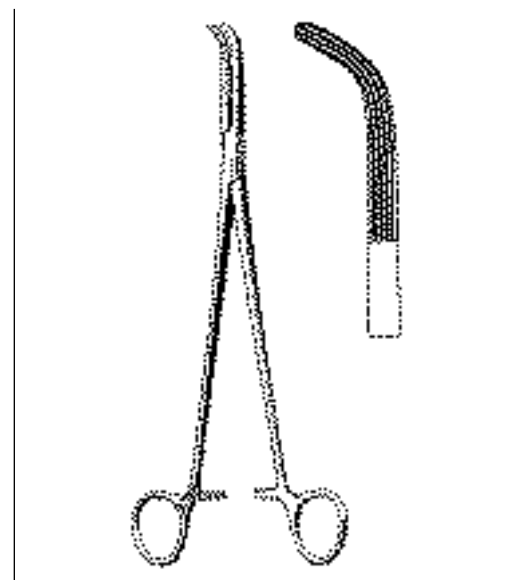
MOYNIHAN GALL DUCT FORCEPS

32-1785 8 1/2"



LOWER GALL DUCT FORCEPS

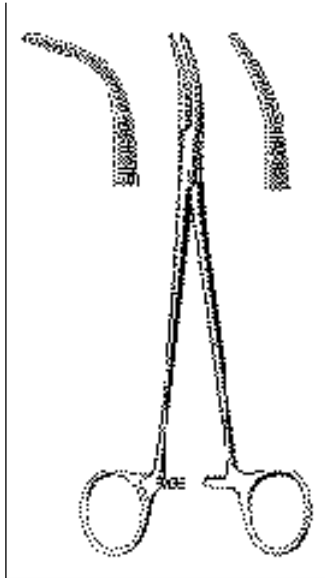
32-1870 7"



LAHEY GALL DUCT FORCEPS

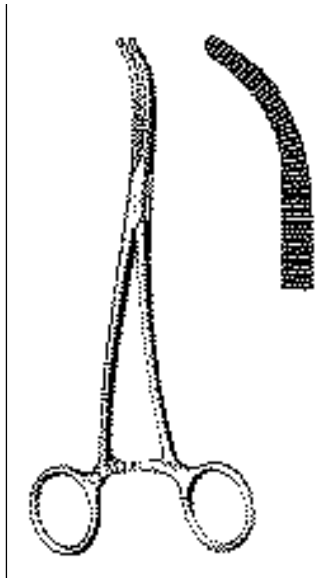
32-1875 7 1/2"
 32-1890 9"
 32-1990 9" Heavy

GALL BLADDER INSTRUMENTS



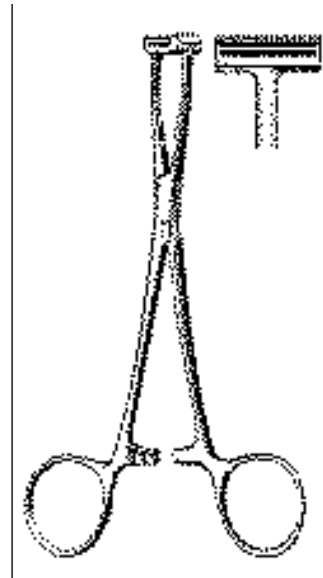
VARCO GALL BLADDER FORCEPS

32-2075 7½" Shallow Curve
32-2175 7½" Full Curve



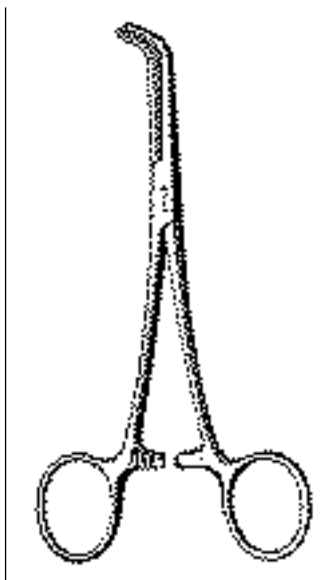
SHALLCROSS FORCEPS

Double Curve
32-2070 7"



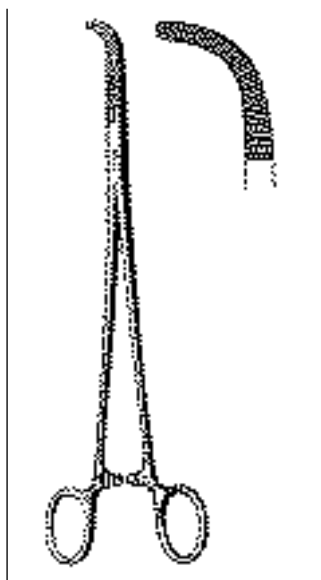
PRATT T-SHAPE CLAMP

17-1055 6"



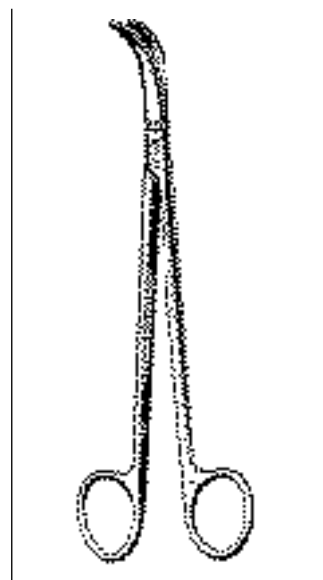
MIXER GALL DUCT FORCEPS

17-1772 7¼"



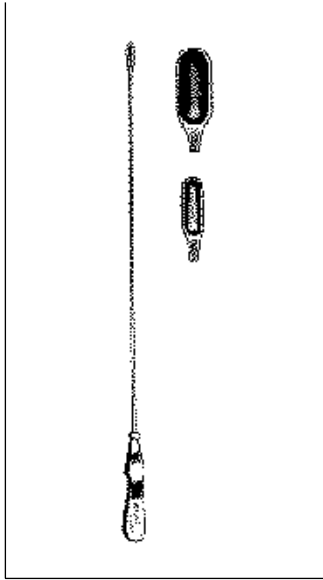
MIXER FORCEPS

22-3255 5½"
22-3270 7" Delicate
55-2890 9" Delicate Gemini
55-2912 12" Delicate



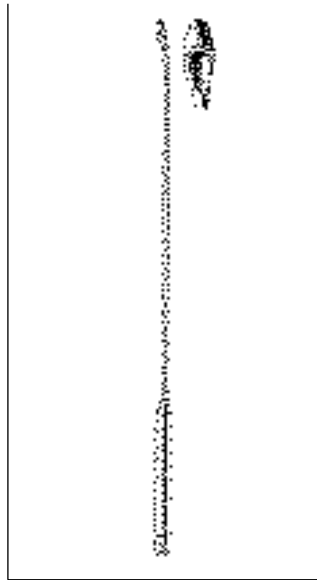
THOREK SCISSORS

Full Curve
15-3172 7¼"



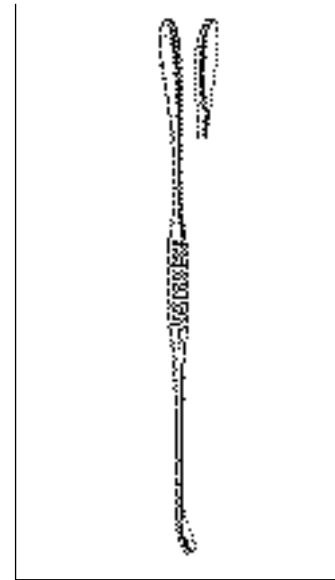
MAYO COMMON DUCT SPOON

32-1014 10½" (26.7 cm) Small
Silver plated
32-1016 Large
Silver plated



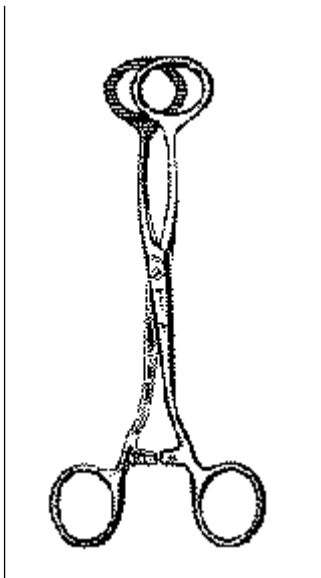
DESJARDIN GALLSTONE SCOOP

32-1124 Malleable 11"



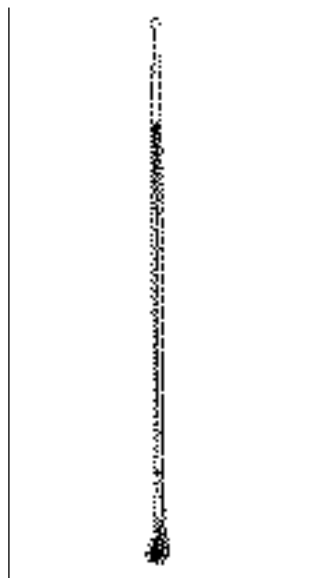
MAYO GALLSTONE SCOOP

Double End
32-1040 10½"



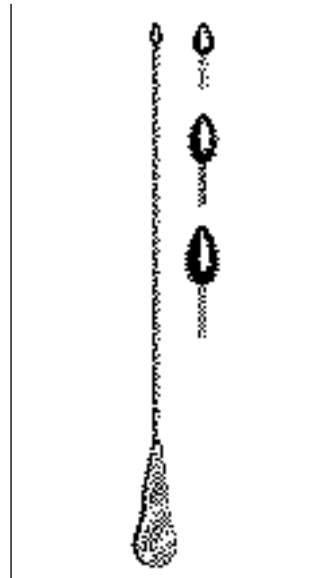
JUDD-DE MARTEL GALL BLADDER FORCEPS

32-2465 6½" (16.5 cm)



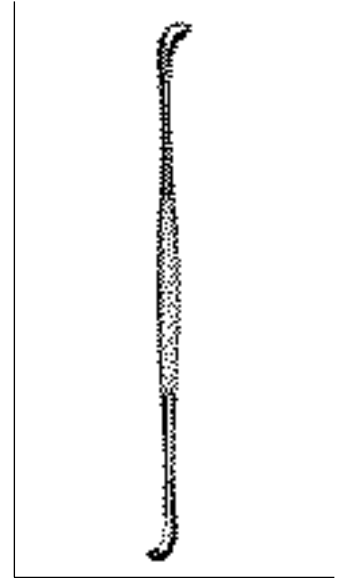
MOYNIHAN PROBE AND SCOOP

Pure Tin
32-1140 13½"



MAYO COMMON DUCT PROBE

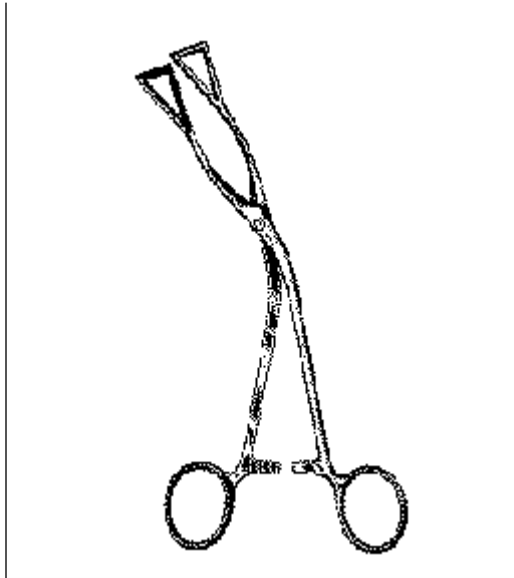
Silver Plated 10"
32-1215 15 French
32-1218 18 French
32-1220 20 French



FERGUSON SCOOP

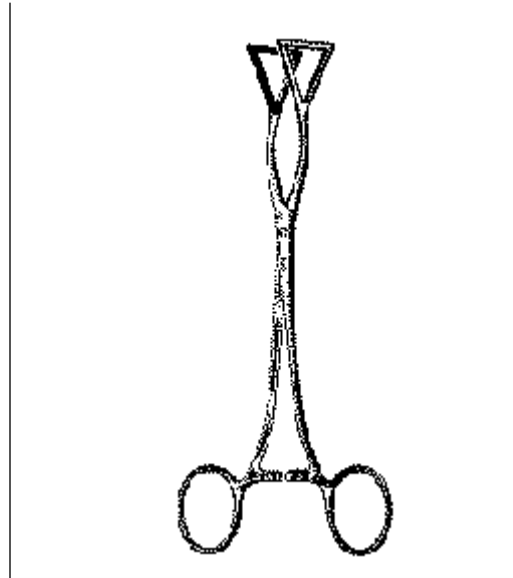
Double End
32-1037 9½"

GALL BLADDER INSTRUMENTS



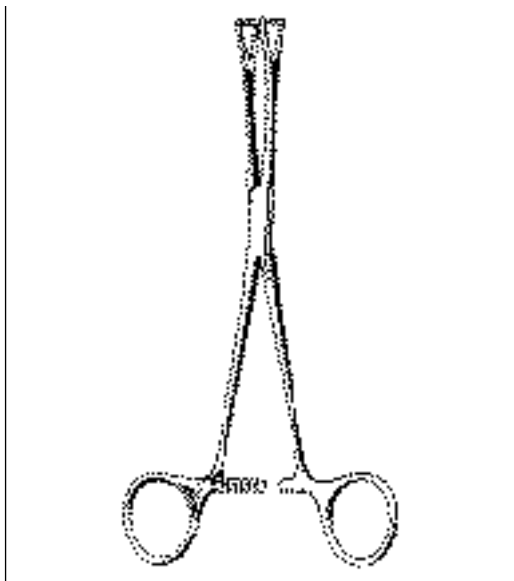
LOVELACE GALL BLADDER TRACTION FORCEPS

Angular
32-2470 7" (17.8 cm)



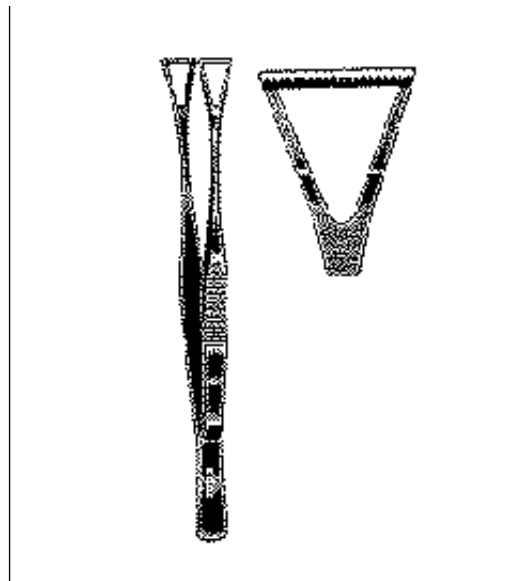
LOVELACE GALL BLADDER TRACTION FORCEPS

Straight
32-2477 7½" (19.7 cm)



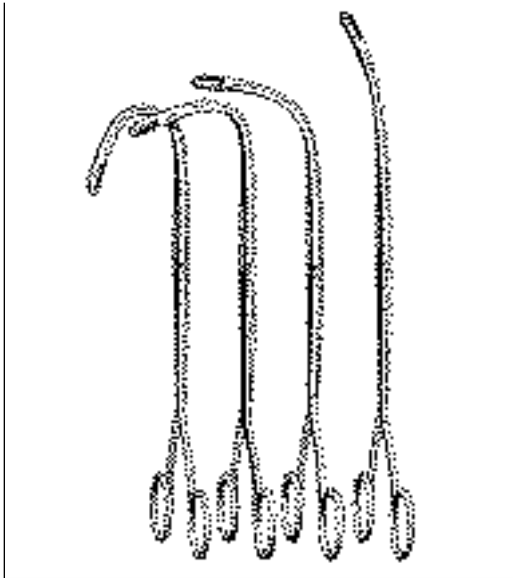
DUVAL LUNG GRASPING FORCEPS

36-2577 1" (2.5 cm) jaw
Length 8" (19.7 cm)
36-2595 1" (2.5 cm) jaw
Length 9½" (24.1 cm)



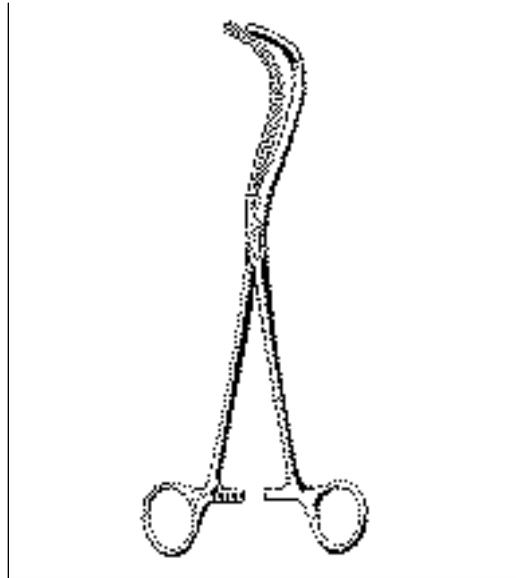
COLLINS-DUVAL LUNG GRASPING FORCEPS

36-2607 1" (2.5 cm) jaw wide
Length 8½" (21.6 cm)



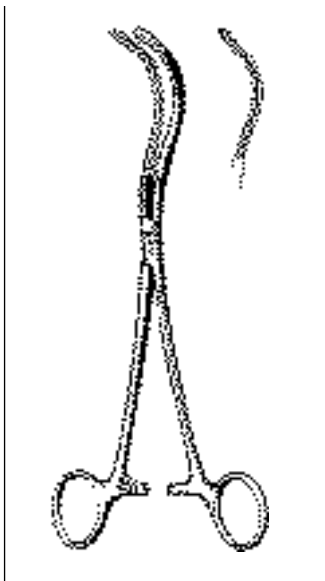
RANDALL KIDNEY STONE FORCEPS

33-1001	9 1/2"	1/4 Curve
33-1002	8 1/2"	1/4 Curve
33-1003	7 1/2"	1/4 Curve
33-1004	7 1/2"	Full Curve



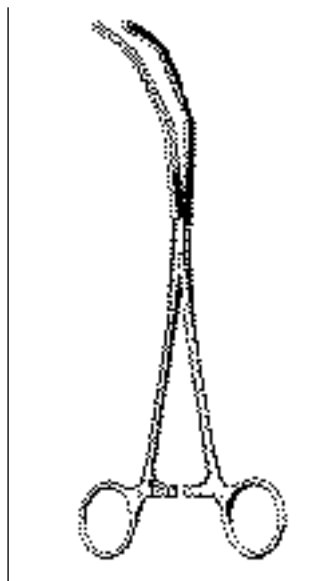
MAYO-GUYON KIDNEY CLAMP

33-1090 9"



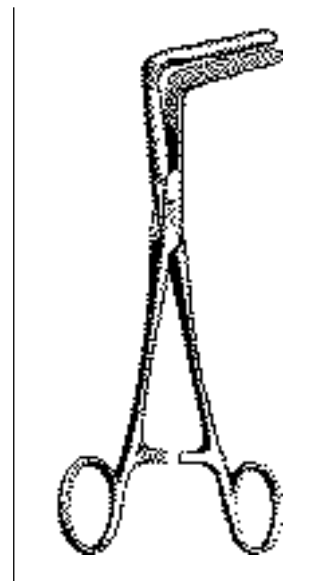
STILLE KIDNEY CLAMP

33-1190	9"	Light
33-1210	10"	Heavy



HERRICK KIDNEY CLAMP

33-1290	9"	Light
33-1297	9 1/4"	Heavy

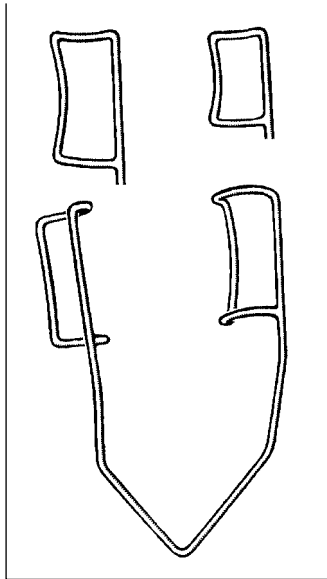


WERTHEIM-CULLEN PEDICLE CLAMP

33-1375 8 1/2" 2 1/2" jaws

EYE INSTRUMENTS

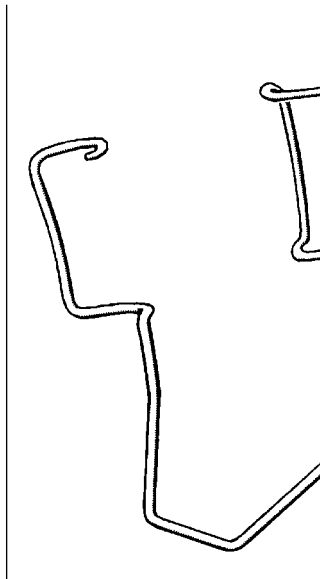
SPECULA



BARRAQUER WIRE SPECULUM

1½" long

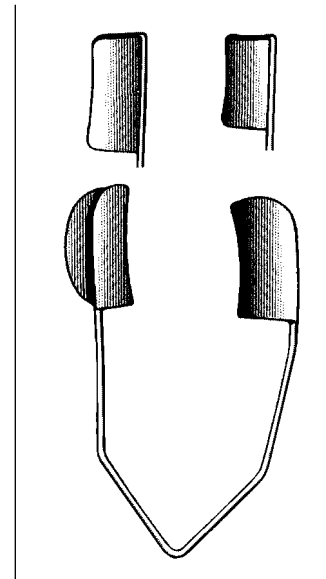
- 65-1740 10 mm loop, child
- 65-1742 15 mm loop, adult
- 65-1744 15 mm loop, adult, heavy wire
- 65-1746 8 mm loop, infant
- 65-1748 4 mm loop, infant, delicate



KRATZ-BARRAQUER WIRE EYE SPECULUM

Blade width 14 mm

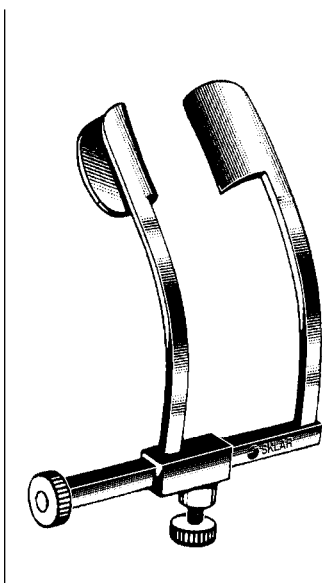
- 65-1750 18 mm blade spread adult
- 65-1752 15 mm blade spread child
- 65-1754 12 mm blade spread infant



BARRAQUER WIRE SPECULUM

1½" long

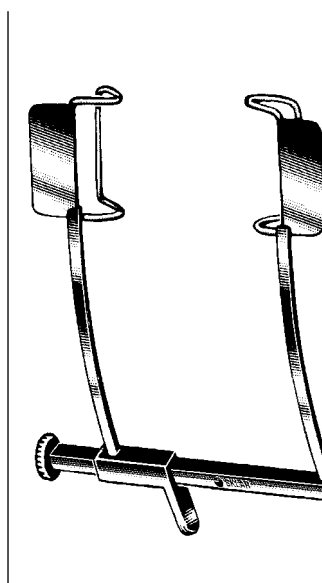
- 65-1756 10 mm solid blade child
- 65-1758 15 mm solid blade adult



COOK EYE SPECULUM

2" Long

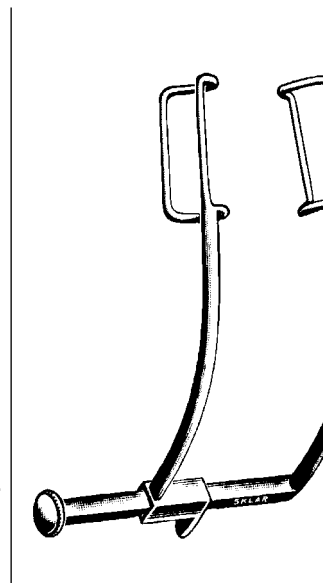
- 65-1765 9 x 3 mm solid blade spread 25 mm, infant
- 65-1766 11 x 3 mm solid blade spread 27 mm, adult



WIENER EYE SPECULUM

2¼"

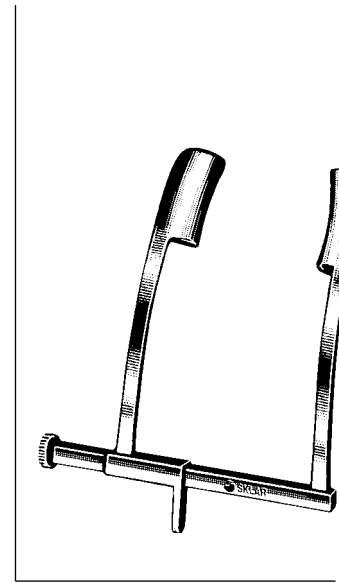
- 65-1790 15 mm blades with extensions to cover eye lashes, chrome



MURDOCK EYE SPECULUM

2"

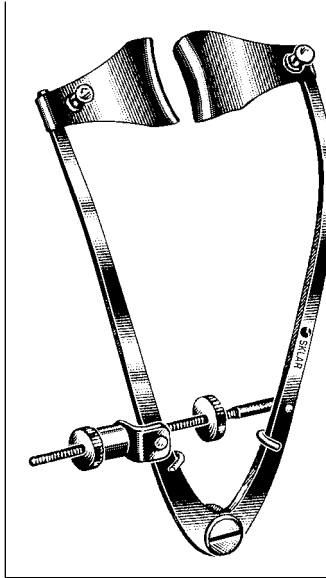
- 65-1022 23 mm spread 14 mm blade



McKINNEY EYE SPECULUM

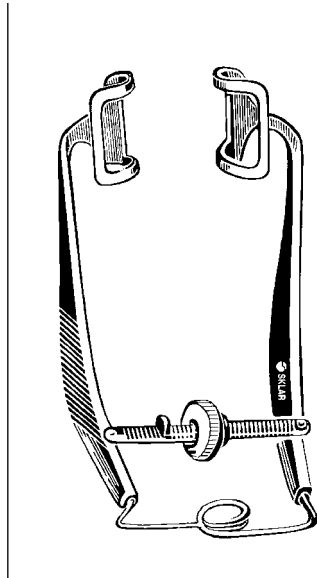
2½"

- 65-1795 15 mm blades wide, chrome



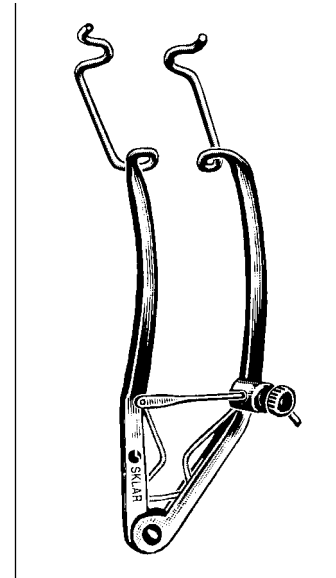
**McPHERSON EYE
SPECULUM**

65-7360 3¼" Blades 13 mm wide
with suture posts



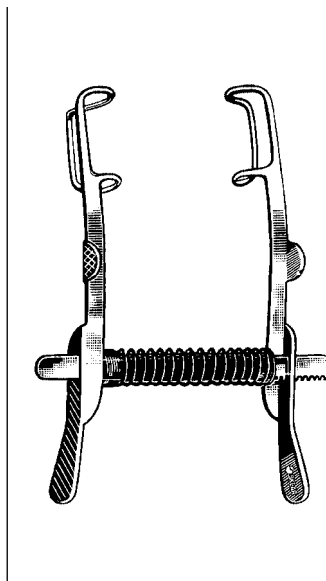
ZIEGLER SPECULUM

65-1522 2¼"



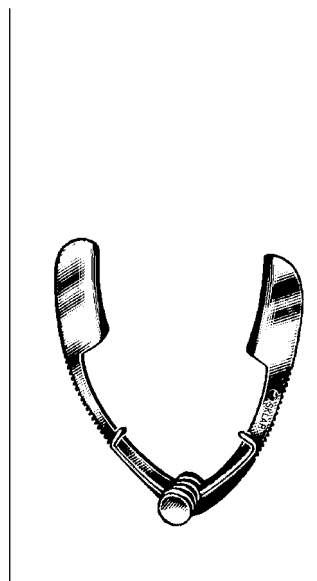
KNAPP EYE SPECULUM

65-1545 Non-magnetic



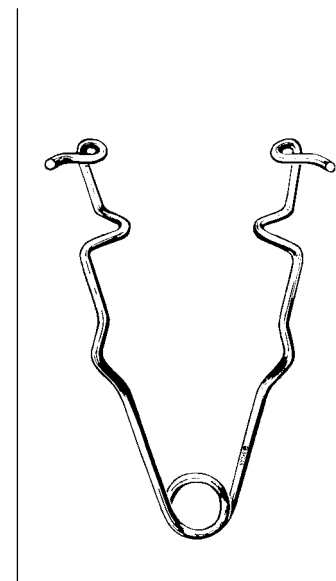
MELLINGER SPECULUM

65-1427 2¾" Adult



SAUER EYE SPECULUM

Infant
65-1012 1¼" 10 mm

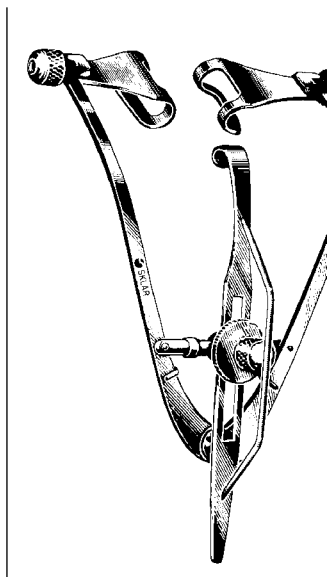


PLAIN WIRE SPECULUM

65-1120 2" Child
65-1127 2¾" Adult

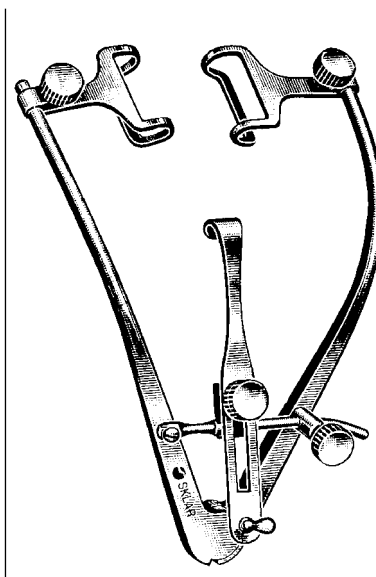
EYE INSTRUMENTS

SPECULA



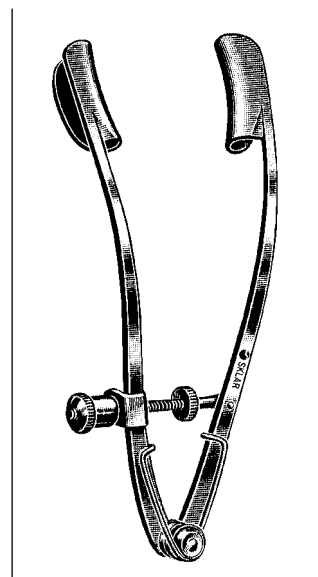
PARK-MAUMENEE EYE SPECULUM

65-1528 Non-magnetic guard over locking screw



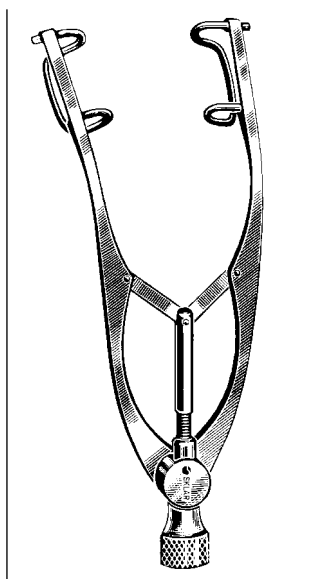
PARK-GUYTON EYE SPECULUM

65-1530 3" length



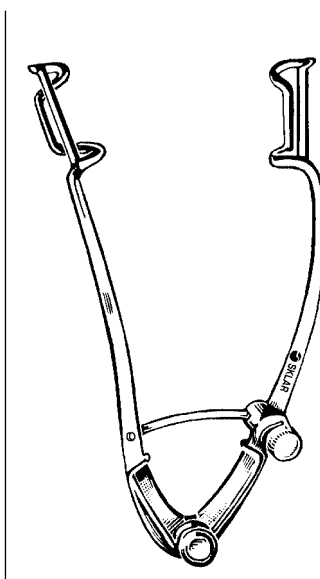
LANCASTER EYE SPECULUM

65-1534 Non-magnetic, malleable shafts that can be bent to any angle
65-1532 Standard Pattern



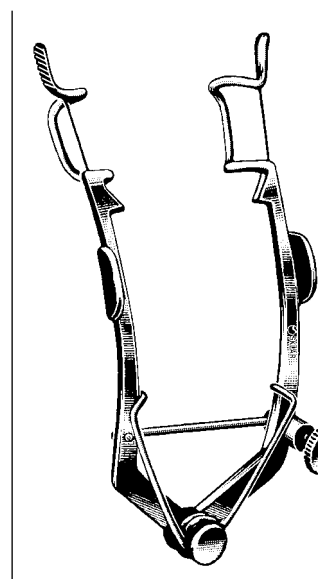
CASTROVIEJO SPECULUM

65-1535 3 1/2"



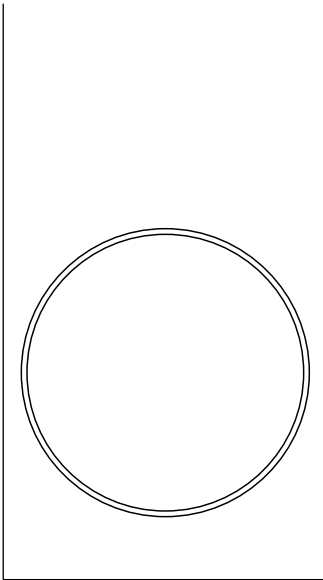
WILLIAMS SPECULUM

65-1227 2 1/4" Child
65-1332 3 1/4" Adult



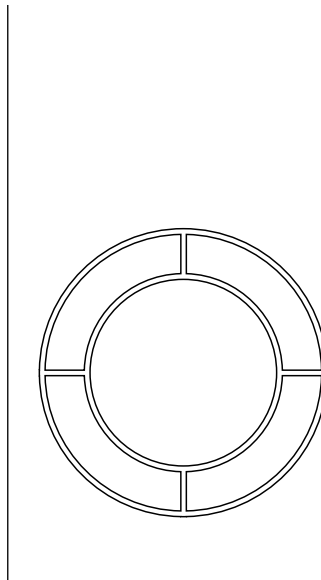
WEEKS EYE SPECULUM

65-1730 3 1/4" long 15 x 5 mm loop



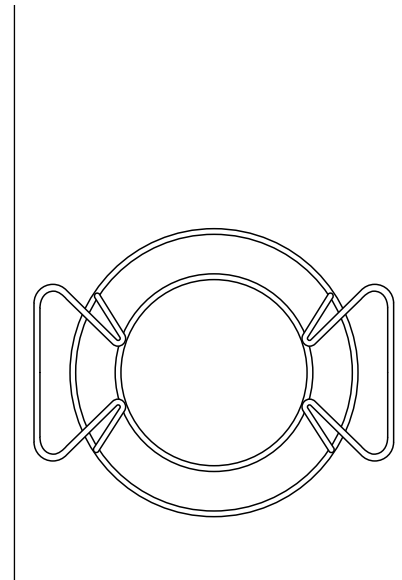
FLIERINGA FIXATION RING

- 66-7814 14 mm Diameter
- 66-7816 16 mm Diameter
- 66-7818 18 mm Diameter
- 66-7820 20 mm Diameter
- 66-7822 22 mm Diameter
- 66-7824 24 mm Diameter



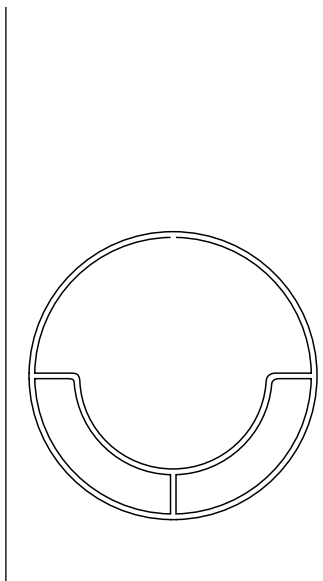
FLIERINGA-LeGRAND FIXATION RING

- 66-7830 14 x 23 mm Diameter



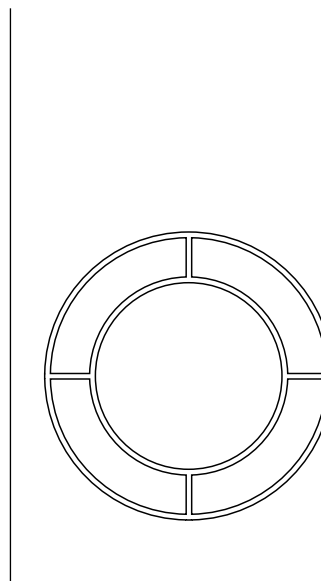
McNEIL-GOLDMAN FIXATION RING

- 66-7835 14 x 23 mm Diameter



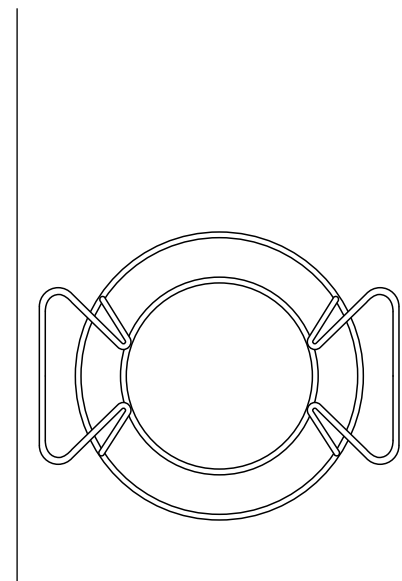
FIXATION RING

- Casanova
- 66-7840 15 x 24 mm Diameter
- Bessieres
- 66-7842 17 x 24 mm Diameter



FLIERINGA-LeGRAND FIXATION RING

- 66-7850 17 x 24 mm Diameter

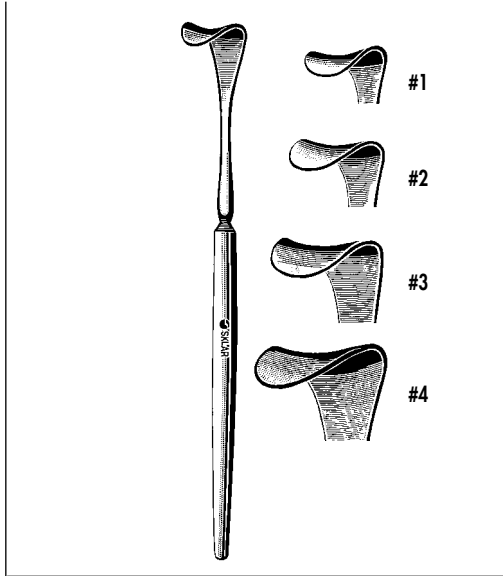


McNEIL-GOLDMAN FIXATION RING

- 66-7852 17 x 24 mm Diameter

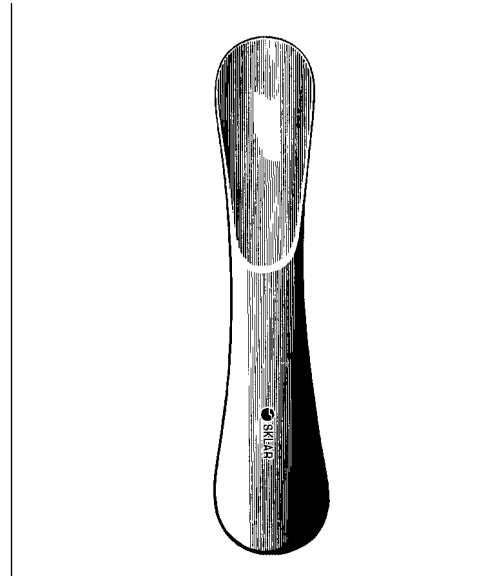
EYE INSTRUMENTS

RETRACTORS/EXPRESSORS



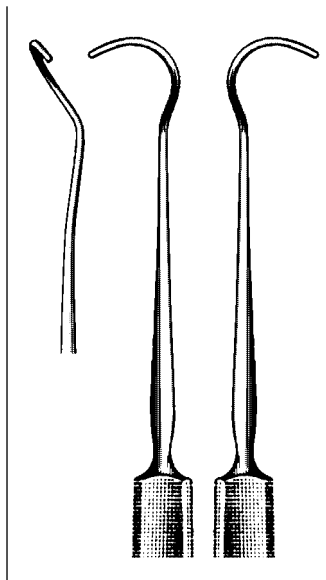
DESMARRES LID RETRACTOR

- 65-1841 #1 5½"
- 65-1842 #2 5½"
- 65-1843 #3 5½"
- 65-1844 #4 5½"



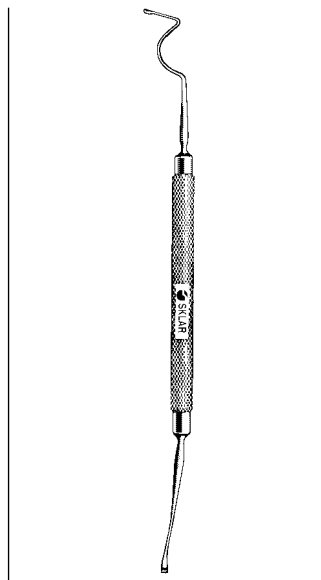
JAEGER LID PLATE

65-1835 3½" Plastic



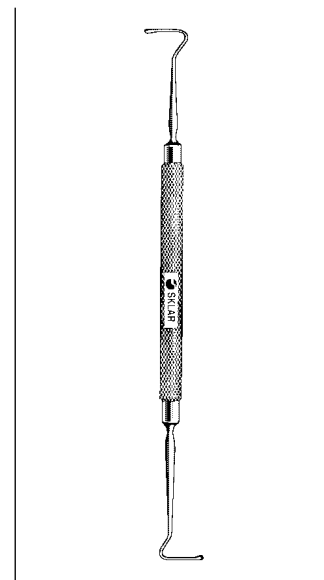
ARRUGA LENS EXPRESSORS

- 65-8350 Left
- 65-8352 Right



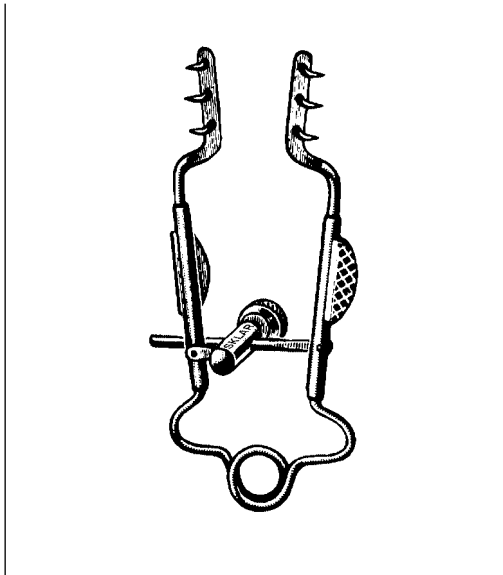
RIZZUTI IRIS RETRACTOR & LENS EXPRESSOR

14.5 cm
65-8354 2.5 mm blade



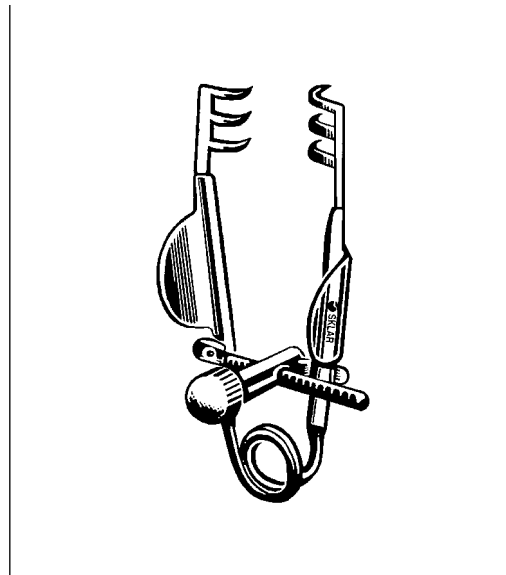
KIRBY MUSCLE HOOK & LENS EXPRESSOR

14.5 cm
65-9085 Double ended
10 x 2mm hooks



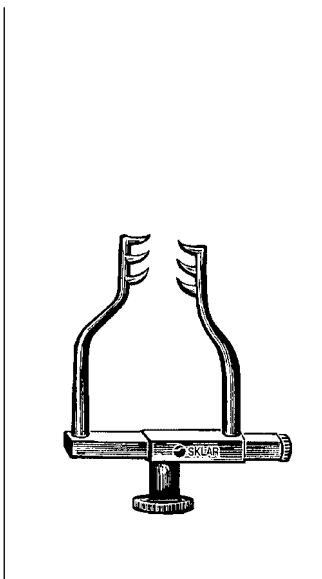
MELLER RETRACTOR

65-1830 3" (7.6 cm)



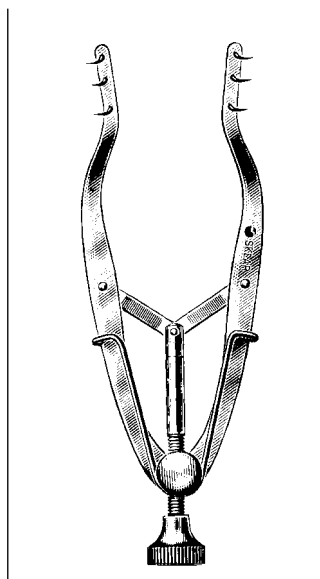
**SELF-RETAINING RETRACTOR
DELICATE**

65-1815 1½"



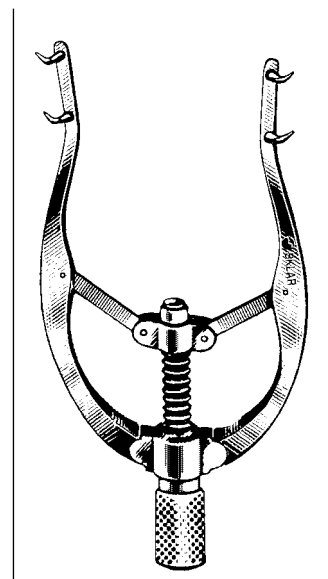
GOLDSTEIN RETRACTOR

47-2913 1½"



STEVENSON RETRACTOR

65-1831 3½"

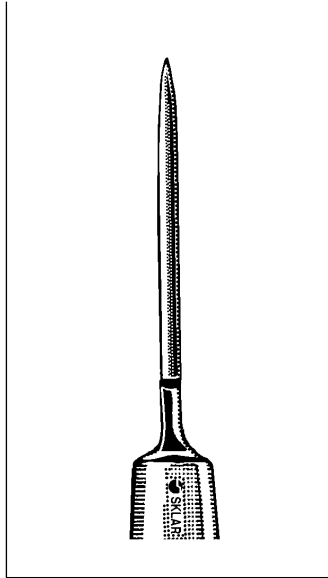


**WILDER SELF-RETAINING
RETRACTOR**

65-1825 2¾" 2 x 2 prong sharp
2 mm deep

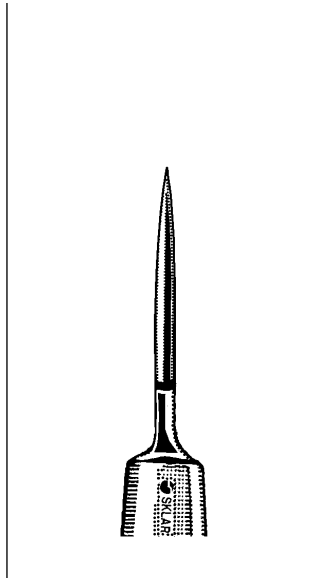
EYE INSTRUMENTS

KNIVES



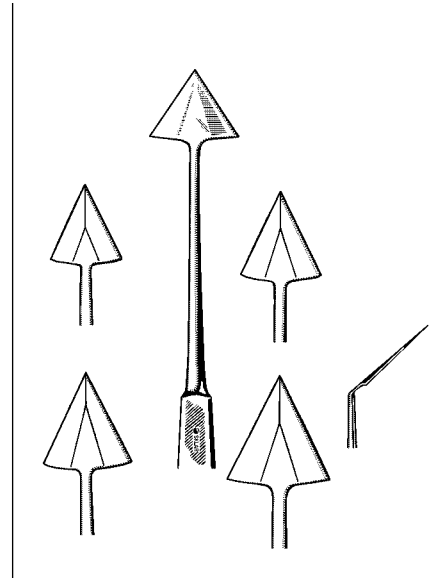
GRAEFE CATARACT KNIVES

- 65-3001 Small blade 1.7 mm x 27 mm
- 65-3002 Medium blade 2 mm x 30 mm
- 65-3003 Large blade 2.3 mm x 33 mm



WHEELER DISCISSION KNIFE

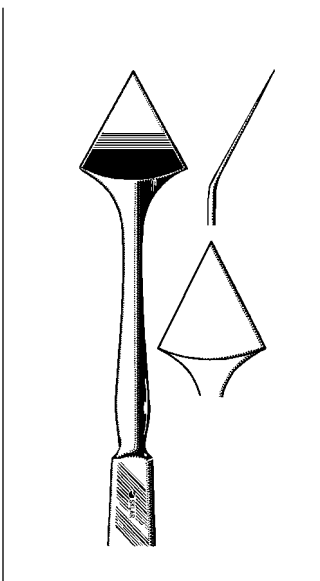
- 65-3010



GRIESHABER TYPE KERATOMES

Angular blade with beveled back

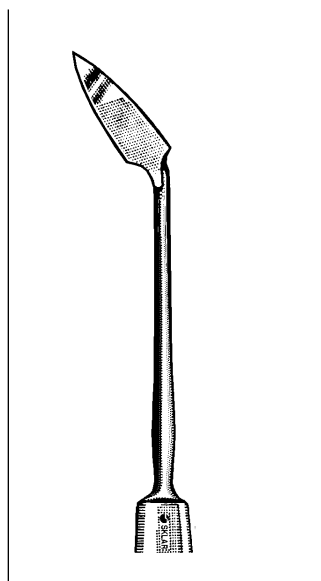
- 65-3050 Extra small, size 0
- 65-3051 Small, size 1
- 65-3052 Medium, size 2
- 65-3053 Large, size 3



JAEGER KERATOMES

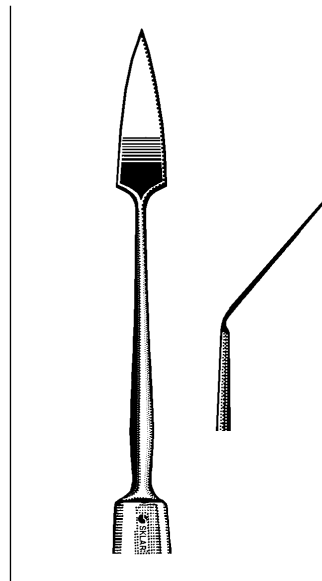
Angular blade

- 65-3040 Extra small, size 0 8 x 9.5
- 65-3041 Small, size 1 9.5 x 11
- 65-3042 Medium, size 2 11 x 12.5
- 65-3043 Large, size 3 12.5 x 14



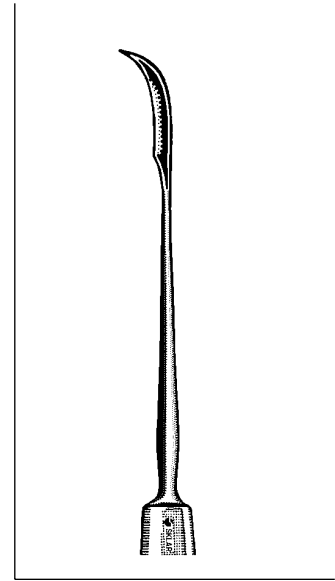
CASTROVIEJO KERATOME

- 65-3030 13 x 4 mm



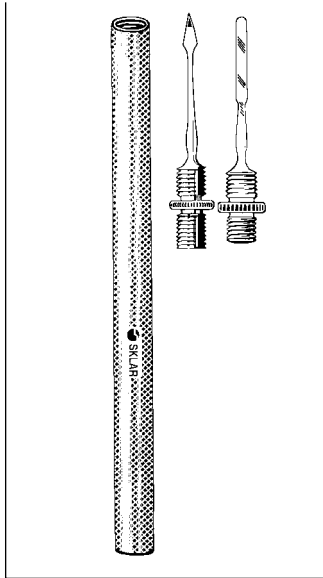
BERENS KERATOME

- 65-3060 19 x 3.25 mm



VON GRAEFE KNIFE NEEDLE

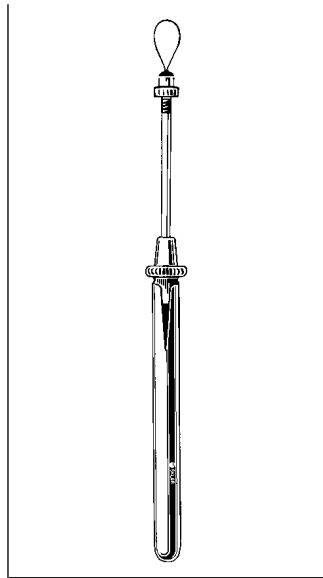
- 65-3062 Curved



DIX NEEDLE AND SPUD

Reversible Handle

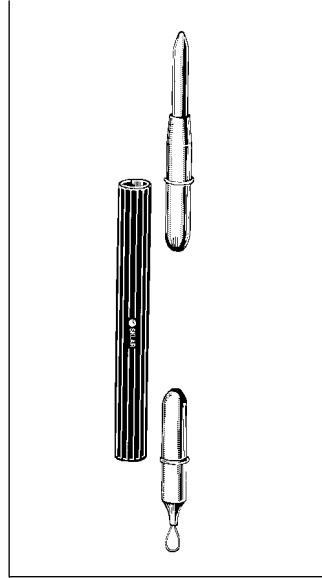
- 65-4030 Complete Chrome
- 65-4025 Needle, Blade Only
- 65-4026 Spud Only
- 65-4031 Single End Handle Only Chrome
- 65-4032 Double End Handle Only Chrome



BAILEY FOREIGN BODY REMOVER

Reversible Handle

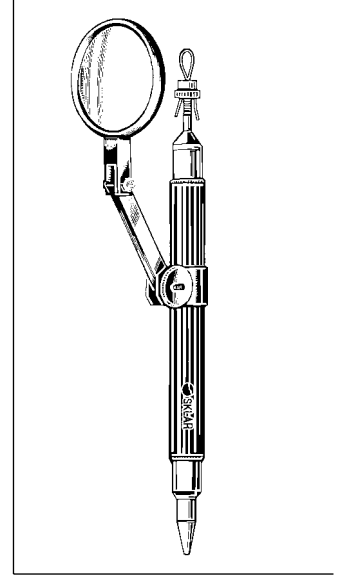
- 65-4080 Chrome Plated



JUNIOR MAGNETIC PROBE & FOREIGN BODY LOOP

Reversible Handle

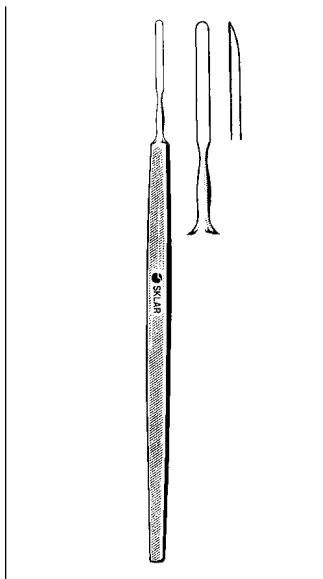
- 65-7422



JUNIOR MAGNETIC PROBE & FOREIGN BODY LOOP

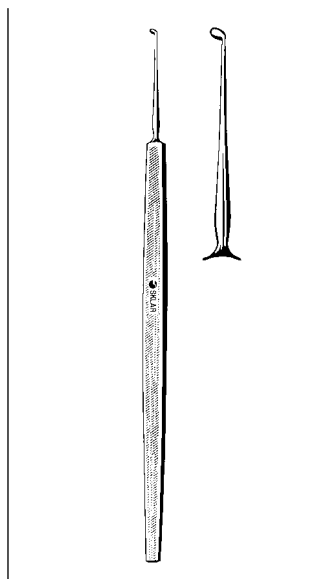
Reversible Handle

- 65-7425 With Magnifier Chrome
- Non-Autoclavable



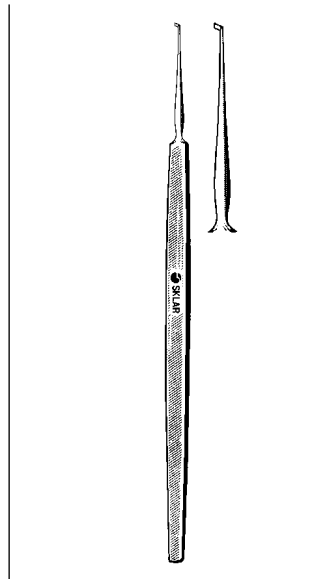
DIX FOREIGN BODY SPUD

- 65-7254 Blade beveled at tip



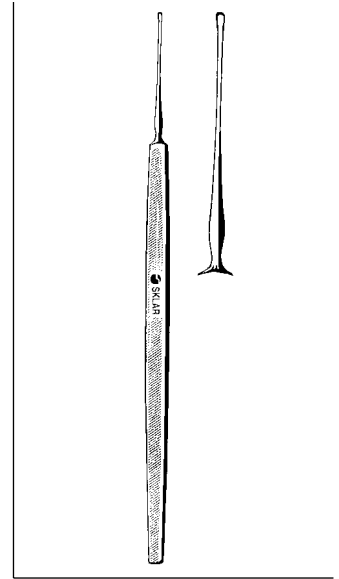
LAFORCE FOREIGN BODY SPUD

- 65-7255



FRANCIS FOREIGN BODY SPUD

- 65-7257 Flag-shaped blade



DAVIS FOREIGN BODY SPUD

- 65-7260 Chisel shape

EYE INSTRUMENTS

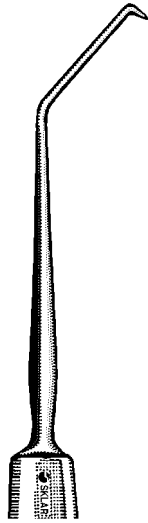
KNIVES



ZIEGLER KNIFE-NEEDLE

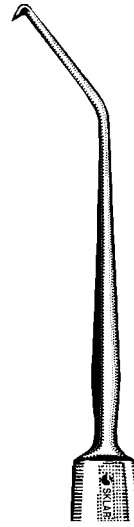
Angular blade

- 65-3094 4½" Size 0 3 mm blade
- 65-3095 4½" Size 1 5 mm blade
- 65-3096 4½" Size 2 6 mm blade
- 65-3097 4½" Size 3 7 mm blade



VON GRAEFE CYSTOTOME

65-3017 Angled right, flexible



VON GRAEFE CYSTOTOME

65-3018 Angled left, flexible



VON GRAEFE CYSTOTOME

65-3016 Straight, flexible



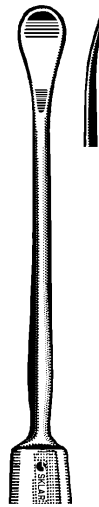
WILDER CYSTOTOME

65-3020 Flexible



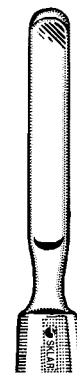
BARKAN GONIOTOMY KNIFE

65-3022 4½"



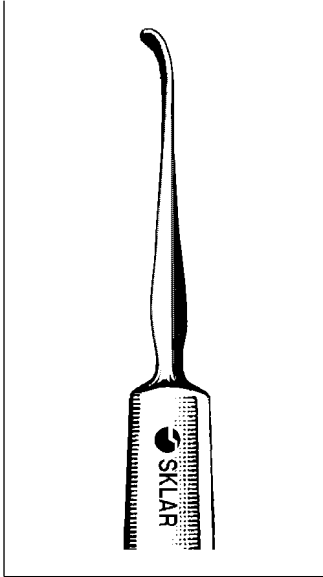
GILL CORNEAL KNIFE

65-3025 4¾" Blade is slightly curved on flat



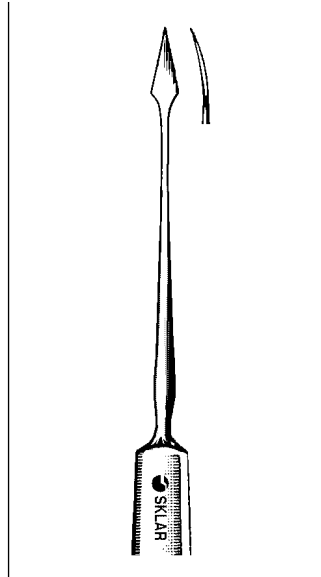
TOOKE CORNEAL KNIFE

65-3028 4½"



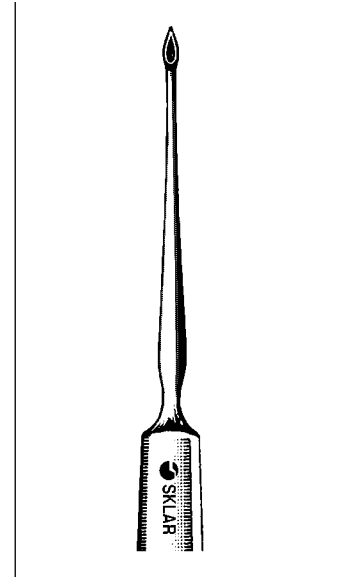
ELLIS FOREIGN BODY SPUD

Curved
65-7265 4½" 1.2 mm Blade



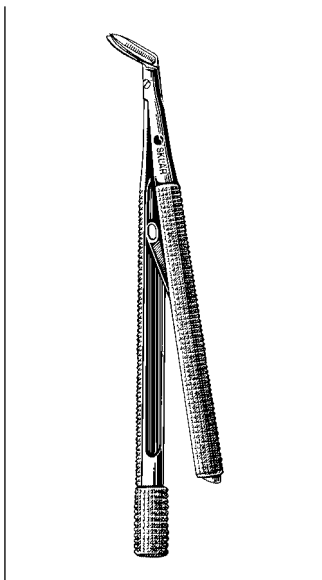
FOREIGN BODY NEEDLES

65-7270 Straight
65-7272 Curved



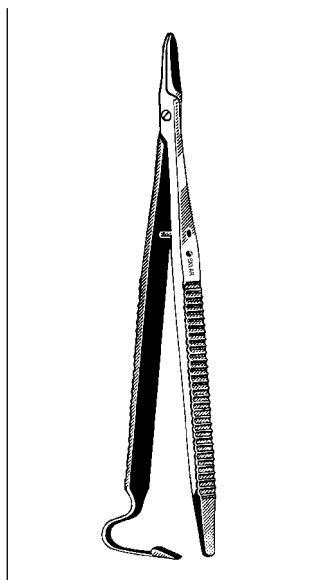
ALVIS FOREIGN BODY SPUD

With Fine Point
65-7275 4¾" 1 mm x 3 mm
Oval curette



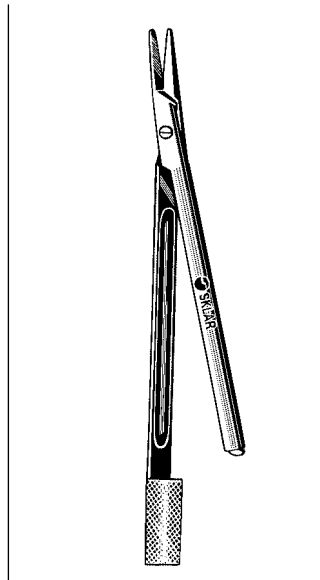
TROUTMAN BLADE BREAKER

65-2960 10 cm



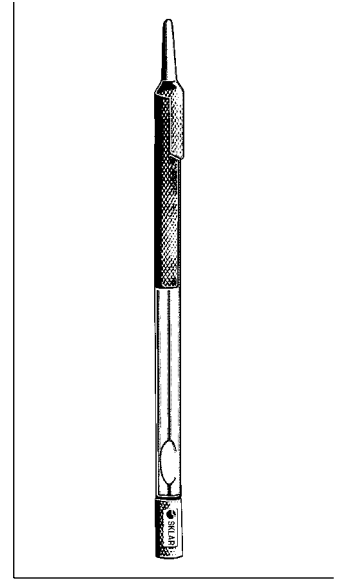
BARRAQUER BLADE BREAKER

65-2955 10.5 cm



CASTROVIEJO BLADE BREAKER

65-2950 10 cm

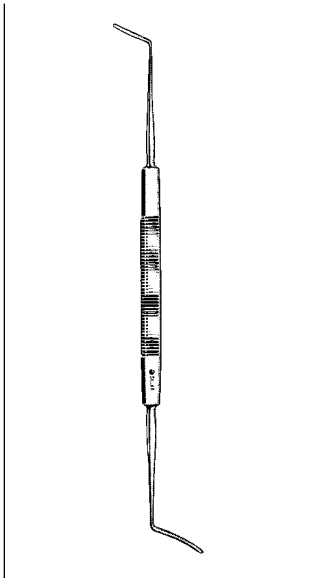


SWISS MODEL BLADE BREAKER

12 cm
65-2958 15 x 2.5 mm jaws

EYE INSTRUMENTS

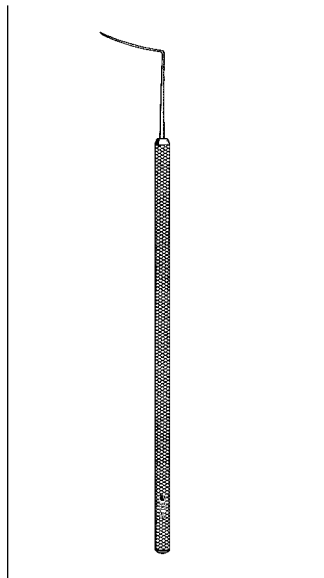
SPATULAS/SPOONS/HOOKS



CASTROVIEJO CYCLODIALYSIS SPATULAS

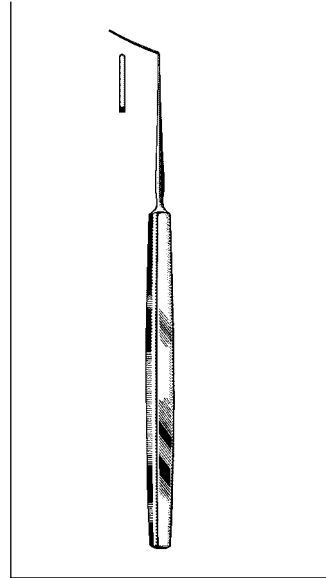
10 and 15 mm lengths
Double ended

65-4062 0.5 mm wide
65-4064 .75 mm wide
65-4066 1 mm wide



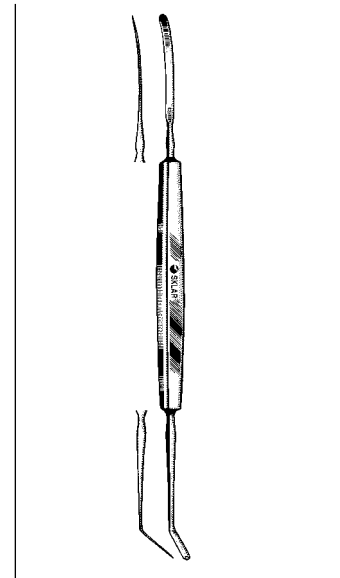
BARRAQUER CYCLODIALYSIS SPATULA

12 cm
65-4068 .50 mm diameter round
15 mm angled blade
Smooth pointed tip



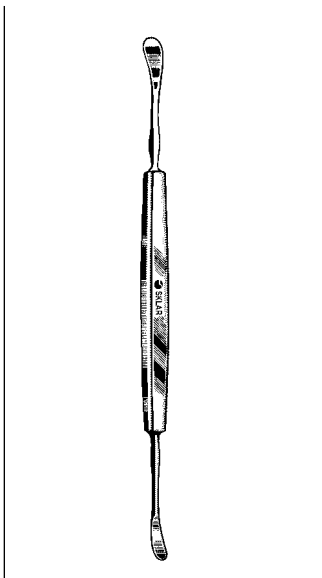
ELSCHMIG CYCLODIALYSIS SPATULA

65-4050 13 cm 10 mm x 1 mm



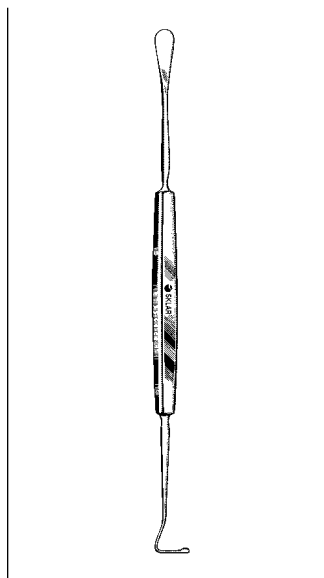
CASTROVIEJO CYCLODIALYSIS SPATULA

65-4070 5/8" Blade 10 x 1 mm
65-4072 5/8" Blade 15 x 1 mm



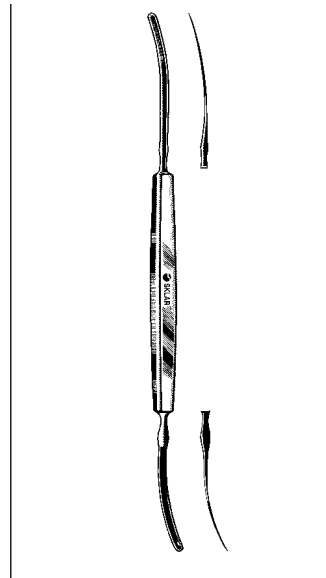
GREEN SPATULA

Slightly Curved
65-4074 6"



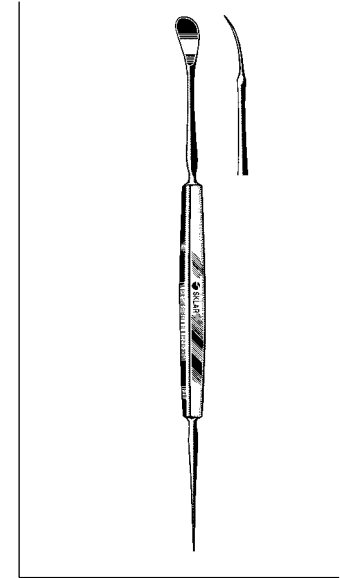
McREYNOLDS SPATULA AND HOOK

Double Ended
65-4076 4 3/4"



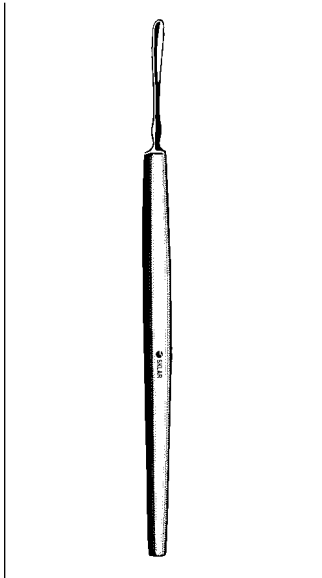
SMITH-FISHER IRIS SPATULA

One flat end, one spoon end
65-4078 5"



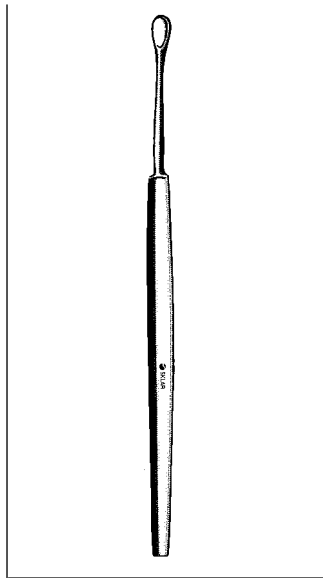
FISHER SPOON AND NEEDLE

65-4055 5/8" Spoon end 7 x 1 mm,
Needle 33 mm long



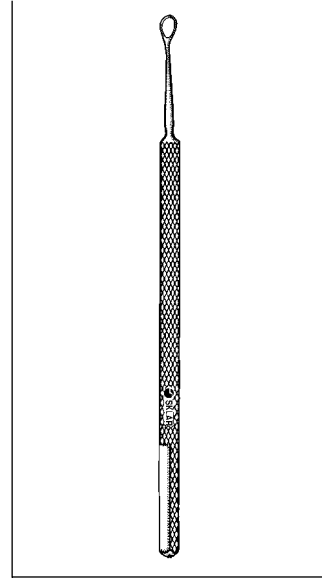
**DAVIEL CHALAZION
CURETTE**

12.5 cm
65-3140 3 mm spoon



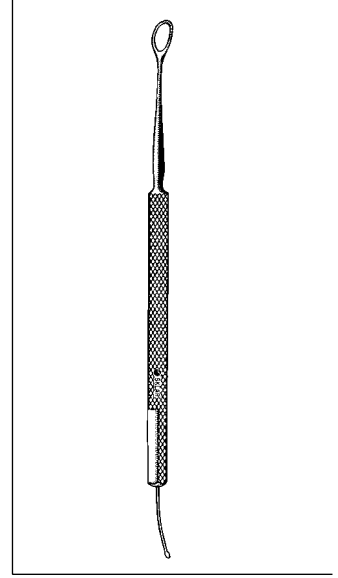
KNAPP LENS SCOOP

13.5 cm
65-8195 5 mm spoon



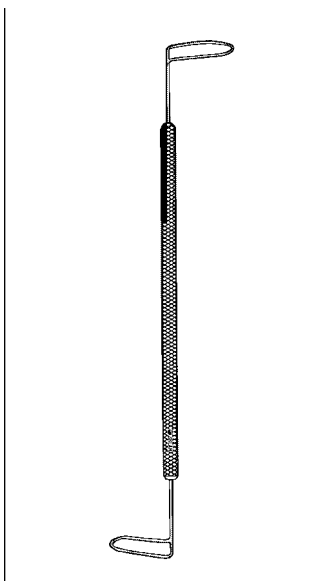
**GILLS/WELSH LENS
LOOP (MODIFIED)**

13.6 cm
65-3285 Ultra-thin blade



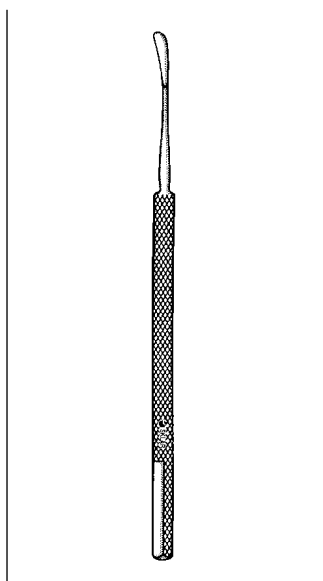
**GILLS/WELSH LENS
LOOP**

11.6 cm
65-3290 With Olive tip,
Ultra-thin blade
65-3292 With Olive tip, additional
20% curve on loop,
Ultra-thin blade



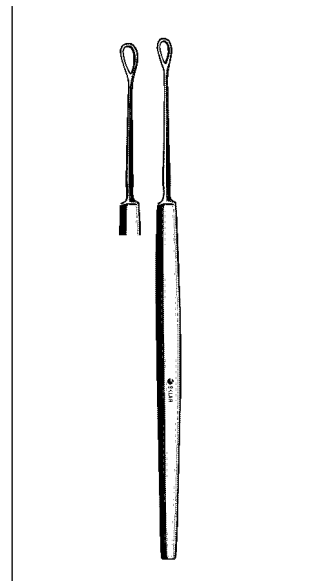
SIMCOE NUCLEUS LOOP

13.7 cm
65-3295 Double ended, serrated
loops, 4 mm x 20 mm



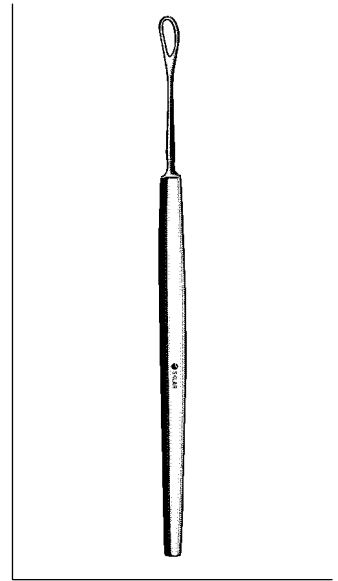
WILDER LENS LOOP

13.5 cm
65-8215 Serrated
65-8216 Smooth



LEWIS LENS LOOP

13.5 cm
65-8205 Serrated
65-8206 Smooth

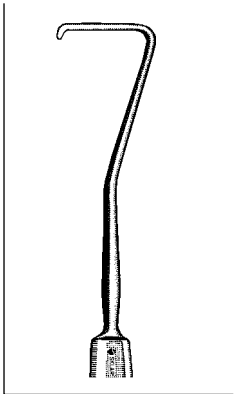


**NEW ORLEANS LENS
LOOP**

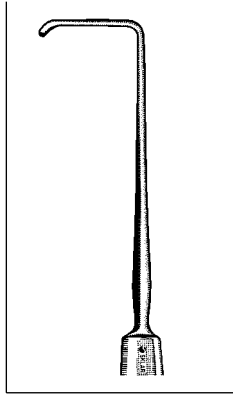
13.5 cm
65-8185 5 mm loop

EYE INSTRUMENTS

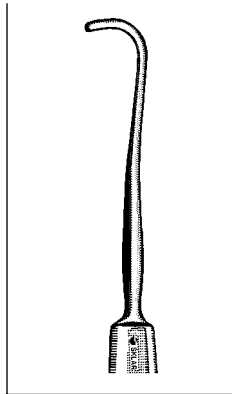
HOOKS/RETRACTORS



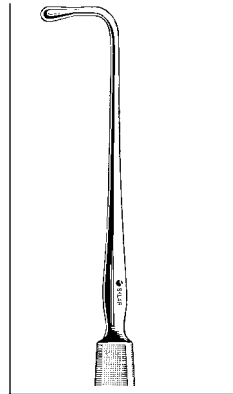
GREEN STRABISMUS HOOK
65-3200



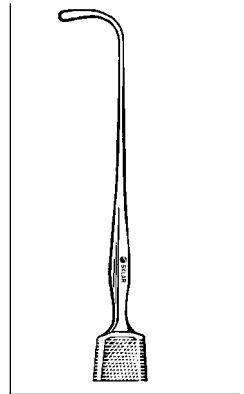
O'CONNOR FLAT TENOTOMY HOOK
65-3192



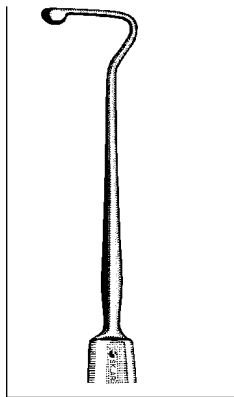
CULLER RECTUS MUSCLE HOOK
65-3198



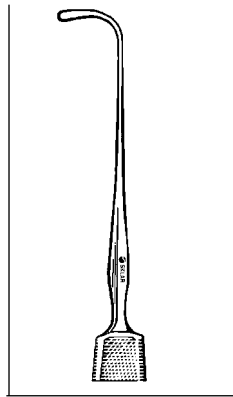
GRAEFE MUSCLE HOOK
65-3215 Small
65-3216 Medium
65-3217 Large



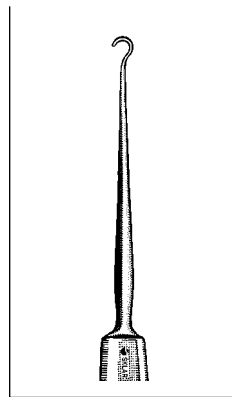
STEVENS TENOTOMY HOOK
65-3191



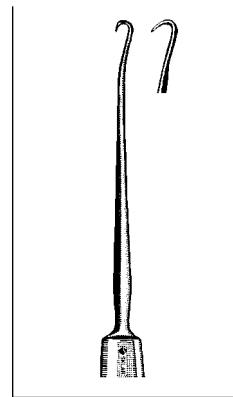
JAMISON MUSCLE HOOK
65-3195 5"
w/10 mm hook



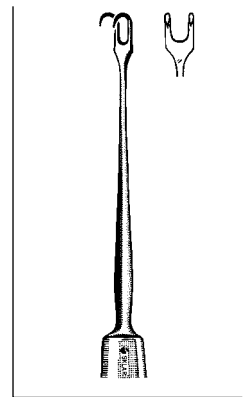
STEVENS TENOTOMY HOOK
65-3191



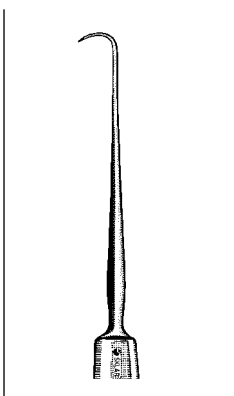
TYRELL IRIS HOOK
65-3205 Blunt
65-3206 Sharp



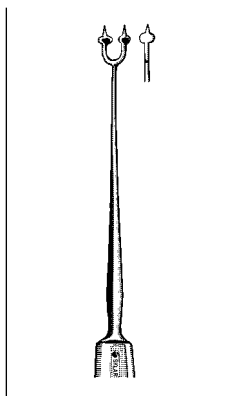
BERENS SCLERAL HOOK
65-3230 5" One sharp prong
65-3232 5" Two sharp prongs



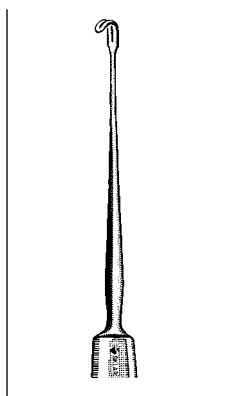
GUTHRIE FIXATION HOOK
47-2650 5" Two large prongs
47-2651 4 3/4" Two small prongs



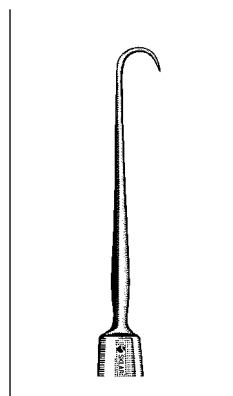
WIENER SCLERAL HOOK
65-3250 5" Sharp



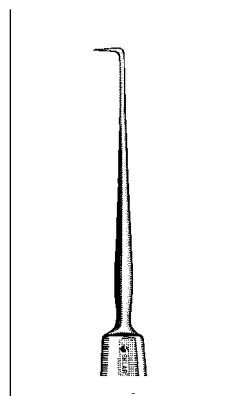
BURCH FIXATION PICK
65-3255 5/8" Stainless
Two prongs with stops to limit depth of penetration



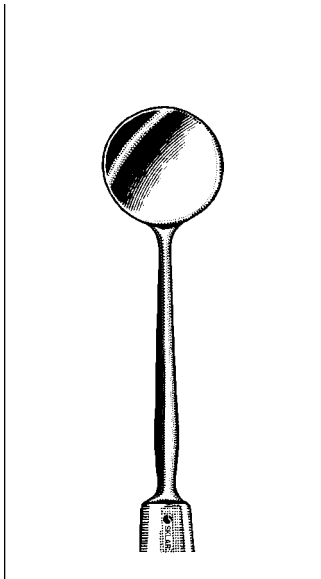
McGANNON IRIS RETRACTOR
65-3258 5/8"



O'CONNOR HOOK
65-3265 5" Sharp

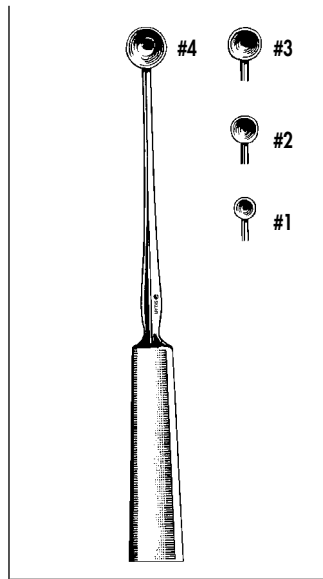


NUGENT IRIS HOOK
65-3270 5" Right Angled Sharp



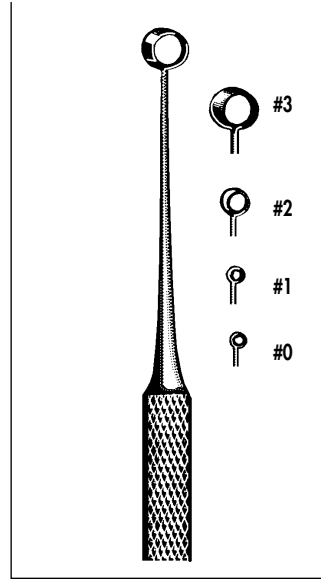
BUNGE EVISCERATION SPOONS

65-8151 Small
65-8155 Large



MEYHOEFER CHALAZION CURETTE

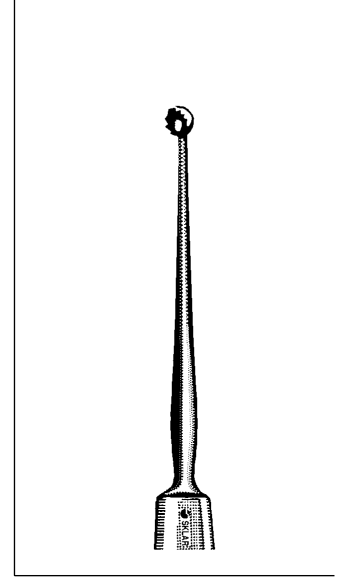
65-3170 #0 1.5 mm
65-3171 #1 1.7 mm
65-3172 #2 2.2 mm
65-3173 #3 2.5 mm
65-3174 #4 3.0 mm



HEATH CURETTE

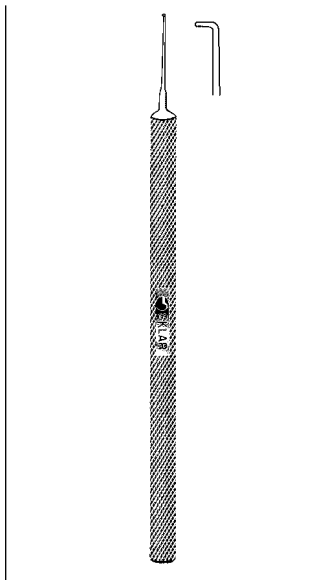
One Sharp Edge and One Dull Edge

65-3180 #0 ½ mm
65-3181 #1 1 mm
65-3182 #2 2 mm
65-3183 #3 3 mm



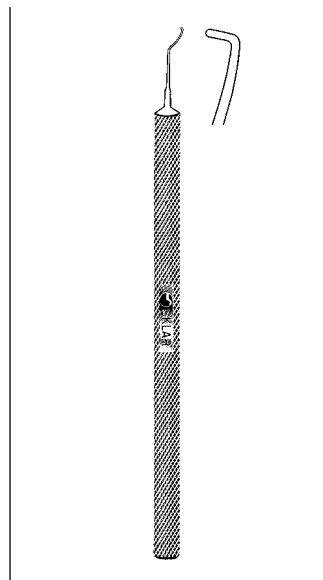
SKEELE CURETTE

65-3162 Serrated, 2 mm
Blade only, Stainless steel



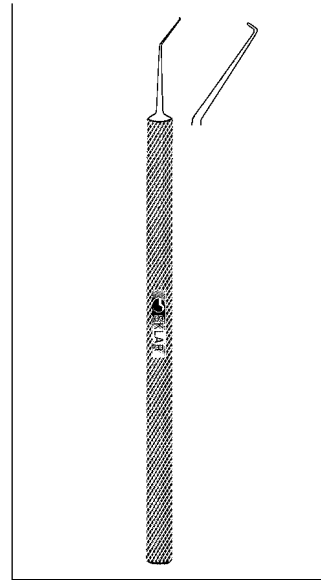
AZAR LENS MANIPULATING HOOK

66-7700 0.2 mm hook
Malleable shaft
11.8 cm



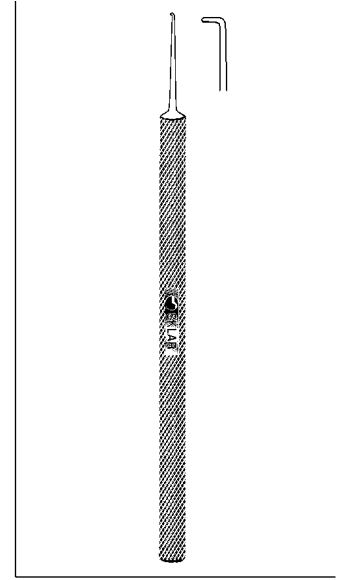
LEWICKI HOOK

66-7702 Curved 9 mm
90° angled tip
11.8 cm



CLAYMAN GUIDE

66-7704 9 mm with 0.2 mm hook
Angled 45°
11.8 cm

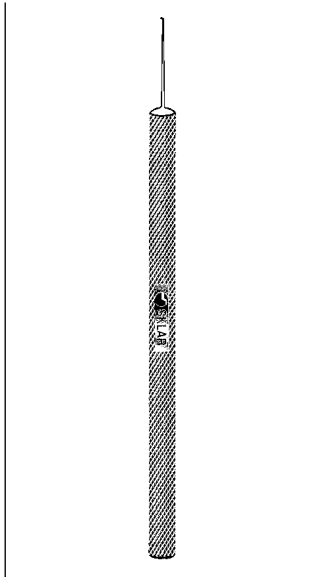


SINSKEY MICRO IRIS HOOK

Blunt
66-7710 0.25 mm dia.
Blunt tip Straight
66-7712 0.25 mm dia.
Blunt tip Angled 45°

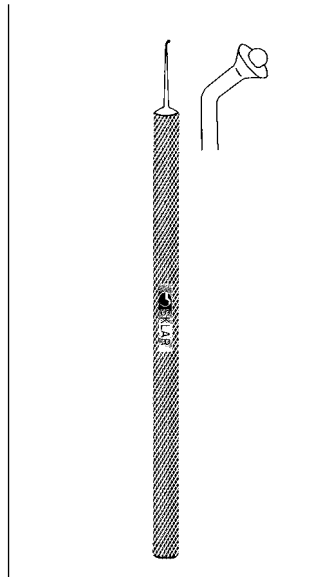
EYE INSTRUMENTS

LENS MANIPULATORS



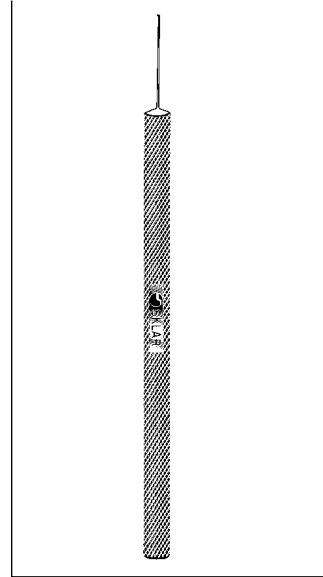
JAFFE LENS MANIPULATING HOOK

Blunt tip
66-7715 0.25 mm diameter



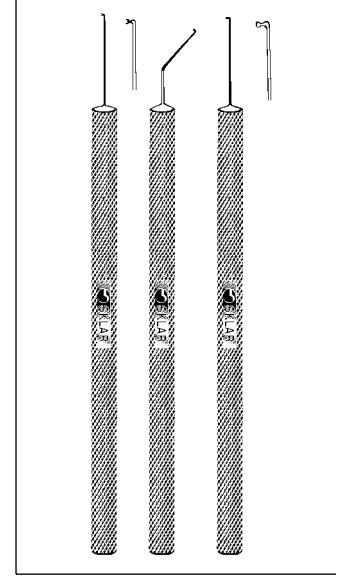
TENNANT ANCHOR LENS INSERTION HOOK

11.0 cm
66-7718 Angled .3 mm tip



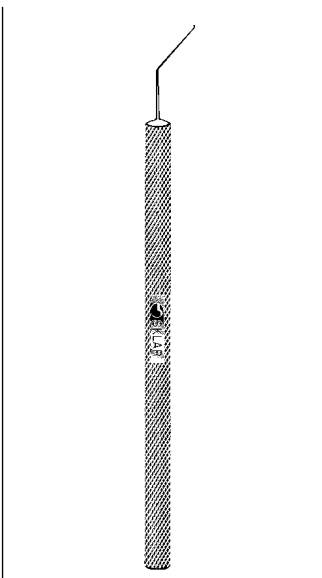
SINSKEY II & III LENS MANIPULATING HOOK

66-7720 0.2 mm dia. Blunt tip Straight
66-7721 0.2 mm dia. Blunt tip Angled 45°
66-7722 0.2 mm dia. Blunt tip Curved shank, for no hole IOL's
66-7723 0.2 mm dia. Blunt tip Curved shank, angled for no hole IOL's



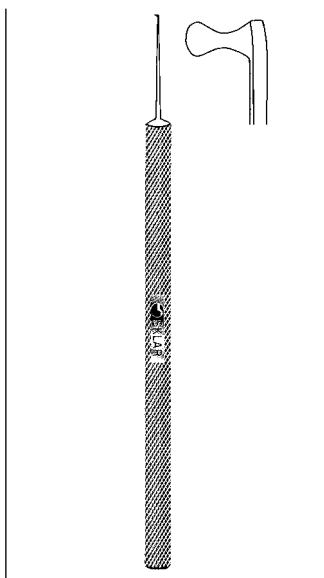
KUGLEN IRIS HOOK & LENS MANIPULATOR

Push Pull
66-7725 Straight
66-7726 Angled
66-7727 Cloverleaf



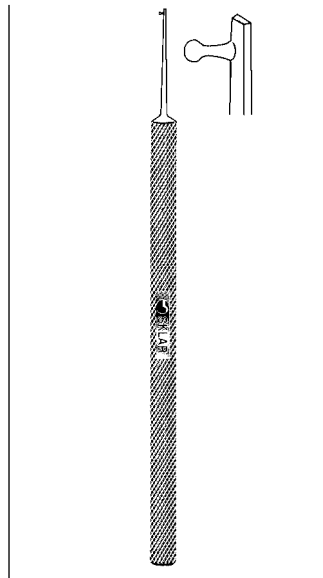
HARRIS-SINSKEY LENS MANIPULATING HOOK

Blunt, Angled
66-7735



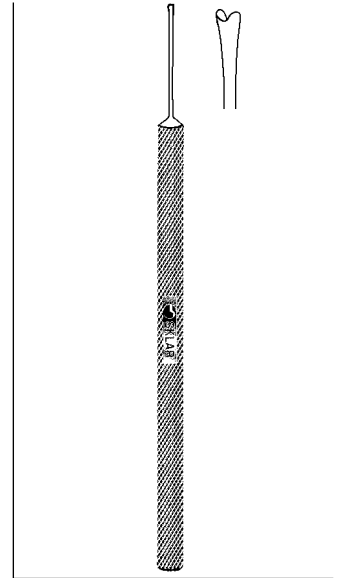
LESTER LENS MANIPULATOR

11.9 cm
66-7740 Straight
66-7742 Angled 45°



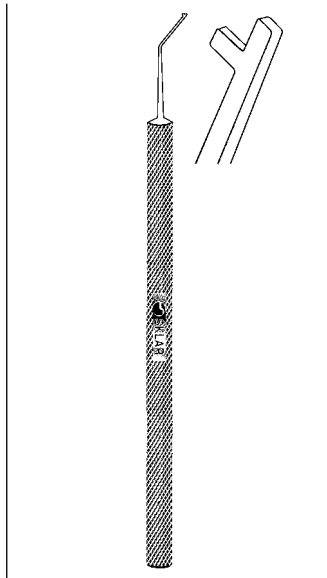
LESTER II LENS MANIPULATOR

11.7 cm
66-7750 Straight
66-7752 Angled 45°



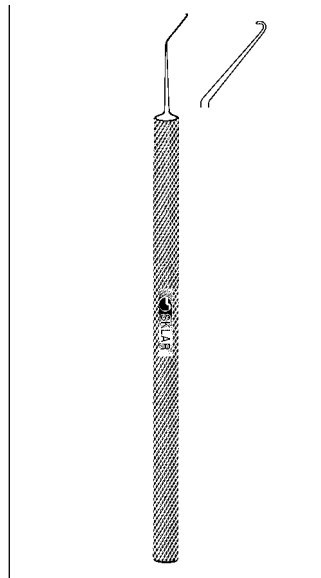
AKER LENS PUSHER

Smooth fish-mouth shaped jaws
66-7760 Straight
66-7762 Angled



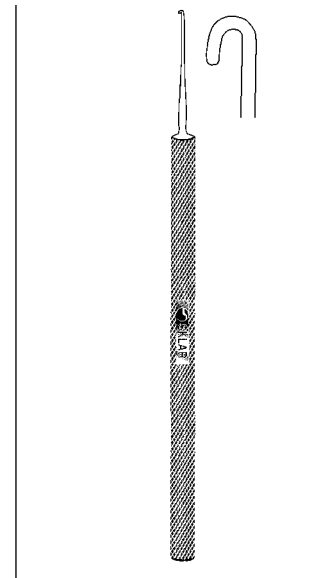
FENZL INSERTION HOOK

120 mm
66-7770 Angled 45° 10 mm to tip
0.2 mm hook



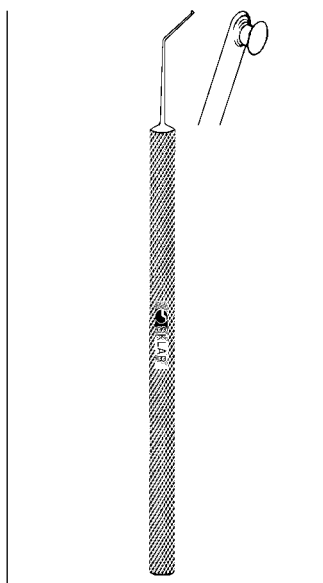
CLAYMAN IRIS HOOK

118 mm
66-7772 Angled 45° 9 mm to tip



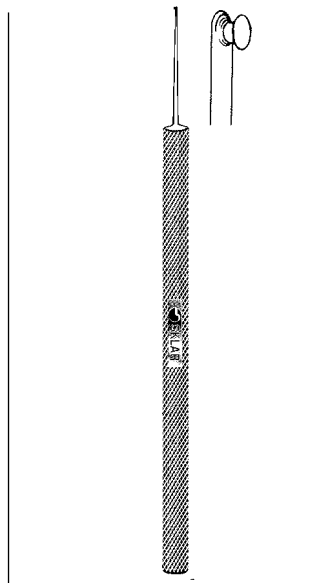
IRIS HOOK

125 mm
66-7775 Blunt



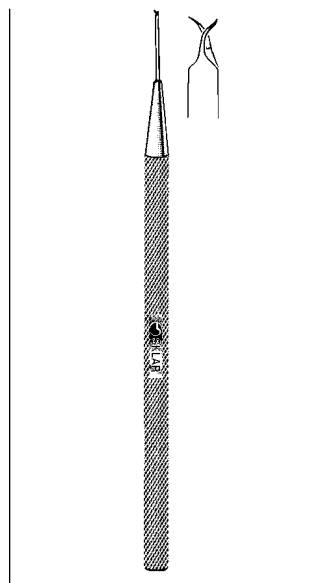
GRAETHER COLLAR BUTTON

66-7780 On handle, angled 45°
10 mm from bend to tip



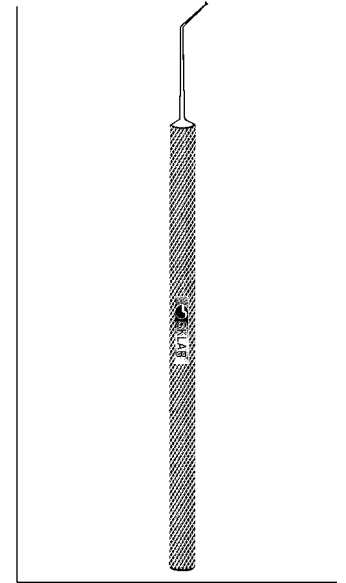
GRAETHER COLLAR BUTTON

66-7782 On handle, straight



SCLERAL TWIST FIXATION HOOK

11 cm
66-7790 Small 0.3 mm Right
66-7791 Small 0.3 mm Left
66-7792 Large 0.5 mm Right
66-7793 Large 0.5 mm Left

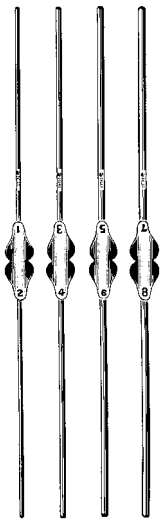


BECHERT NUCLEUS ROTATOR

124 mm
66-7795 Rotator on front of shaft

EYE INSTRUMENTS

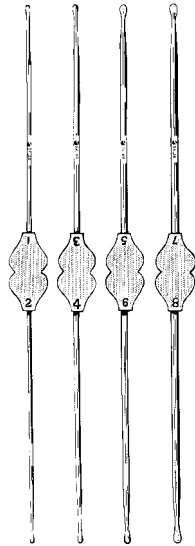
DILATORS



BOWMAN LACHRYMAL DILATORS

Double Ended

- 65-4100 Set of 4 #1 thru #8
- 65-4098 #0000/000
- 65-4099 #00/0
- 65-4101 #1-2
- 65-4103 #3-4
- 65-4105 #5-6
- 65-4107 #7-8



WILLIAMS LACHRYMAL DILATORS

Double Ended Sterling Silver

- 65-4120 Set of 4 #1 thru #8
- 65-4121 #1-2
- 65-4123 #3-4
- 65-4125 #5-6
- 65-4127 #7-8



WILDER LACHRYMAL DILATOR

- 65-7001 Short Taper
- 65-7002 Medium Taper
- 65-7003 Long Taper



INFANT LACHRYMAL DILATOR

- Extra Delicate 2 3/4"
- 65-7000 0.5 mm at tip



RUEDEMANN LACHRYMAL DILATOR

- 70 mm
- 65-6950 Short delicate needle tips



MULDOON LACHRYMAL DILATOR

- With Straight Distal End to Guide Dilator 4"
- 65-6952



CASTROVEIJO LACHRYMAL DILATOR

- Double Ended Tapers
- 22 mm x 18 mm 5 1/2"
- 65-6960



ZIEGLER LACHRYMAL DILATOR

- 14 mm
- 65-6965 Double ended Curved



**ELLIOT SCLERAL
TREPHINE**

66-7860



**CASTROVIEJO CORNEAL
TREPHINES**

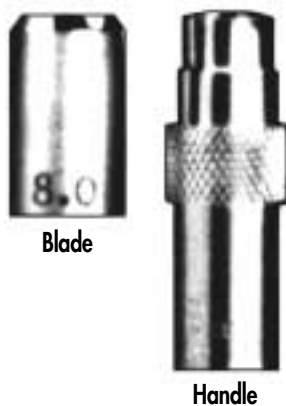
Adjustable with Guard

- 66-7862 5.0 mm diameter
- 66-7863 5.5 mm diameter
- 66-7864 6.0 mm diameter
- 66-7865 6.5 mm diameter
- 66-7866 7.0 mm diameter
- 66-7867 7.5 mm diameter
- 66-7868 8.0 mm diameter
- 66-7869 9.0 mm diameter
- 66-7870 10.0 mm diameter



**CORNEAL CUTTING
BLOCK**

66-7874



Blade

Handle

Packed Sterile



Short
Blade



Handle

Packed Sterile

CORNEAL TREPHINE BLADES AND HANDLES

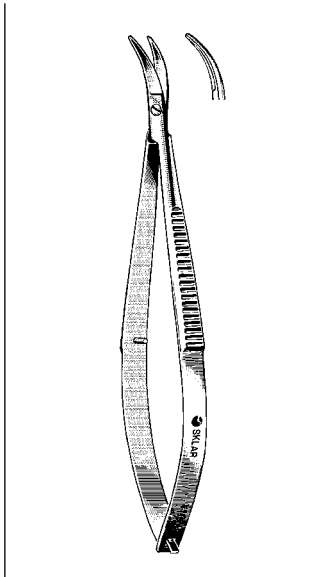
Blades	Diameter	Handles	Blades	Diameter	Handles
66-7875	6.0 mm	66-7900	66-7885	8.5 mm	66-7910
66-7876	6.2 mm	66-7901	66-7886	8.7 mm	66-7911
66-7877	6.5 mm	66-7902	66-7887	9.0 mm	66-7912
66-7878	6.7 mm	66-7903	66-7888	9.2 mm	66-7913
66-7879	7.0 mm	66-7904	66-7889	9.5 mm	66-7914
66-7880	7.2 mm	66-7905	66-7890	9.7 mm	66-7915
66-7881	7.5 mm	66-7906	66-7891	10.0 mm	66-7916
66-7882	7.7 mm	66-7907	66-7892	10.5 mm	66-7917
66-7883	8.0 mm	66-7908	66-7893	11.0 mm	66-7918
66-7884	8.2 mm	66-7909			

CORNEAL TREPHINE BLADES AND HANDLES (SHORT)

Blades	Diameter	Handles	Blades	Diameter	Handles
66-7925	6.0 mm	66-7950	66-7935	8.5 mm	66-7960
66-7926	6.2 mm	66-7951	66-7936	8.7 mm	66-7961
66-7927	6.5 mm	66-7952	66-7937	9.0 mm	66-7962
66-7928	6.7 mm	66-7953	66-7938	9.2 mm	66-7963
66-7929	7.0 mm	66-7954	66-7939	9.5 mm	66-7964
66-7930	7.2 mm	66-7955	66-7940	9.7 mm	66-7965
66-7931	7.5 mm	66-7956	66-7941	10.0 mm	66-7966
66-7932	7.7 mm	66-7957	66-7942	10.5 mm	66-7967
66-7933	8.0 mm	66-7958	66-7943	11.0 mm	66-7968
66-7934	8.2 mm	66-7959			

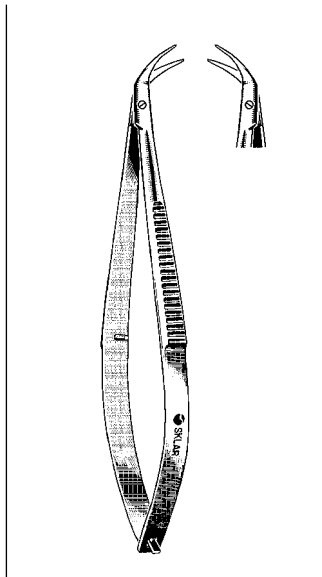
EYE INSTRUMENTS

CORNEAL SCISSORS



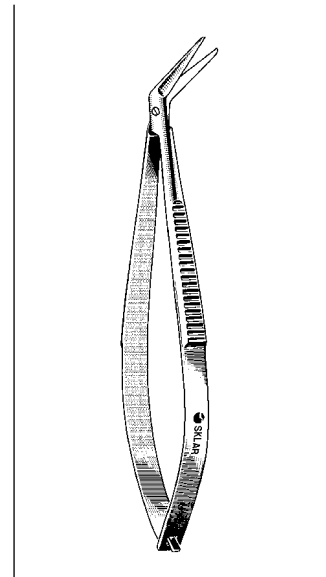
CASTROVIEJO CORNEAL SCISSORS

64-2442 4 1/4" Curved blunt blades
Spring Handles



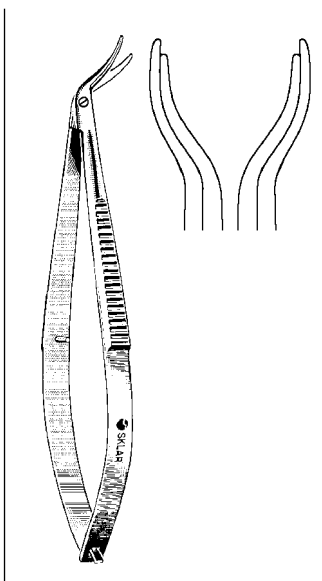
CASTROVIEJO CORNEAL SCISSORS

Miniature with inner blade 0.5 mm
longer than outer blade
64-2242 4 1/4" Curved right
64-2342 4 1/4" Curved left



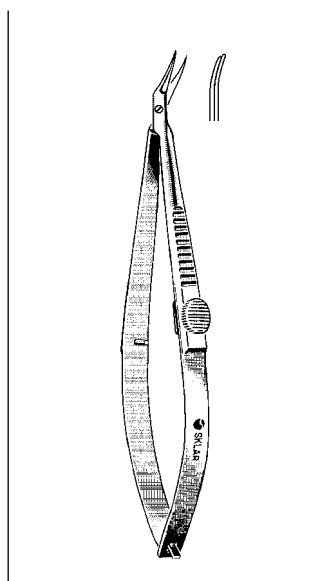
CASTROVIEJO CORNEAL SCISSORS

64-2535 3 1/2" 13 mm blunt angled
blades



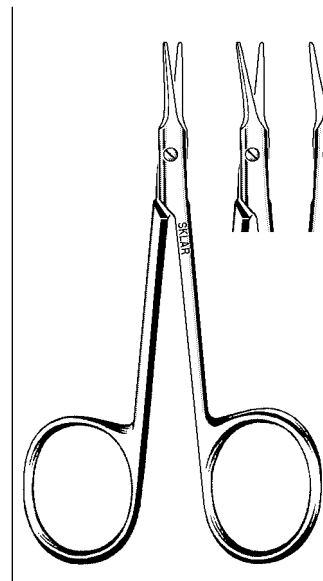
CASTROVIEJO CATARACT SCISSORS

64-3290 4" Angled blades to facilitate
manipulation and curved to conform to the curve of the
limbus; curved right
64-3292 4" Longer blade rounded to minimize
trauma to corneal endothelium and iris. Curved left.



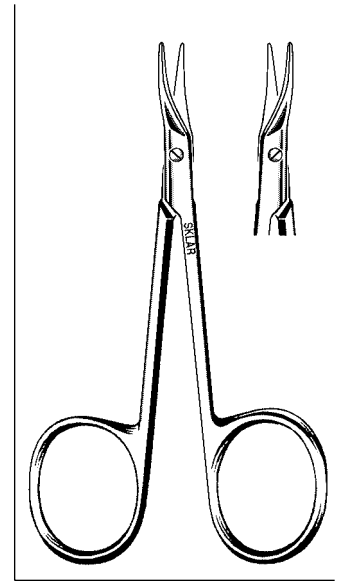
CASTROVIEJO CORNEAL SCISSORS

Right sub-miniature for micro
surgery
64-3294 4" right
64-3296 4" left



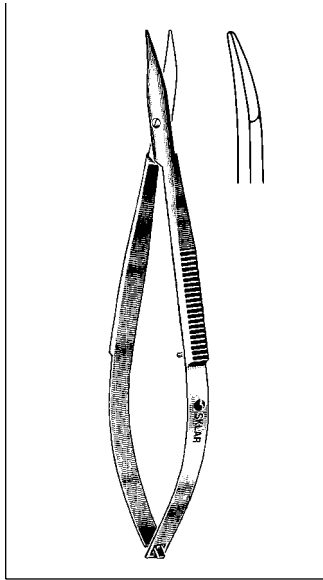
AEBLI CORNEAL SCISSORS

64-3270 4" Straight
64-3272 4" Angled on flat, right
64-3274 4" Angled on flat, left



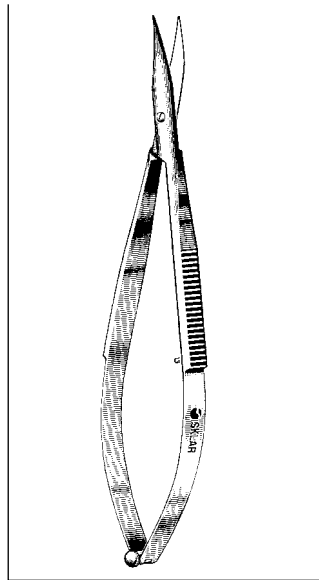
MCGUIRE CORNEAL SCISSORS

64-3297 4 1/4" 16 mm delicate sharp
blades right
64-3298 4 1/4" 16 mm delicate sharp
blades left



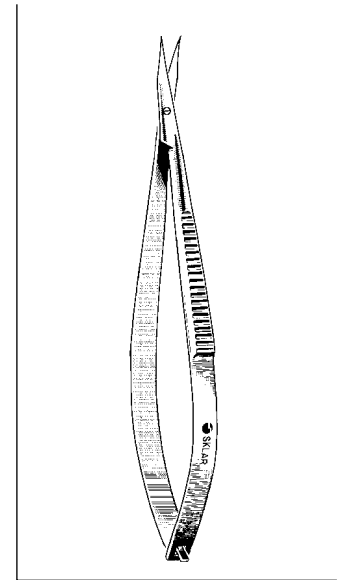
**WESTCOTT TENOTOMY
SCISSORS**

64-3146 4½" Blunt tips with spring
handle



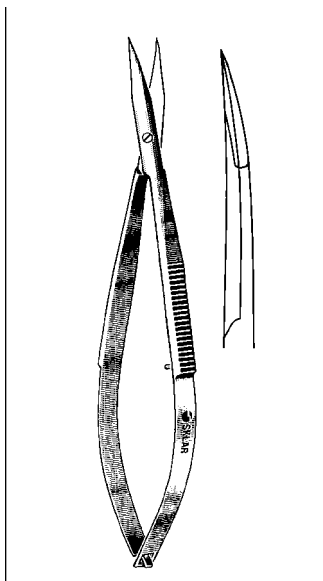
**WESTCOTT TENOTOMY
SCISSORS**

64-3142 5" Right
64-3144 5" Left



**SHEPARD-WESTCOTT
SCISSORS**

Serrated upper blade
64-3148 4½"



WESTCOTT SCISSORS

64-3145 4½" Sharp tips with spring
handle

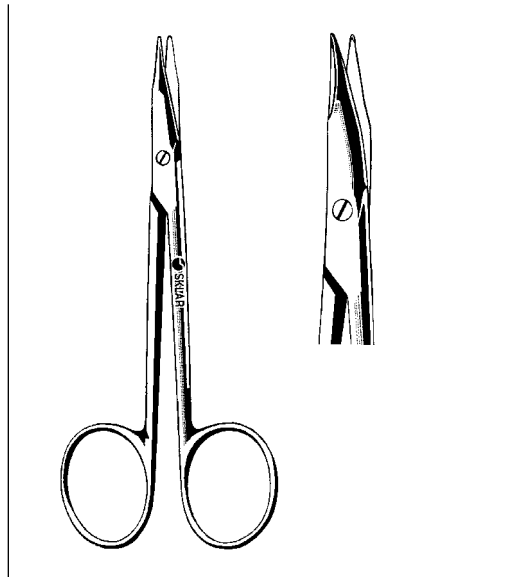


SCHIEE-WESTCOTT CORNEAL SECTION SCISSORS

64-3138 5" Right
64-3140 5" Left

EYE INSTRUMENTS

TENOTOMY SCISSORS



STEVENS TENOTOMY SCISSORS

Straight	Curved
64-1242 4¼" B/B	64-1342 4¼" B/B



SKLARLITE
THE LIGHT TOUCH

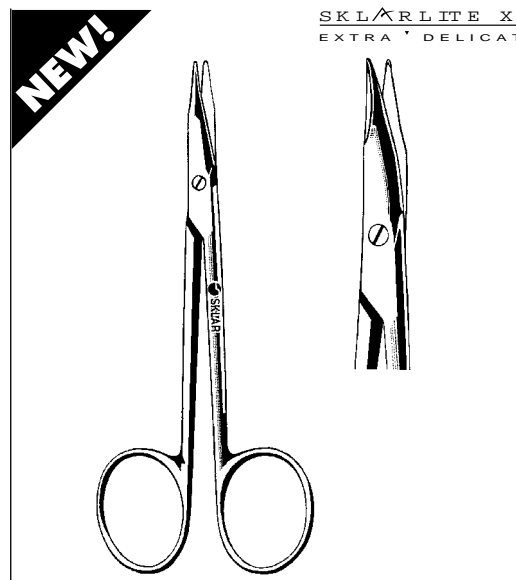
SKLARLITE STEVENS TENOTOMY SCISSORS

Straight	Curved
23-1156 4¼" B/B	23-1157 4¼" B/B



STEVENS TENOTOMY SCISSORS DELICATE

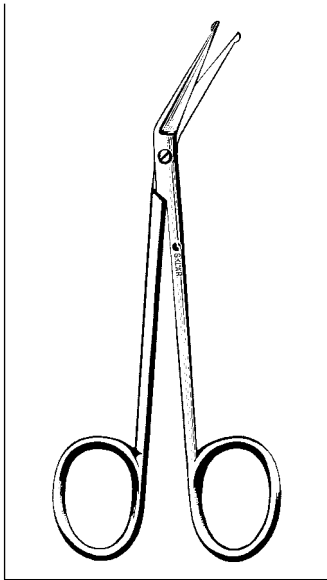
Straight	Curved
22-1242 4¼" B/B	22-1342 4¼" B/B
22-1240 4¼" S/S	22-1241 4¼" S/S



SKLARLITE XD
EXTRA DELICATE

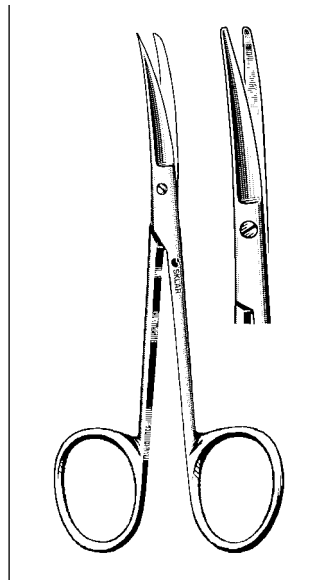
SKLARLITE EXTRA DELICATE STEVENS TENOTOMY SCISSORS

Straight	Curved
23-1160 4¼" B/B	23-1161 4¼" B/B



**ANGULAR IRIS SCISSORS
PROBE POINT**

64-2042 4 1/4"

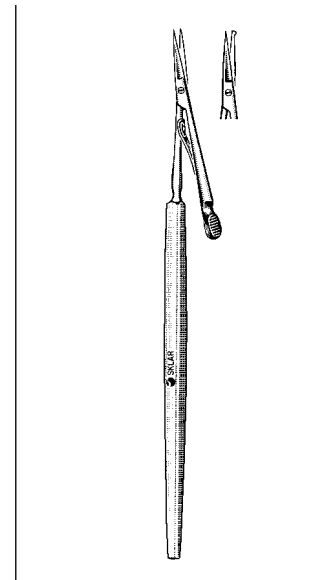


KNAPP IRIS SCISSORS

Curved

64-3230 4" Sharp/Blunt

64-3235 4" Blunt/Blunt

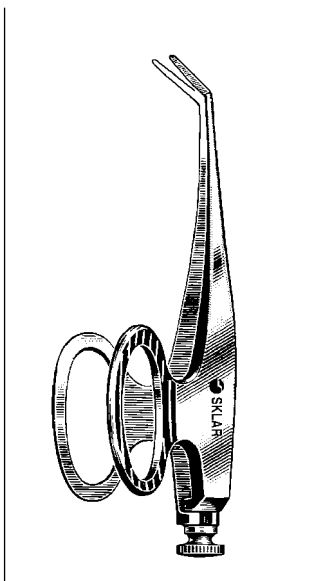


**NOYES IRIDECTOMY
SCISSORS**

Straight

64-2555 5 1/2" Sharp/Sharp

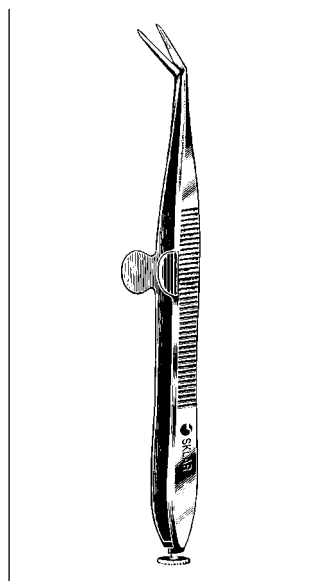
64-2655 5 1/2" Sharp/Probe Point



**BARRAQUER-DEWECKER
IRIS SCISSORS**

64-3225 2 1/4" Fine 7 mm blades

64-3228 2 1/4" Delicate 10 mm blades

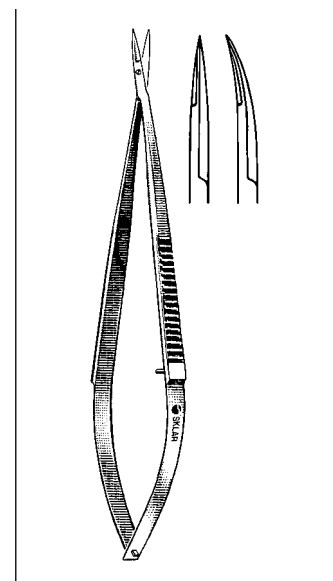


**DEWECKER IRIS
SCISSORS**

Angled

64-3042 4 1/4" Sharp/Blunt

64-2942 4 1/4" Sharp/Sharp



**IRIS MICRO-MINIATURE
SCISSORS**

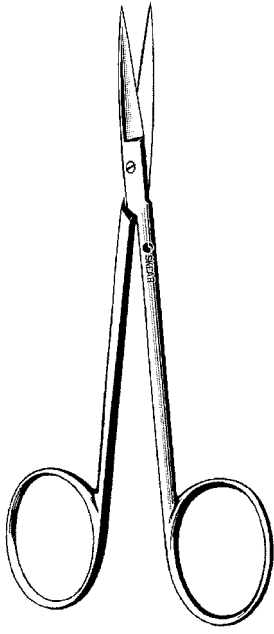
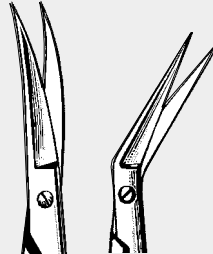
Extra delicate, sharp points

64-3050 4" Straight

64-3052 4" Curved

EYE INSTRUMENTS

IRIS SCISSORS

IRIS SCISSORS

Straight
 47-1135 S/S 3½"
 47-1140 B/B 3½"
 47-1145 S/S 4½"
 47-1144 B/B 4½"

Curved
 47-1235 S/S 3½"
 47-1240 B/B 3½"
 47-1245 S/S 4½"
 47-1244 B/B 4½"

Angular
 64-2142 S/S 4½"



NEW!



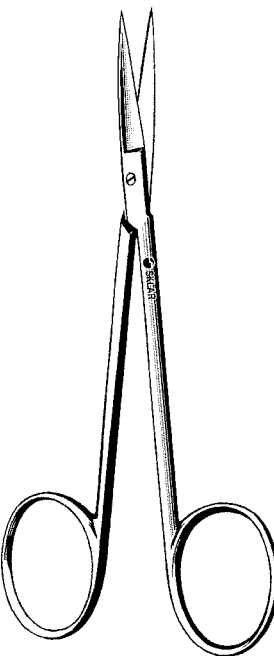
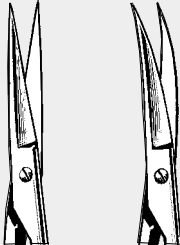
**SKLARLITE
IRIS SCISSORS**

Straight
 23-1148 S/S 3½"
 23-1149 S/S 4½"

Curved
 23-1150 S/S 3½"
 23-1151 S/S 4½"

SKLARLITE
THE LIGHT TOUCH

*Sklarlite XD™ Scissors Deliver
The Ultimate In Precision*

**IRIS SCISSORS
DELICATE**

Straight
 22-1135 S/S 3½"
 47-1246 S/S 4⅛"

Curved
 22-1235 S/S 3½"
 47-1248 S/S 4⅛"



NEW!

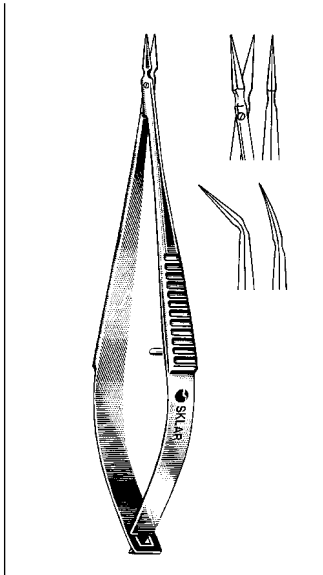


**SKLARLITE
EXTRA DELICATE
IRIS SCISSORS**

Straight
 23-1152 S/S 3½"
 23-1153 S/S 4⅛"

Curved
 23-1154 S/S 3½"
 23-1155 S/S 4⅛"

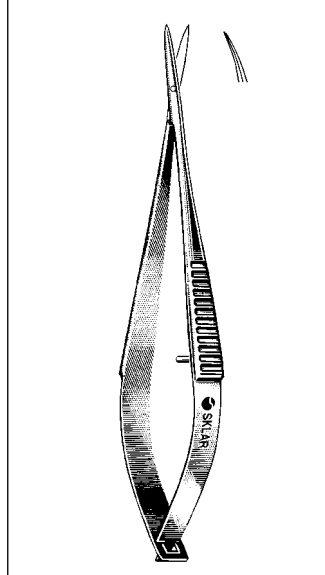
SKLARLITE XD
EXTRA DELICATE



VANNAS SPRING HANDLE SCISSORS

Very Delicate

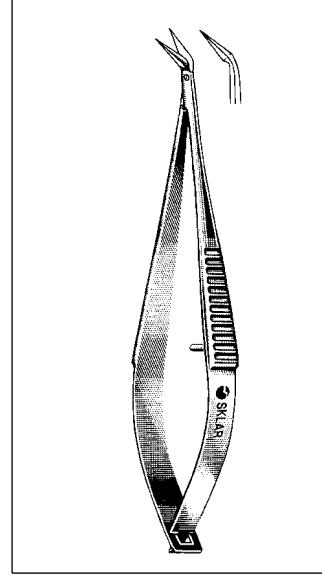
- 64-1950 3" Straight
- 64-1951 3" Curved
- 64-1952 3" Angular



McPHERSON-VANNAS SCISSORS

Very Delicate

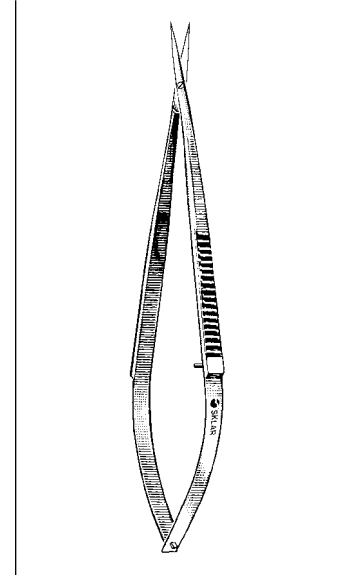
- 64-1960 3" Straight
- 64-1961 3" Curved



VANNAS SCISSORS

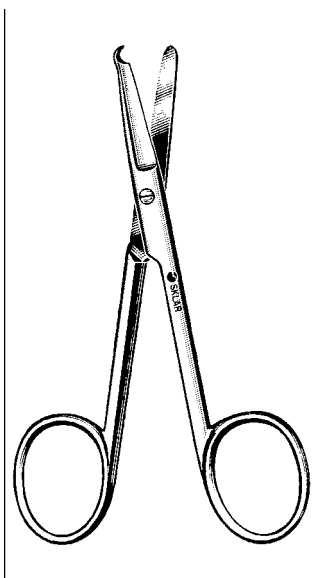
Extremely delicate blades with spring handle

- 64-1955 Angled on flat
- 64-1958 Angled to side



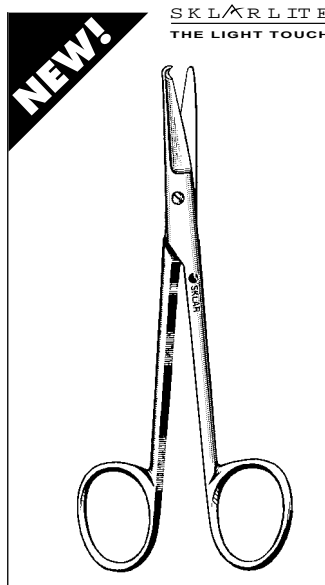
FINE STITCH SCISSORS

- 64-3260 4 1/4" Delicate Sharp blades



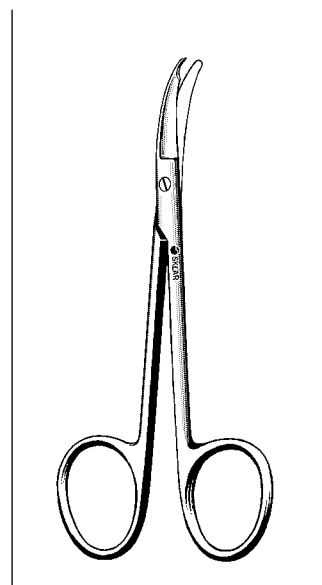
SPENCER STITCH SCISSORS

- 22-2835 3 1/2"
- 22-2845 4 1/2"
- 15-1355 5 1/2" Littauer



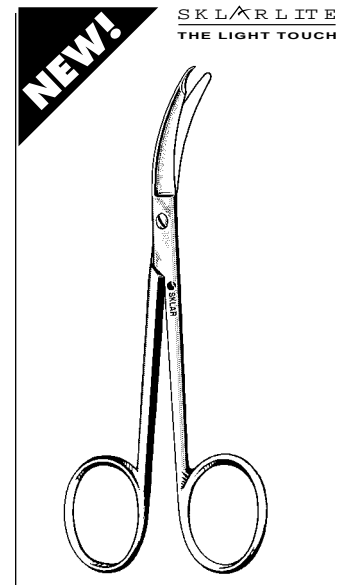
SKLARLITE SPENCER STITCH SCISSORS

- 23-1188 3 1/2"
- 23-1189 4 1/2"
- 23-1190 5 1/2" Littauer



SUTURE SCISSORS

- 22-2935 3 1/2" Shortbent
- 22-2947 4 3/4" Northbent

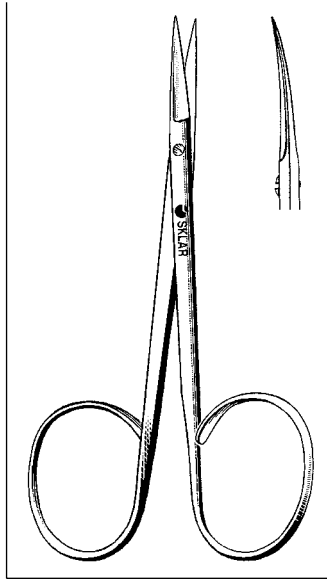


SKLARLITE SUTURE SCISSORS

- 23-1191 3 1/2" Shortbent

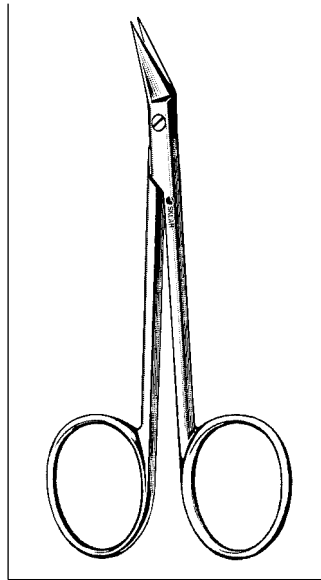
EYE INSTRUMENTS

IRIS/STITCH SCISSORS



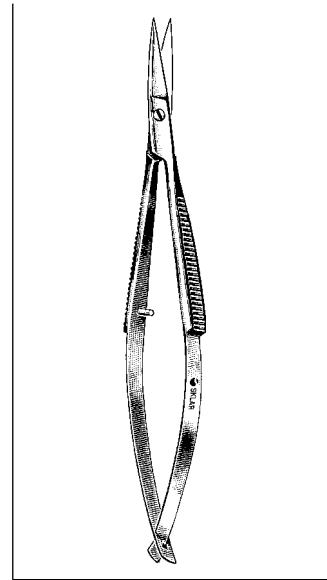
RIBBON IRIS SCISSORS

Straight 47-1250 4"
Curved 47-1255 4"



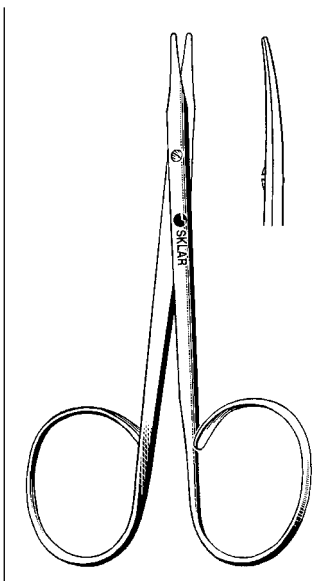
WILMER SCISSORS

Angular 64-1735 4"



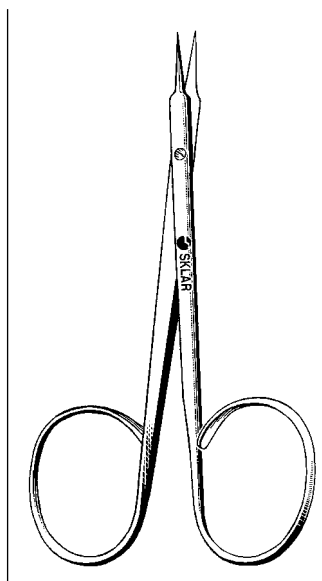
McCLURE SPRING HANDLE SCISSORS

64-1742 4 1/4" Angled
64-1842 4 1/4" Straight
64-1942 4 1/4" Curved



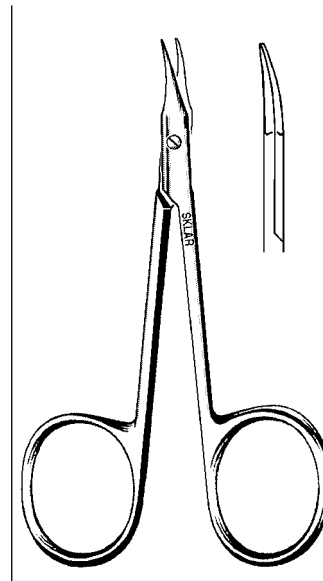
RIBBON STEVENS TENOTOMY SCISSORS

Straight 64-1241 4"
Curved 64-1351 4"



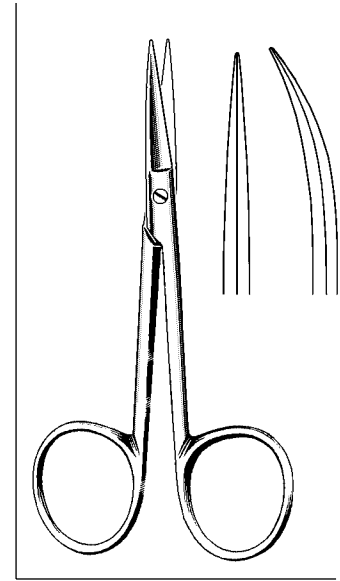
RIBBON STITCH SCISSORS

64-1345 4"



GRADLE SCISSORS

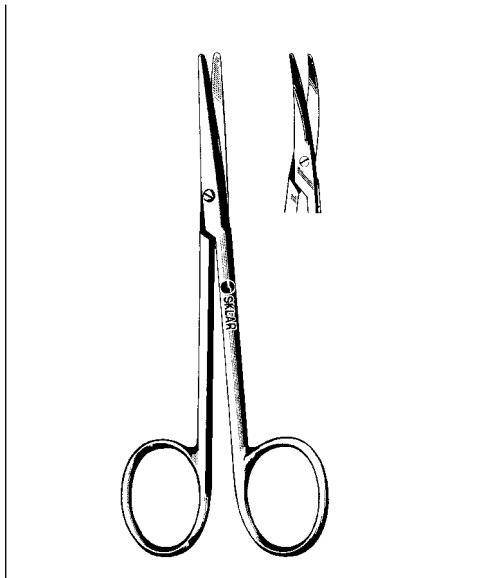
Slightly curved, Sharp 64-3280 3 1/4"



SEALY DISSECTING SCISSORS

Two blunt tips, Medium weight
Delicate blades

64-3285 4 1/4" Straight
64-3288 4 1/4" Curved



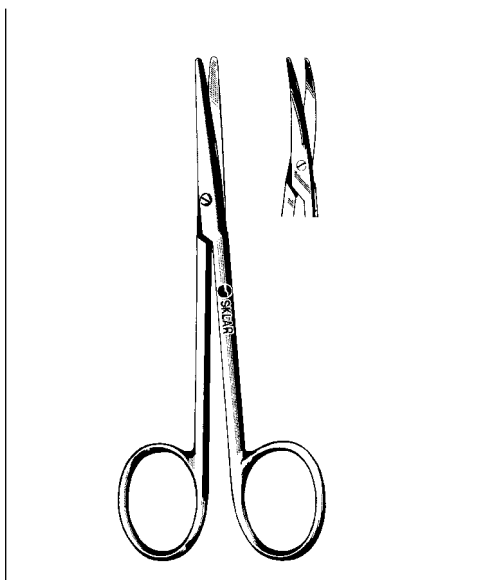
STRABISMUS SCISSORS

Straight	Curved
64-1442 4¼"	64-1542 4¼"



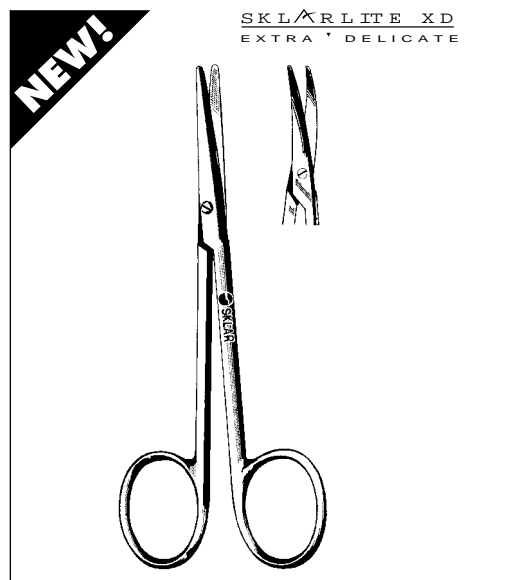
SKLARLITE STRABISMUS SCISSORS

Straight	Curved
23-1158 4¼"	23-1159 4¼"



STRABISMUS SCISSORS DELICATE

Straight	Curved
22-1442 4¼"	22-1542 4¼"

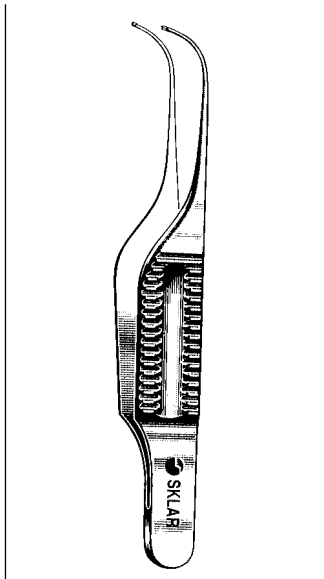


SKLARLITE EXTRA DELICATE STRABISMUS SCISSORS

Straight	Curved
23-1162 4¼"	23-1163 4¼"

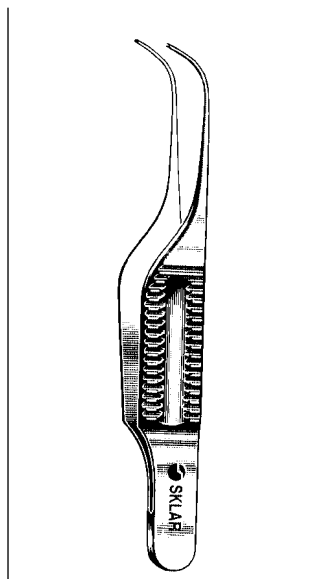
EYE INSTRUMENTS

IRIS FORCEPS



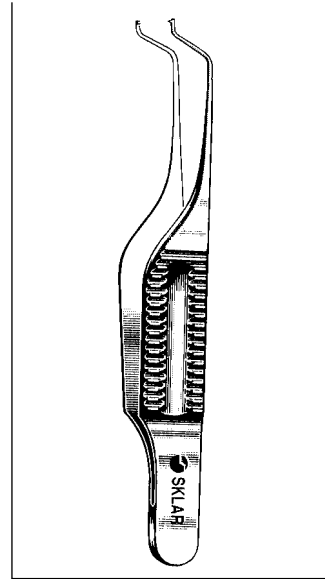
GILL FORCEPS

66-7130 Iris Curved,
length 3" (7.6 cm)



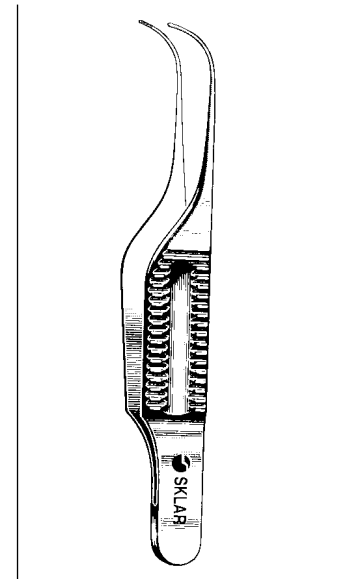
GILL FORCEPS

66-7230 Curved Extra Delicate
length 3" (7.6 cm)



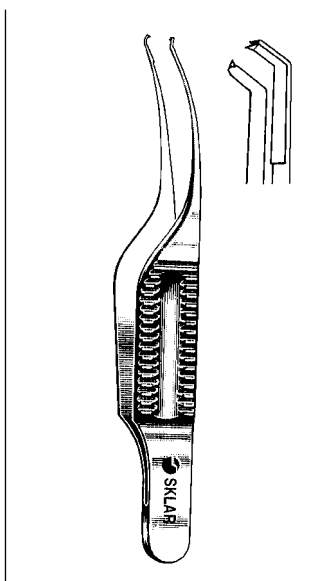
GILL-HESS IRIS FORCEPS

66-7238 2 3/4" with 1 x 2 teeth
forward 0.5 mm
66-7240 2 3/4" with 1 x 2 teeth
down 0.5 mm



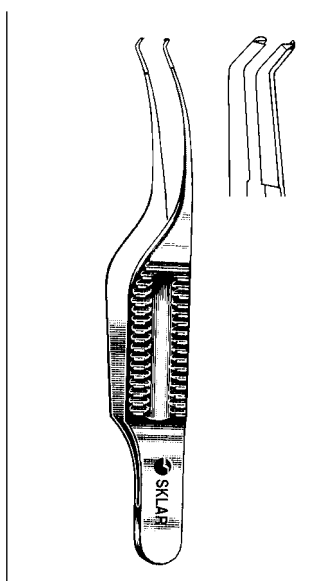
GILL (CHANDLER) IRIS FORCEPS

66-7244 3" Fine cross serrated tips
0.6 mm wide



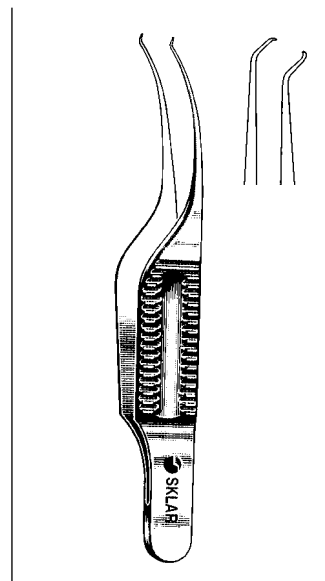
TROUTMAN-BARRAQUER CORNEAL UTILITY FORCEPS

Colibri Type
66-7248 1 x 2 overlapping teeth
0.5 mm



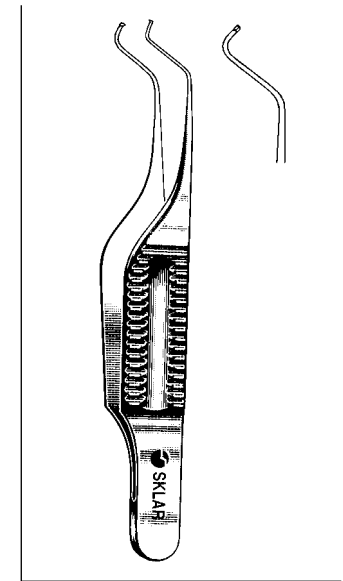
TROUTMAN-BARRAQUER CORNEAL UTILITY FORCEPS

Colibri Type
66-7250 1 x 2 0.5 mm teeth, set at 45°
with tying platform



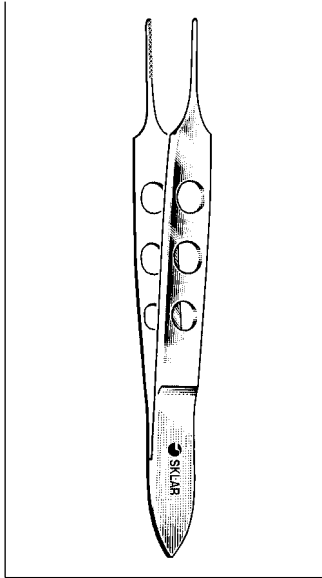
COLIBRI CORNEAL UTILITY FORCEPS

7.5 cm
66-7254 1 x 2 teeth, 0.12 mm
66-7256 1 x 2 teeth, 0.4 mm



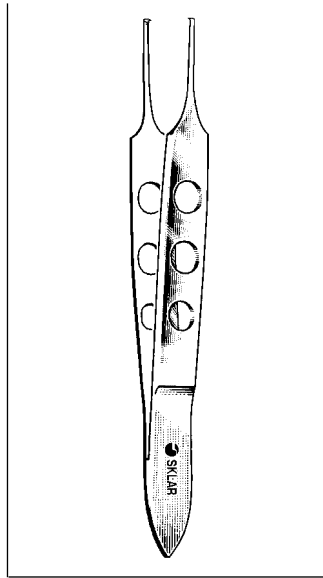
BOTVIN IRIS FORCEPS

66-7258 2 3/4" fine cross serrated tips,
0.5 mm wide
66-7260 2 3/4" with 1 x 2 teeth
0.5 mm wide



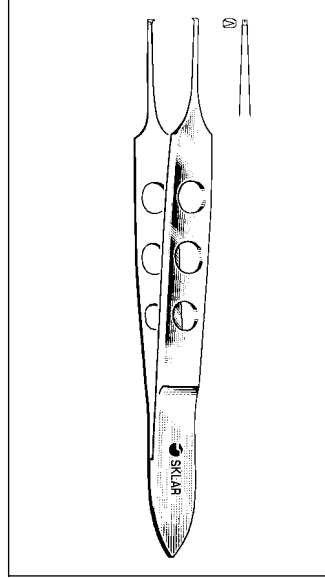
BISHOP-HARMON EYE DRESSING FORCEPS

Serrated, straight tips
66-4032 3 1/4"



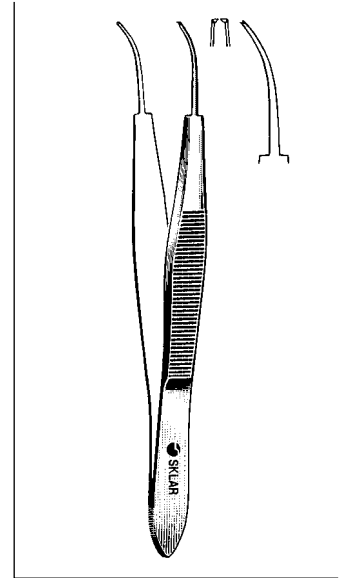
IOWA STATE FIXATION FORCEPS

1 x 2 straight teeth, Delicate tip
66-4232 3 1/4"



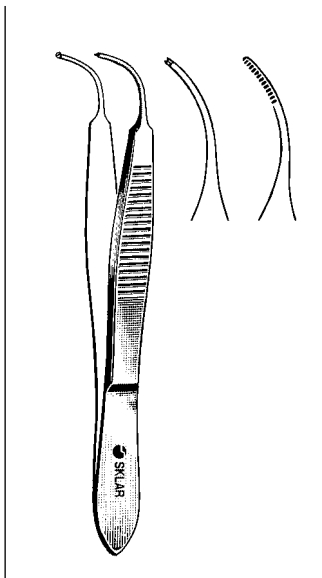
BISHOP-HARMON IRIS FORCEPS

3 1/4" Straight
66-4132 1 x 2 teeth
Standard pattern
66-4133 Extra delicate for
microsurgery



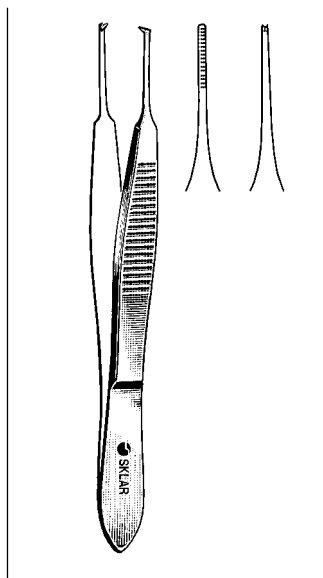
STEVENS IRIS FORCEPS

4 1/4"
66-4950 Straight without catch
66-4951 Curved without catch
66-4952 Straight with catch
66-4953 Curved with catch



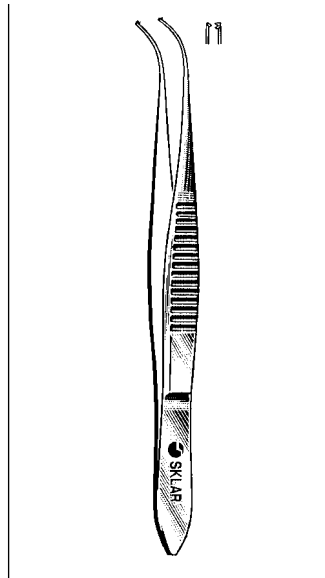
VON GRAEFE IRIS FORCEPS

2 3/4" Curved, Delicate
66-4625 1 x 2 teeth
66-4626 Serrated tips



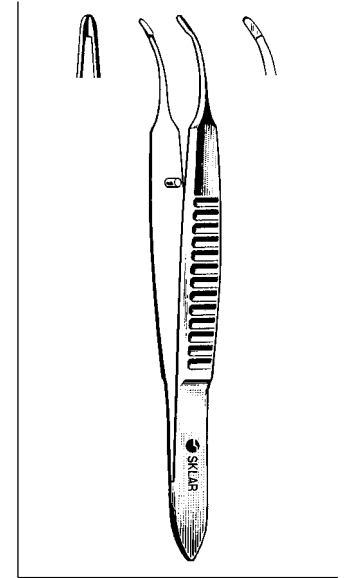
VON GRAEFE IRIS FORCEPS

2 3/4" Straight, Delicate
66-4525 1 x 2 teeth
66-4526 Serrated tips



FORESTER IRIS FORCEPS

3 3/4" Curved tips, 1 x 2 teeth on
outside of curve
66-4530 Standard handle

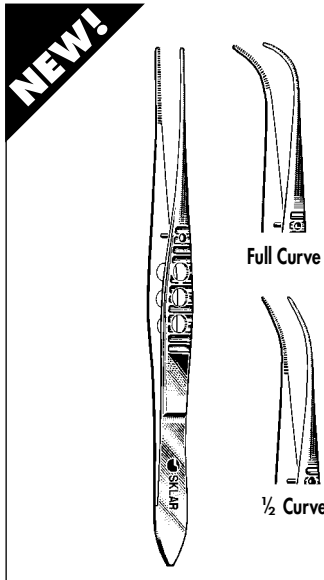


CHANDLER IRIS FORCEPS

66-3927 2 1/4" Curved

EYE INSTRUMENTS

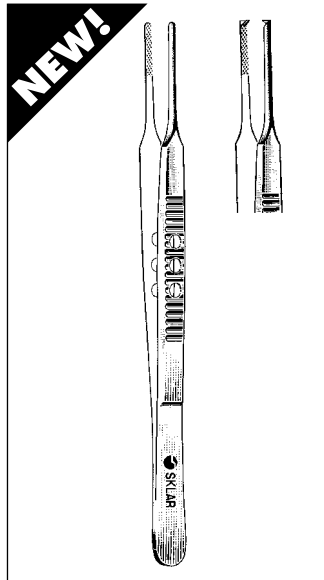
IRIS/TISSUE FORCEPS



SKLAR LITEGRIP™ IRIS FORCEPS

Serrated

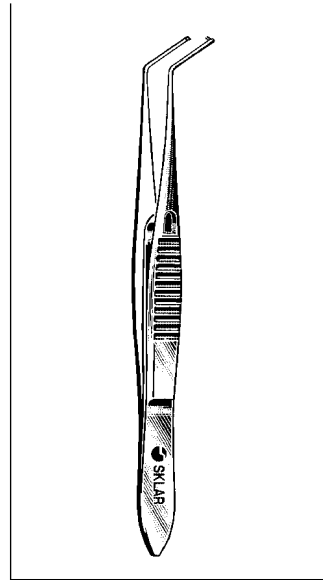
- 66-2742 4" Straight
- 66-2942 4" 1/2 Curved
- 66-3142 4" Full Curve



SKLAR LITEGRIP™ IRIS FORCEPS

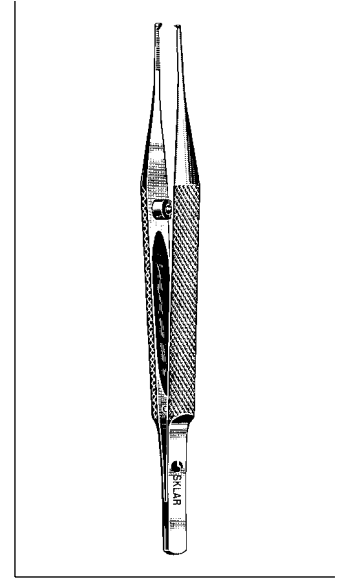
1 x 2 Teeth

- 66-3342 4" Straight
- 66-3542 4" 1/2 Curved
- 66-3742 4" Full Curve



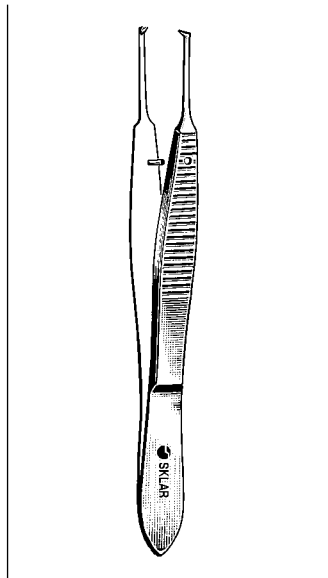
O'CONNOR IRIS FORCEPS

- 66-3350 3 3/4" Angular jaws
0.5 x 9 mm with 1 x 2 teeth



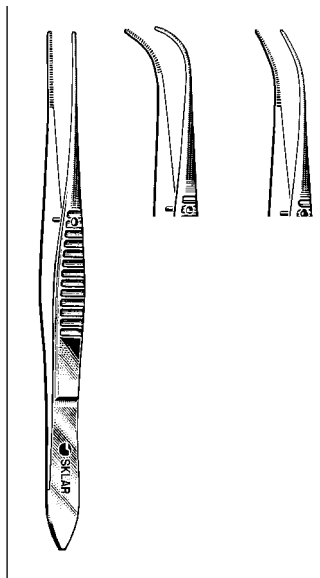
KIRBY IRIS FORCEPS

- 66-2750 4" Straight 1 x 2 teeth
- 66-2755 4" Curved 1 x 2 teeth



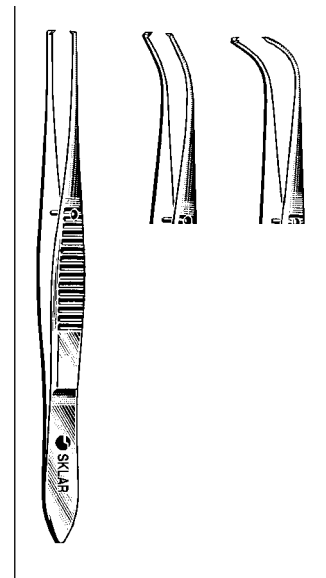
GRAEFE FORCEPS

- 66-4525 2 3/4" Straight 1 x 2 teeth
- 66-4625 2 3/4" Curved 1 x 2 teeth
- 66-4526 2 3/4" Straight Serrated
- 66-4626 2 3/4" Curved Serrated



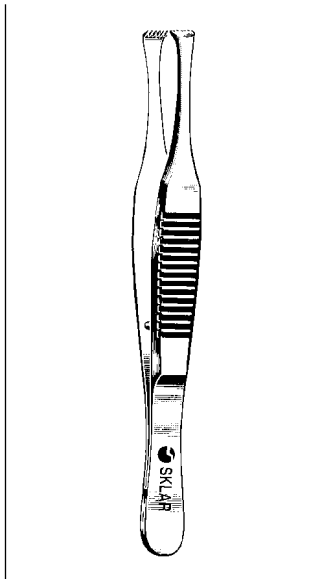
EYE DRESSING FORCEPS

- Serrated
- 66-2740 4" Straight
- 66-2940 4" Half Curve
- 66-3140 4" Full Curve
- Non-Magnetic
- 66-2840 4" Straight



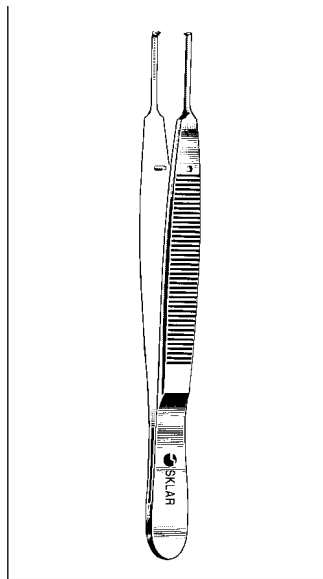
EYE TISSUE FORCEPS

- 1 x 2 Teeth
- 66-3340 4" Straight
- 66-3540 4" Half Curve
- 66-3740 4" Full Curve
- Non-Magnetic
- 66-3240 4" Straight



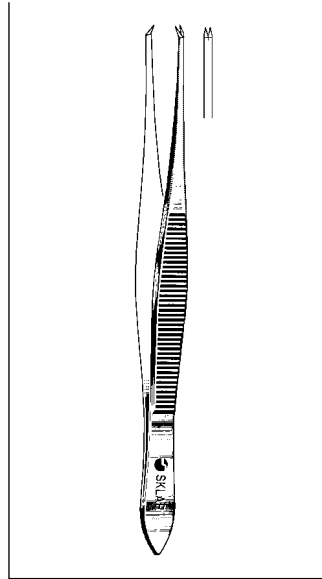
HARMON FORCEPS

66-1930 3" (7.6 cm)



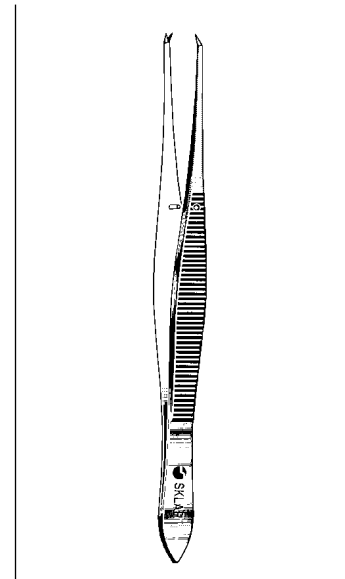
LESTER CONJUNCTIVAL FORCEPS

66-4235 3 3/8" (9.2 cm) 1 x 2 teeth,
non-magnetic



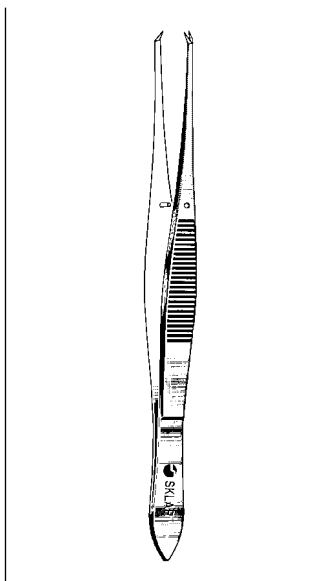
ELSCHMIG FIXATION FORCEPS

4 1/4" Angled Upwards
66-2350 Strong 1 x 2 teeth,
0.9 mm wide



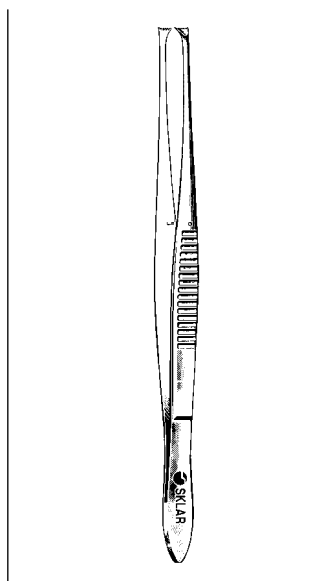
KUHNT FIXATION FORCEPS

1 x 2 Curved Teeth
66-2355 4 1/4"



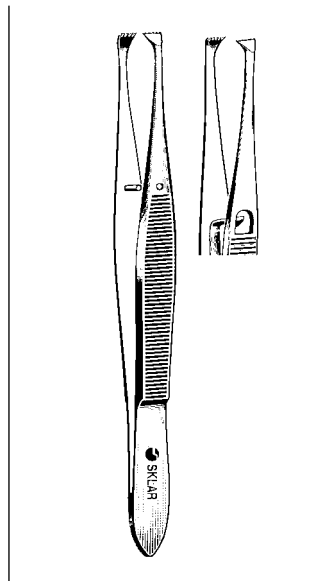
O'BRIEN-ELSCHNIG FORCEPS

66-2440 4" (10.2 cm) Delicate
66-2540 4" (10.2 cm) Without catch



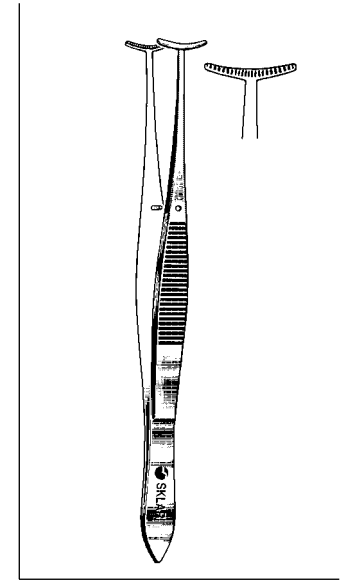
WALDEAU FIXATION FORCEPS

4 1/2" With Fine Teeth
66-2145 Concave jaws 5 mm wide



GRAEFE FIXATION FORCEPS

66-1940 4 1/2" Without Lock
66-2140 4 1/2" With Lock

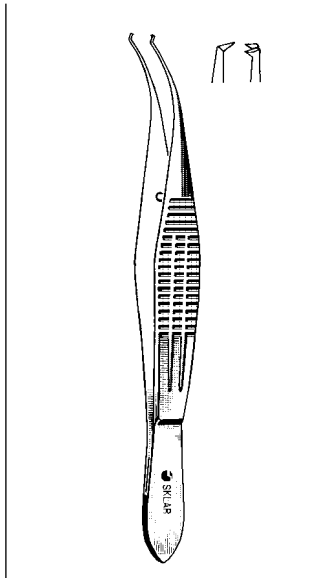


GREEN FIXATION FORCEPS

4"
66-2005 5 mm jaws
66-2009 9 mm jaws
66-2012 12.5 mm jaws

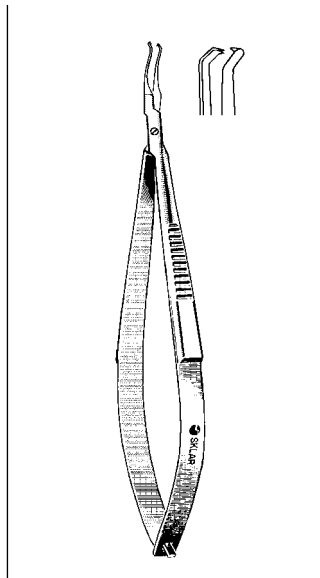
EYE INSTRUMENTS

SUTURING/TYING FORCEPS



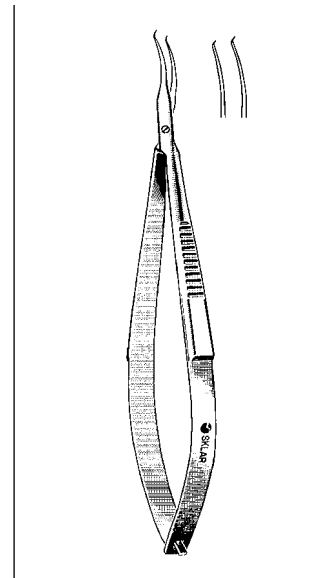
CASTROVIEJO COLIBRI FORCEPS

Wide Handle 4.25" Extra Delicate
66-3450 1 x 2 0.12 mm teeth



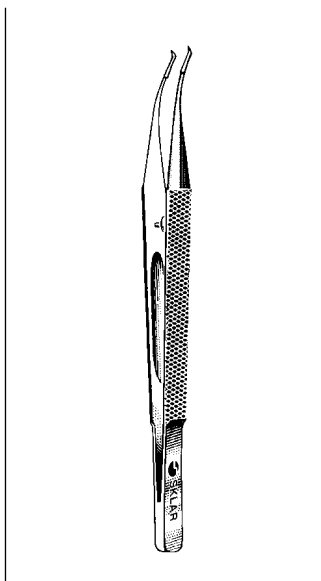
MAUMENEE COLIBRI CORNEAL FORCEPS

1 x 2 teeth 123 mm
66-3455 0.12 mm teeth Set at 90°



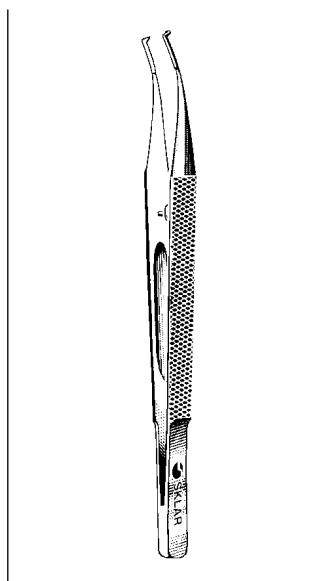
MAUMENEE COLIBRI CORNEAL FORCEPS

Cross action with tying platform set at 45° 3.5"
66-3460 1 x 1 0.1 mm teeth
66-3462 1 x 2 0.12 mm teeth



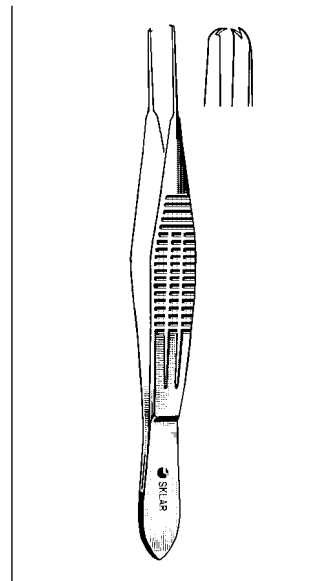
GIRARD CORNEAL UTILITY FORCEPS

4.0" with tying platform, smooth tip, 0.5 mm wide
66-6120



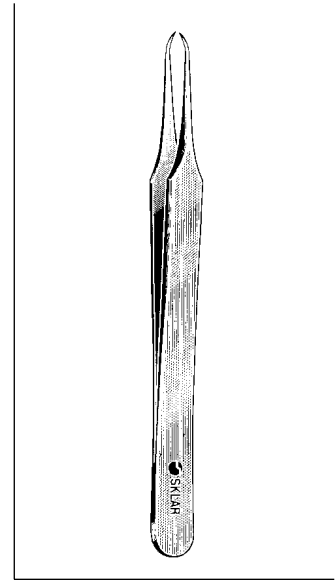
GIRARD CORNEAL SCLERAL FORCEPS

4.1" with tying platform
66-6130 1 x 2 0.12 mm teeth right
66-6131 1 x 2 0.12 mm teeth left
66-6132 1 x 2 0.3 mm teeth right
66-6133 1 x 2 0.3 mm teeth left



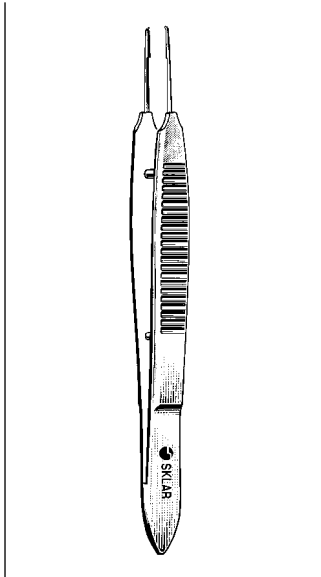
CASTROVIEJO FIXATION FORCEPS

10.9 cm
66-2640 1 x 2 0.3 mm teeth without tying platform
66-2635 1 x 2 0.5 mm teeth without tying platform



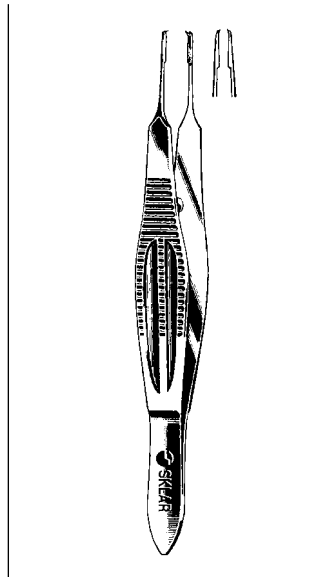
SIMCOE NUCLEUS FORCEPS

11 cm
66-2638 Controlled nucleus delivery



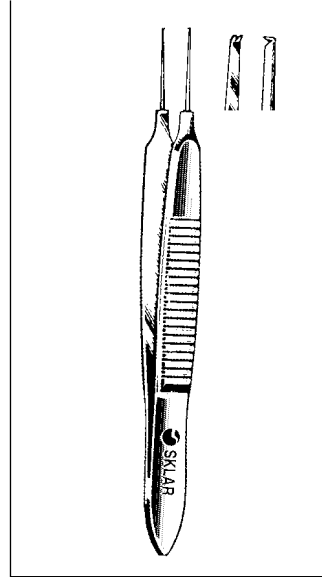
CASTROVIEJO FORCEPS

66-6105 4" .5 mm teeth
66-6109 4" .9 mm teeth



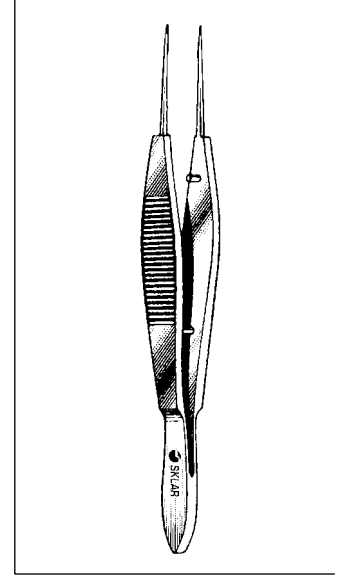
CASTROVIEJO SUTURE FORCEPS

4 1/4" 1 x 2 Platform behind teeth limits depth of penetration Wide handle
66-6115 0.5 mm delicate teeth
66-6118 1.5 mm delicate teeth



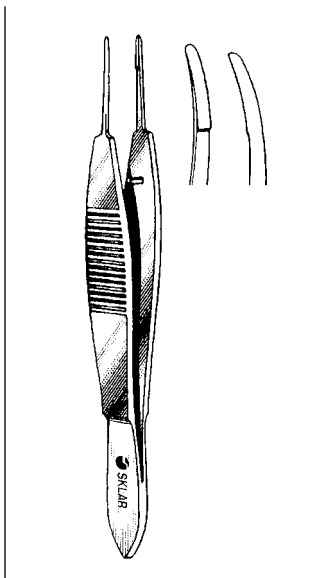
BONN MICRO SUTURING FORCEPS

66-6125 2 1/4" 1 x 2 teeth
0.12 mm with tying platform
66-6126 3 3/4" 1 x 2 teeth
0.12 mm with tying platform



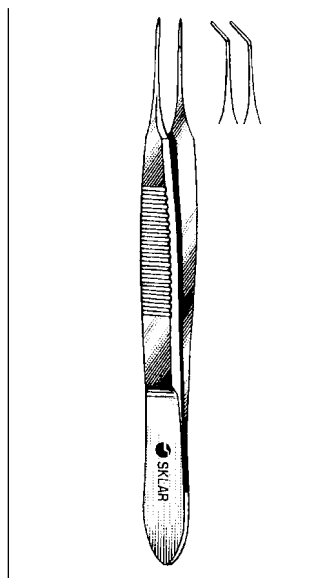
BONN TYING FORCEPS

With tying platform 0.3 mm tip width
66-6160 Straight 4"
66-6162 Curved 4"



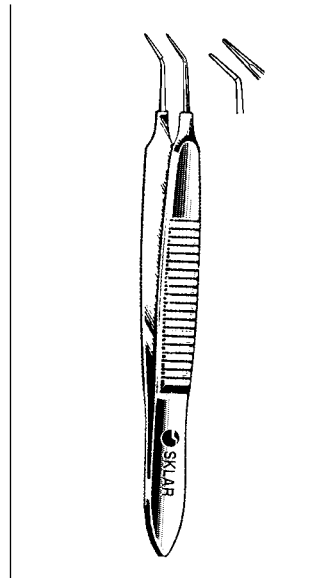
HARMS TYING FORCEPS

With tying platform 0.5 mm tip width 4.0"
66-6140 Straight
66-6142 Curved



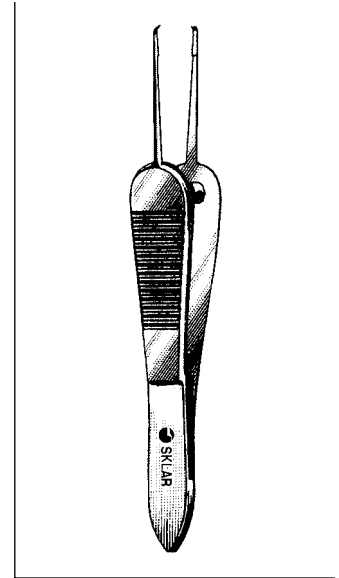
McPHERSON TYING FORCEPS

With tying platform 4.0 mm long 0.3 mm tip width 3.38"
66-6150 Straight
66-6152 Angled



McPHERSON MICRO IRIS SUTURING FORCEPS

Smooth platform 0.3 x 5 mm
66-6164 3 1/2" Straight
66-6166 3 1/2" Curved

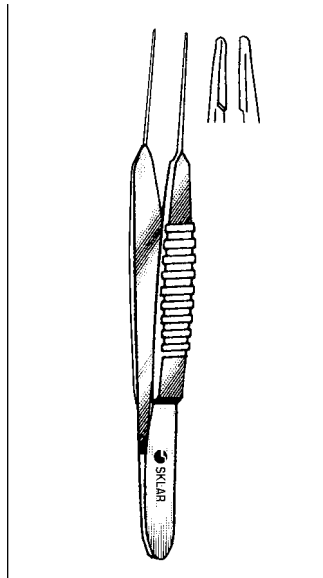


MANHATTAN EYE & EAR SUTURING FORCEPS

3 1/2" with smooth platform
1 x 2 curved teeth overlapping each other 0.7 mm wide
66-6168

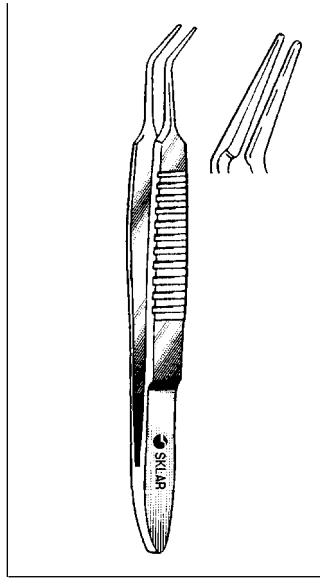
EYE INSTRUMENTS

SUTURING/TYING FORCEPS



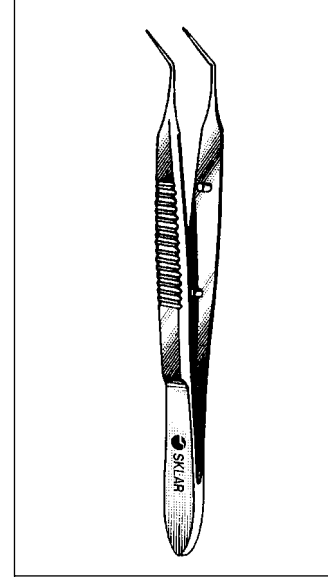
KELMAN-McPHERSON TYING FORCEPS

Straight 86 mm
66-6175 Smooth



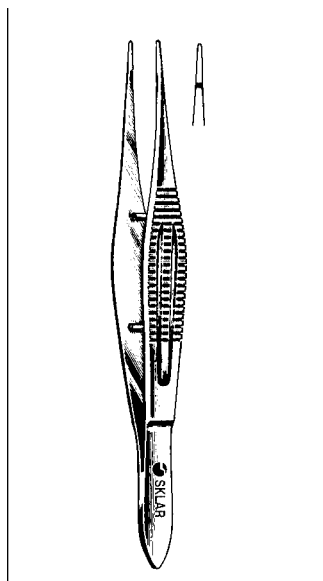
BECHERT-McPHERSON TYING FORCEPS

10 mm tying platform
83 mm
66-6178 Smooth jaws, angled



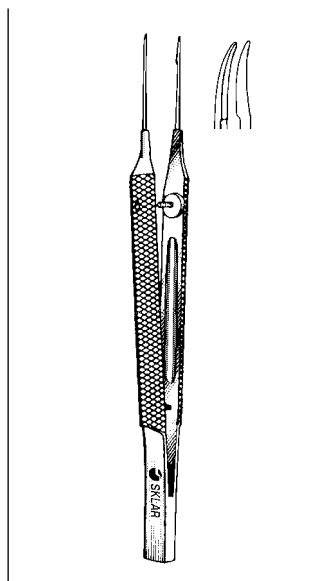
KELMAN-McPHERSON TYING FORCEPS

With tying platform 7.5 mm long
0.3 mm tip width Angled 3.3°
66-6180



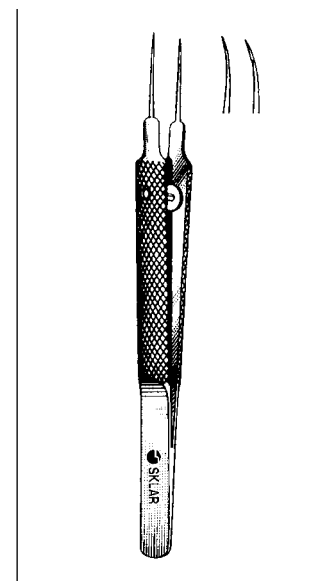
WALTON SUTURE FORCEPS

With tying platform
66-6182 4 1/4" with handle



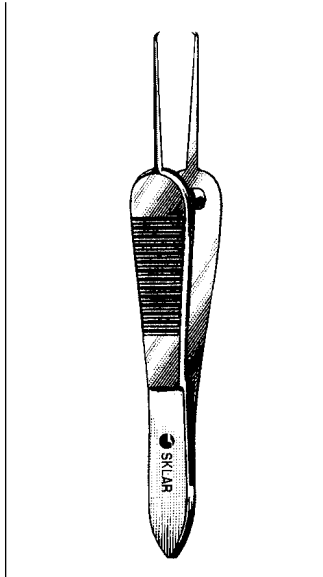
GIRARD TYING FORCEPS

Tying platform
Smooth tips
66-6190 Straight 9.9 cm long
66-6192 Curved 9.9 cm long



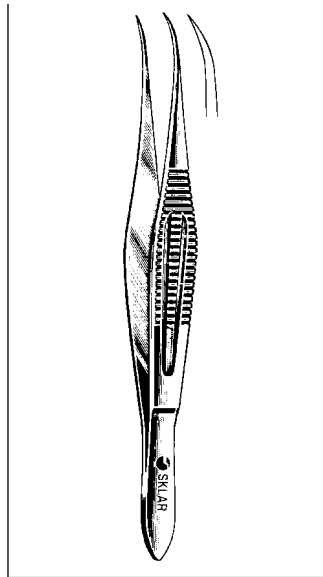
TENNANT TYING FORCEPS

Extra delicate Round handle tying platform 6 mm 0.3 mm tip width
66-6194 Straight 4"
66-6196 Curved 4"



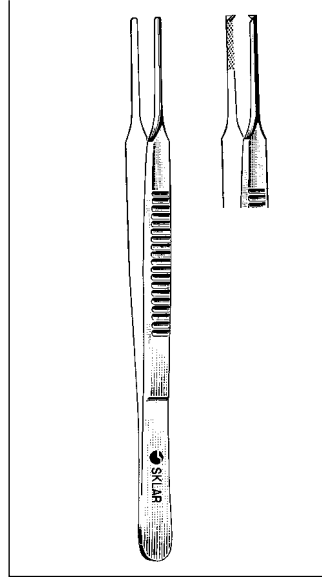
SAUER SUTURING FORCEPS

1 x 2 curved teeth overlapping
each other 0.6 mm wide
66-6200 3½"



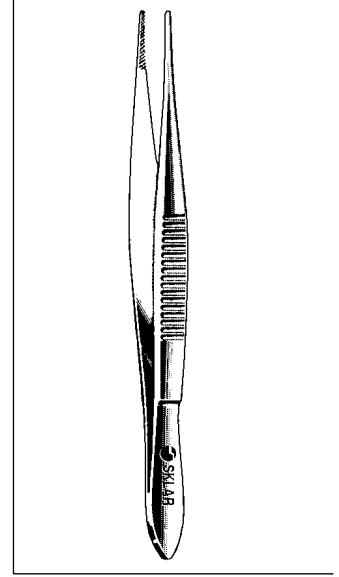
MANHATTAN EYE AND EAR SUTURE FORCEPS

66-6250 4¼" with fine tips



McCULLOUGH UTILITY FORCEPS

66-6110 4" Serrated
66-6112 4" Smooth
66-6114 4" 1 x 2 teeth with serrations



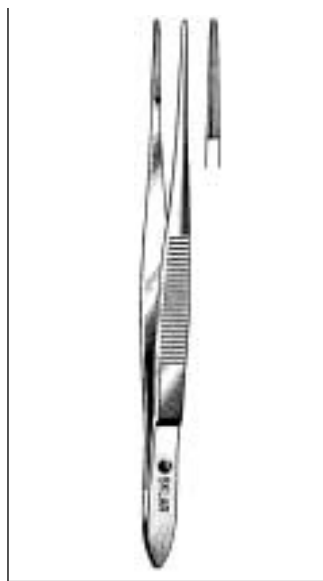
WILLS HOSPITAL UTILITY FORCEPS

66-6268 4" cross serrations on tips



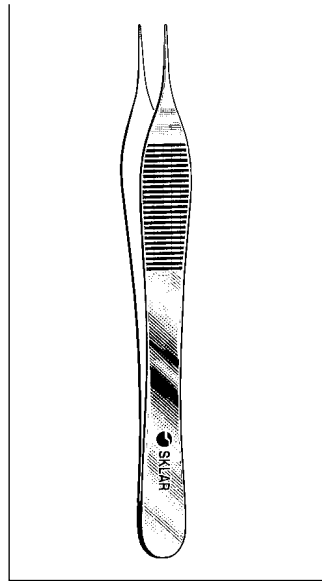
NUGENT UTILITY FORCEPS

66-6240 4¼" Angular smooth tips
66-6242 4¼" Angular serrated tips



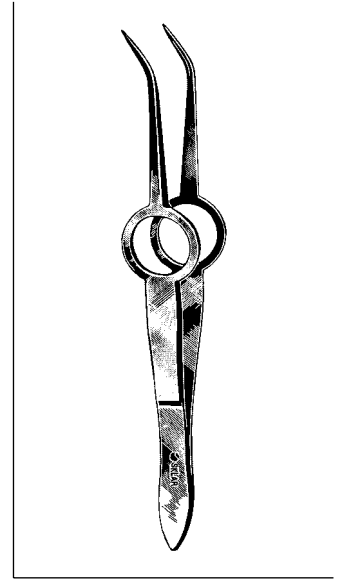
BONACCOLTO UTILITY FORCEPS

Cross serrated at tips for better
pick up Delicate pattern
66-6340 1.2 mm jaws
66-6338 1.7 mm jaws
66-6339 2.4 mm jaws



THORPE CORNEOSCLERAL FORCEPS

66-7347 4¾" (12.1 cm)

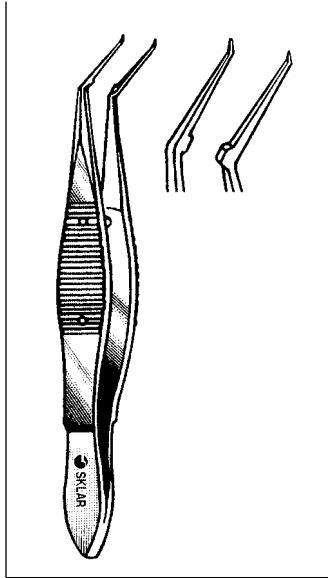


SHAAF FOREIGN BODY FORCEPS

66-6037 3¾" (9.5 cm)

EYE INSTRUMENTS

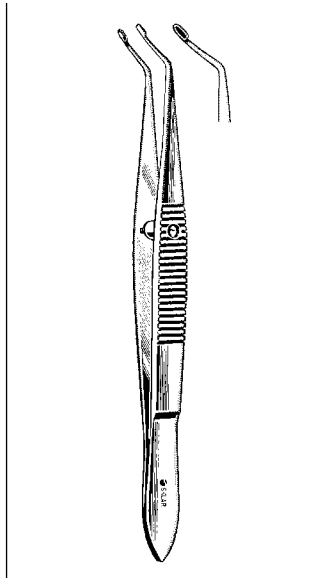
CAPSULE FORCEPS



KRAFF-UTRATA CAPSULORHEXIS FORCEPS

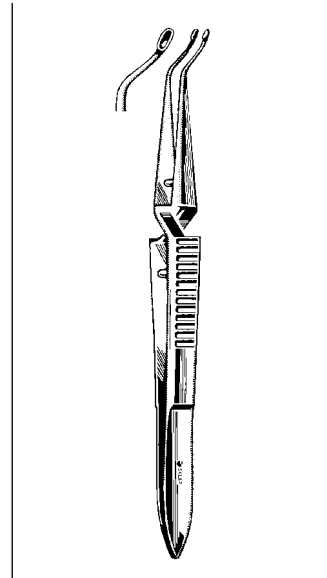
With Iris stops
12 mm long smooth jaws
0.3 mm tip 4"

- 66-5350 Angled jaws, flat handle
- 66-5351 Curved tips, flat handle
- 66-5352 Angled jaws, round handle
- 66-5353 Angled jaws, cystotome tips,
round handle



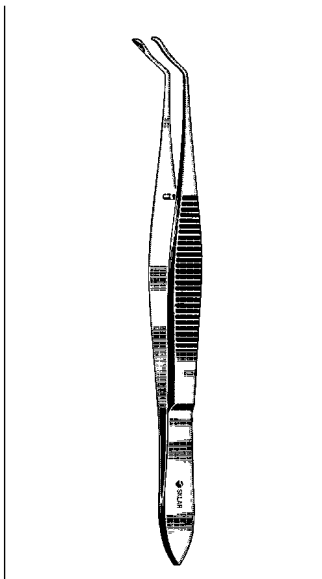
CASTROVIEJO CAPSULE FORCEPS

66-5345 4"



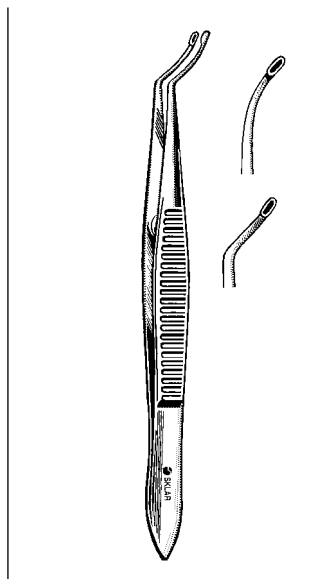
CASTROVIEJO CAPSULE FORCEPS

66-5348 4" Cross action



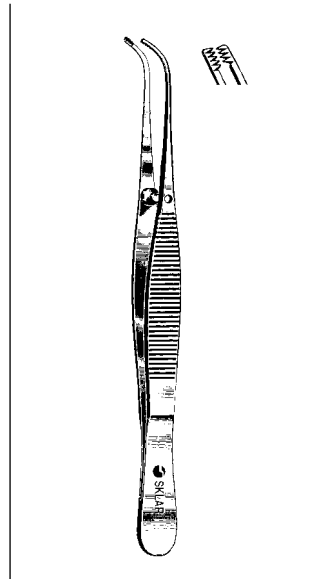
KALT CAPSULE FORCEPS

66-5240 4"



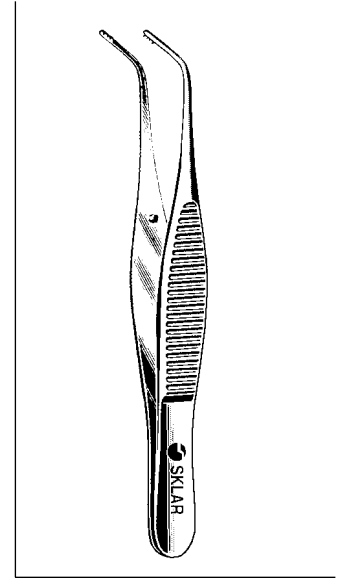
ARRUGA CAPSULE FORCEPS

- 66-5340 4" Standard curve
- 66-5342 4" New curve



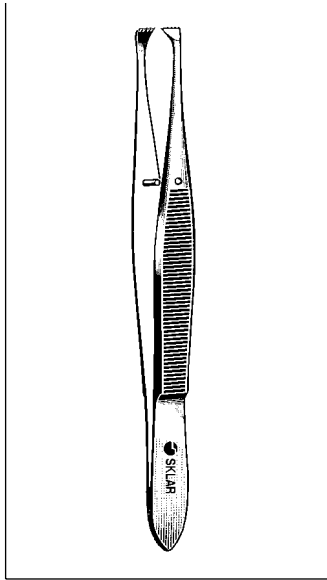
SCHWEIGER EXTRA CAPSULAR FORCEPS

66-5355 3 3/4" 4 x 5 teeth



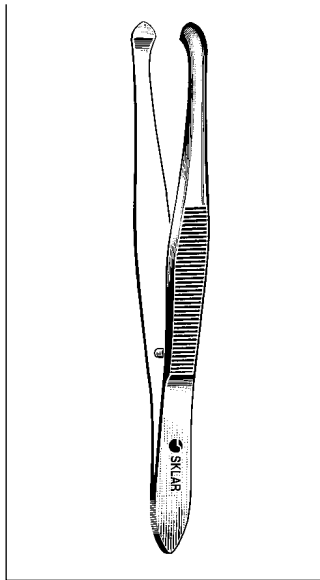
FUCHS EXTRA CAPSULAR FORCEPS

66-5530 2 3/4" 5 x 5 teeth



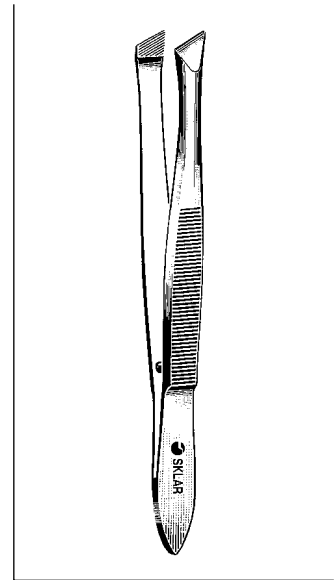
**GRAEFE
FIXATION FORCEPS**

66-1940 4 1/8" Without Lock



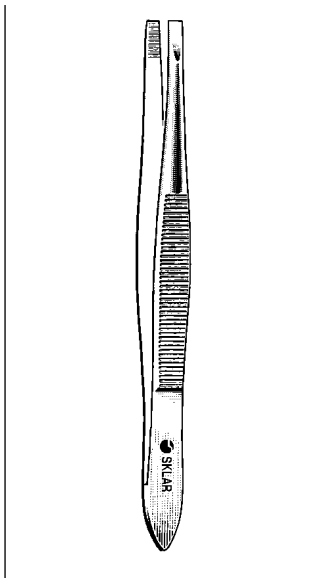
ZIEGLER CILIA FORCEPS

66-1535 3 1/2"



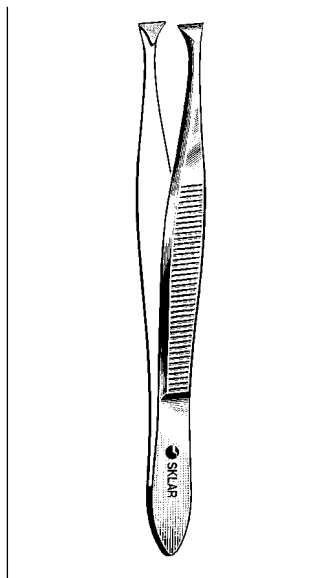
BERGH CILIA FORCEPS

66-1635 3 1/2"



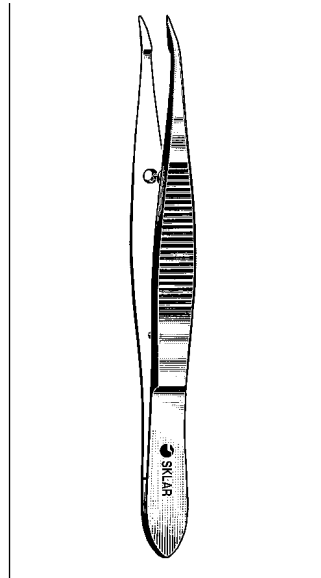
**DOUGLASS
CILIA FORCEPS**

66-1830 3"



**LITTAUER
CILIA FORCEPS**

66-1735 3 1/2"



**BARRAQUER
CILIA FORCEPS**

66-1742 4 1/4"

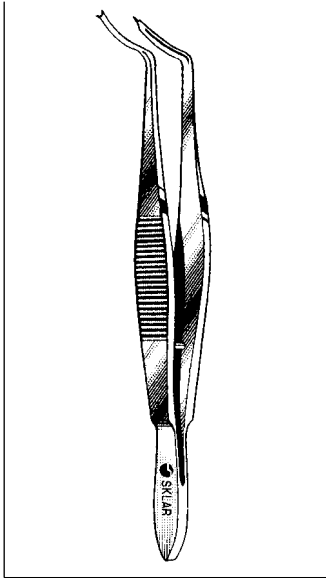


**GRADLE
CILIA FORCEPS**

66-1745 4" Precision ground jaws
1.4 mm wide

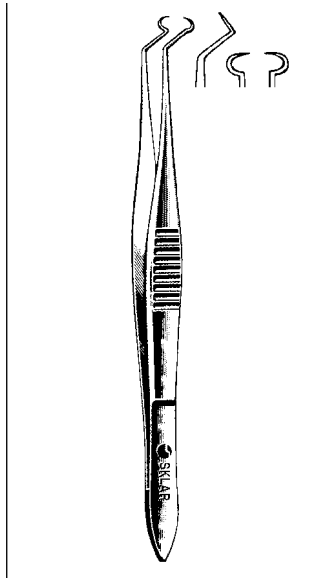
EYE INSTRUMENTS

MUSCLE FORCEPS



**TENNANT-TROUTMAN
SUPERIOR RECTUS FORCEPS**

66-5950 Curved shanks 1 x 2 teeth 4"



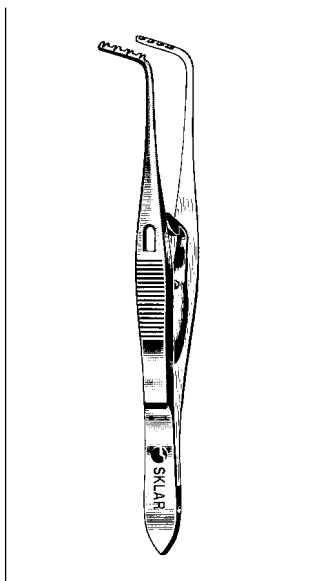
**NUGENT SUPERIOR
RECTUS FORCEPS**

66-6955 3 3/4"



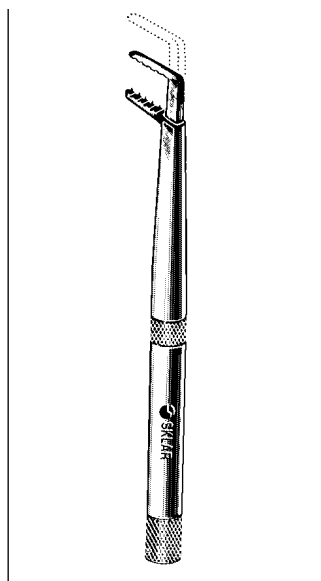
**JAMESON RECESSION
FORCEPS**

66-5960 Left 3 3/4"
66-5962 Right 3 3/4"



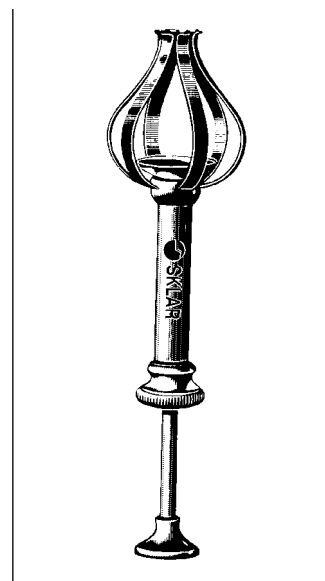
**PRINCE ADVANCEMENT
FORCEPS**

66-5942 4 1/4"



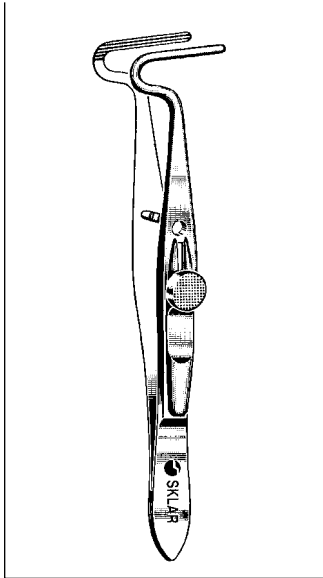
BERENS MUSCLE CLAMP

66-5968 10 x 2 mm jaws 3 1/4"



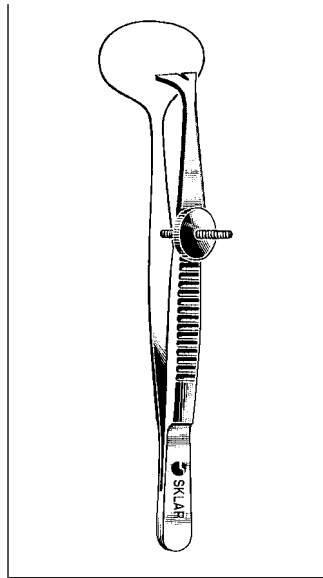
**CARTER SPHERE
INTRODUCER**

65-6930 4 1/4"



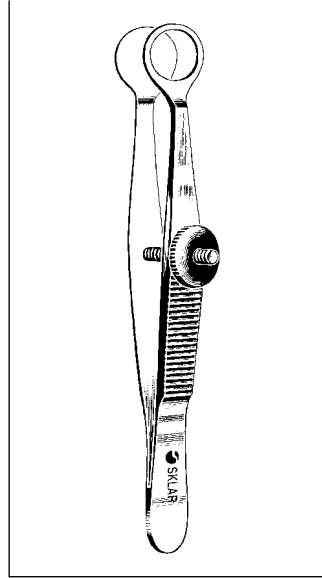
BERKE PTOSIS FORCEPS

66-6342 4½" (10.8 cm)



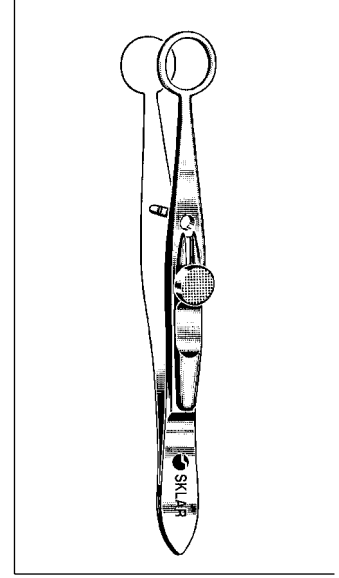
ERHARDT LID FORCEPS

Serrated and Fenestrated
66-1030 3½" 15 mm x 24 mm plate



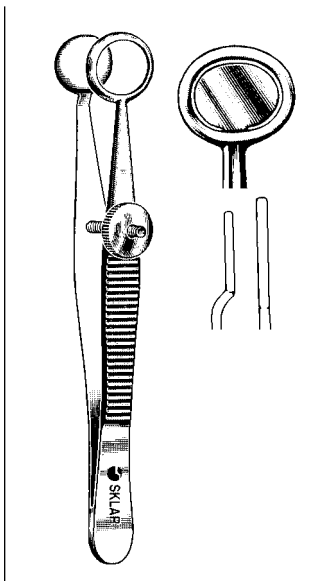
LAMBERT CHALAZION FORCEPS

Fenestrated Smooth jaws
66-1235 3½" 8.0 mm
66-1236 3½" 11.0 mm



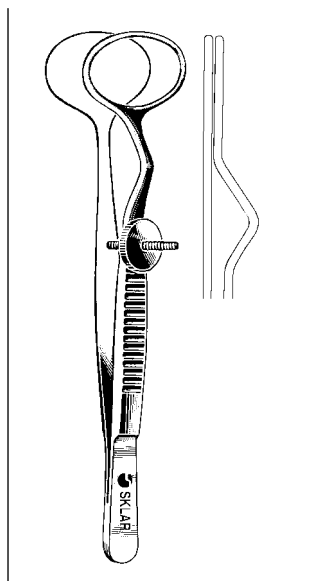
SPENCER CHALAZION FORCEPS

With lock Fenestrated Smooth jaws
66-1240 4" 9.5 mm Jaw



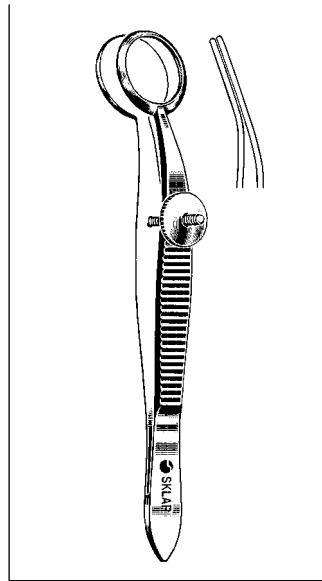
BAIRD CHALAZION FORCEPS

9.6 cm Long
66-1250 8 mm x 12 mm
upper plate



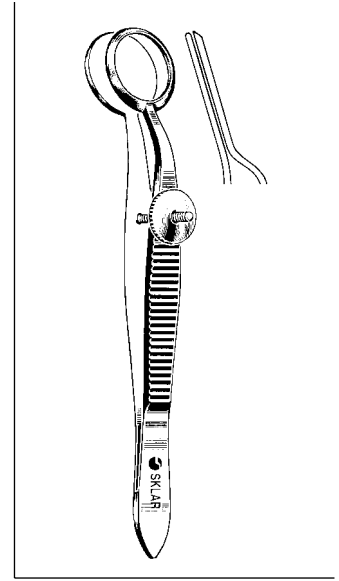
FRANCIS CHALAZION FORCEPS

3¾" Long
66-1255 12 mm x 14 mm
upper plate 3¾"



HUNT CHALAZION FORCEPS

3¾" Long
66-1260 16 mm diameter

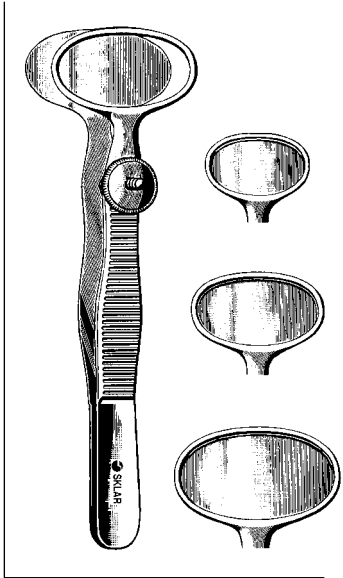


HEATH CHALAZION FORCEPS

Lower shaft curved
Upper shaft offset to prevent
crushing of lid
66-1037 11 mm diameter 3½"
66-1137 16 mm diameter 3½"

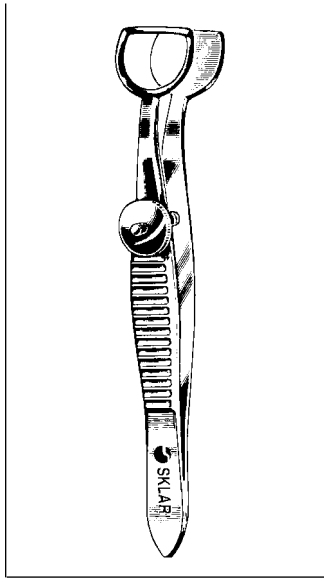
EYE INSTRUMENTS

CHALAZION FORCEPS



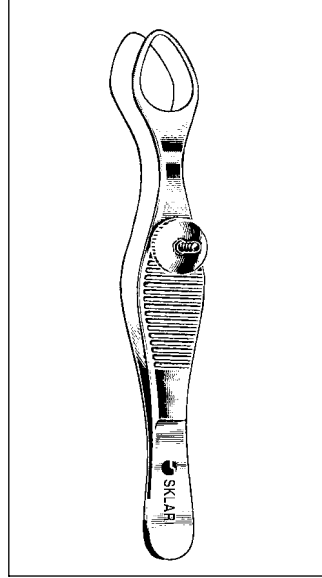
DESMARRES LID RETRACTOR

66-1038 3/4" Small
 66-1036 3/2" Medium
 66-1035 3/2" Large



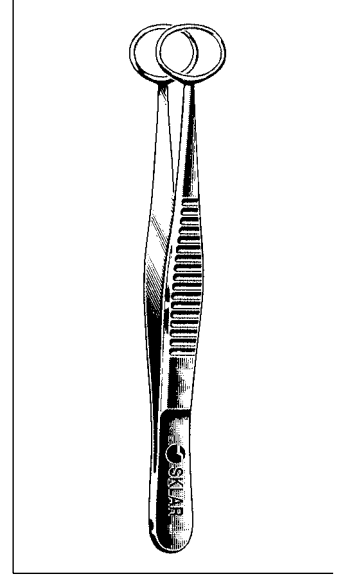
WEIS CHALAZION FORCEPS

Serrated and Fenestrated
 66-1265 4" 9 mm x 12 mm jaw



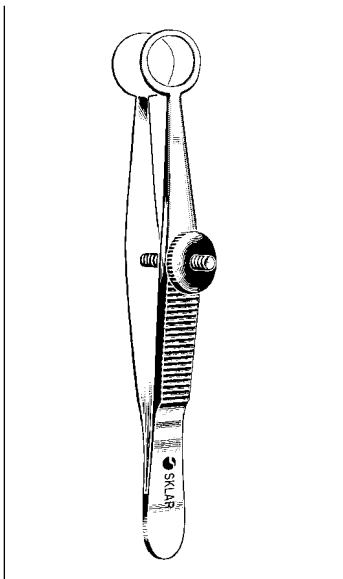
LORDON CHALAZION FORCEPS

Serrated and Fenestrated
 66-1270 3/2" 8 mm x 13 mm jaw



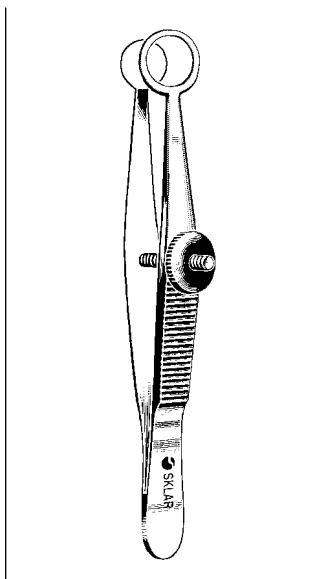
PRINCE TRACHOMA FORCEPS

66-1275 3/2" Rings measure
 8 mm x 10 mm



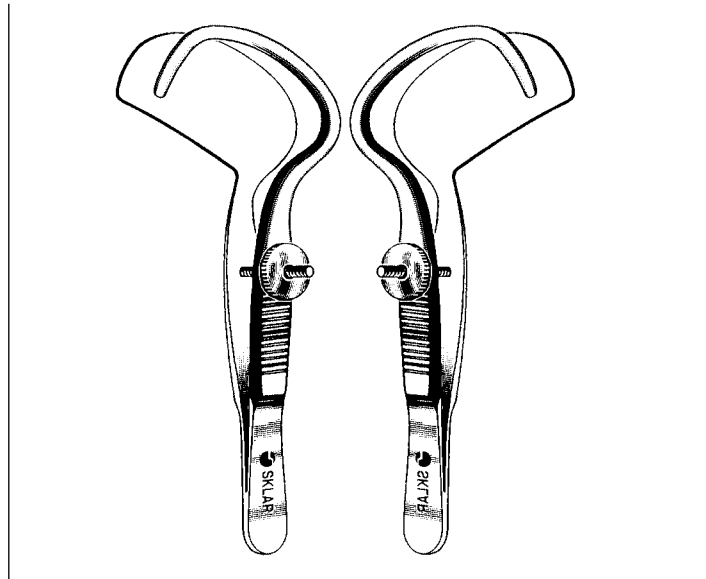
LAMBERT CHALAZION FORCEPS

66-1236 3/2" 11 mm diameter



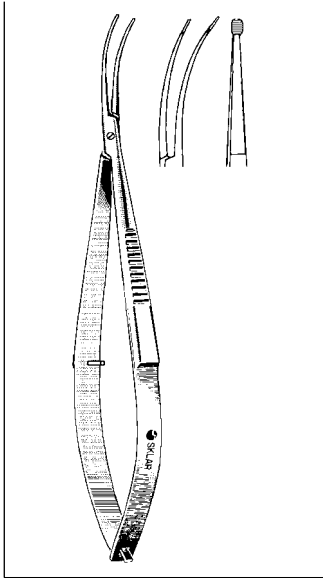
AYER CHALAZION FORCEPS

66-1435 3/2" 9 mm inside diameter



SNELLEN ENTROPIUM FORCEPS

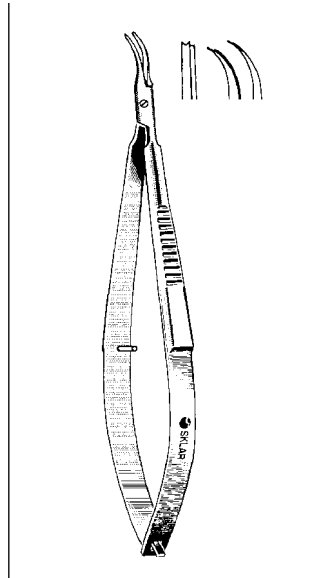
3/2" 35 mm
 66-1280 Left
 66-1282 Right



SHEPARD I - IOL INSERTING FORCEPS

Serrated platform (2 mm x 8 mm)
4.64"

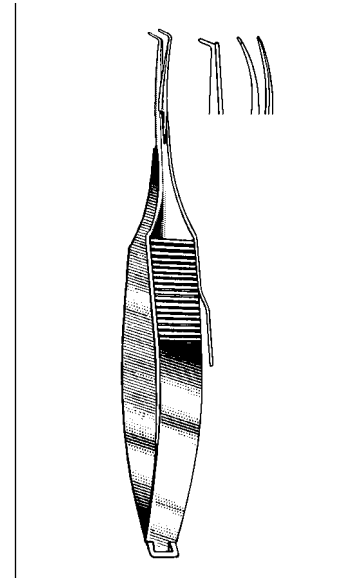
- 66-7660 Without lock-without irrigation
- 66-7662 With lock-without irrigation
- 66-7664 Without lock-with irrigation
- 66-7666 With lock-with irrigation



SHEPARD II - IOL INSERTING FORCEPS

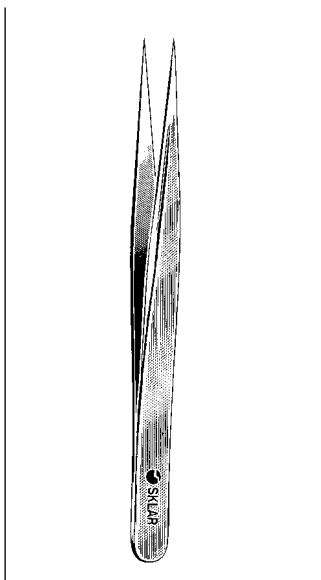
Notched tip (.5 mm x .4 mm) 4.4"

- 66-7653 Without lock-without irrigation
- 66-7654 With lock-without irrigation
- 66-7655 Without lock-with irrigation
- 66-7656 With lock-with irrigation



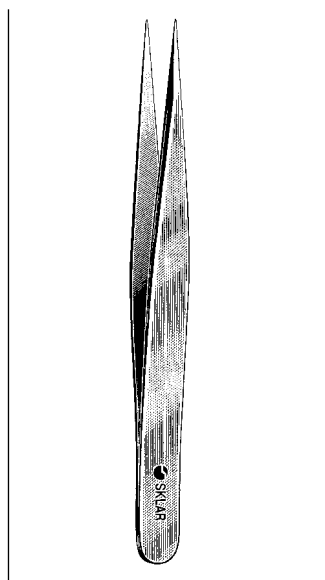
CLAYMAN - IOL INSERTING FORCEPS

- 66-7657 Without irrigation
- 66-7658 With irrigation



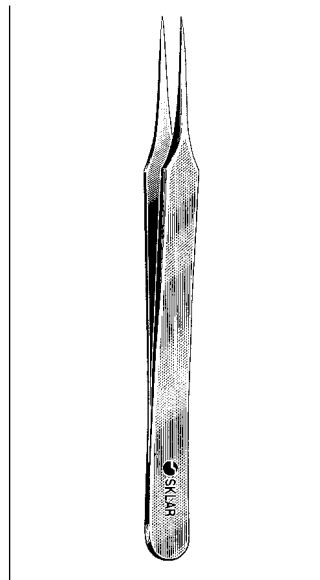
JEWELERS STYLE FORCEPS

66-7447 #3 Straight



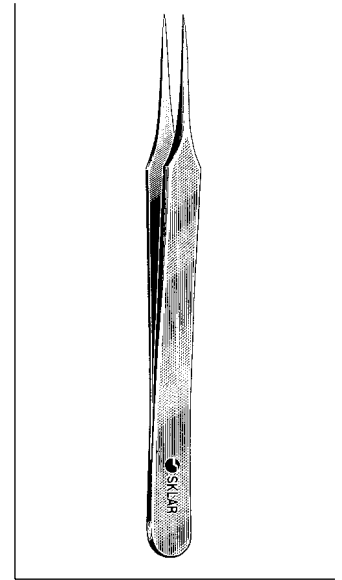
JEWELERS STYLE FORCEPS

66-7442 #3C Straight Delicate



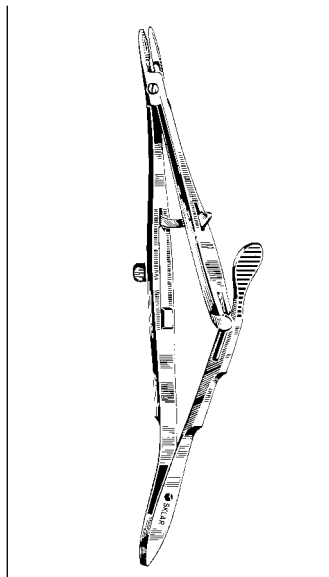
JEWELERS STYLE FORCEPS

66-7542 #4 Straight Delicate



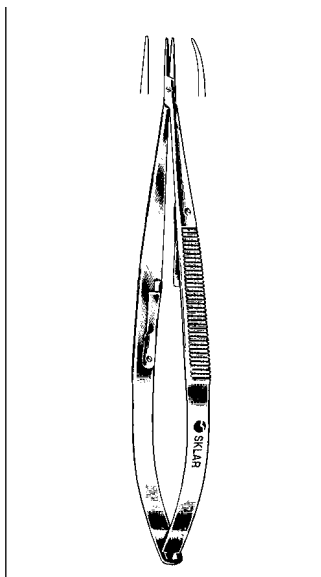
JEWELERS STYLE FORCEPS

66-7642 #5 Straight



CASTROVIEJO-KALT NEEDLE HOLDER

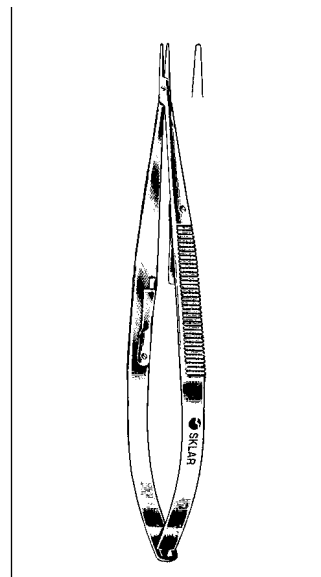
With Suture Cutter
65-6255 5½"



CASTROVIEJO NEEDLE HOLDERS

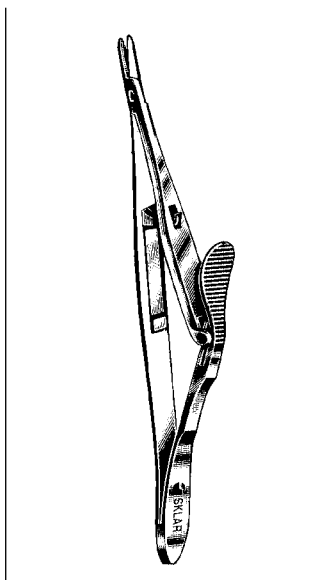
Standard handle, Extra Delicate, Smooth Jaws
to hold 7-0 Sutures (especially milled handle to
improve traction)

- 65-6350 5¼" Straight jaw without catch
- 65-6352 5¼" Straight jaw with catch
- 65-6354 5¼" Curved jaw with catch



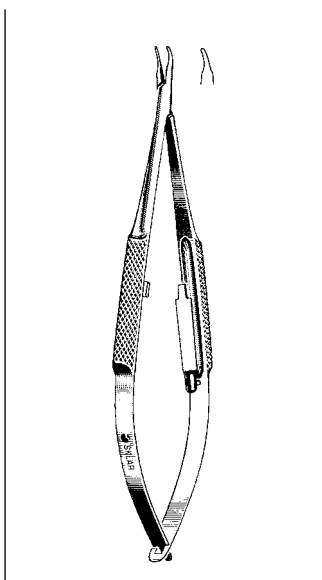
CASTROVIEJO NEEDLE HOLDER

With Catch
65-6357 5½" Straight
65-6358 5½" Curved



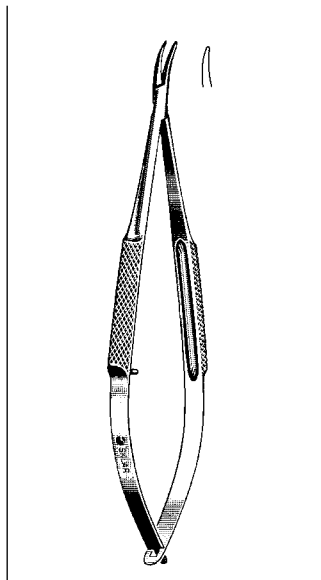
KALT NEEDLE HOLDER

Standard 13.5 cm
65-6055 Straight



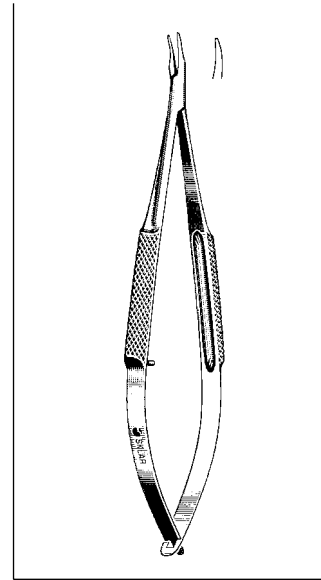
BARRAQUER NEEDLE HOLDERS

Round grip spring handle, with
inside catch
65-6446 5¼" Delicate Curved Jaw
65-6448 5¼" Smooth Curved Jaw



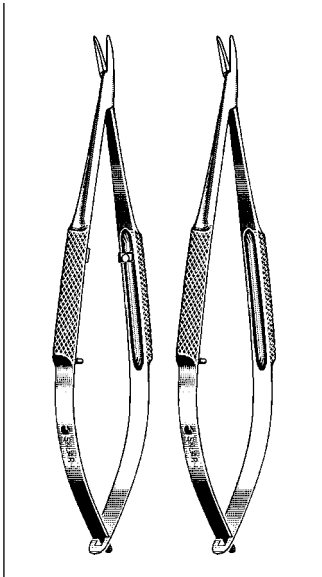
BARRAQUER NEEDLE HOLDER

Delicate curved jaw, round grip
spring handle, without catch
65-6452 5¼"



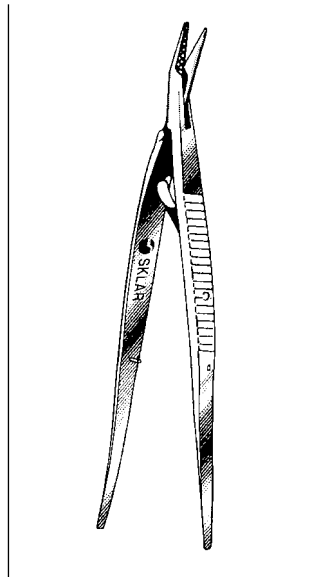
TROUTMAN NEEDLE HOLDER

Extra delicate curved jaw, round
grip spring handle
65-6460 4¾" with inside catch
65-6462 4¾" without inside catch



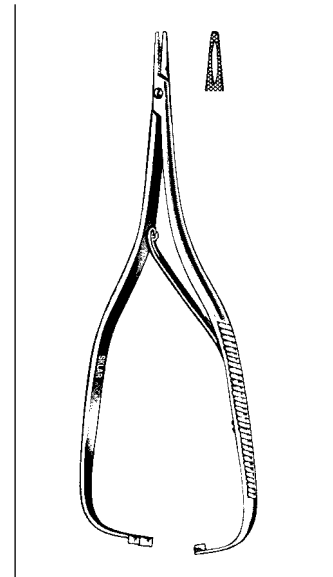
COHAN NEEDLE HOLDER

Mini-micro 7 mm jaws 100 mm
 65-6470 Curved without lock
 65-6475 Curved with lock



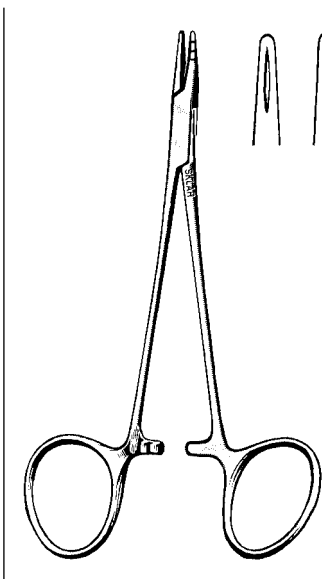
GREENE NEEDLE HOLDER AND FORCEP

10.5 cm
 65-6480 Angled jaw



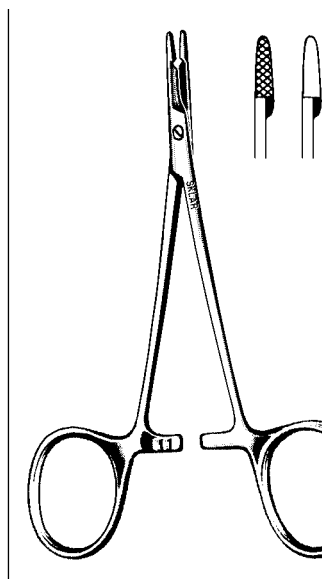
BOYNTON NEEDLE HOLDER

47-2150 5" Delicate



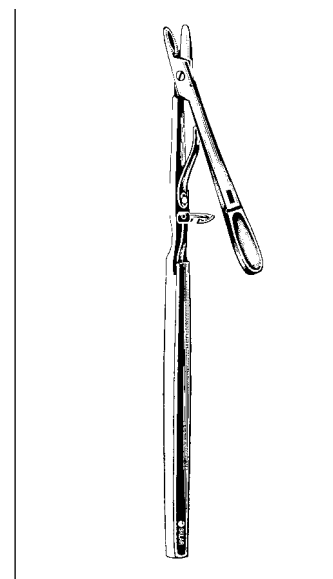
NEIVERT NEEDLE HOLDER

20-1760 5" One offset ring



OLSEN-HEGAR COMBINED NEEDLE HOLDERS AND SCISSORS

Delicate
 20-2747 4 3/4" Serrated jaws
 20-2748 4 3/4" Smooth jaws



STEVENS NEEDLE HOLDER

65-6265 6 1/2"



Sklar-Diamond™ Blades For The Ultimate In Surgical Control

Meeting the demands of ophthalmic surgery requires blade qualities that stainless steel simply doesn't have. Sklar-Diamond™ ultra thin blades offer the ability to meet the specific demands of precision surgery, with the highest level of comfort and precision.

Sklar's diamond blades minimize corrosion, slippage and backlash. These blades actually reduce trauma, promote faster healing, and produce the thinnest scars possible.

Sklar diamond blade edges are gem quality; free of structural defects, flaws and internal stresses; and guaranteed to be sharp at 100x magnification. The blades are sharp on both sides, and all facets are optically smooth.

Ultra-Thin diamond blades are available in a wide variety of blade types and shapes, and come securely mounted in a blade assembly with compression bushings.

Precision Handcrafted Quality Blades

Sklar offers the finest quality blades. The diamonds are selected by hand, cleaved to a rough configuration, and hand polished to give the surgeon a precise, clean and consistent edge. Sklar's diamonds are free of inclusions and internal defects. The included angles of the cutting edges are reduced for greater sharpness. Surfaces on the cutting edge facets are optically flat.

Sklar-Diamond™ Blades are available in the following configurations.

<p>45° 1.0 0.17 Straight 45°</p>	<p>30° 1.0 0.17 Straight 30°</p>	<p>3F 1.0 0.17 Tri-facet</p>	<p>60° 1.4 0.17 Lance</p>	<p>90° 3.0/3.2/2.8 22/23/43 0.17 Phaco spear</p>																	
<p>1.0 0.17 Curved</p>	<p>90° 1.4 0.17 Spear</p>	<p>30° 1.0 0.17 Straight 30° single edge</p>	<p>60° 1.4 0.17 Lance single edge</p>	<p>2.0 0.27 Dupuytren's blade</p>																	
<p>90° 2.5/2.8/3.0/3.2/3.5 98/72/73/74/93 0.17 Clear cornea</p>	<p>2.0 0.2 Tunnel blade</p>	<h4 style="text-align: center;">Specifications</h4> <table border="1"> <tbody> <tr> <td colspan="2">Tolerances</td> <td rowspan="5">Cutting Edge: Sharp at 100x magnification Chip out < 3µm Tip Facet: Not longer than 10µm Blade dimensions are in mm.</td> </tr> <tr> <td>T = 0.17 mm</td> <td>T ± 0.03</td> </tr> <tr> <td>W = 1.00 mm</td> <td>W ± 0.05</td> </tr> <tr> <td>L = 6.00 mm</td> <td>L ± 0.5</td> </tr> <tr> <td></td> <td>Angle ± 3°</td> </tr> <tr> <td colspan="2">Dupuytren's Blade:</td> <td></td> </tr> <tr> <td>T = 0.27 mm</td> <td>L = 6 mm</td> <td></td> </tr> </tbody> </table>			Tolerances		Cutting Edge: Sharp at 100x magnification Chip out < 3µm Tip Facet: Not longer than 10µm Blade dimensions are in mm.	T = 0.17 mm	T ± 0.03	W = 1.00 mm	W ± 0.05	L = 6.00 mm	L ± 0.5		Angle ± 3°	Dupuytren's Blade:			T = 0.27 mm	L = 6 mm	
Tolerances		Cutting Edge: Sharp at 100x magnification Chip out < 3µm Tip Facet: Not longer than 10µm Blade dimensions are in mm.																			
T = 0.17 mm	T ± 0.03																				
W = 1.00 mm	W ± 0.05																				
L = 6.00 mm	L ± 0.5																				
	Angle ± 3°																				
Dupuytren's Blade:																					
T = 0.27 mm	L = 6 mm																				

Sklar-Diamond™ Knives

The finest gem-quality diamonds, a proprietary blade-making process and superior craftsmanship all combine to make the best diamond knife available.

Select the correct blade geometry, then choose the handle that best fits your needs. The result is a finely tuned surgical instrument, custom made to your specifications.

The diamond blade locks securely into its working position. When finished, the blade retracts fully into the handle to protect your investment.

All knives and handles can be sterilized by all conventional methods and with care in handling, your Sklar-Diamond™ knife will deliver many years of exemplary service.

Other configurations are available – Call For Information



SKLAR-DIAMOND™ TITANIUM STEP KNIVES

Depth at .2, .3, .4, .7, 1.0, 1.5, 2.5 mm

66-8000	Straight 45°	66-8006	Straight 30°	66-8012	Tri Facet	66-8018	Lance
66-8002	Phaco Spear	66-8008	Curved	66-8014	Spear	66-8020	Straight
66-8004	Lance Single Edge	66-8010	Dupuytren's Blade	66-8016	Clear Cornea	66-8022	Tunnel Blade



SKLAR-DIAMOND™ TITANIUM PHACO KNIVES

Bayonet Handle Angled

66-8100	Straight 45°	66-8106	Straight 30°	66-8112	Tri Facet	66-8118	Lance
66-8102	Phaco Spear	66-8108	Curved	66-8114	Spear	66-8120	Straight
66-8104	Lance Single Edge	66-8110	Dupuytren's Blade	66-8116	Clear Cornea	66-8122	Tunnel Blade



Sklar-Diamond™ Micrometer Knives

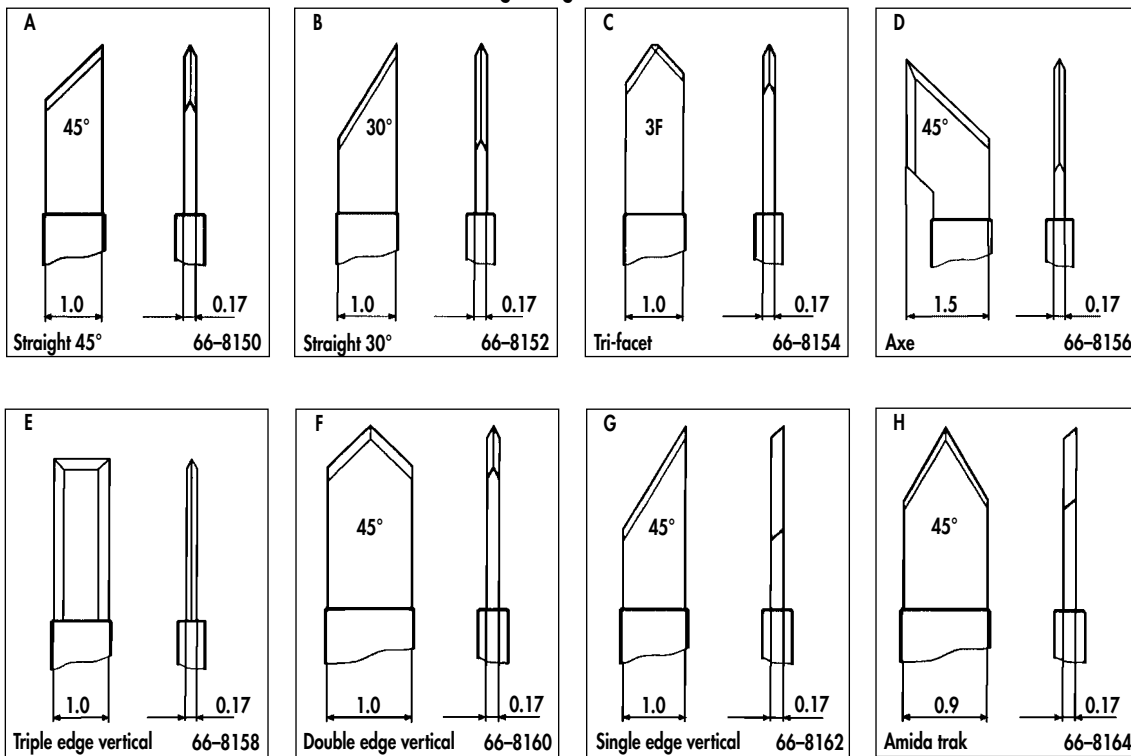
For R.K./A.K. Surgery – The Ultimate in Precision

Sklar's precision micrometer knives are available with Russian, American and Universal footplates with blade configurations shown below. This Sklar design allows the surgeon to easily view the cutting edge from the front, rear and sides when the knife is held in a vertical position.

The precision micrometer handle is calibrated in 50 micron increments around the thimble with a thread advance of 500 microns per 360° revolution, allowing precise adjustments to 10 microns. Titanium handles are manufactured on precision computer-controlled equipment to insure consistency in quality and balance.

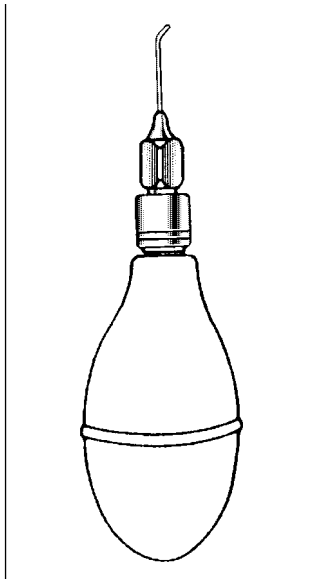


Sklar-Diamond™ Blades are available in the following configurations.



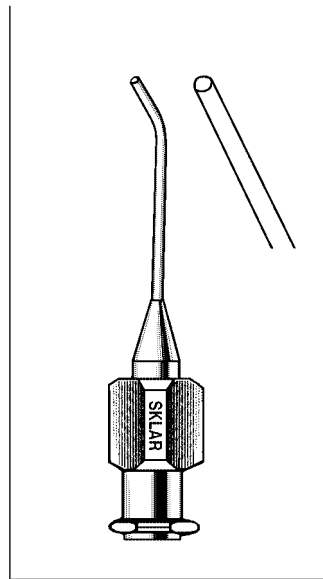
Specifications

Tolerances		Cutting Edge: Sharp at 100x magnification Chip out < 3µm
T = 0.17 mm	T ± 0.03	
W = 1.00 mm	W ± 0.05	Tip Facet: Not longer than 10µm
L = 6.00 mm	L ± 0.5	Blade dimensions are in mm.
	Angle ± 3°	
Special Blade Sizes:		
T = 0.10 mm	No. 11A	No. 12B
W = 1.00 mm	No. 13C	No. 27F
L = 6.00 mm	No. 28G	



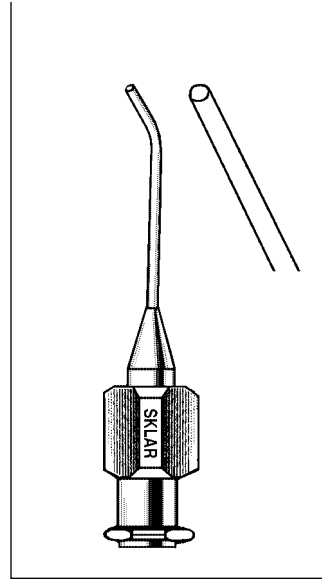
BISHOP-HARMON ANTERIOR CHAMBER CANNULA

- 66-6810 Flattened 19 Gauge Angled
7 mm tip complete with bulb
and adapter
- 66-6811 Bishop-Harmon cannula only
- 66-6812 Adaptor for irrigator
- 66-6813 Silicone bulb only



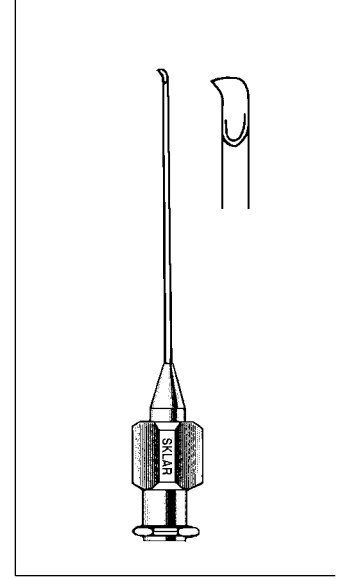
AIR INJECTION CANNULA

66-6900 27 Gauge



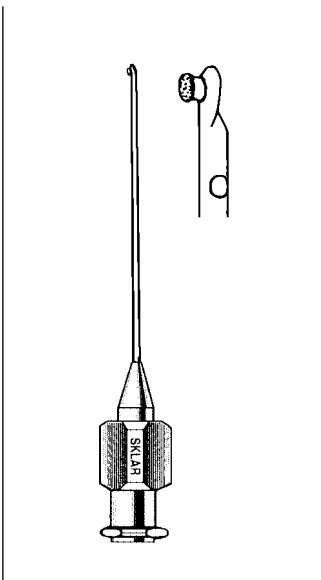
AIR INJECTION CANNULA

66-6902 30 Gauge



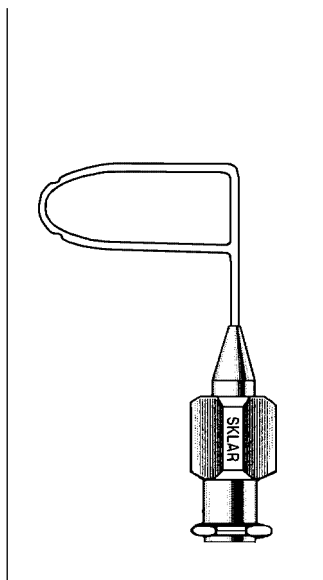
KELMAN AIR CYSTOTOME

- 66-6910 22 Gauge Blunt
- 66-6912 22 Gauge Sharp
- 66-6914 22 Gauge Sharp (Sheets
short model) 13 mm long
- 66-6916 22 Gauge Sharp (Kelman)
Double Blades



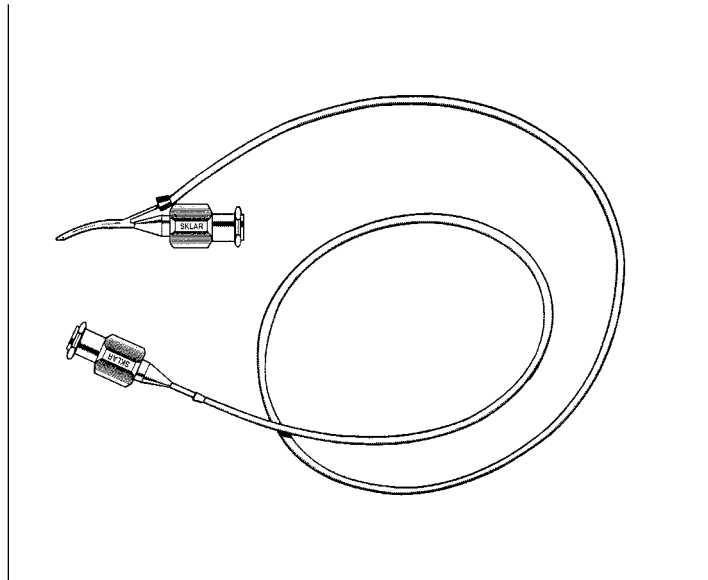
GRAETHER COLLAR BUTTON MICRO-IRIS RETRACTOR

- Roughed Posterior Surface
- 66-6920 23 Gauge Straight 25 mm
- 66-6922 23 Gauge Angled 45°
25 mm



SIMCOE NUCLEUS DELIVERY CANNULA

- Thin Wall
- 66-6925 25 Gauge Two ports Loop
13 mm long 4 mm Wide
Serrations on lens loop, right



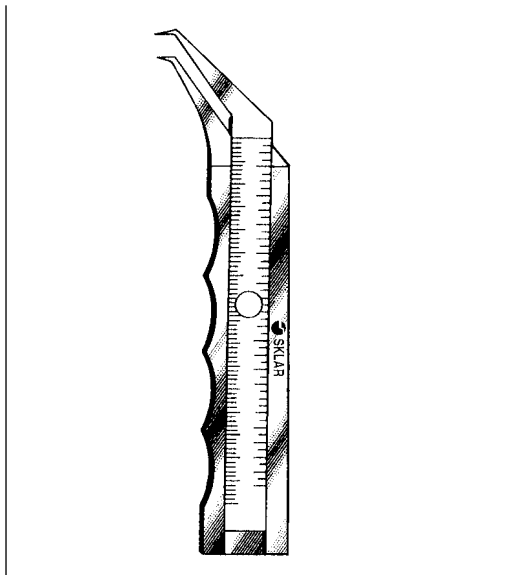
SIMCOE IRRIGATING/ASPIRATING CANNULA

- Reverse 15 mm long
- 66-6930 23 Gauge T.W. x 23 gauge T.W. aspirating port facing into curve,
aspiration on needle hub, irrigation in tubing hub

SIMCOE CANNULA

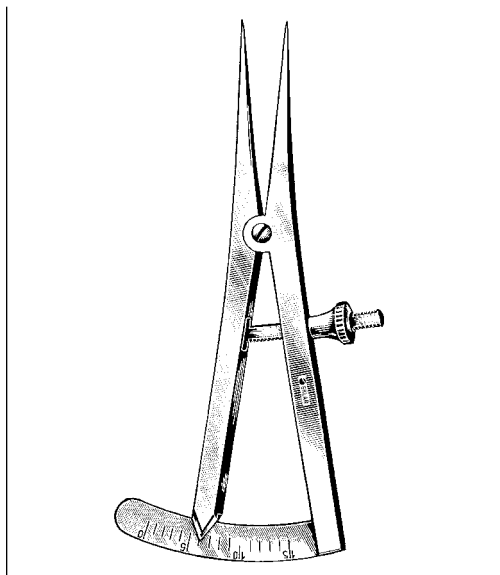
- 23 Gauge Thinwall
- 66-6932 Double barreled irrigating-aspirating

EYE INSTRUMENTS ACCESSORIES



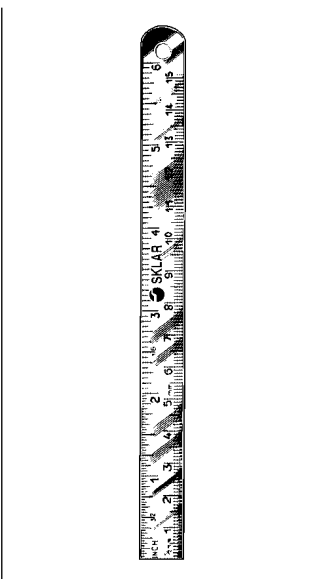
THORPE CALIPER

Graduated in inches and mm
65-6735 4½"



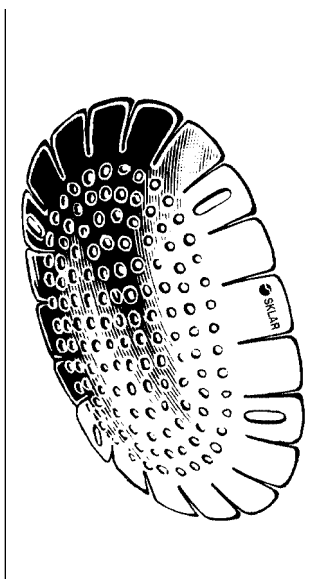
CASTROVIEJO CALIPER

65-6732 3¼"



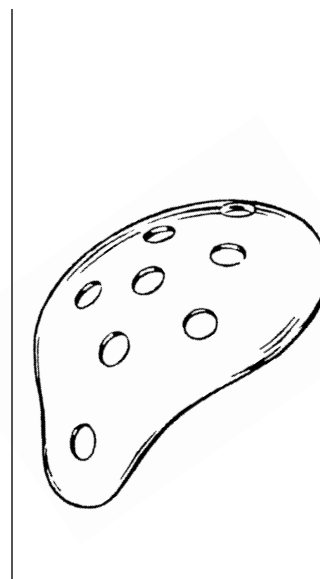
STEEL RULER

Graduated in inches and mm
06-2860 6"



FOX ALUMINUM EYE SHIELD

65-7634 Package of 12
65-7635 Package of 1



DISPOSABLE EYE SHIELDS

96-1070 Single Each
96-1071 Single Dozen
Lighter in weight, Sklar disposable eye shields offer an alternative to metal shields. Made of high impact plastic. Not Autoclavable.



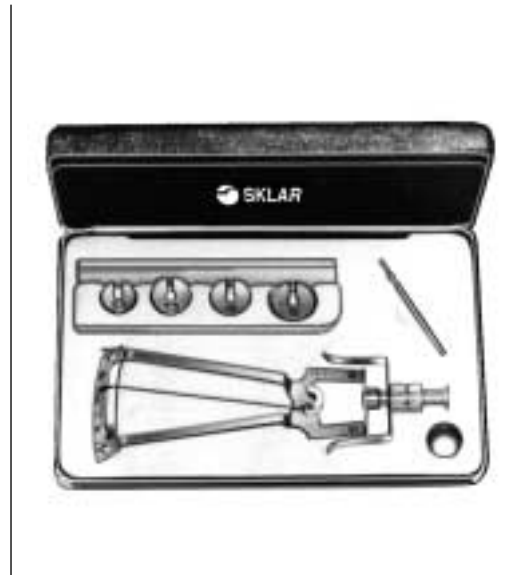
SCHIOTZ TONOMETER

Sklar Original

65-7523

- Screw-on 5.5 gr. weight
- 2 Additional weights 7.5, 10 gr.
- Test Block • Fitted Tonometer Case • Certified

65-7531 Same as 65-7523 with Allen Modification



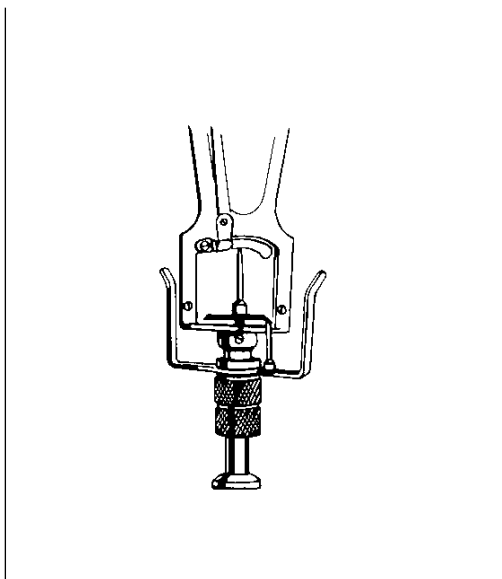
SCHIOTZ TONOMETER

Sklar Exclusive Improved Model

65-7525

- Inclined scale for accurate reading
- 3 Additional weights 7.5, 10 gr, 15 gr.
- Test Block • Fitted Tonometer • Certified

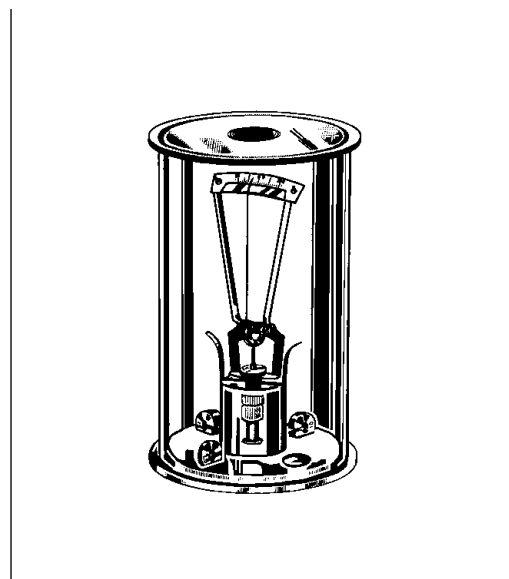
65-7526 Same as 65-7525 with Allen Modification



65-7526 Same as 65-7525 with Allen Modification

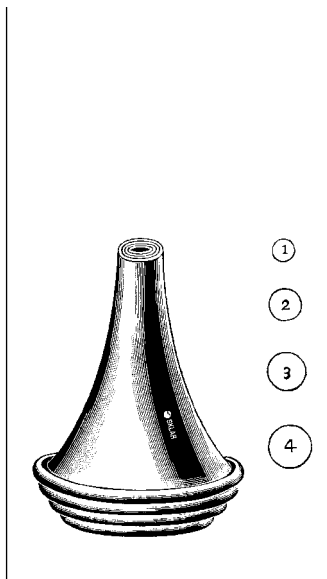
65-7531 Same as 65-7523 with Allen Modification

- Improved Tonometer with Allen modification that retracts the plunger presenting the smooth footplate to the cornea.



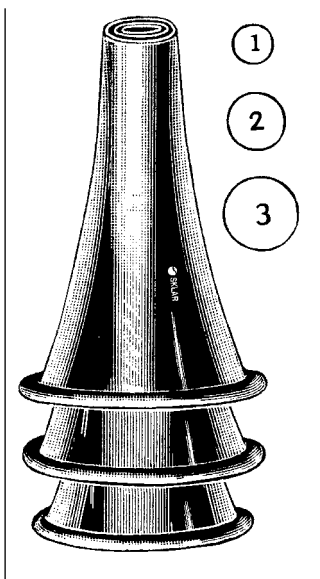
65-7528 Sklar's Tonometer Sterilizing Stand With Cover

Sterilizes safely without heat. Its unique design allows physicians to sterilize with disinfecting solutions.



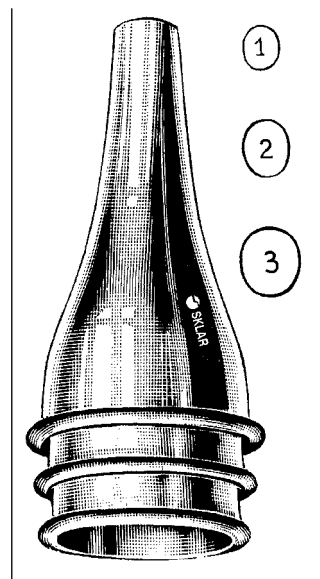
BOUCHERON EAR SPECULUM

Set of 4
67-6010 Chrome



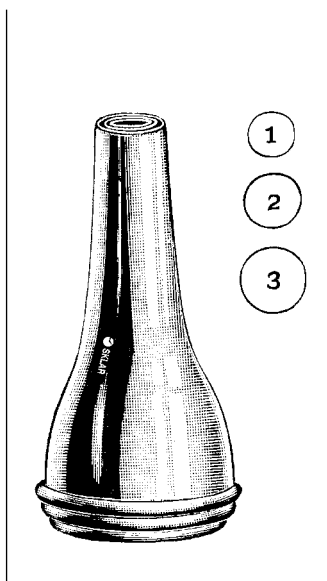
TOYNBEE EAR SPECULUM

67-6030 Set of 3 Chrome
67-6031 Small Chrome
67-6032 Medium Chrome
67-6033 Large Chrome



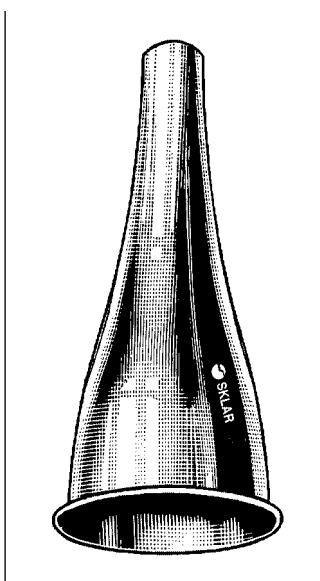
GRUBER EAR SPECULUM

67-6020 Chrome Set of 3
67-6025 Infant Single



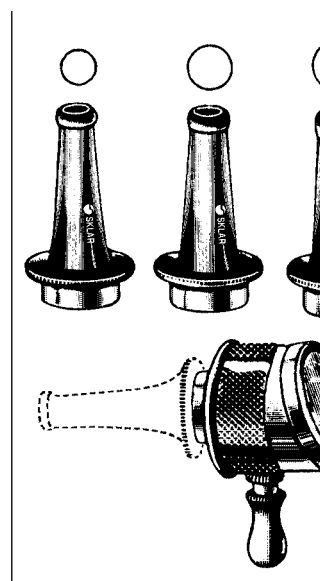
ERHARDT EAR SPECULUM

67-6015 Set of 3



INFANT EAR SPECULUM

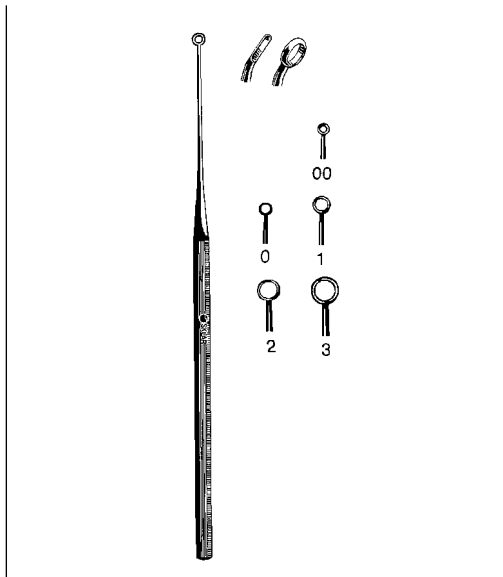
Chrome
67-6025 Single Chrome



BRUENING MAGNIFIER OTOSCOPE

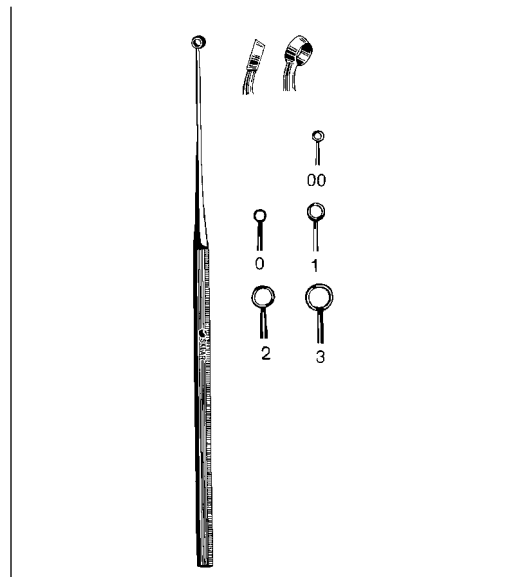
67-6200 Chrome with 3 specula
Small, Medium and Large
Complete with inflation bulb
and tubing.

67-6202 Single speculum, small
67-6204 Single speculum, medium
67-6206 Single speculum, large



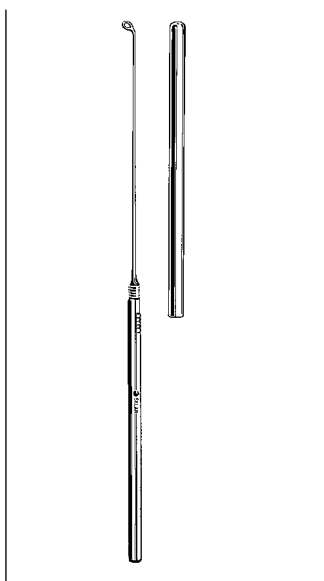
BUCK EAR CURETTE

Blunt		Angled	
Straight			
67-2488	#000	67-2508	#000
67-2489	#00	67-2509	#00
67-2490	#0	67-2510	#0
67-2491	#1	67-2511	#1
67-2492	#2	67-2512	#2
67-2493	#3	67-2513	#3



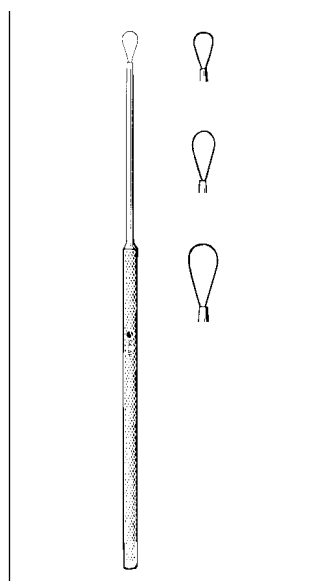
BUCK EAR CURETTE

Sharp		Angled	
Straight			
67-2519	#000	67-2498	#000
67-2514	#00	67-2499	#00
67-2515	#0	67-2500	#0
67-2516	#1	67-2501	#1
67-2517	#2	67-2502	#2
67-2518	#3	67-2503	#3



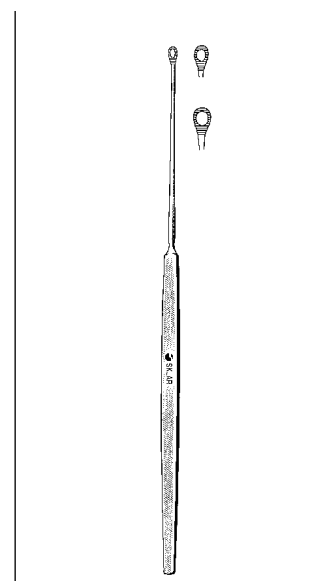
WEISMAN INFANT EAR CURETTE

67-2480	Blunt	Size 0	2 mm
67-2481	Blunt	Size 1	3 mm



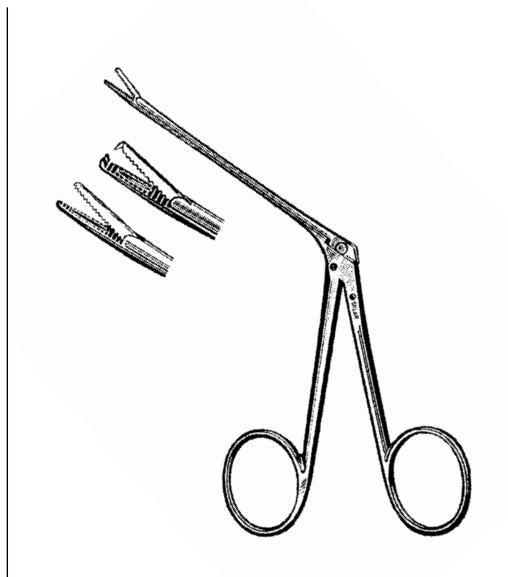
BILLEAU EAR CURETTE

67-2521	Small
67-2522	Medium
67-2523	Large



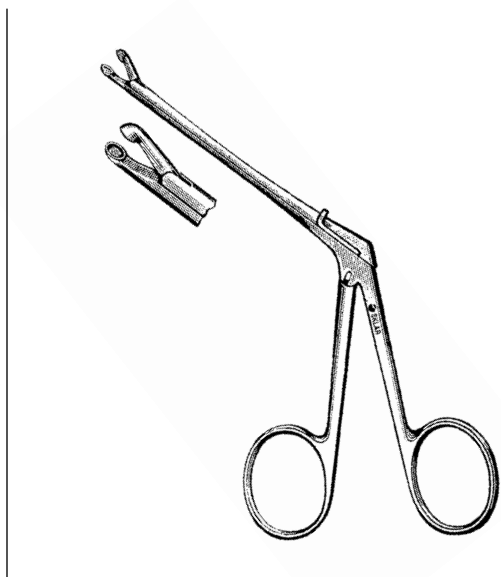
SHAPLEIGH EAR CURETTES

6 1/4" Serrated Loop	
67-2525	Small Size 1
67-2526	Large Size 2



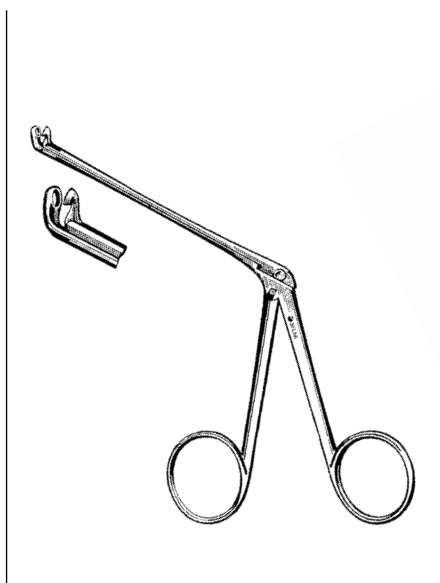
HARTMANN ALLIGATOR GRASPING FORCEPS

- 67-1035 3½" Serrated
- 67-1036 3½" Serrated extra delicate
- 67-1038 5½" Serrated
- 67-1039 6½" Serrated
- 67-1040 3½" 1 x 2 Teeth



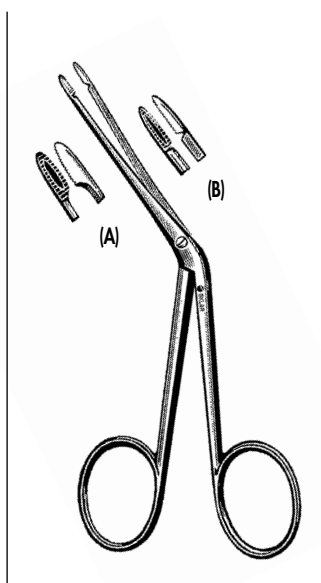
HARTMANN ALLIGATOR ACTION FORCEPS

- Spoon Shaped Jaws
- 67-1020
- 67-1021 (Wullstein) Delicate



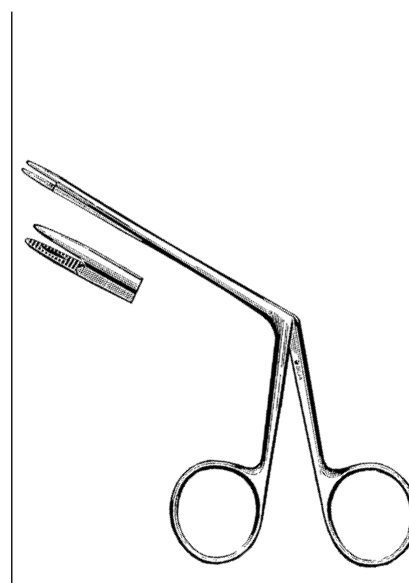
HARTMANN PUNCH ACTION

- 67-1030 Jaws curved up



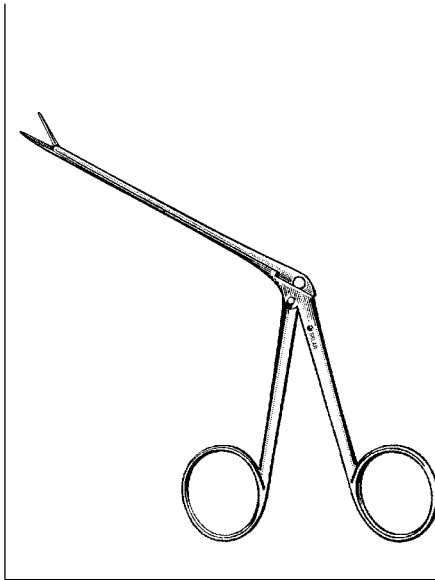
HARTMANN STANDARD PATTERN GRASPING FORCEPS

- 67-1045 Regular-Serrated "A"
- 67-1050 Light-Serrated "B"



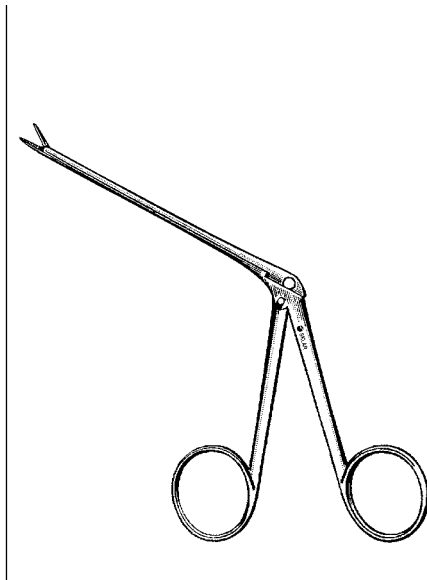
LITTAUER EAR FORCEPS

- 67-1052 Light pattern



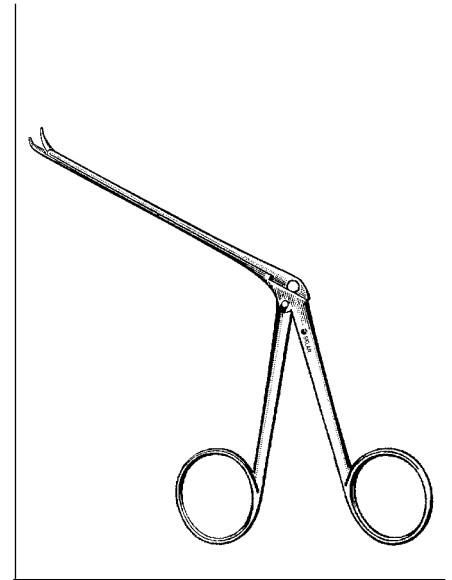
MICRO ALLIGATOR EAR FORCEPS

67-8000 3/4" Shaft long Straight jaw
Serrated



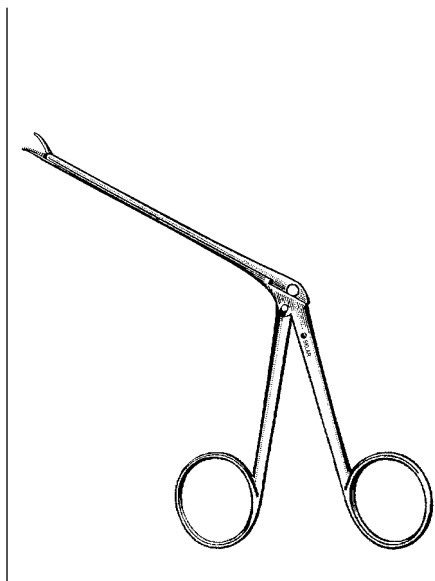
MICRO ALLIGATOR EAR FORCEPS

67-8006 3/4" Shaft short Straight jaw
Serrated



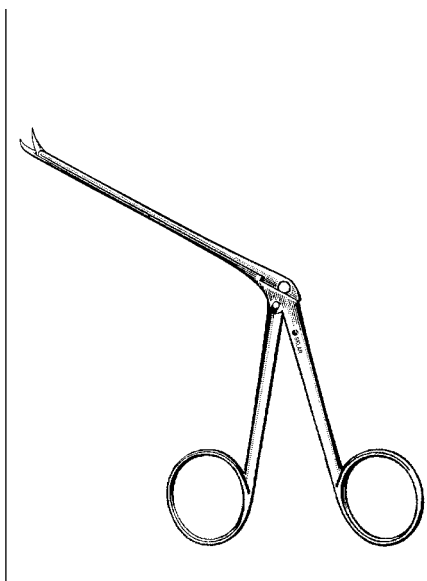
MICRO ALLIGATOR EAR FORCEPS

67-8008 3/4" Shaft short Curved right jaw
Serrated



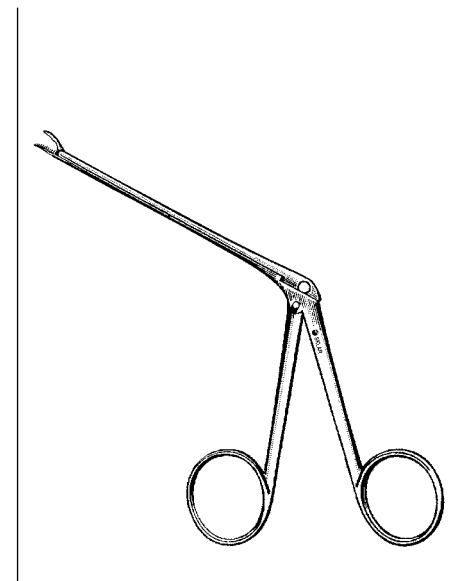
MICRO ALLIGATOR EAR FORCEPS

67-8010 3/4" Shaft short Curved left jaw
Serrated



MICRO ALLIGATOR EAR SCISSORS

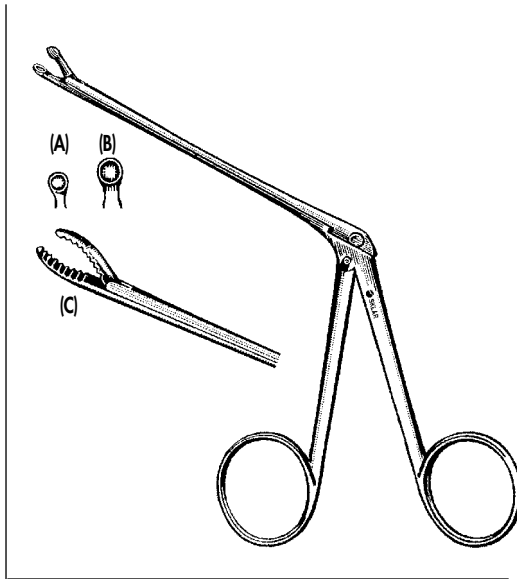
67-8020 3/4" Shaft short
Blades curved right



MICRO ALLIGATOR EAR FORCEPS

67-8024 3/4" Top jaw curved down
Wire closing forceps

EAR INSTRUMENTS



HARTMAN-HERZFELD FORCEPS

Cup-shape Alligator Type

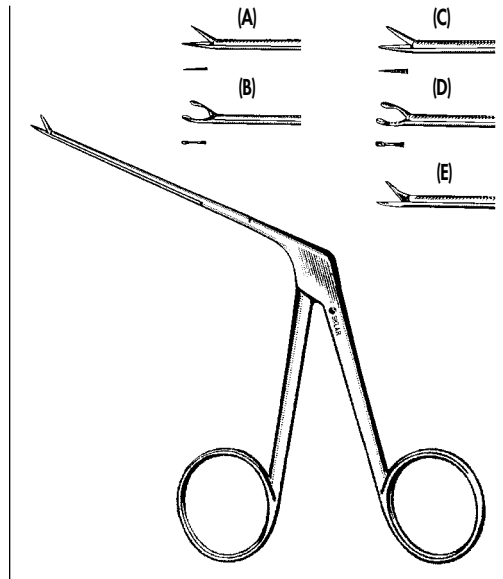
67-8150 3" shaft 2 mm cup (A)

67-8152 3" shaft 3 mm cup (B)

WEINGARTNER EAR FORCEPS

Alligator Type Concave Serrated Jaws

67-8155 3" shaft (C)



MICRO ALLIGATOR EAR FORCEPS

67-8170 3 1/4" Shaft Serrated 0.6 mm (A)

67-8172 3 1/4" Shaft Serrated 0.6 mm Ebony finish (A)

67-8174 3 1/4" Shaft Serrated 0.8 mm (B)

67-8176 3 1/4" Shaft Serrated 0.8 mm Ebony finish (B)

67-8177 3 1/4" Shaft Oval cup 0.5 mm Ebony finish (C)

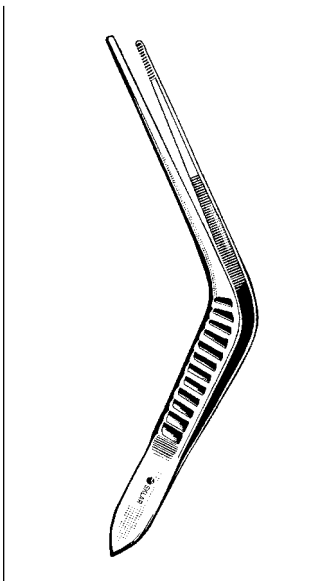
67-8178 3 1/4" Shaft Oval cup 0.8 mm (D)

67-8180 3 1/4" Shaft Oval cup 0.8 mm Ebony finish (D)

BELLUCCI MICRO EAR SCISSORS

4 mm Blades, Ebony Finish

67-8188 2 3/4" Shaft (E)

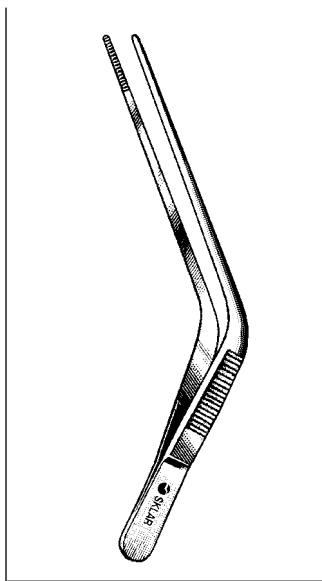


WILDE EAR FORCEPS

Angled

67-1150 5" Serrated

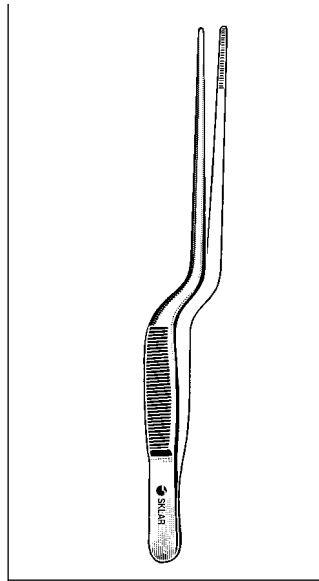
70-4470 7" Serrated



BLAKE EAR FORCEPS

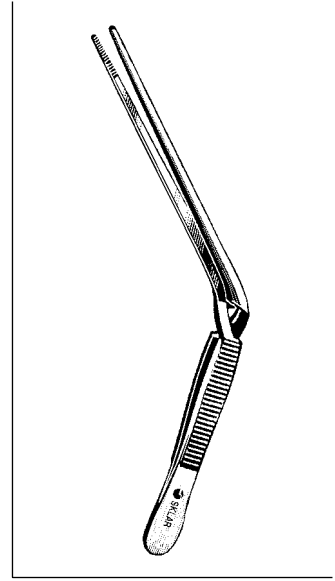
Delicate

67-1058 4 1/2" Angular Serrated



LUCAE BAYONET FORCEPS

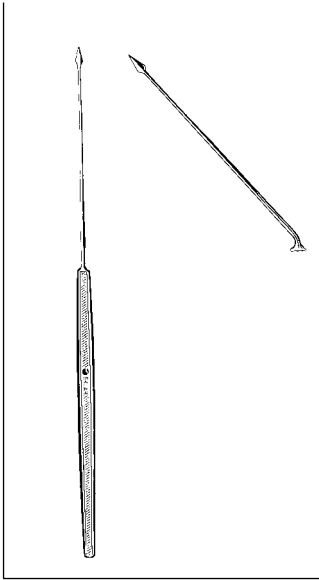
67-1455 5 1/2"



WILDE EAR FORCEPS

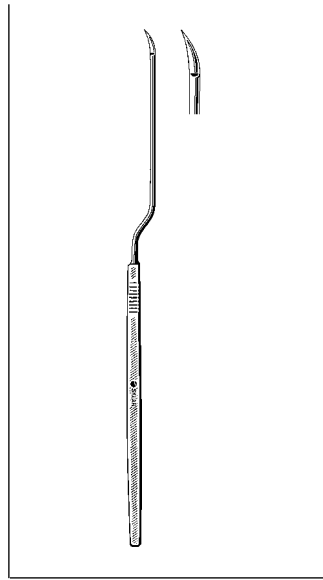
67-1350 5" Cross action, serrated jaws (12.7 cm)

67-1450 5" With mouse tooth



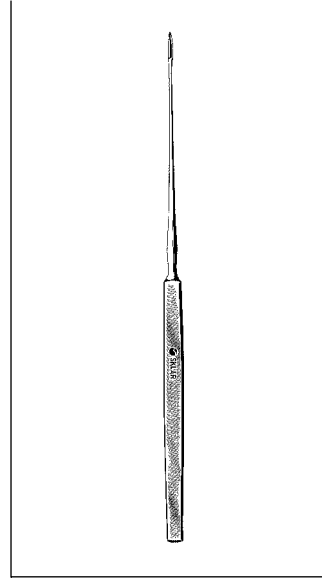
POLITZER EAR KNIFE

67-2005 Straight
67-2007 Angular



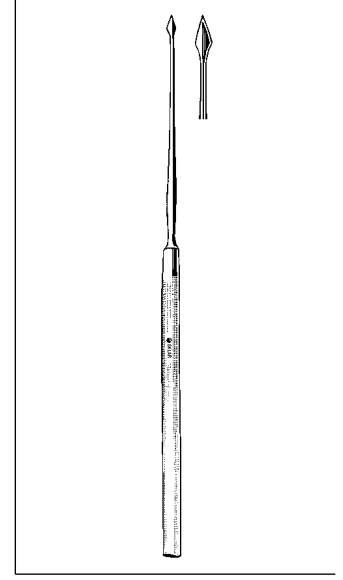
WILLIAMS BAYONET PERFORATOR

67-2145



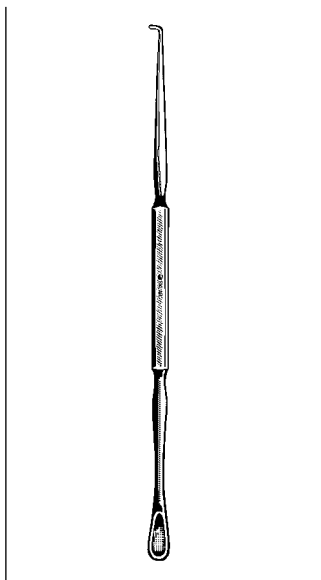
GERZOG (SEXTON) EAR KNIFE

67-2015 Straight



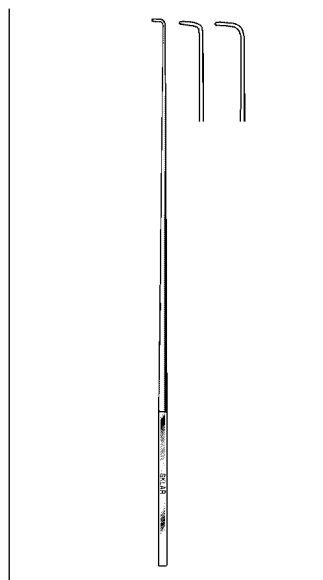
BUCK MYRINGOTOME

67-2115



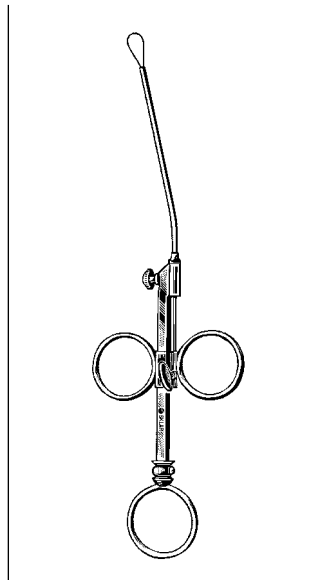
GROSS HOOK AND SPOON

Double Ended
67-2540



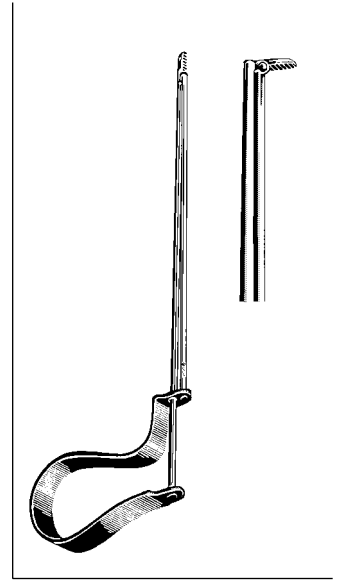
DAY EAR HOOK

67-2550 6½" Small
67-2552 6½" Large



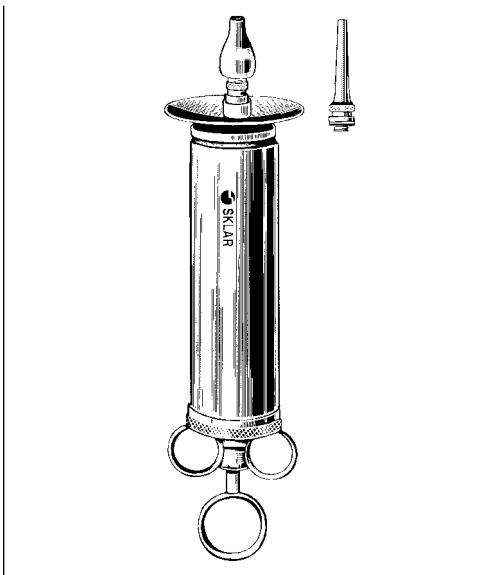
KRAUSE EAR SNARE

With 1 Dozen Snare Wires
67-1750 Complete
67-1751 Stylet only for 67-1750
67-1753 Cut and Bent Snare Wires
#4 for 67-1750 1 Dozen
67-1752 Cut and Bent Snare Wires
#4 for 67-1750 1 Gross



QUIRE FOREIGN BODY INSTRUMENT

Spring Handle
67-1732 4"



POMEROY EAR SYRINGE ALL METAL

Chrome Plated

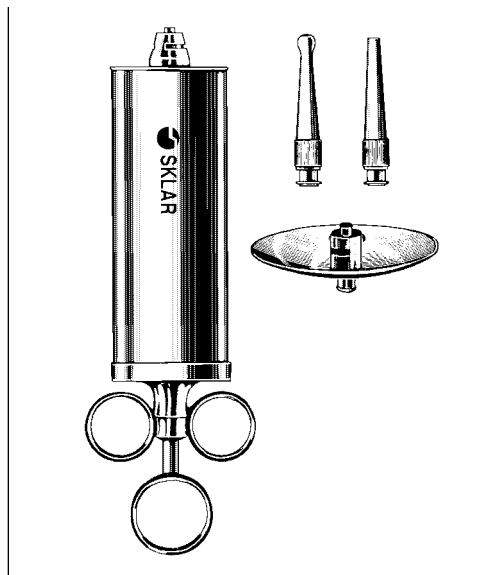
67-3402 Complete 2 oz.

67-3404 Complete 4 oz.

67-3410 Shield only for Ear Syringe

67-3411 Conical tip only for Ear Syringe

67-3412 Bulbous tip only for Ear Syringe



CONTINUOUS EAR SYRINGE APPARATUS

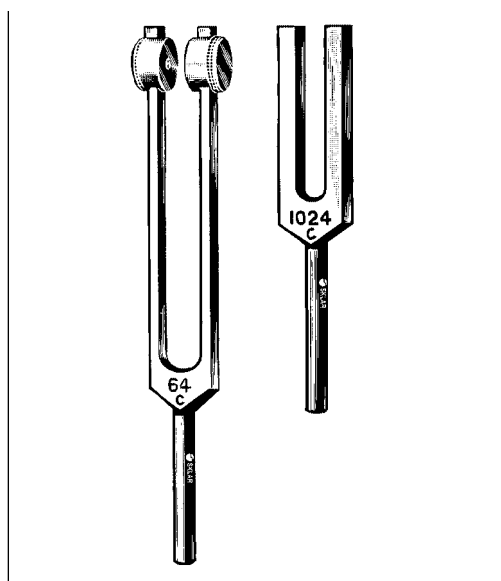
67-3415 Complete Set



TUNING FORK SET

Set of 5 Aluminum Alloy

67-7605 Including C-128 C-1024
C-256 C-2048
C-512



SKLAR ALUMINUM ALLOY TUNING FORK

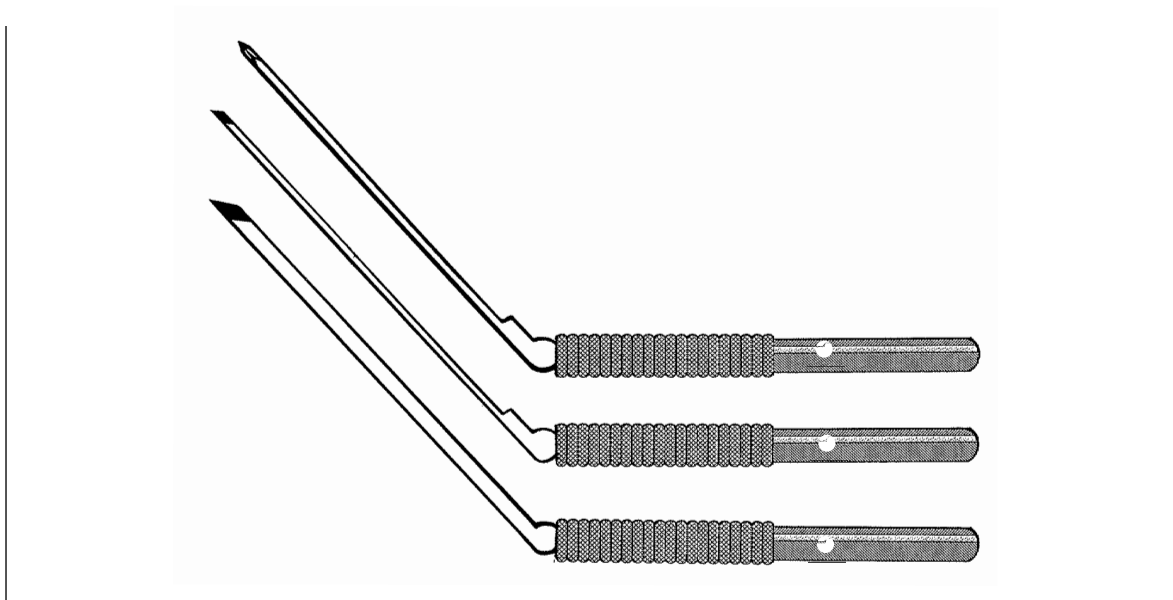
67-7064 C-64 67-7524 C-1024
67-7128 C-128 67-7548 C-2048
67-7256 C-256
67-7512 C-512



DISPOSABLE EAR CURETTE

Pack of 12		Non-Autoclavable
96-1000	Cup End	12 Each
96-1001	Cup End	50 Each
96-1005	Loop End	12 Each
96-1006	Loop End	50 Each
96-1010	Ring End	12 Each
96-1011	Ring End	50 Each

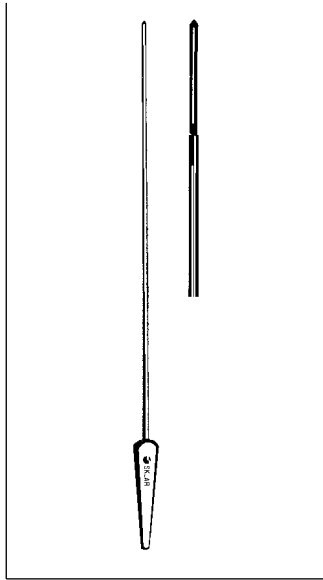
Manufactured from a cold sterilizable polymer. Sklar Ear Spoons and Ear Loops are inexpensive and effective. Firm, yet pliable, these disposable curettes eliminate the risk of cross infection.



DISPOSABLE MINIATURE EAR KNIVES

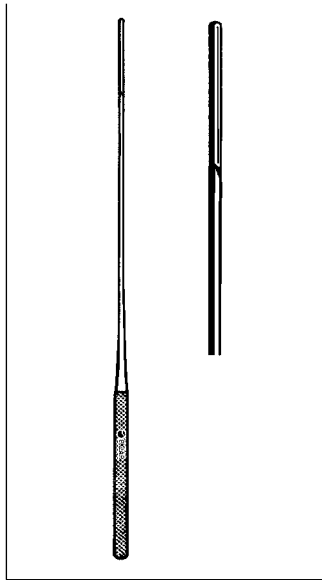
Sterile Pack of 12 Non-Autoclavable		
67-2020	Ear Knife Angled	Broad Tip 71
67-2022	Ear Knife Angled	Narrow Tip 71-N
67-2024	Ear Knife Angled	Spear Tip 71-S

APPLICATORS



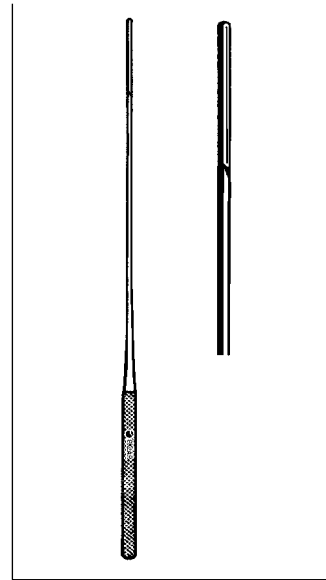
BROWN APPLICATOR

- 68-1057 5 $\frac{3}{4}$ " Twisted
- 68-1157 5 $\frac{3}{4}$ " Twisted Copper
- 68-1257 5 $\frac{3}{4}$ " Triangle
- 68-1357 5 $\frac{3}{4}$ " Triangle Copper



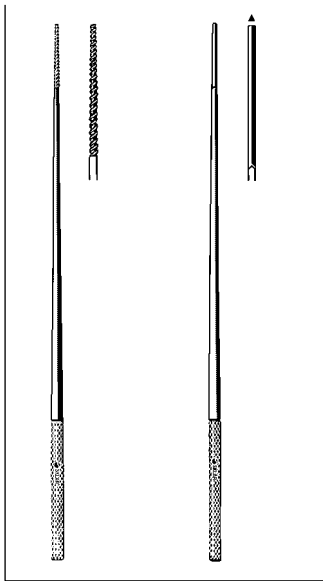
KYLE APPLICATOR

- 68-1557 5 $\frac{3}{4}$ " Triangle



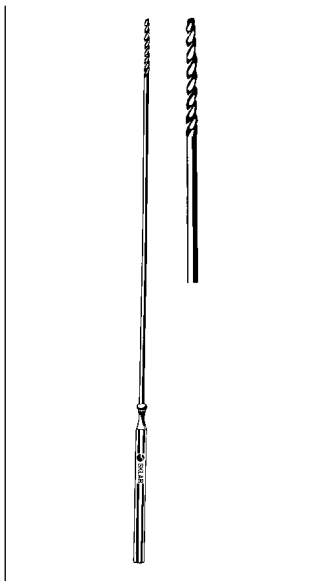
SAWTELL APPLICATOR

- 68-1665 6 $\frac{1}{2}$ " Triangle



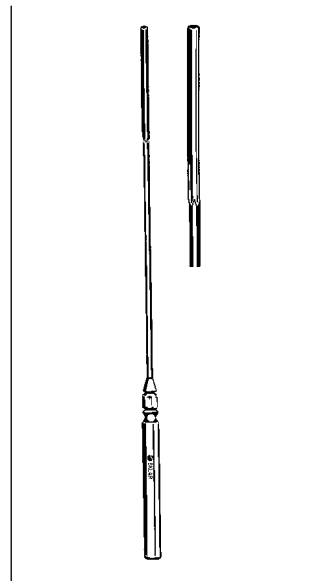
FARRELL APPLICATOR

- 68-1765 6 $\frac{1}{2}$ " Twist End
- 68-1865 6 $\frac{1}{2}$ " Triangle End
- 68-1890 9" Triangle End



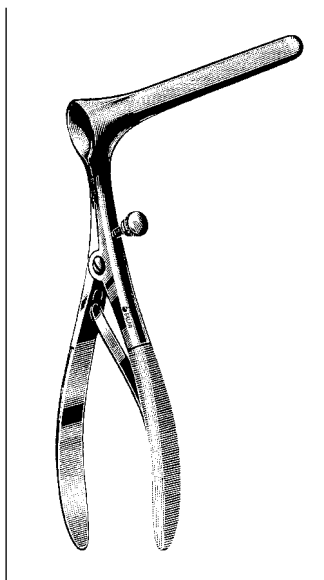
BUCK APPLICATOR

- 68-2175 7 $\frac{1}{2}$ " Twisted



BUCK APPLICATOR

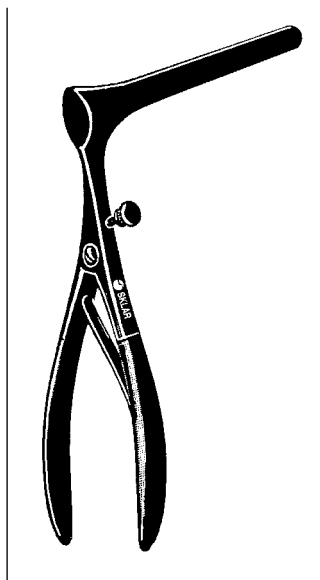
- 68-1050 5" Triangle



COTTLE SEPTAL SPECULUM

With Set Screw

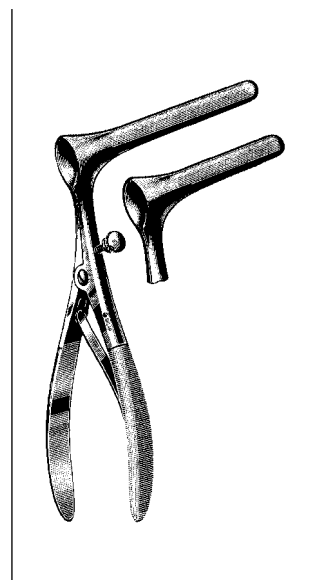
- 41-1190 6" Long 1½" Blade
- 41-1192 6" Long 2" Blade
- 41-1194 6" Long 3" Blade
- 41-1196 6" Long 3½" Blade



BLACK FINISH COTTLE SEPTAL SPECULUM

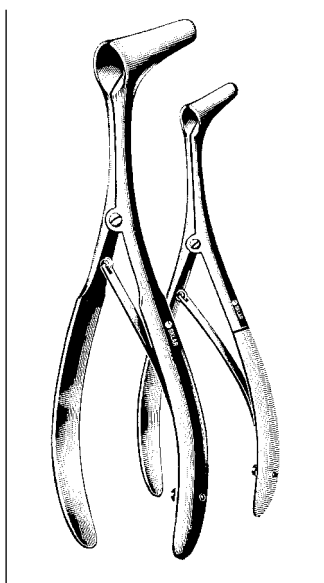
With Set Screw

- 41-1198 6" x 2"
- 41-1200 6" x 3"



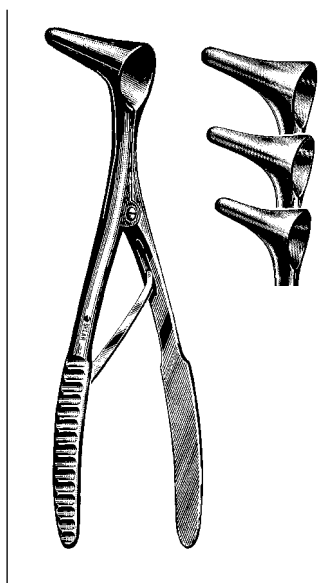
KILLIAN NASAL SPECULUM

- 70-1020 Small 2"
- 70-1030 Medium 3"
- 70-1035 Large 3½"



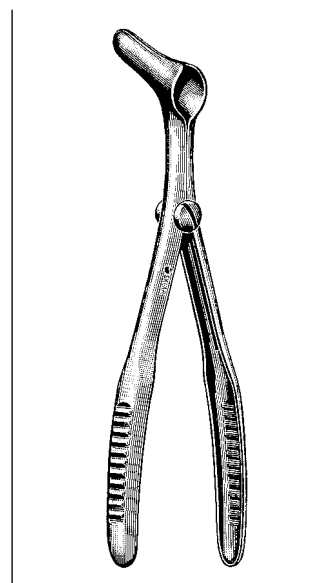
HALLE NASAL SPECULUM

- 70-1040 Infant
- 70-1041 Adult



VIENNA NASAL SPECULUM

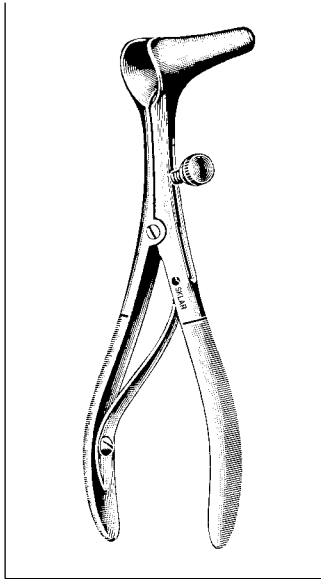
- 70-1070 Infant
- 70-1071 Child
- 70-1072 Adult



VIENNA NASAL SPECULUM

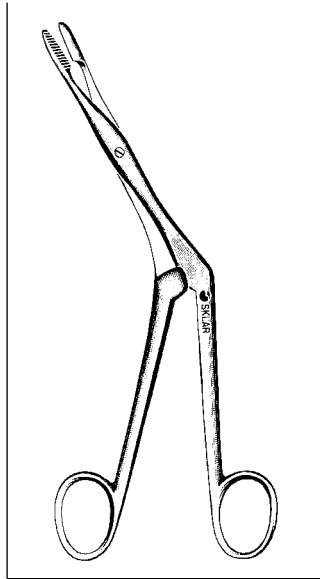
- Wrought Metal-Lightweight
- 70-1075 Adult

NASAL INSTRUMENTS



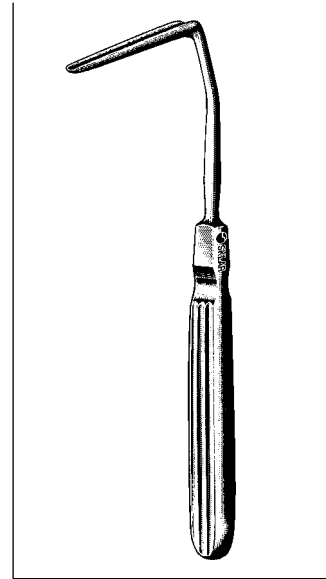
GERZOG NASAL SPECULUM

With Set Screw
70-1060 Adult



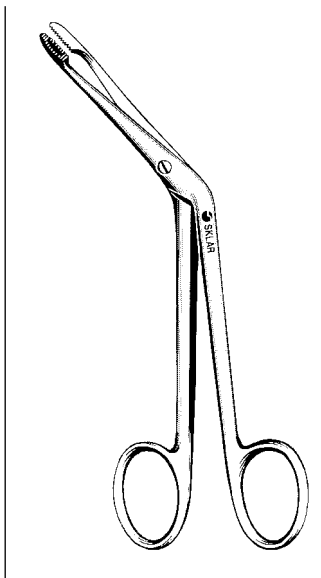
KNIGHT DRESSING FORCEPS

70-4075 7½"



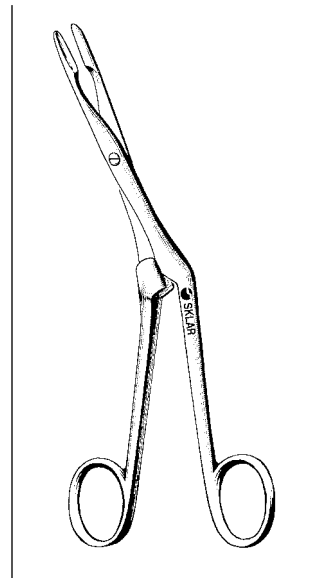
AUFRICHT RETRACTOR

Solid Blade
41-1410 7¼" x 45 mm



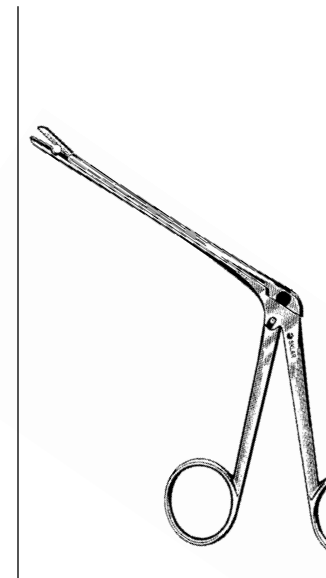
HARTMANN NASAL FORCEPS

70-4160 6"



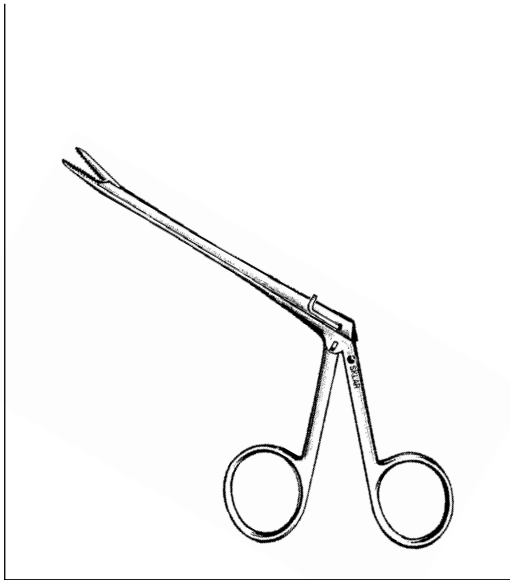
KNIGHT SEPTUM FORCEPS

Cup Cutting Jaws
70-5170 7"



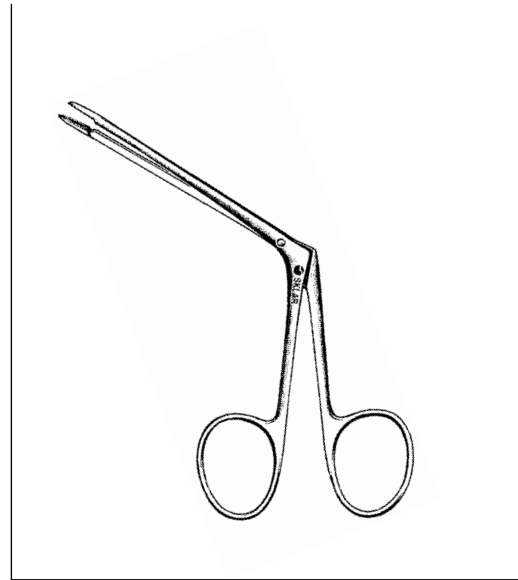
TAKAHASHI FORCEPS

70-5090 Slender Cup Jaws



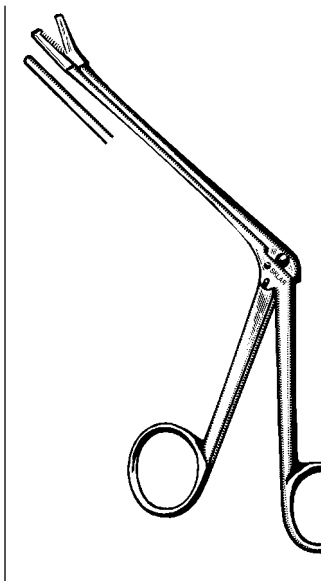
**NOYES ALLIGATOR
FORCEPS**

- 70-5332 3¼" Serrated
- 70-5335 5½" Serrated
- 70-5232 3¼" 1 x 2 Teeth
- 70-5235 5½" 1 x 2 Teeth



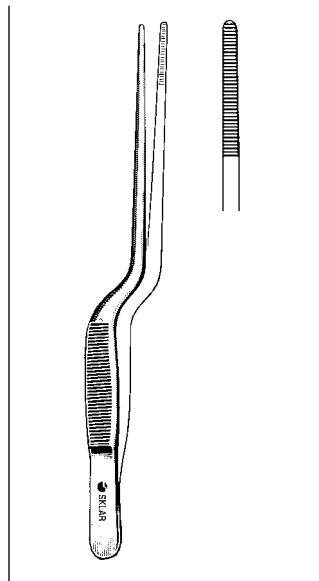
**LITTAUER
NASAL FORCEPS**

- 70-4170 5" Shaft
- 67-1052 3" Shaft (Light Pattern)



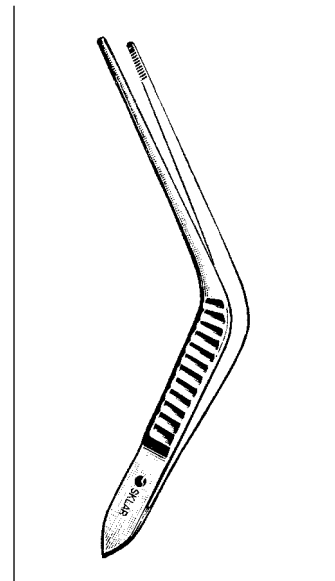
**STRUYCKEN CUTTING
FORCEPS**

- 70-5176 Size 1
5" shaft with handgrip



**JANSEN
NASAL FORCEPS**

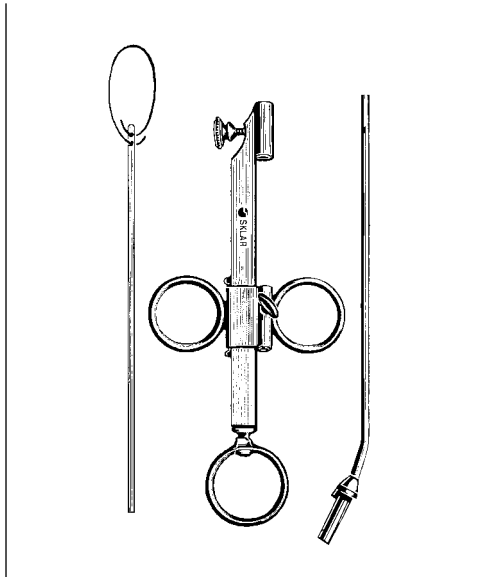
- 67-1465 6½"
- 70-4375 7½"
- 70-4385 8½"



WILDE NASAL FORCEPS

- 70-4470 7" Angular Serrated
- 67-1150 6" Angular Serrated

NASAL PLASTIC INSTRUMENTS



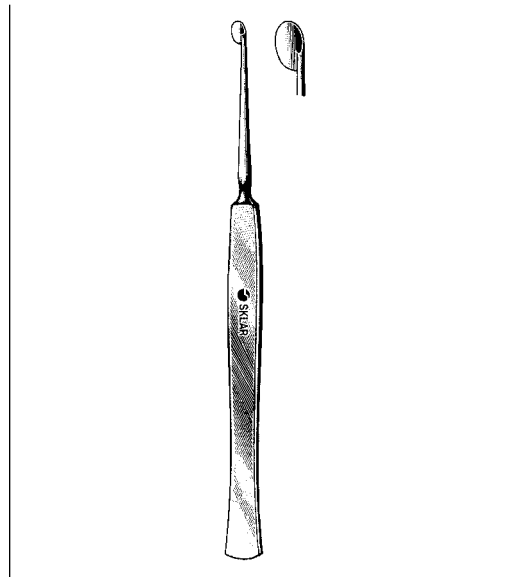
KRAUSE NASAL SNARE

With 1 Dozen Snare Wires

70-6165 4" Shaft

70-6166 Stylet only for 70-6165

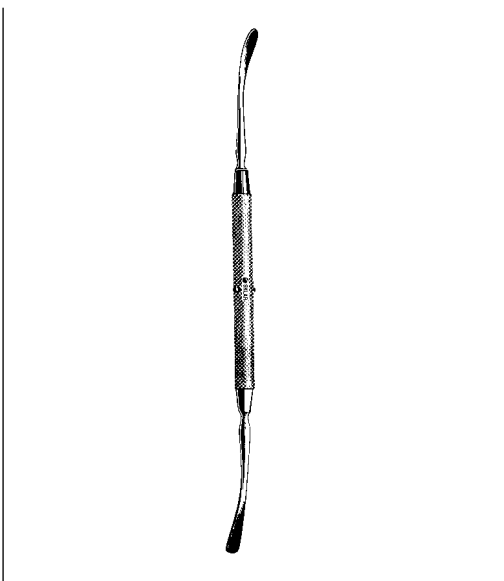
70-6168 Cut and Bent Snare Wires only #6 for 70-6165



FREER SEPTUM KNIFE

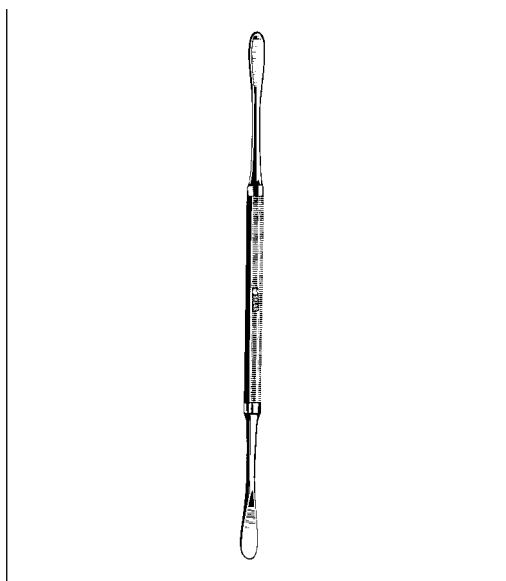
Half Round Blade

70-7062 6 1/2"



FREER SEPTUM ELEVATOR

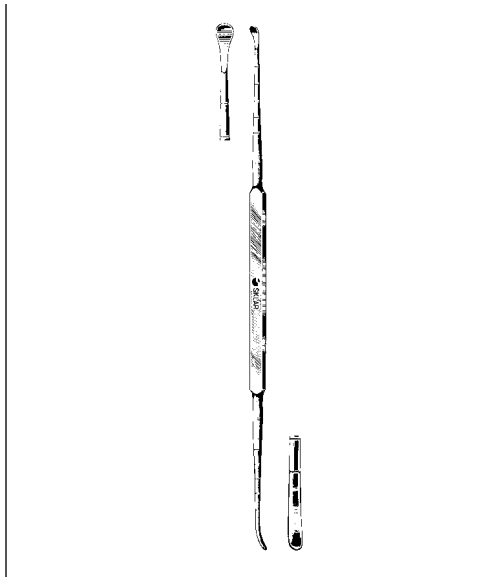
47-2380 7 1/4" Narrow



BALLENGER SEPTUM ELEVATOR

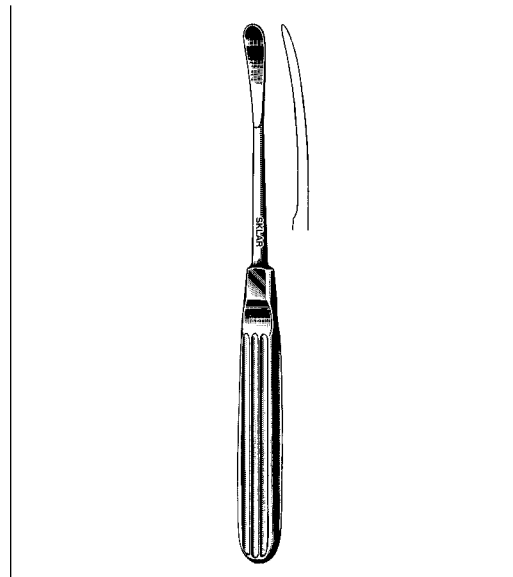
Double Ended

70-7185 8 1/2" S/B Wide



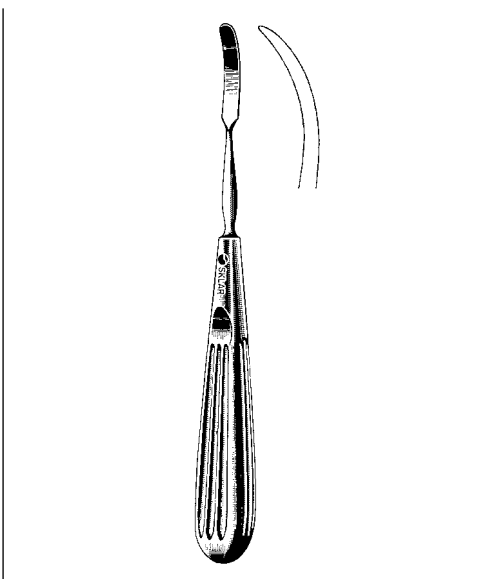
COTTLE ELEVATOR

Shaft Graduated in cm
41-1235 9" Double End



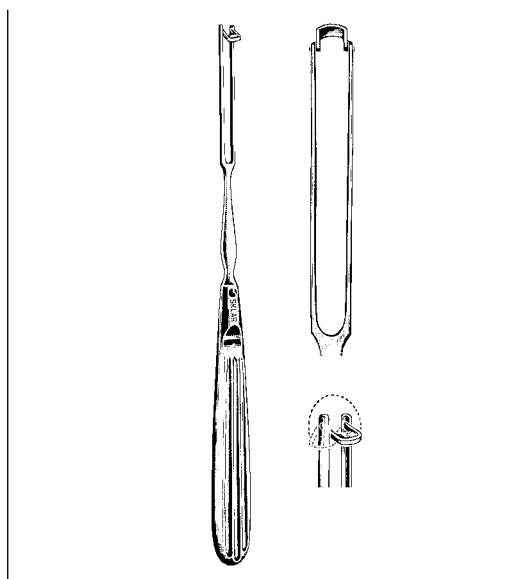
COTTLE ELEVATOR

Slight Curve
41-1250 7½" 9 mm



JOSEPH PERIOSTEAL ELEVATOR

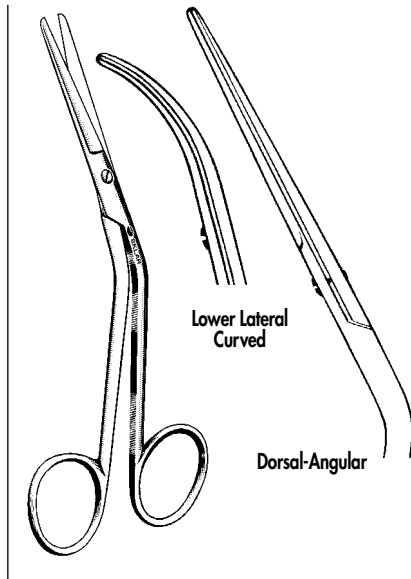
41-1240 7" 6.5 mm



BALLENGER SWIVEL KNIFE

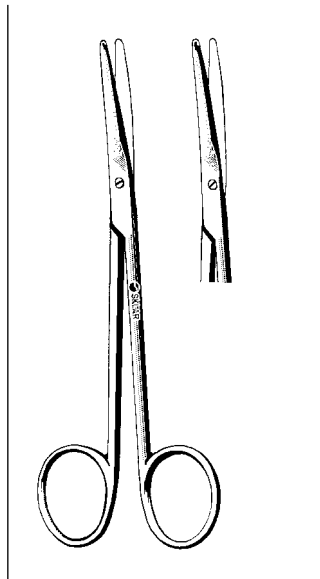
Bayonet
70-7503 7¼" 3 mm
70-7504 7¼" 4 mm

NASAL PLASTIC INSTRUMENTS



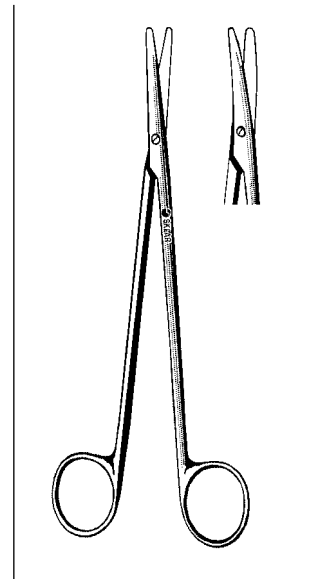
FOMON SCISSORS

70-4352 5 1/4" Lower Lateral-Curved
70-4350 5" Dorsal-Angular



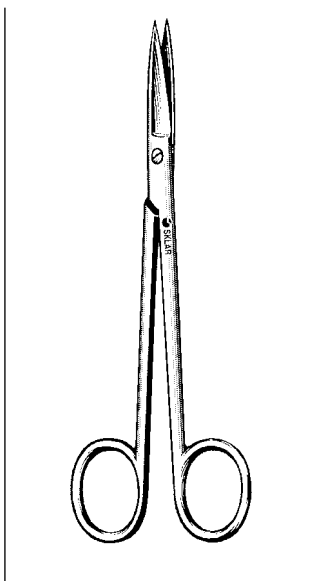
METZENBAUM-LAHEY SCISSORS

Delicate
22-2450 4 3/4" Straight
22-2460 4 3/4" Straight



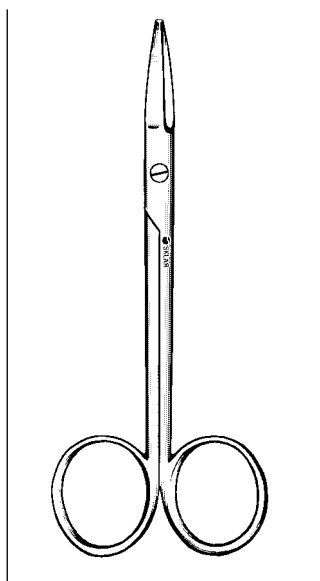
METZENBAUM DISSECTING SCISSORS

Straight
75-5570 7" Standard
22-1071 7" Delicate
Curved
75-5670 7" Standard
22-1070 7" Delicate



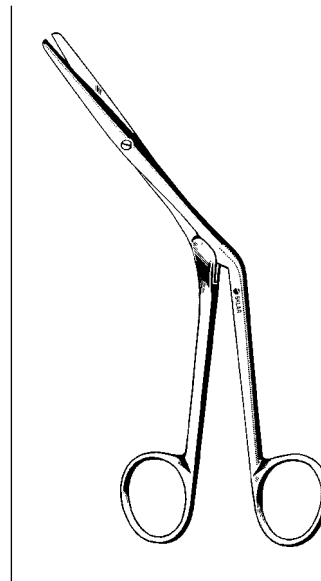
JOSEPH SCISSORS

41-1050 5 3/4" Straight



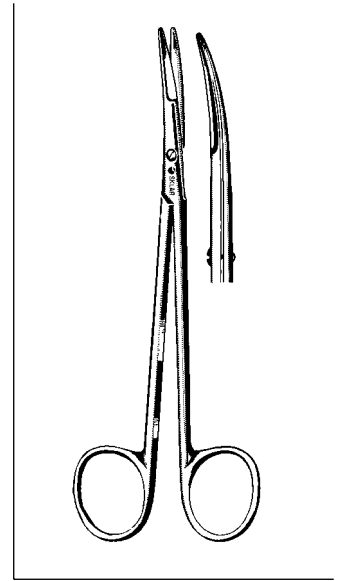
JOSEPH SCISSORS

Double Edge
41-1058 5 3/4" Straight



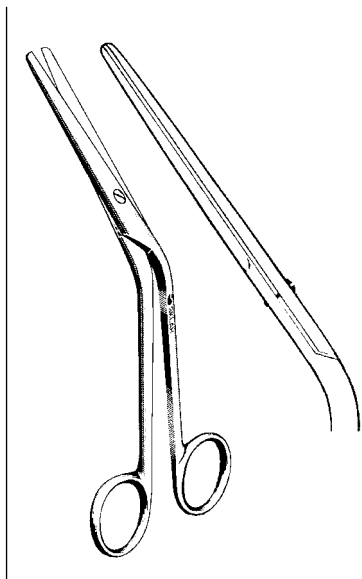
KNIGHT NASAL SCISSORS

70-4262 6 1/4"



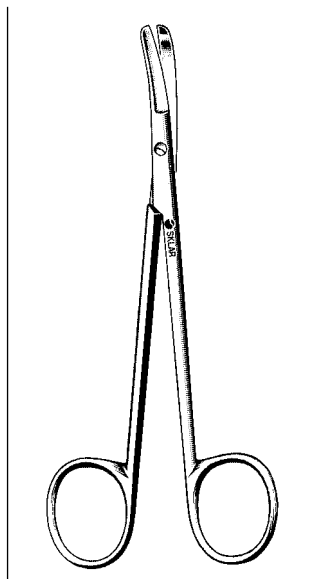
GLASSMAN THIN POINT DISSECTING SCISSORS

Slightly Curved Tips
41-1045 5"
41-1047 7"



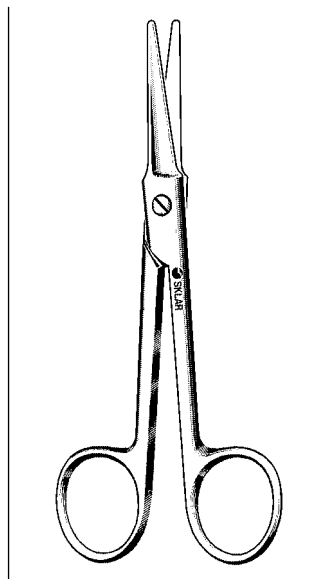
**COTTLE NASAL
SCISSORS**

Strong Short Bent
41-1169 6¼" Angular



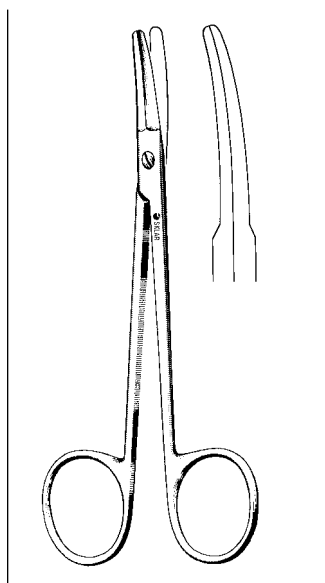
**COTTLE DORSAL
SCISSORS**

Strong Short Blades
41-1168 4½" Curved



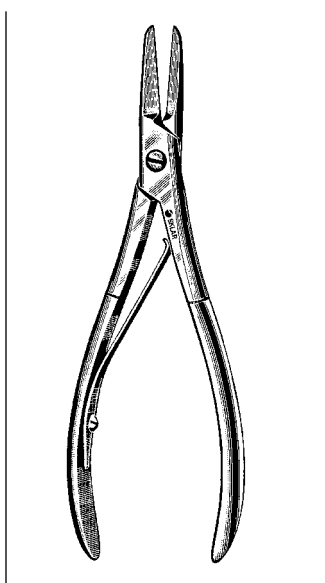
**BROWN DISSECTING
SCISSORS**

Heavy Pattern
41-1078 5½" Straight
41-1079 5½" Curved



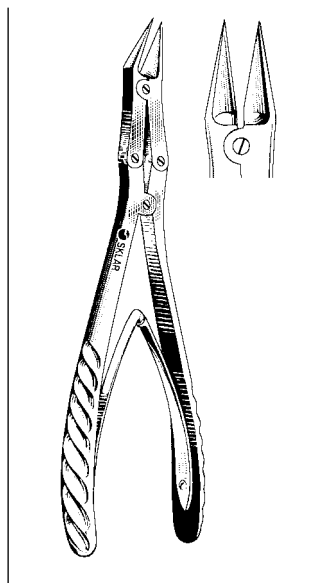
**FOMON SABER BACK
SCISSORS**

Semi Sharp Back Edges
41-1076 5½" Curved



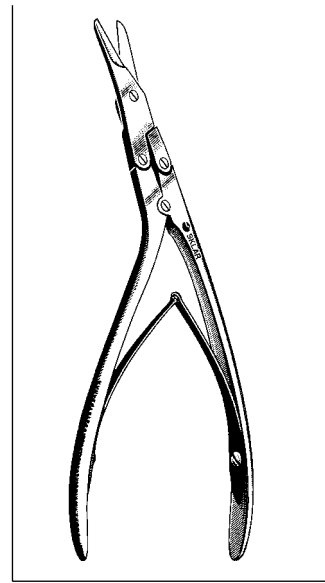
**KAZANJIAN NASAL
FORCEPS**

Cutting Blades
70-4275 7½"



**MCINDOE BONE
CUTTING FORCEPS**

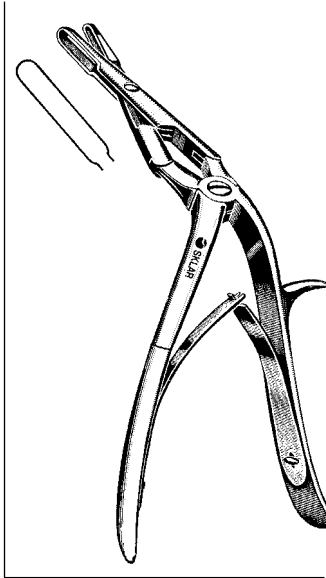
Double Action
41-1170 7½" Slight Angle



**CAPLAN DORSAL
SCISSORS**

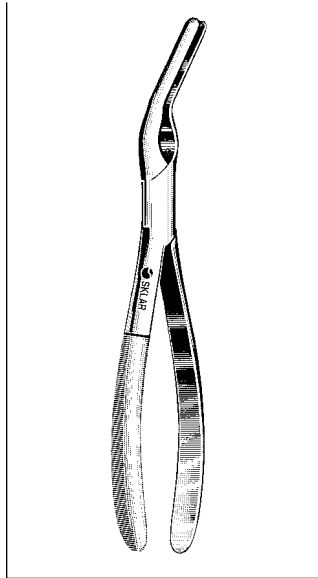
Double Action
41-1145 7½" Serrated

NASAL PLASTIC INSTRUMENTS



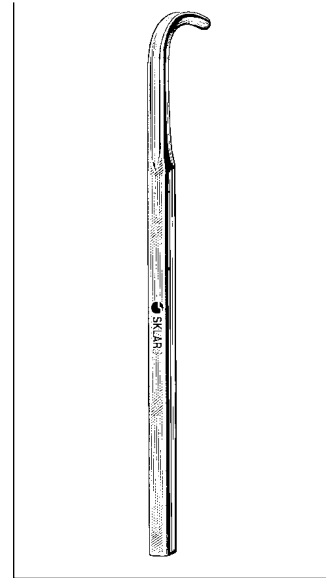
JANSEN-MIDDLETON SEPTUM FORCEPS

Double Action
70-5673 7½" Cutting



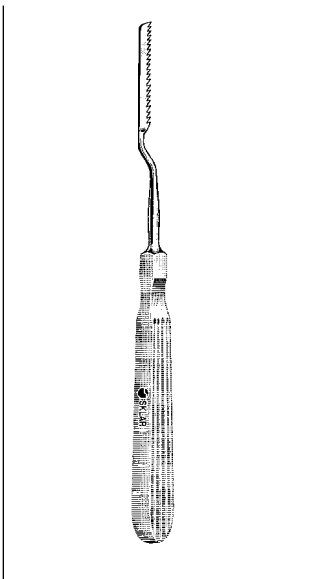
ASH SEPTUM STRAIGHTENING FORCEPS

70-5190 9"



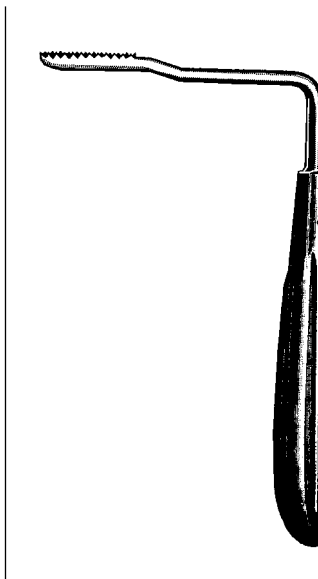
JOSEPH SAW

41-1320 4 mm Curved



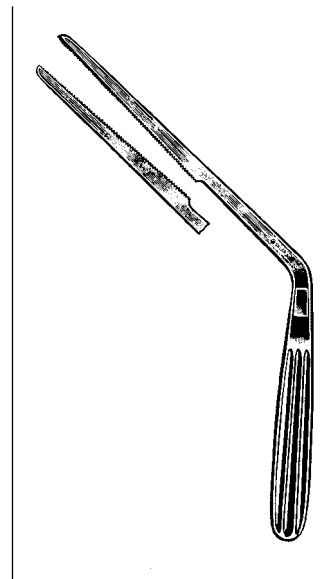
JOSEPH BONE SAW

Bayonet
70-7801 7½" Right
70-7802 7½" Left



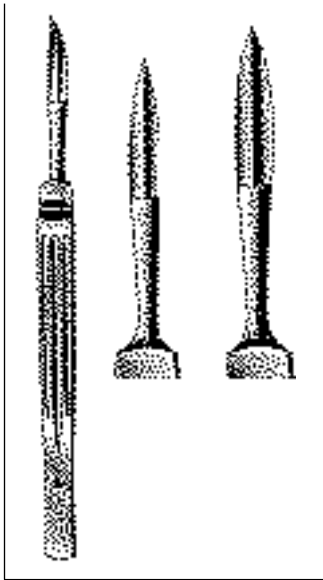
JOSEPH NASAL BONE SAW

Stainless Steel
70-7821 Right Blade
70-7822 Left Blade



BOSWORTH NASAL SAW

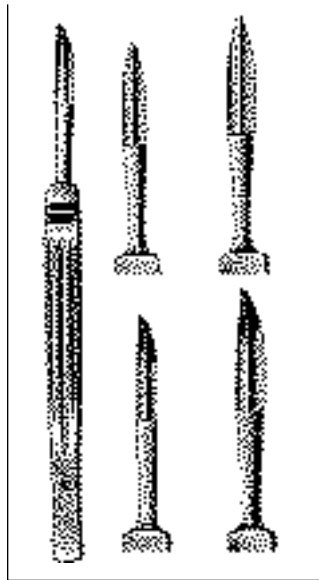
Stainless Steel
70-7811 Angular, up cutting
Blade only
70-7812 Down cutting
70-7813 Straight



JOSEPH KNIFE

Sharp Point

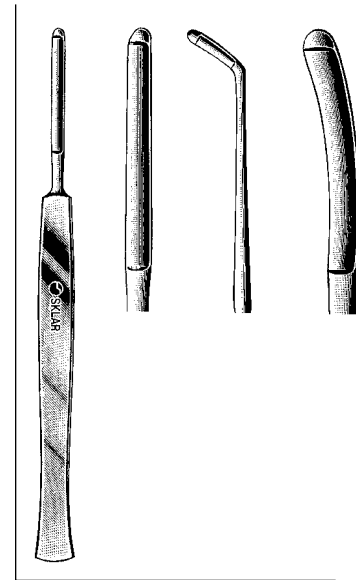
41-1260	6"	Small, Straight
41-1262	6"	Large, Straight
41-1264	6"	Small, Curved
41-1266	6"	Large, Curved



JOSEPH KNIFE

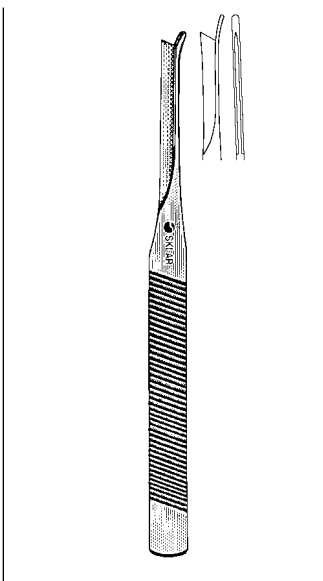
Blunt Point

41-1270	6"	Small, Straight
41-1272	6"	Large, Straight
41-1274	6"	Small, Curved
41-1276	6"	Large, Curved



JOSEPH BUTTON END KNIFE

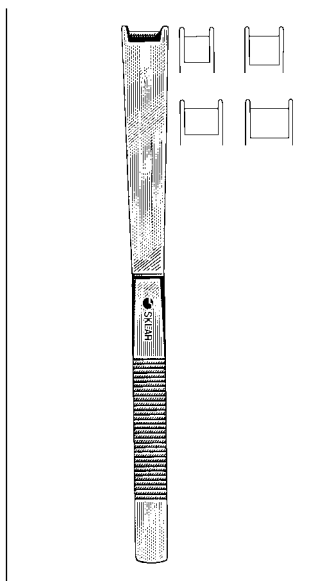
41-1300	6"	Straight
41-1305	6"	Angular
41-1310	6"	Curved



SILVER OSTEOTOME

Guarded One Side

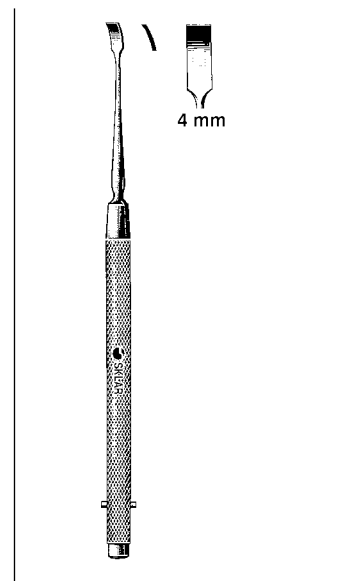
41-1350	7"	Straight
41-1355	7"	Curved Right
41-1360	7"	Curved Left



CINELLI OSTEOTOME

Guarded Both Sides

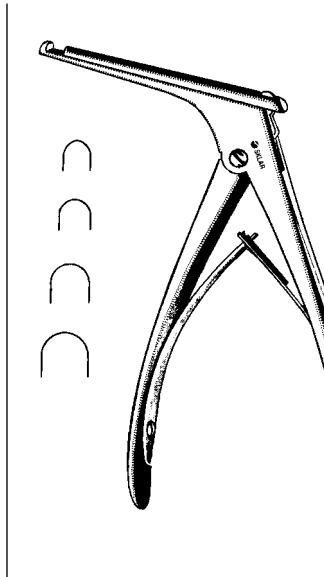
41-1370	Straight	6½" x 10 mm
41-1372	Straight	6½" x 12 mm
41-1374	Straight	6½" x 14 mm
41-1376	Straight	6½" x 16 mm



FREER CHISEL

41-1330	6½"	Straight	4 mm
41-1332	6½"	Curved	4 mm

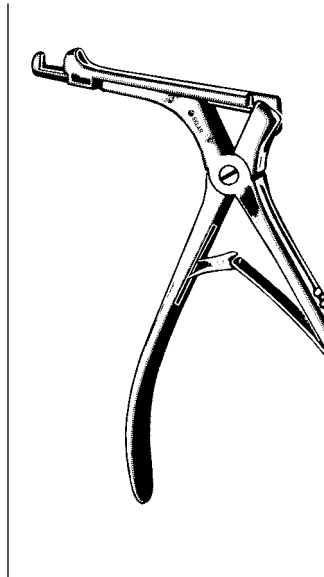
NASAL PLASTIC INSTRUMENTS



KERRISON RONGEURS

2 3/4" Shaft

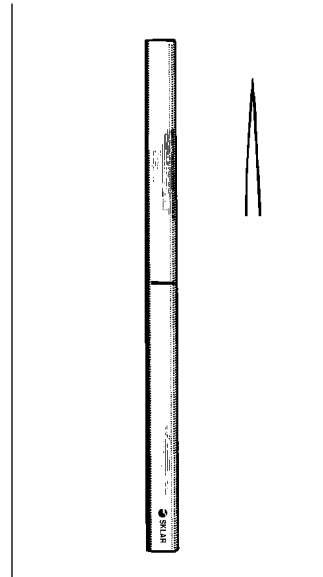
65-7400	Size 0	3.5 mm
65-7401	Size 1	4.5 mm
65-7402	Size 2	5.5 mm
65-7403	Size 3	6.5 mm



CITELLI RONGEURS

2 1/2" Shaft

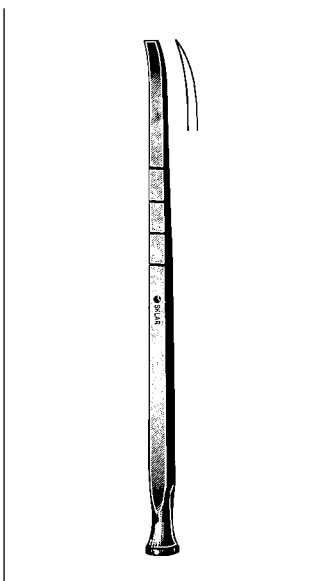
65-7410	Size 1	2 mm
65-7411	Size 2	3 mm
65-7412	Size 3	4 mm



LAMBOTTE OSTEOTOMES

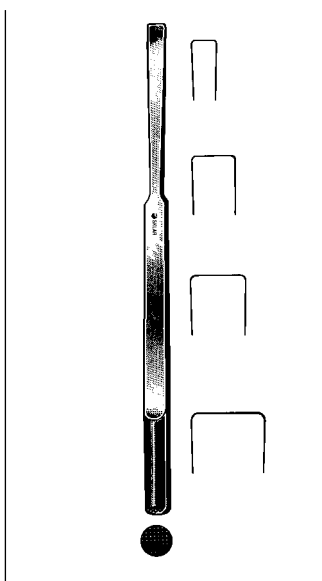
5 1/2"

40-6535	5 mm
40-6537	7 mm



COTTLE NASAL CHISEL

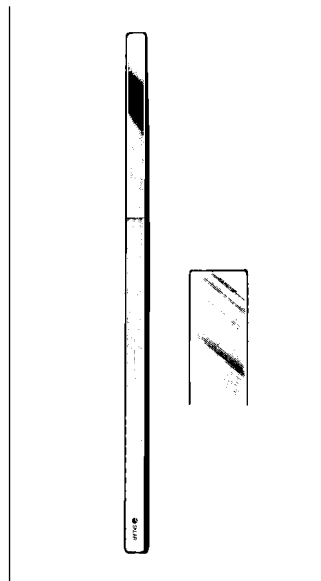
41-1340 6 1/2" Curved



COTTLE NASAL CHISELS

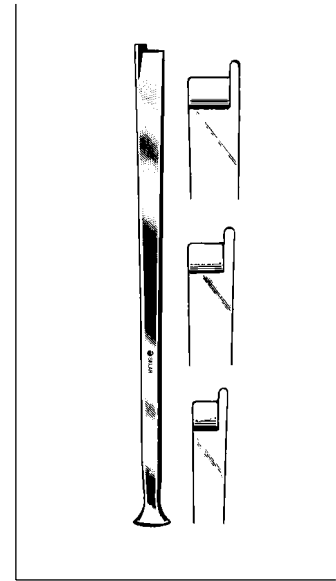
7" With Rounded Corners

41-1342	4 mm
41-1344	7 mm
41-1346	9 mm
41-1348	12 mm



COTTLE BONE LEVER

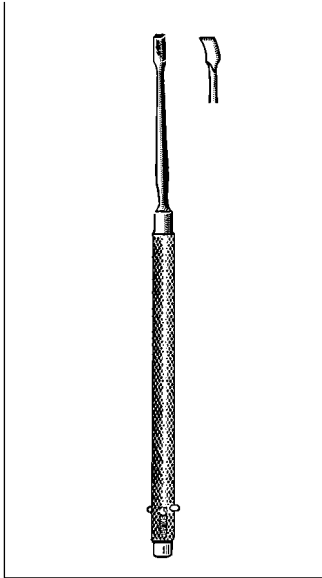
41-1365 8"



FOMON NASAL CHISELS

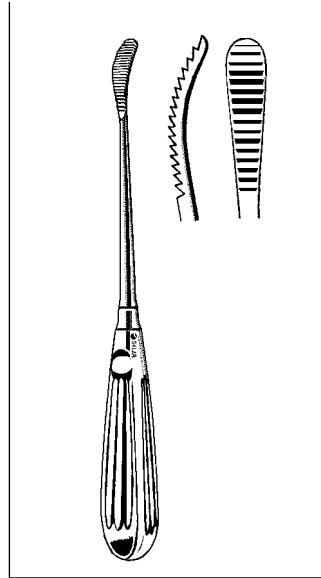
5 3/4" With Guarded Tip

41-1366	5 mm
41-1367	7 mm
41-1368	8 mm



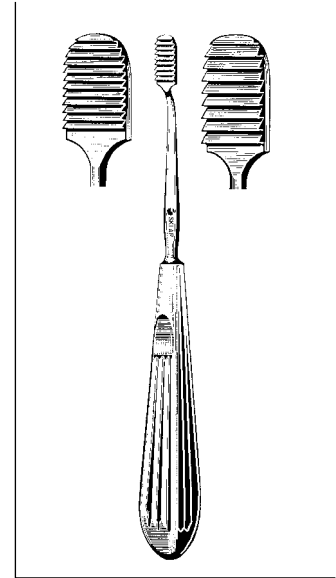
FREER CHISEL

41-1330 6½" Straight 4 mm
41-1332 6½" Curved 4 mm



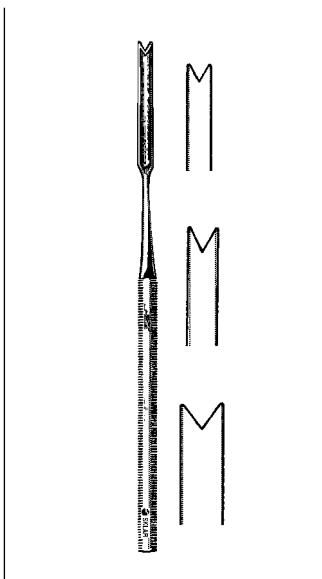
AUFRICHT GLABELLAR RASPS

40-9840 8" Forward cutting
40-9841 8" Backward cutting



LEWIS NASAL RASP

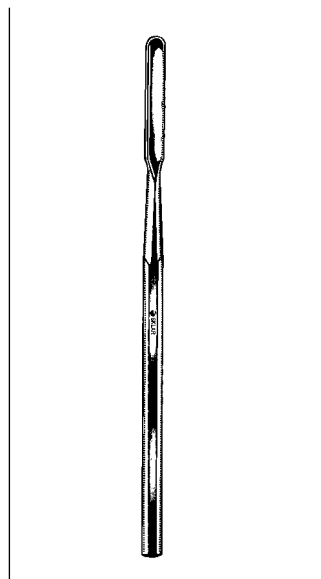
70-2292 7" Fine
70-2293 7" Coarse



HAJEK SEPTUM CHISELS

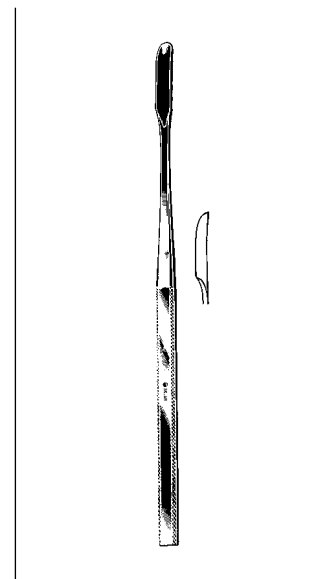
6" V-Shaped cutting edge
enhanced forward cutting effect

41-1361 4 mm Small
41-1362 6 mm Medium
41-1363 8 mm Large



FREER SEPTUM GOUGE

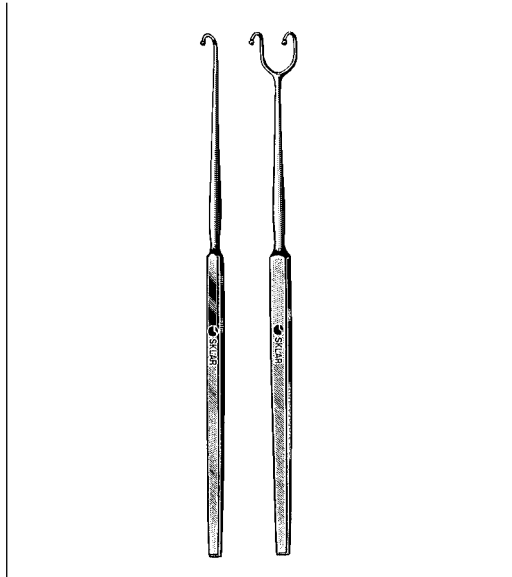
6 mm
41-1335 6½" Straight



WEST BONE GOUGE

41-1338 7½"

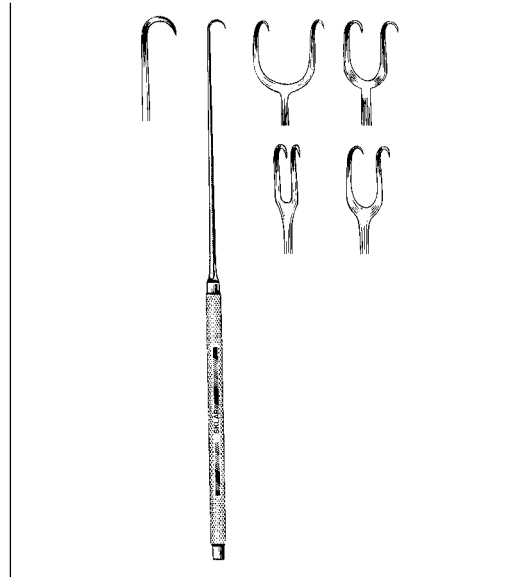
NASAL PLASTIC INSTRUMENTS



FOMON RETRACTOR

Ball End

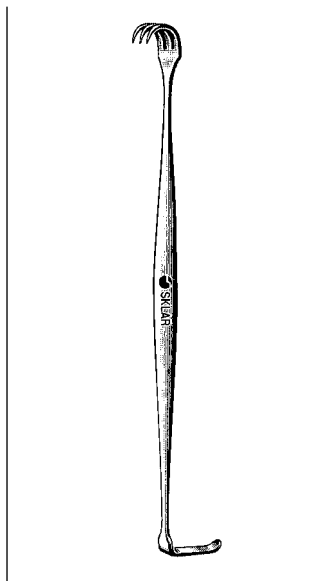
- 41-1395 6 1/4" Single
- 41-1396 6 1/4" Double



JOSEPH SKIN HOOK

Single End

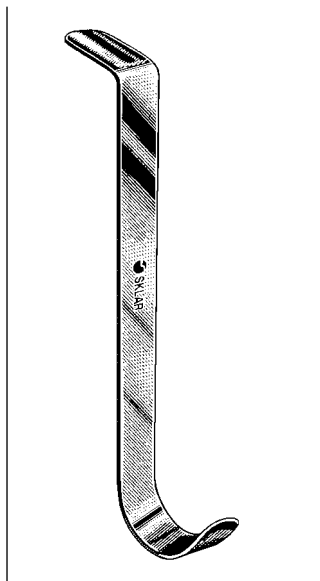
- 47-2500 6 1/4" 1 Sharp Prong
- 47-2502 6 1/4" 2 Prong 2 mm
- 47-2505 6 1/4" 2 Prong 5 mm
- 47-2507 6 1/4" 2 Prong 7 mm
- 47-2510 6 1/4" 2 Prong 10 mm



MILLER-SENN RETRACTOR

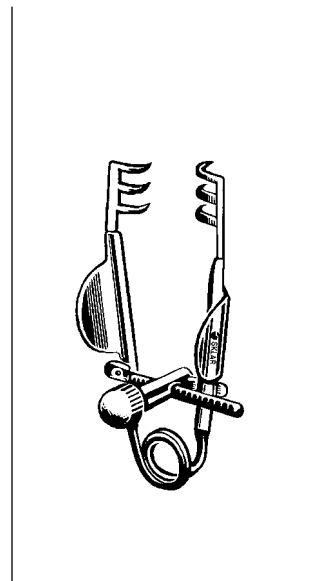
Double End

- 22-8360 6" Sharp
- 22-8460 6" Blunt



CONVERSE RETRACTOR

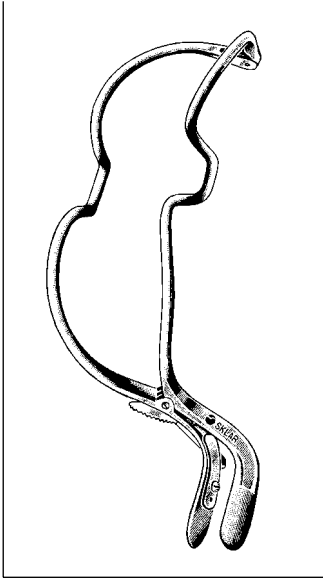
- 41-1402 3 3/4" #2 12 mm x 25 mm
- 41-1403 3 3/4" #3 12 mm x 40 mm



SELF RETRACTING RETRACTOR

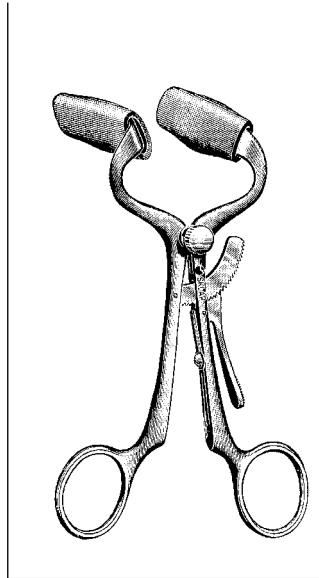
Delicate

- 65-1815 3 Sharp Prongs 1 1/2"



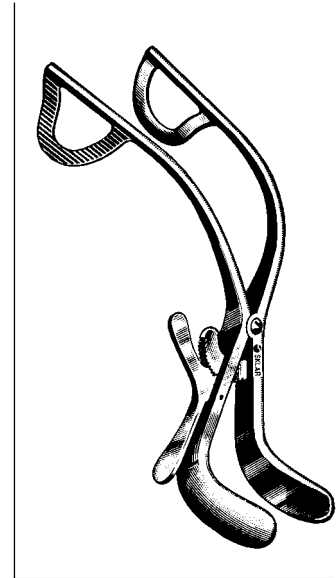
JENNINGS MOUTH GAG

Tru-Grip Ratchet
 75-1015 Small
 75-1016 Medium
 75-1017 Large



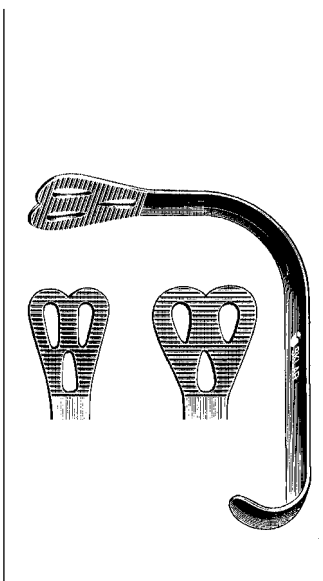
DOYEN-JANSEN MOUTH GAG

Tru-Grip Ratchet
 75-1025 With Rubber Sleeves
 75-1026 Rubber Sleeves Only
 22-8945 Pediatric-Complete



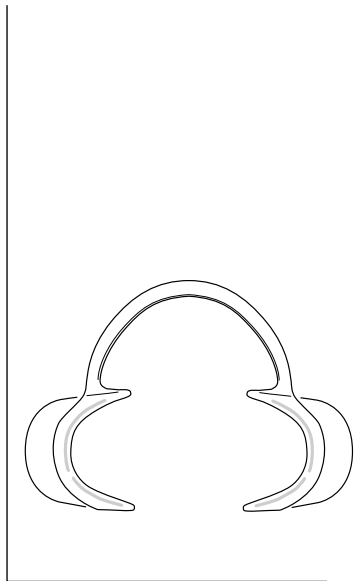
WESSON MOUTH GAG

Tru-Grip Ratchet
 75-1010 With Finger Guard



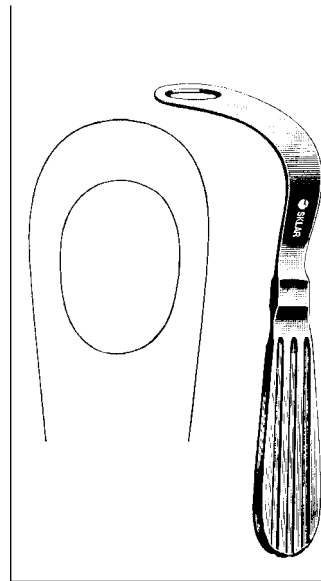
WIEDER TONGUE DEPRESSOR

Fenestrated and Serrated Blade
 75-2160 Small
 75-2161 Large



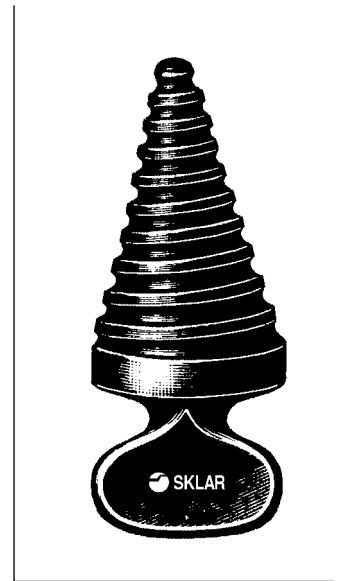
SKLAR CHEEK RETRACTOR

Clear Plastic
 75-1140 Set of 2 Adult
 75-1141 Set of 2 Child



BOSWORTH TONGUE DEPRESSOR

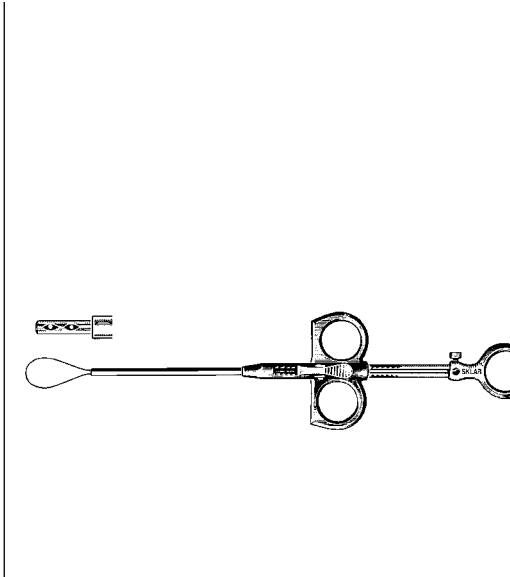
75-2175



ORAL SCREW, PLASTIC

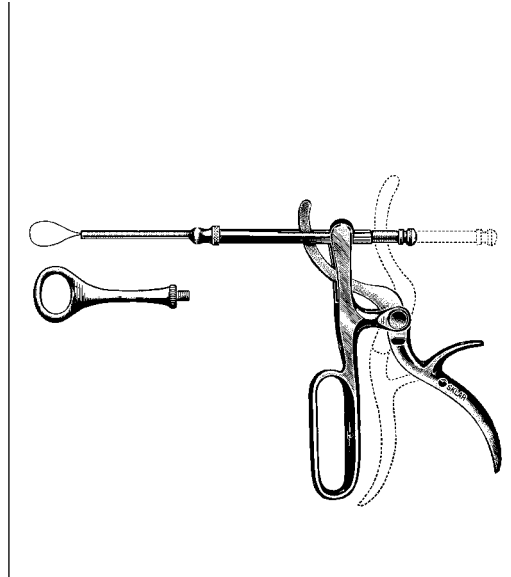
Mouth Opener
 75-1400

MOUTH & THROAT INSTRUMENTS



EVES TONSIL SNARE

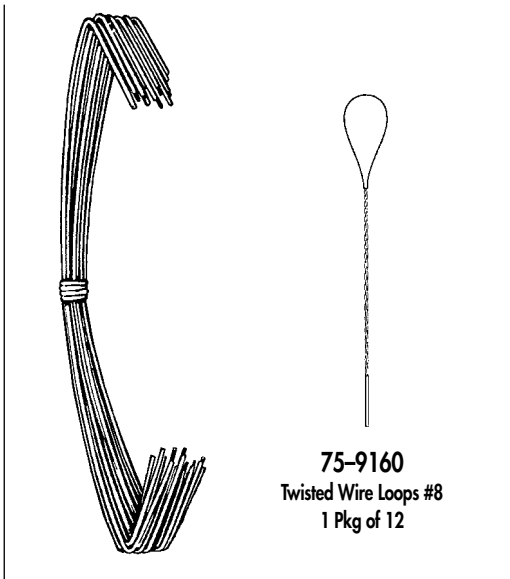
75-9070 Plain
75-9075 With Ratchet



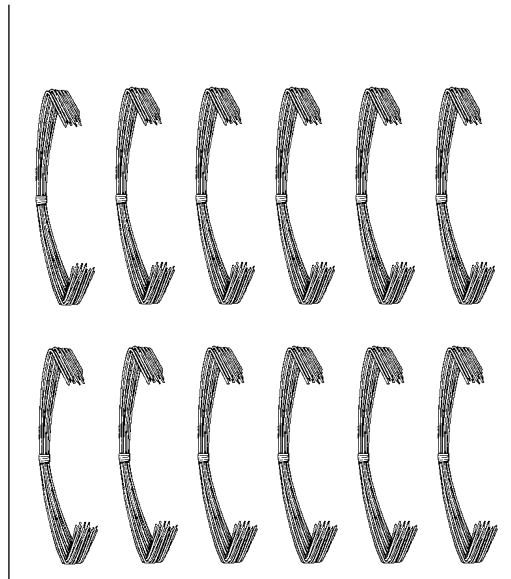
TYDING TONSIL SNARE

Complete

75-9245	Includes One Straight Tip, One Vedder Tip, One Dozen Cut Snare Wires	75-9226	Vedder Tip Only
		75-9227	Straight Tip Only
		75-9251	Stylet Complete
75-9250	Includes One Straight Tip Only, One Dozen Cut Snare Wires	75-9155	Twisted Wire Loops 5 1/2" #8 Dz.
		75-9160	Twisted Wire Loops 6" #8 Dz.



75-9160
Twisted Wire Loops #8
1 Pkg of 12



SNARE WIRES CUT & BENT

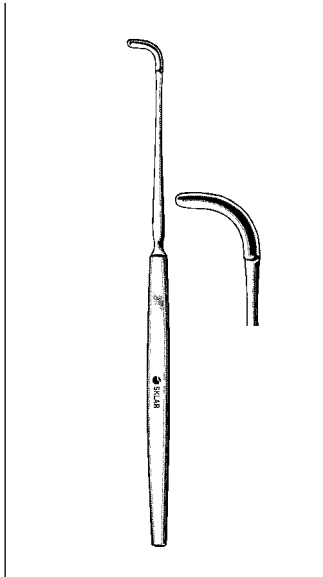
1 Package of 12 (12 Wires)

67-1753	#4	3" Long	75-9507	#7	4" Long
75-9505	#5	4" Long	75-9508	#8	4" Long
75-9506	#6	4" Long	75-9509	#9	4" Long

SNARE WIRES CUT & BENT

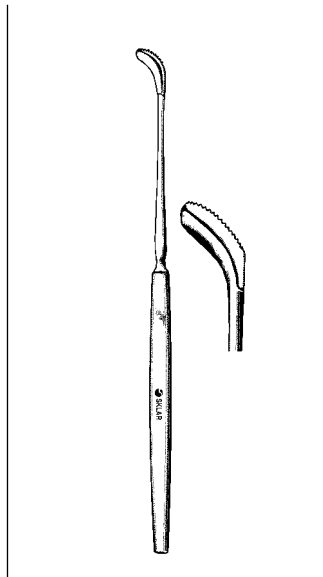
12 Package of 12 (144 Wires)

67-1752	#4	3" Long
75-9405	#5	4" Long
75-9406	#6	4" Long
75-9407	#7	4" Long
75-9408	#8	4" Long
75-9409	#9	4" Long



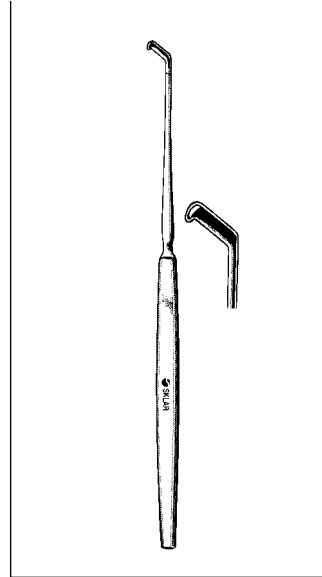
TYDING TONSIL KNIFE

75-7482 8½"



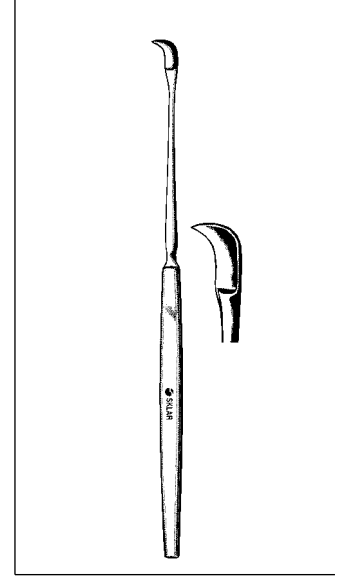
FISHER TONSIL KNIFE

75-7590 8½"



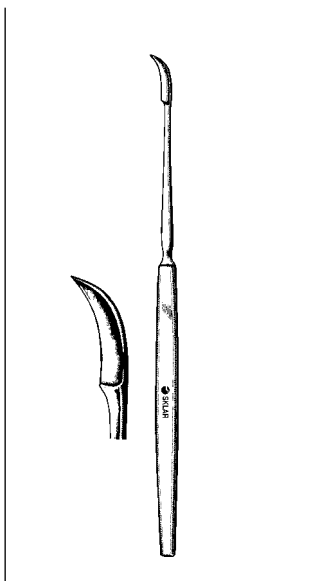
**DOUGLASS TONSIL
KNIFE**

75-7282 8¼" Angled



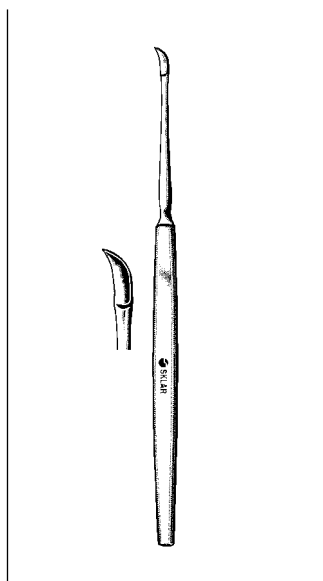
**CANFIELD TONSIL
KNIFE**

75-7080 8½"



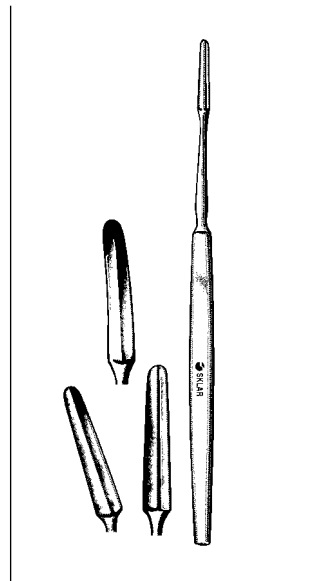
**ABRAHAM TONSIL
KNIFE**

75-7382 8¾"



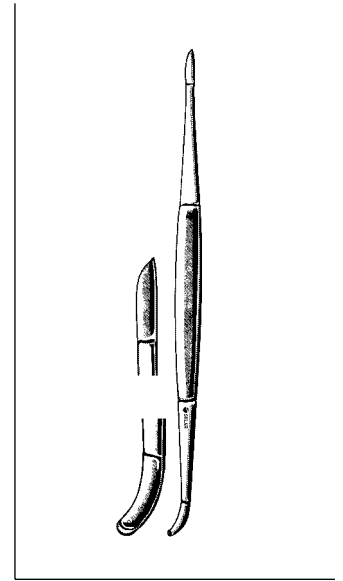
ATKINS TONSIL KNIFE

75-7077 7½"



DEAN TONSIL KNIVES

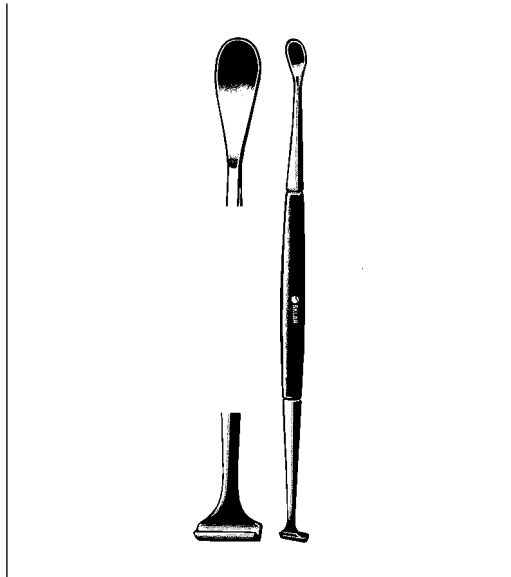
75-7490 7¼" Slight Curve
75-7491 7¼" Angular
75-7492 7¼" Straight



**LOTHROP TONSIL
KNIFE**

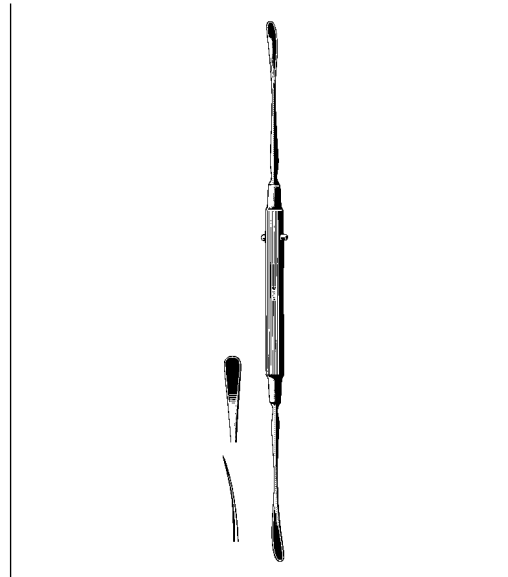
75-7575 8"

MOUTH & THROAT INSTRUMENTS



HURD TONSIL DISSECTOR AND PILLAR RETRATOR

75-6387 8 3/4"



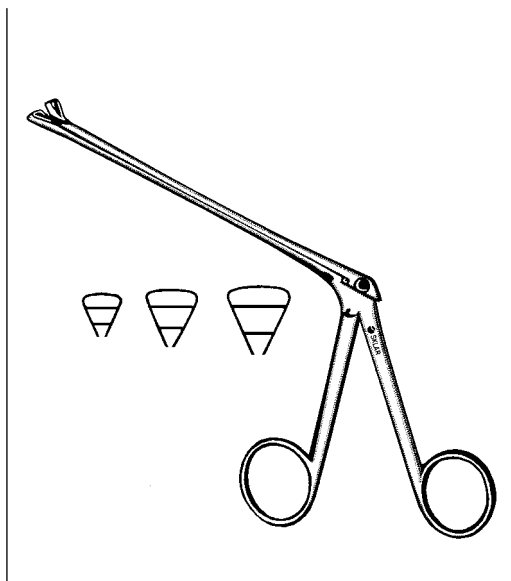
FREER ELEVATORS

Double Ended with Blunt/Sharp Blades

47-2380 7" 5 mm wide

47-2382 7 1/4" 4.5 mm wide

47-2384 7 3/4" 6.5 mm wide



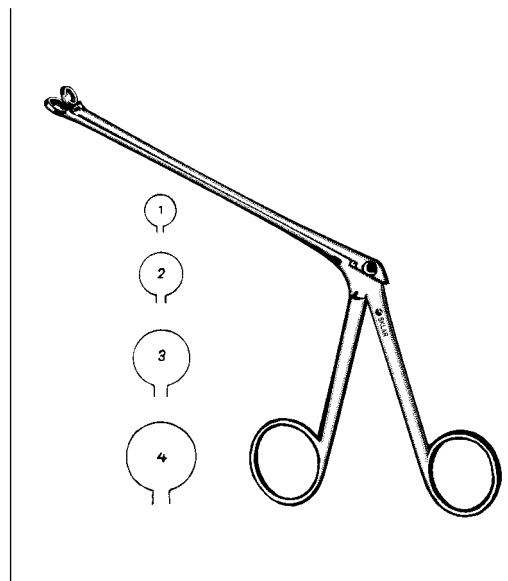
SCHMEDEN TONSIL PUNCHES

5 1/2" shank with triangular basket tip

75-9601 Size 1

75-9602 Size 2

75-9603 Size 3



HARTMAN (MOSHER) TONSIL PUNCHES

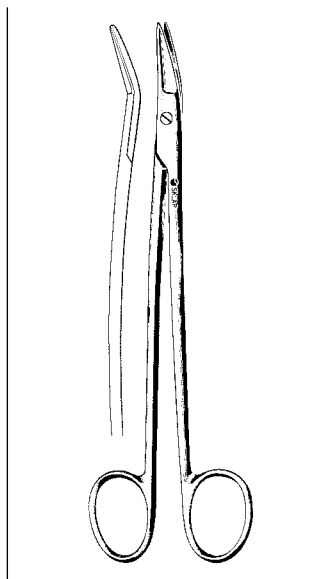
5 1/2" shank with round basket tip

75-9611 Size 1

75-9612 Size 2

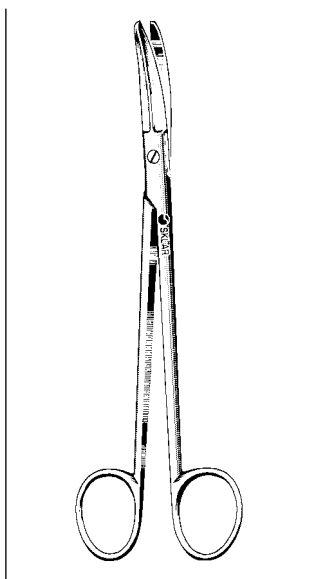
75-9613 Size 3

75-9614 Size 4



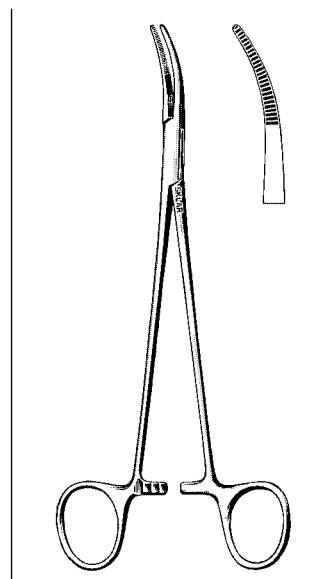
DEAN TONSIL SCISSORS

Angular Blade
75-5267 6½" Serrated



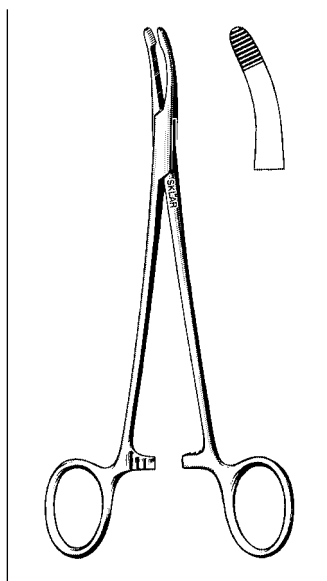
BOETTCHER TONSIL SCISSORS

75-5070 7" Curved



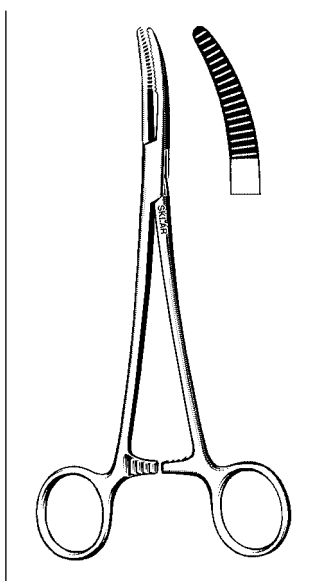
SCHNIDT TONSIL FORCEPS

74-3075 7½" Half Curved



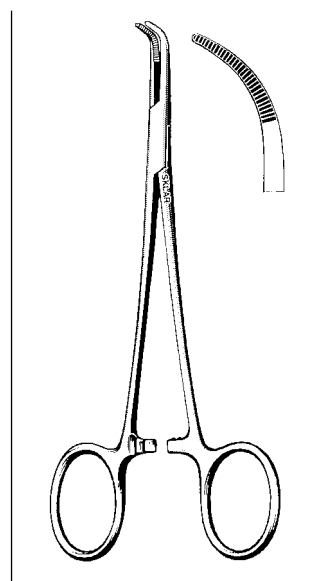
DAVIS FORCEPS

74-3070 7" Curved



KELLY FORCEPS

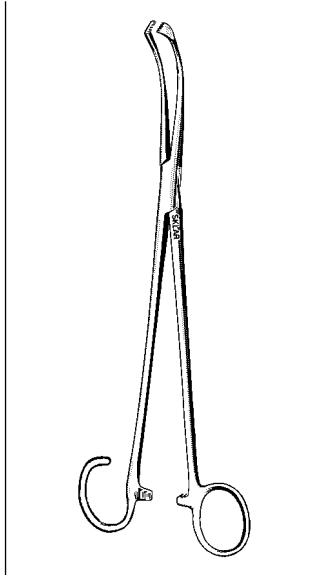
74-3270 7" Curved Extra Heavy



SAWTELL TONSIL FORCEPS

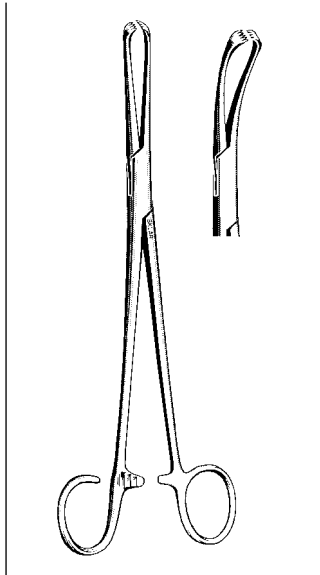
74-3175 7½" Full Curved

MOUTH & THROAT INSTRUMENTS



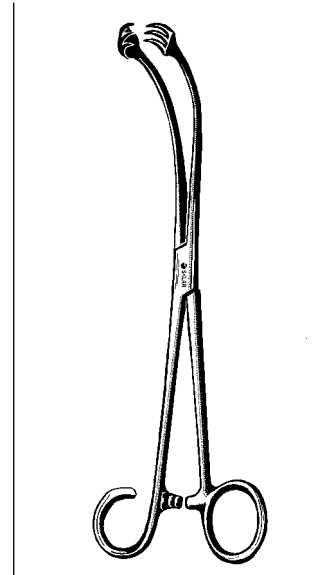
WHITE TONSIL FORCEPS

One Open Ring
 74-2575 7½" Curved
 74-2590 9" Curved



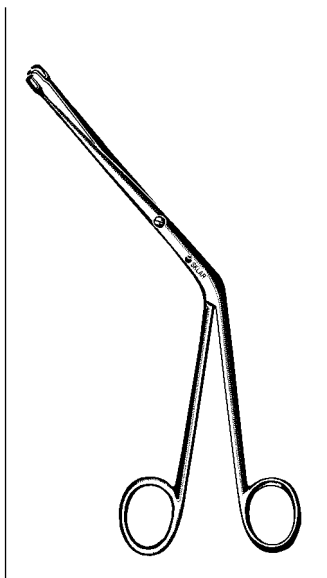
COLVER-COAKLEY TONSIL FORCEPS

74-2475 7½" Curved



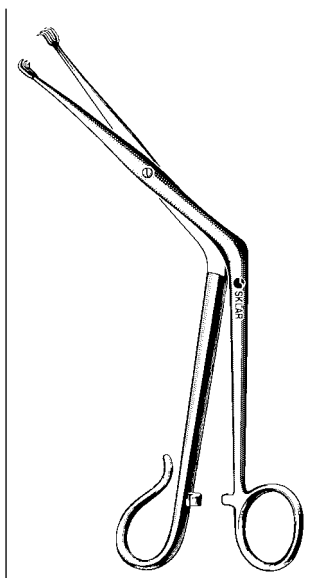
BALLENGER TONSIL SEIZING FORCEPS

74-1185 8½" (21.6 cm)
 One with open ring



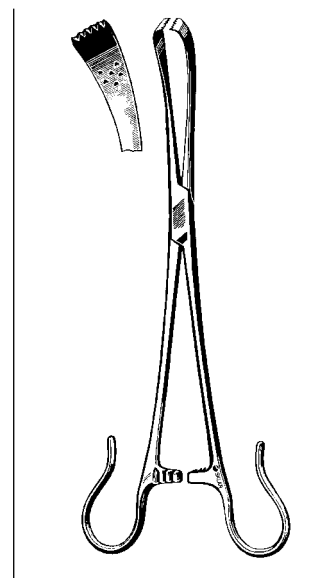
TYDING TONSIL SEIZING FORCEPS

74-1975 7½" Angular with catch
 Fine 2 x 2 Prongs



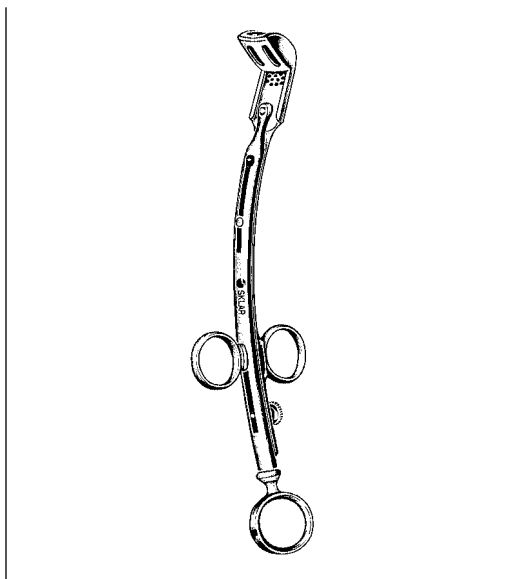
TIVNEN TONSIL SEIZING FORCEPS

74-2175 7½" 3 x 3 Angular



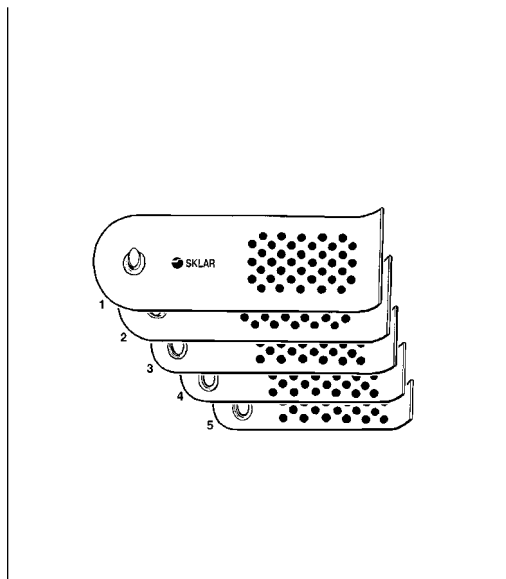
CRAIG TONSIL SEIZING FORCEPS

74-1280 8"



LA FORCE ADENOTOME

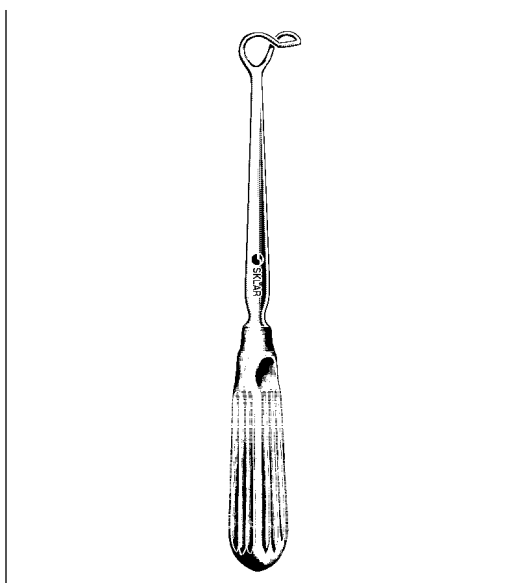
- 70-9001 No. 1 Large Size
- 70-9002 No. 2 Medium
- 70-9003 No. 3 Small
- 70-9004 No. 4 Extra Small
- 70-9005 No. 5 Infant



LA FORCE ADENOTOME

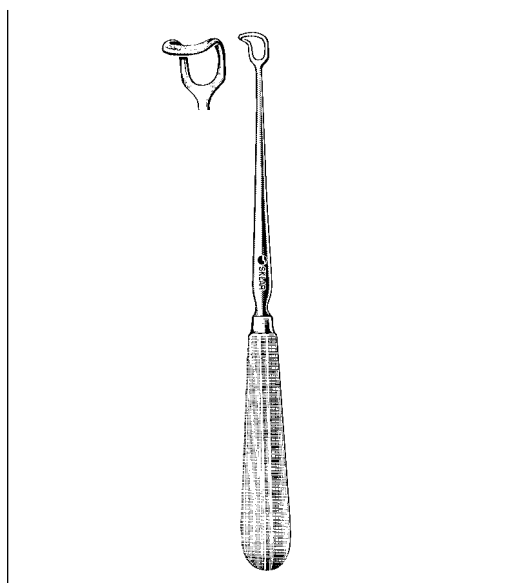
Blades Only

- 70-9101 No. 1 Large Size
- 70-9102 No. 2 Medium
- 70-9103 No. 3 Small
- 70-9104 No. 4 Extra Small
- 70-9105 No. 5 Infant



BARNHILL ADENOID CURETTE

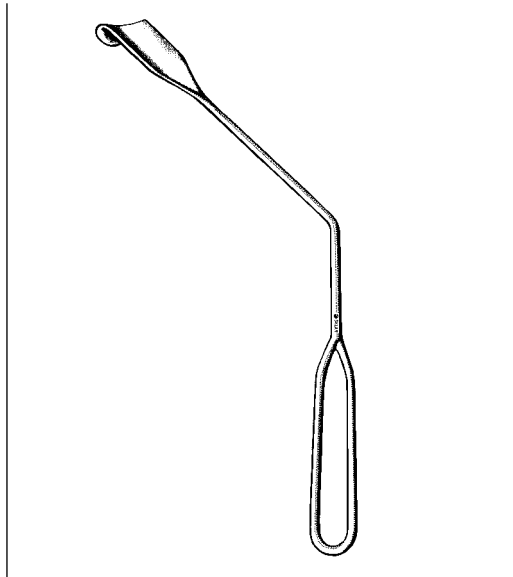
- 70-9200 No. 0
- 70-9201 No. 1
- 70-9202 No. 2
- 70-9203 No. 3
- 70-9204 No. 4



VOGEL ADENOID CURETTE

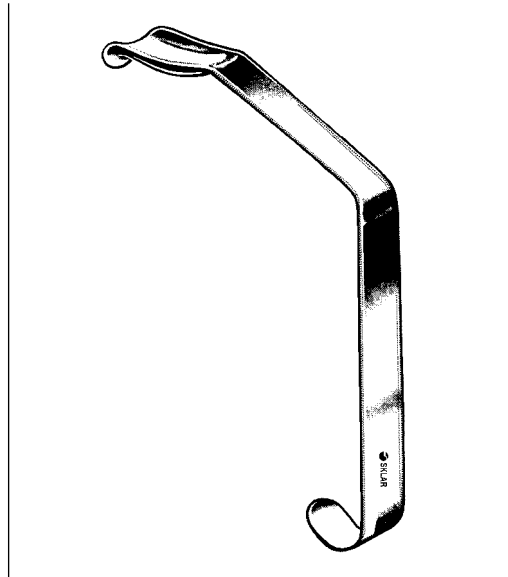
- 70-9210 Infant

MOUTH & THROAT INSTRUMENTS



LOTHROP UVULA RETRACTOR

75-2315 20 mm wide



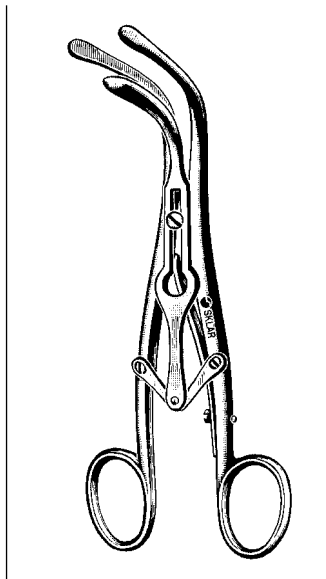
LOVE UVULA RETRACTORS

Lifts soft palate and allows for easy removal of adenoid tissue

75-2318 18 mm wide

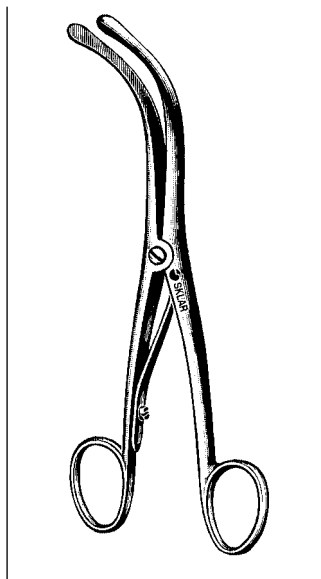
75-2320 20 mm wide

75-2322 22 mm wide



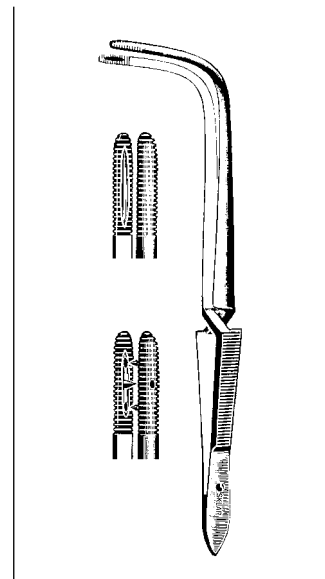
DELABORDE TRACHEAL DILATOR

3 Blade
78-3460 6"



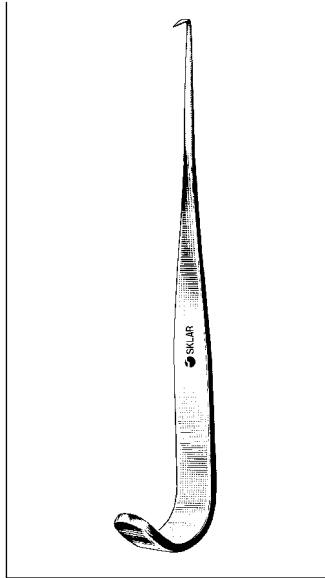
TROUSSEAU TRACHEAL DILATOR

2 Blade
78-3360 6"
22-9155 5½" Pediatric



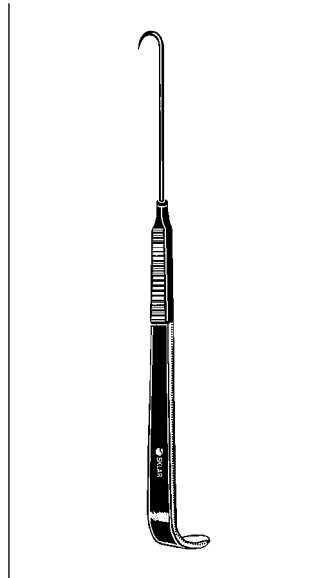
JACKSON X-ACTION FORCEPS

76-1390 9" Serrated
76-1490 9" With Teeth



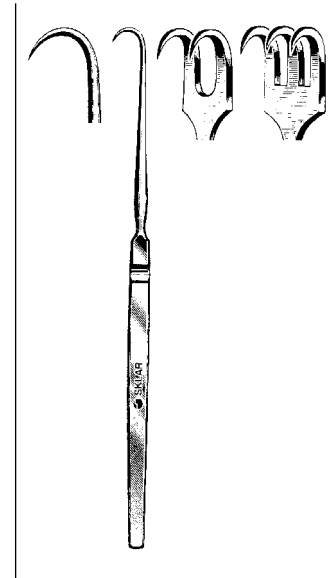
JACKSON TENACULUM

78-3550 5"



NEWS TRACHEAL HOOK

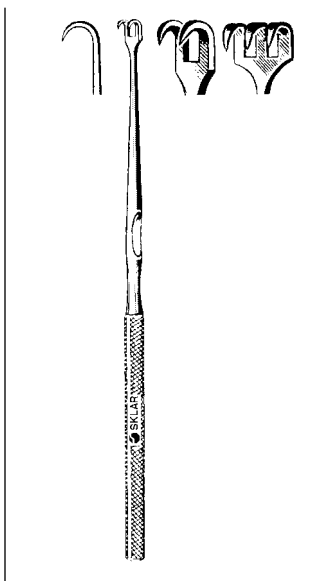
78-3545 6"



TRACHEAL RETRACTOR

6½"

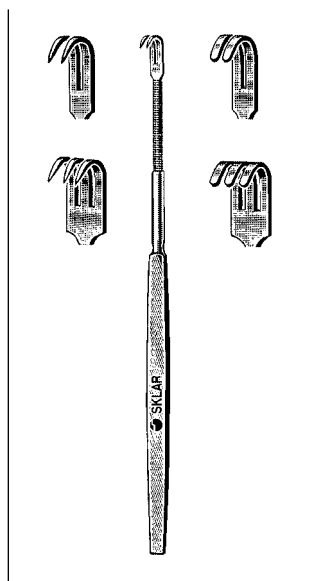
78-1001	Sharp	1 Prong
78-1002	Sharp	2 Prong
78-1003	Sharp	3 Prong
78-1101	Blunt	1 Prong
78-1102	Blunt	2 Prong
78-1103	Blunt	3 Prong



LAHEY RETRACTOR

4¾" Sharp

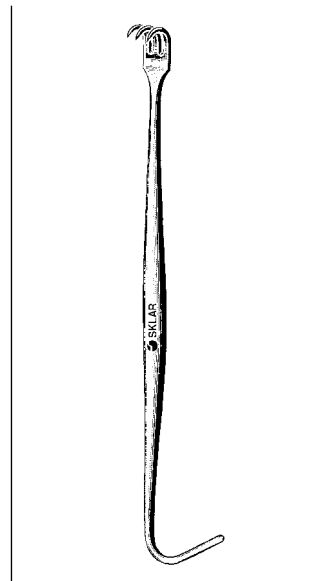
78-1201	1 Prong
78-1202	2 Prong
78-1203	3 Prong



TRACHEAL RETRACTORS

6" Flexible Shank

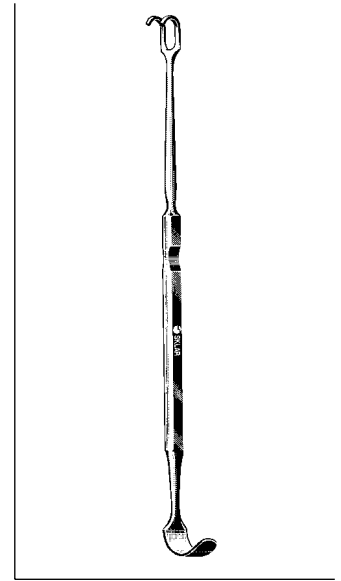
22-9132	Sharp	2 Prong
22-9133	Sharp	3 Prong
22-9142	Blunt	2 Prong
22-9143	Blunt	3 Prong



HUPP TRACHEAL RETRACTOR

Double End

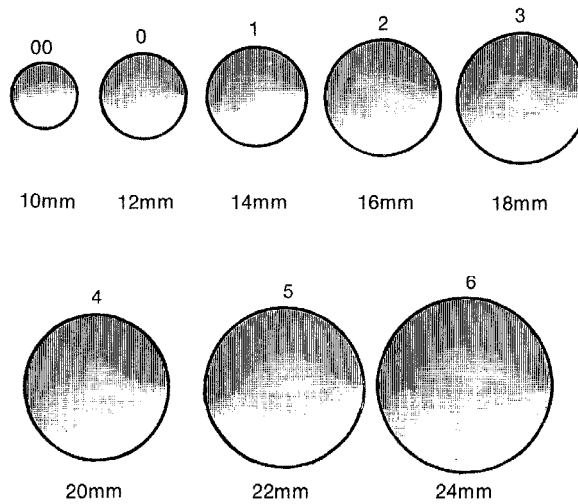
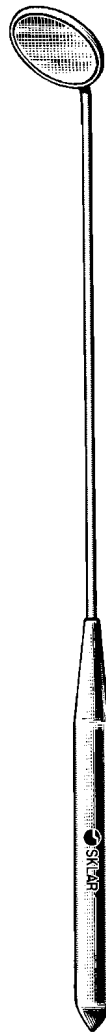
78-1113 6" with 3 sharp prongs and blunt hook



JACKSON TRACHEAL RETRACTOR

Blunt Double Prong

78-3570 7"

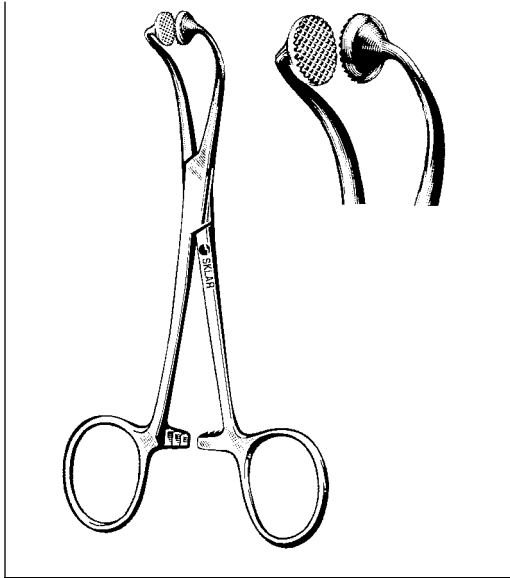


LARYNGEAL MIRROR REGULAR BOILABLE

Chrome With Handles		Stainless Steel Handles	
73-1189	#00	73-1179	#00
73-1190	#0	73-1180	#0
73-1191	#1	73-1181	#1
73-1192	#2	73-1182	#2
73-1193	#3	73-1183	#3
73-1194	#4	73-1184	#4
73-1195	#5	73-1185	#5
73-1196	#6	73-1186	#6

LARYNGEAL MIRROR EVERCLEAR BOILABLE-REMAINS CLEAR AFTER HEATING

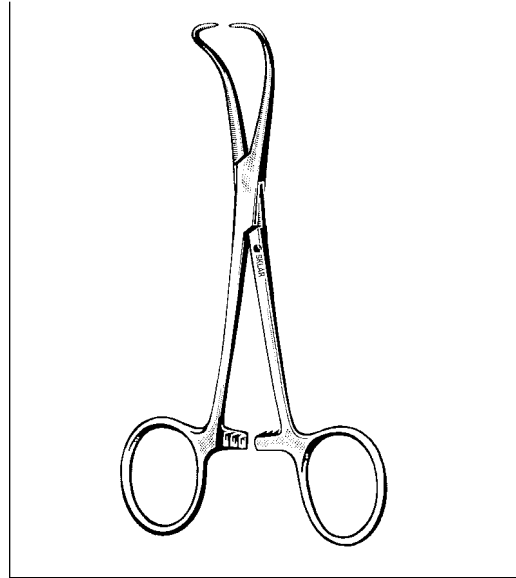
Chrome With Handles		Stainless Steel Handles	
73-1351	#1	73-1341	#1
73-1352	#2	73-1342	#2
73-1353	#3	73-1343	#3
73-1354	#4	73-1344	#4
73-1355	#5	73-1345	#5
73-1356	#6	73-1346	#6



HOFF TOWEL CLAMP

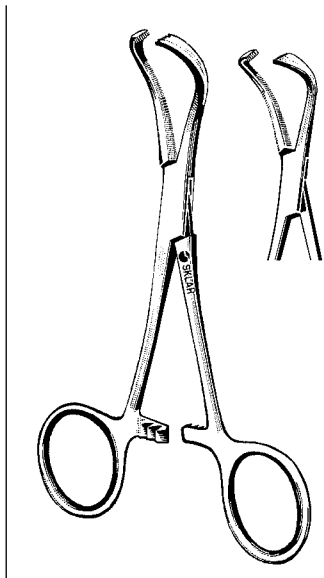
Stainless Steel
 47-3040 4"
 47-3057 5 1/2"

Serrated disc jaws effectively clamp—but will not tear or penetrate cloth or disposable drapes and towels. Can be removed and reapplied without contamination of the field. Also useful to secure cords and tubings to drapes.



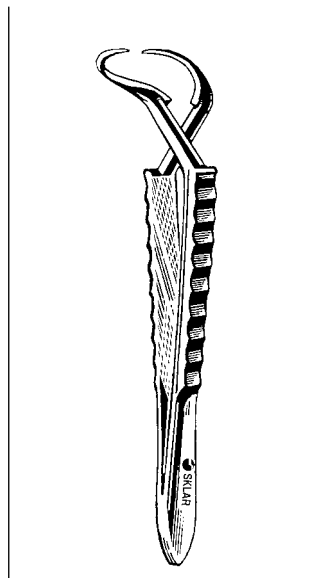
BACKHAUS TOWEL CLAMP

47-2935 3 1/2"
 47-2955 5 1/4"



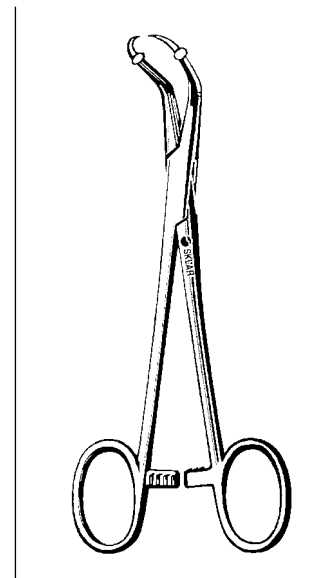
LORNA (EDNA) TOWEL CLAMP

Non-Perforating
 47-2837 4"
 47-2852 5 1/4"



JONES CROSS ACTION TOWEL CLAMP

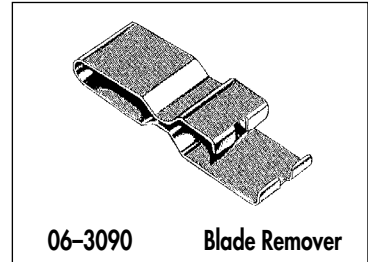
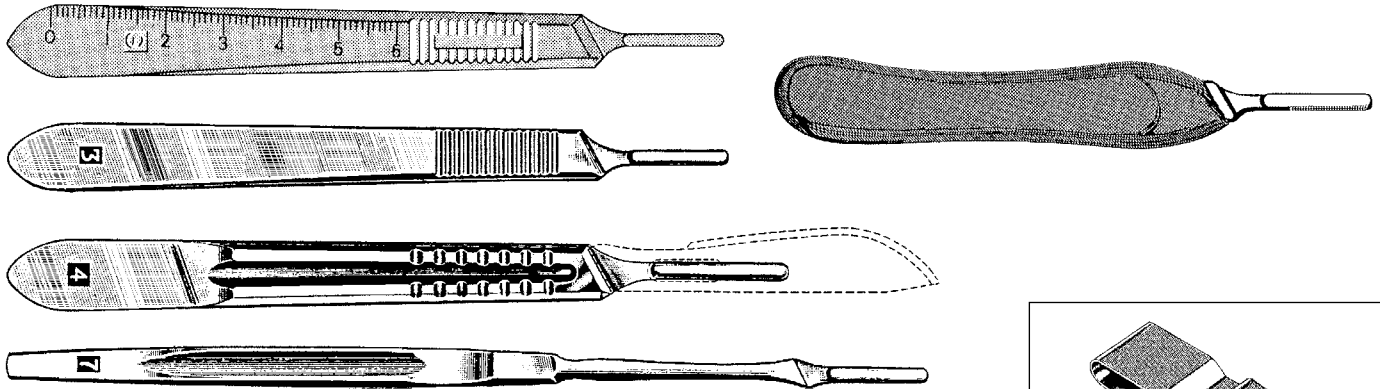
47-2925 2 1/2" Delicate
 47-2930 3 1/2"



ROEDER TOWEL CLAMP

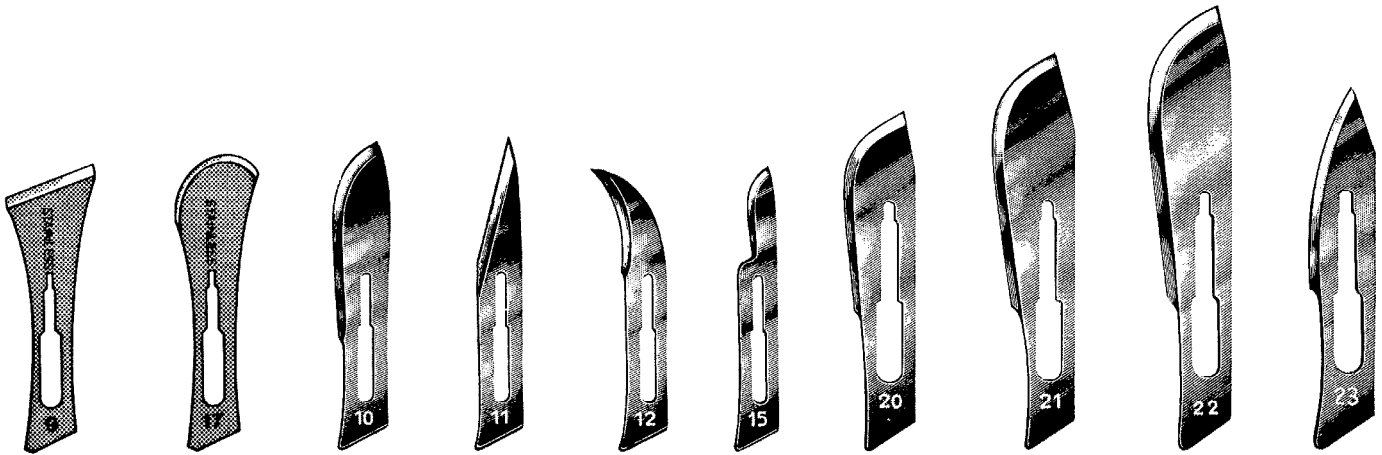
87-1052 5 1/4" With Ball Stops

SCALPELS



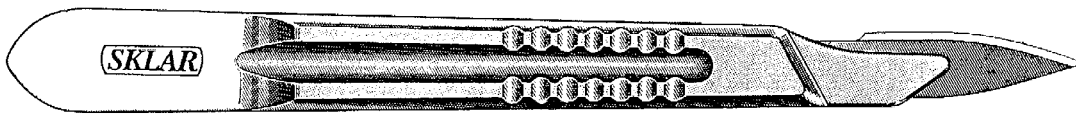
SCALPEL HANDLES

- | | | | |
|---------|--|---------|--------------------------|
| 06-2910 | Scalpel Handle #3 w/metric scale | 06-2915 | Scalpel Handle #3L |
| 06-2903 | Scalpel Handle #3 fits Blade #10, 11, 12, 15 | 06-2920 | Scalpel Handle #4L |
| 06-2904 | Scalpel Handle #4 fits Blade #20, 21, 22, 23 | 06-2925 | Large Lab Type Handle #3 |
| 06-2907 | Scalpel Handle #7 fits Blade #10, 11, 12, 15 | 06-2930 | Large Lab Type Handle #4 |



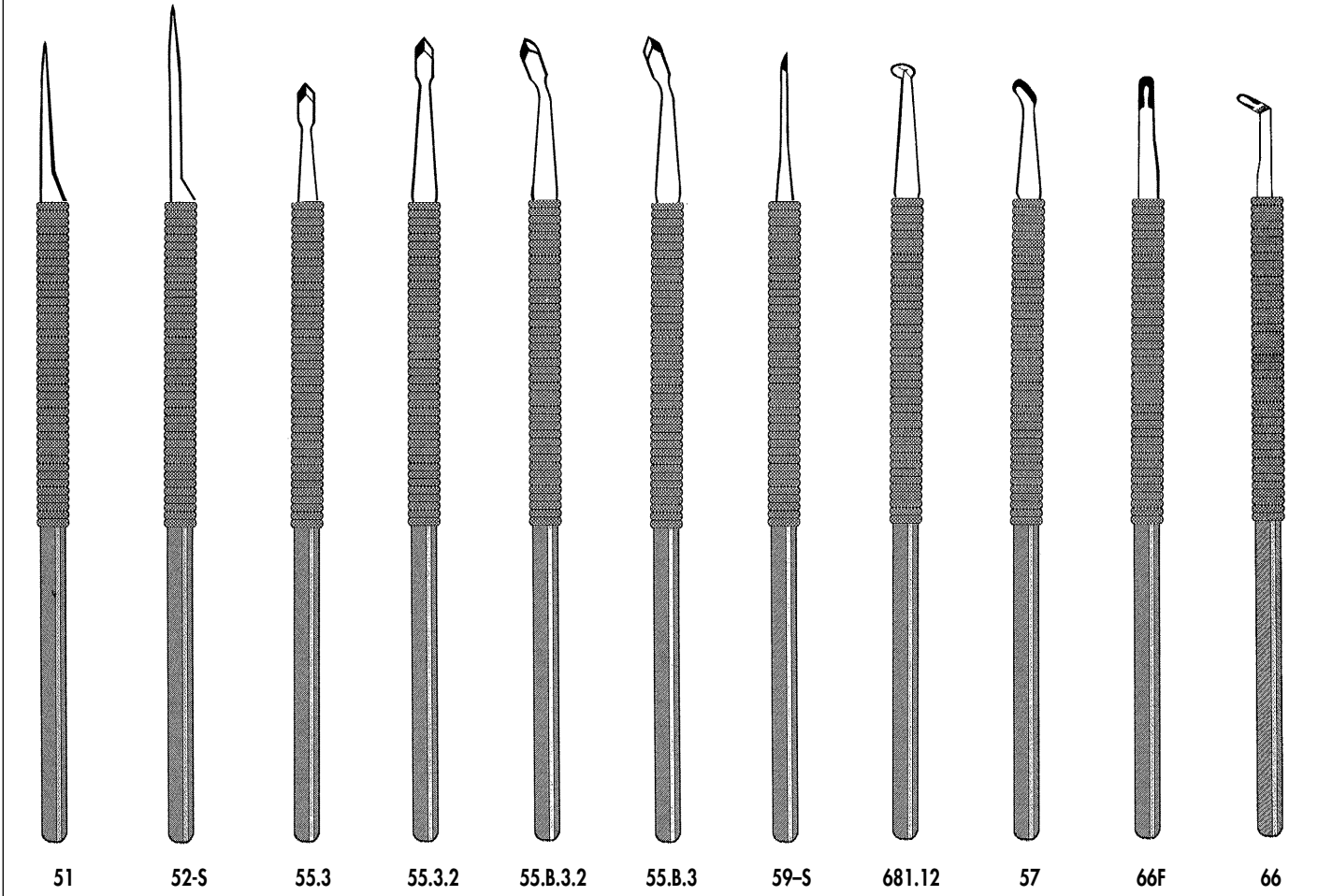
SURGICAL BLADES

- | | | | |
|-------------------------|-------------|---------------------|-------------|
| Non-Sterile Pack of 100 | | Sterile Pack of 100 | |
| 06-3045 #9 | 06-3056 #15 | 06-3100 #10 | 06-3104 #20 |
| 06-3048 #17 | 06-3058 #20 | 06-3101 #11 | 06-3105 #21 |
| 06-3050 #10 | 06-3060 #21 | 06-3102 #12 | 06-3106 #22 |
| 06-3052 #11 | 06-3062 #22 | 06-3103 #15 | 06-3107 #23 |
| 06-3054 #12 | 06-3064 #23 | | |



STERILE DISPOSABLE SCALPEL COMPLETE Pack of 10

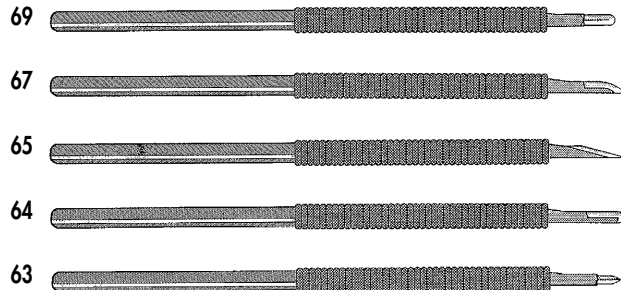
- | | | | |
|-------------|-------------|-------------|-------------|
| 06-3110 #10 | 06-3112 #12 | 06-3120 #20 | 06-3122 #22 |
| 06-3111 #11 | 06-3115 #15 | 06-3121 #21 | 06-3123 #23 |



HANDLES PERMANENTLY ATTACHED

Sterile – Stainless Steel, Pack of 6

- | | | | | | |
|---------|-----------------------------|-----------|---------|----------------------------|---------|
| 06-2950 | Extra Delicate Blade | #51 | 06-2975 | Angular Chisel Point Blade | #55.B.3 |
| 06-2955 | Delicate Blade | #52-S | 06-2980 | Needle Blade 3 mm | #59-S |
| 06-2960 | Straight Chisel Point Blade | #55.3 | 06-2985 | Round Blade 60° Angle | #681.21 |
| 06-2965 | Straight Chisel Point Blade | #55.3.2 | 06-2990 | Angular Blade 45° Angle | #57 |
| 06-2970 | Angular Chisel Point Blade | #55.B.3.2 | 06-2992 | Straight Cutting Forward | #66-F |
| | | | 06-2995 | Angular Blade 60° Angle | #66 |



MINIATURE EDGED BLADES WITH HANDLES

Sterile – With Handles, Pack of 6

- 06-3086 #69
- 06-3085 #67
- 06-3084 #65
- 06-3083 #64
- 06-3082 #63

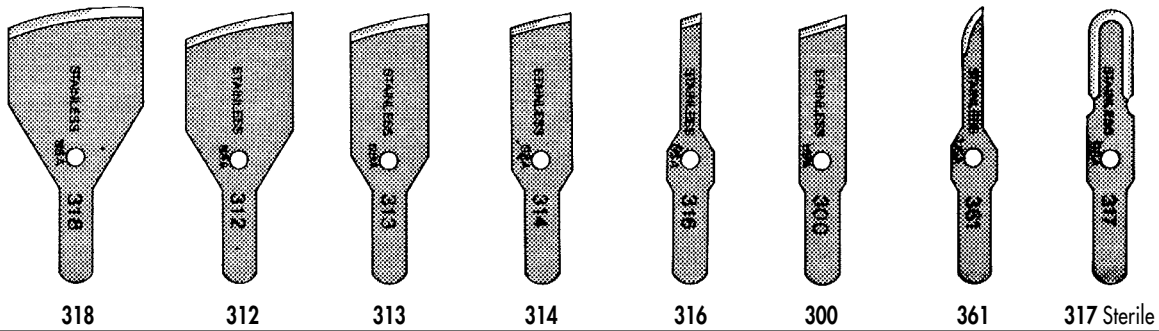


DISPOSABLE MINIATURE EAR KNIVES

Sterile 12 Per Pack

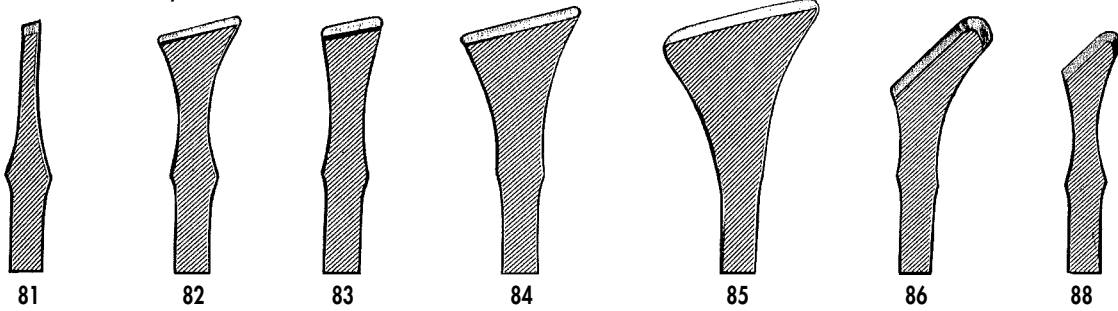
- | | | |
|---------|--------------------|-----------------|
| 67-2020 | Ear Knife Angled | Broad Tip 71 |
| 67-2022 | Ear Knife Angled | Narrow Tip 71-N |
| 67-2024 | Ear Knife Straight | Spear Tip 71-S |

SCALPELS



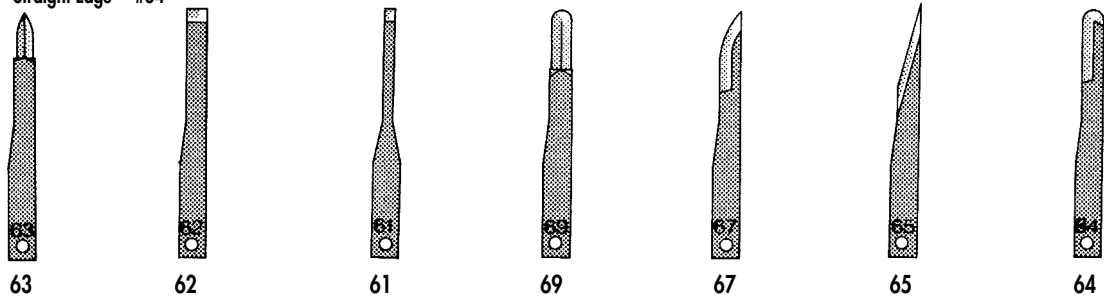
SPECIALTY BLADES- Non-Sterile Box of 12

- | | | | | | |
|---------|-------------|-------|---------|---------------|-------------------|
| 97-1400 | Curved Edge | # 318 | 97-1420 | Straight Edge | #316 |
| 97-1405 | Curved Edge | #312 | 97-1425 | Straight Edge | #300 |
| 97-1410 | Curved Edge | #313 | 97-1430 | Knife Edge | #361 |
| 97-1415 | Curved Edge | #314 | 97-1435 | Round End Cut | #317 Sterile Only |
- (Box of 5) #314 Only



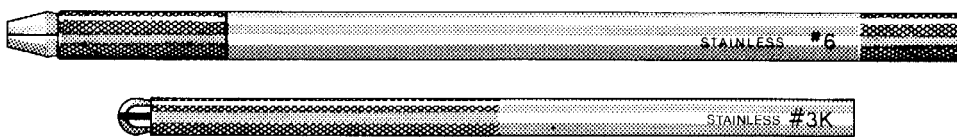
SPECIALTY BLADES - Non-Sterile, Box of 5

- | | | | | | |
|---------|---------------|-----|---------|---------------|-----|
| 97-1700 | Straight Edge | #81 | 97-1704 | Straight Edge | #85 |
| 97-1701 | Straight Edge | #82 | 97-1705 | Angled Edge | #86 |
| 97-1702 | Straight Edge | #83 | 97-1706 | Angled Edge | #88 |
| 97-1703 | Straight Edge | #84 | | | |



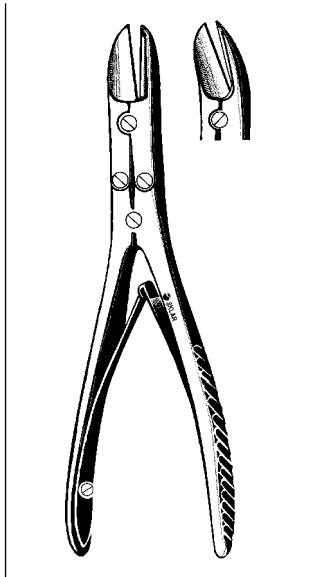
MINIATURE EDGE BLADES- Sterile Box of 12

- | | | | | | | | | |
|---------|----------------------|-----|---------|----------------------|-----|---------|----------------------|-----|
| 97-1720 | Miniature Edge Blade | #63 | 97-1723 | Miniature Edge Blade | #69 | 97-1725 | Miniature Edge Blade | #65 |
| 97-1721 | Miniature Edge Blade | #62 | 97-1724 | Miniature Edge Blade | #67 | 97-1726 | Miniature Edge Blade | #64 |
| 97-1722 | Miniature Edge Blade | #61 | | | | | | |



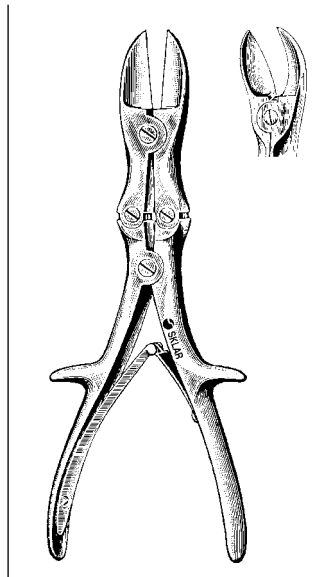
HANDLE FOR SPECIALTY BLADES Packed Individually Stainless Steel

- 97-1445 #6 Handle, Self Locking For Podiatry Blades
 97-1450 #3K Handle For Miniature Edge Blades



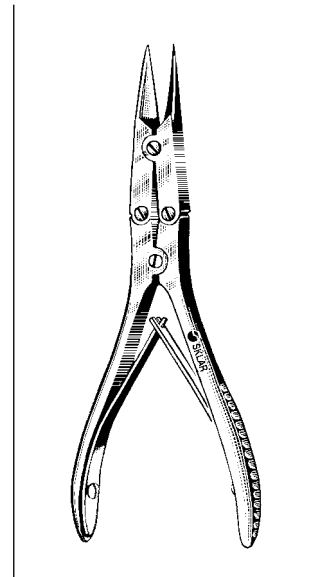
RUSKIN-LISTON BONE CUTTING FORCEPS

40-4572 7¼" Straight
40-4575 7¼" Up-Angled



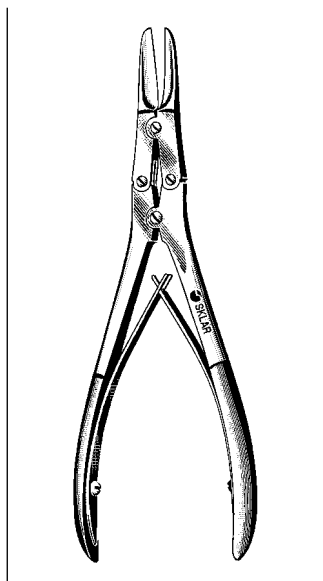
STILLE-LISTON RONGEUR

Double Action
40-3710 10½" Straight
40-3810 10½" Curved



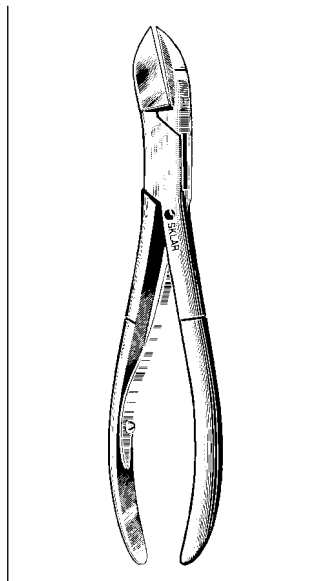
RUSKIN-LISTON

Double Action
40-4560 6" Straight
40-4562 6" Delicate
40-4564 6" Angular



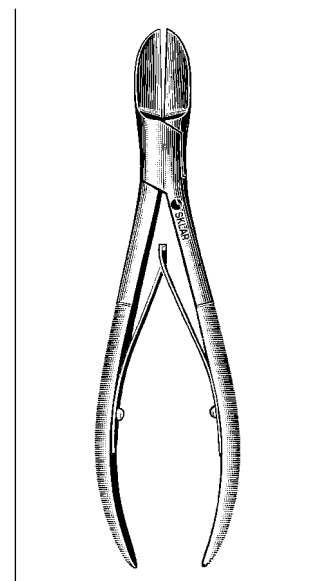
ROWLAND BONE FORCEPS

Double Action
41-1175 7" Narrow Jaws



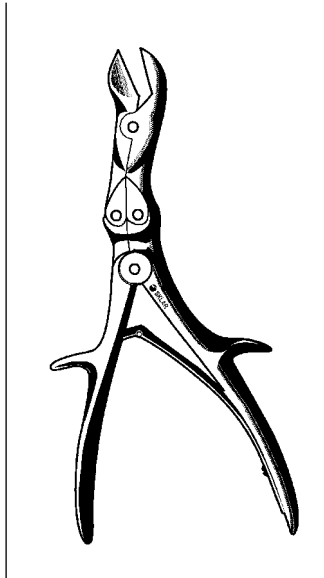
LISTON BONE FORCEPS

40-3155 5½" Angular
40-3177 7¾" Angular
40-3187 8¾" Angular



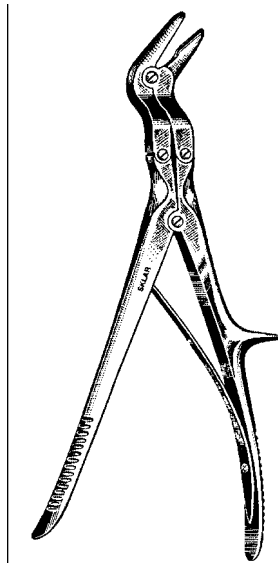
LISTON BONE FORCEPS

40-3055 5½" Straight
40-3077 7¾" Straight
40-3087 8¾" Straight



STILLE-HORSLEY BONE CUTTING FORCEPS

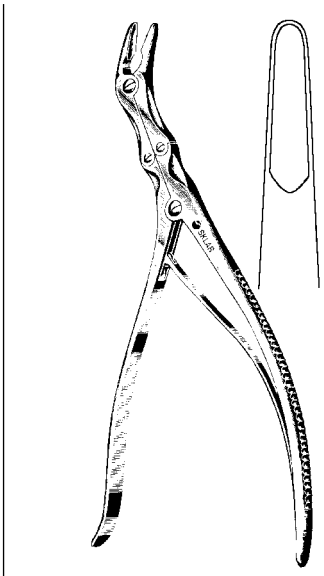
Bayonet, Multiple Action
40-3910 10½"



The Sklar Rongeur has been developed for cutting the intervertebral disc. Seen from above the jaws are slightly curved, seen from aside, the instrument is cranked to side. Due to its special shape the vision of the operating doctor remains clear, his hand remaining outside the operating field. This rongeur "double action" allows for precise and easy handling.

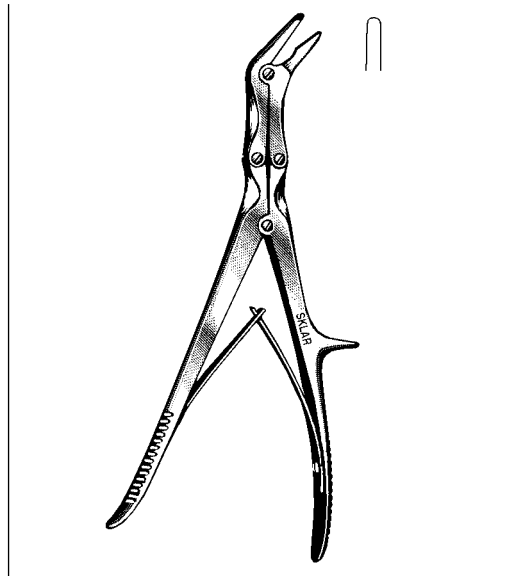
SKLAR DOUBLE ACTION RONGEUR

40-4106 8¾" Cranked Left
40-4108 8¾" Cranked Right



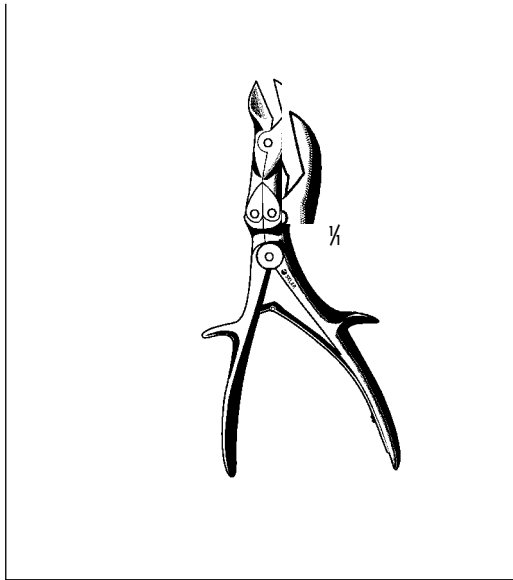
FRYKHOLM RONGEUR

40-4120 9"



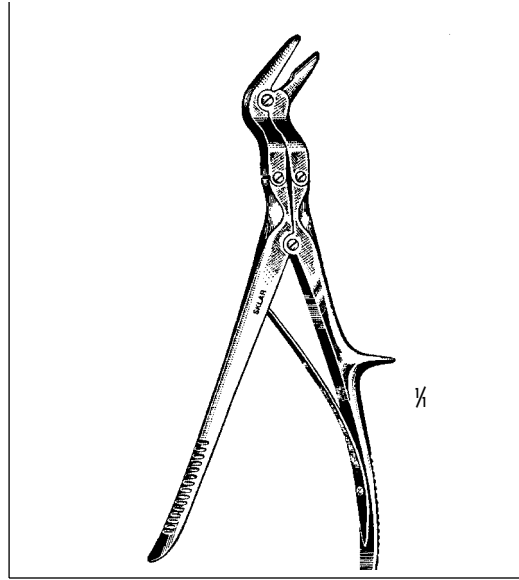
ECHLIN RONGEUR

Angular (Duckbill)
40-4100 9" 2 x 15 mm bite
40-4102 9" 3 x 15 mm bite
40-4104 9" 4 x 15 mm bite



STILLE RONGEUR

40-4086 9" 6 mm x 15 mm Jaw

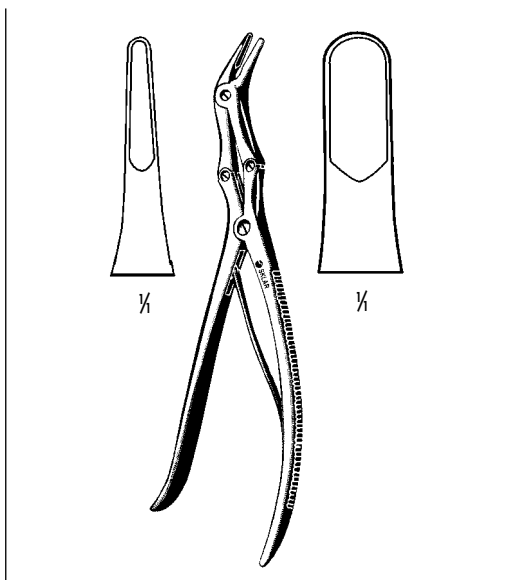


LEKSELL RONGEUR

Double Action

40-4092 9" Slightly Curved 8 mm

40-4095 9" Slightly Curved Narrow Jaws 3 mm

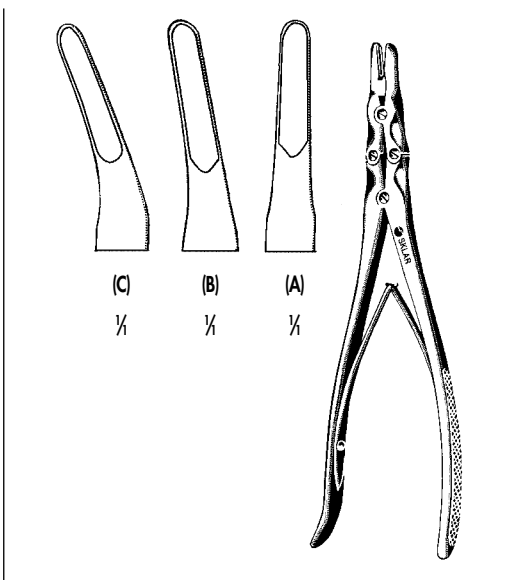


LEKSELL ANGULAR BITE RONGEUR

Double Action

40-4097 9" 3 mm

40-4098 9" 8 mm

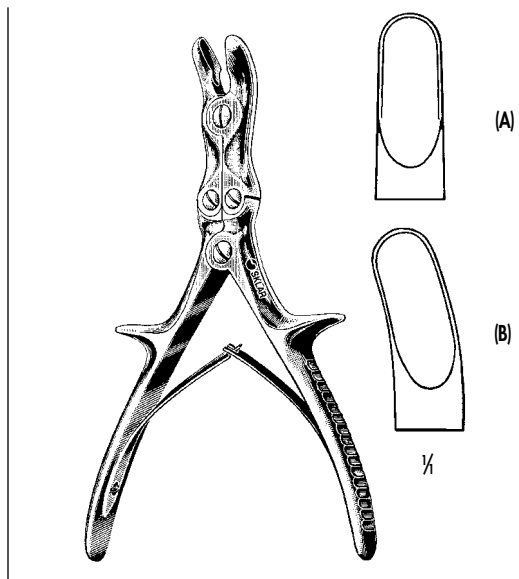


SMITH-PETERSEN LAMINECTOMY RONGEUR

40-4110 9 1/2" 3 mm Bite Straight (A)

40-4112 9 1/2" 3 mm Bite Half curved (B)

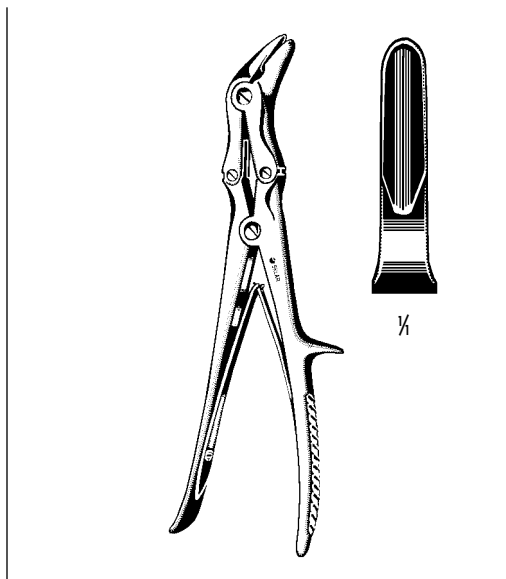
40-4114 9 1/2" 3 mm Bite Full Curved (C)



STILLE-LUER RONGEUR

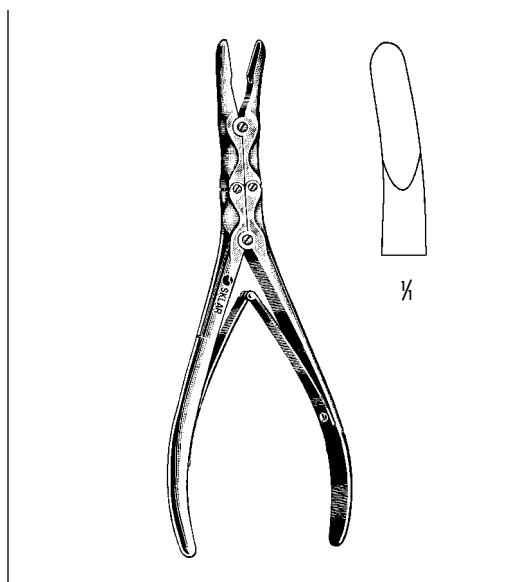
Double Action

- 40-3985 8½" Straight (A)
- 40-4085 8½" Curved (B)
- 40-4090 8½" Angular



STILLE-LUER ECHLIN RONGEUR

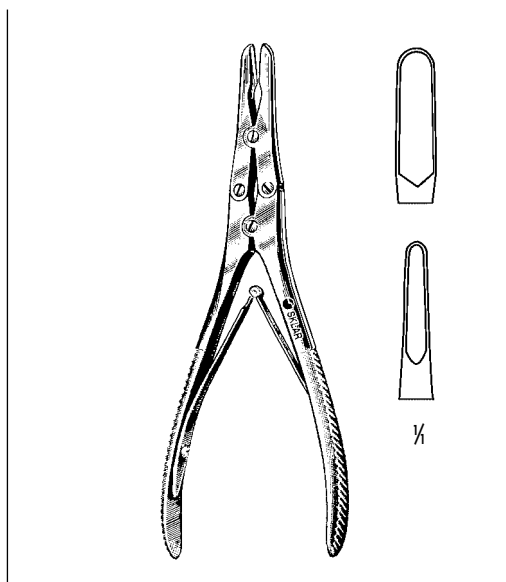
40-4125 9" 6 x 12 mm Jaws Angled to Side



ZAUFEL-JANSEN RONGEUR

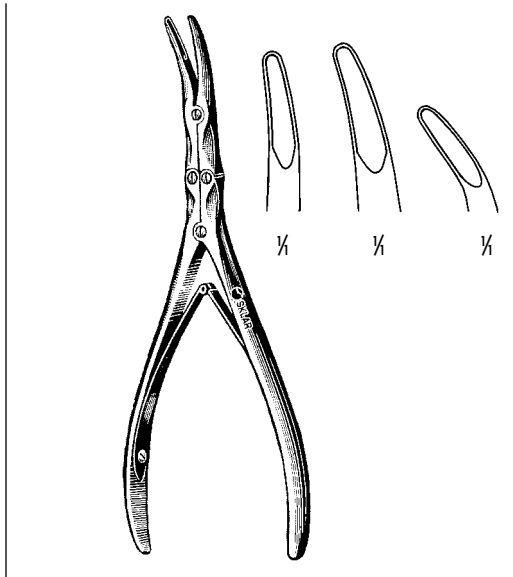
Double Action

40-4265 7" 5 x 15 mm Curved Bite



RUSKIN RONGEUR

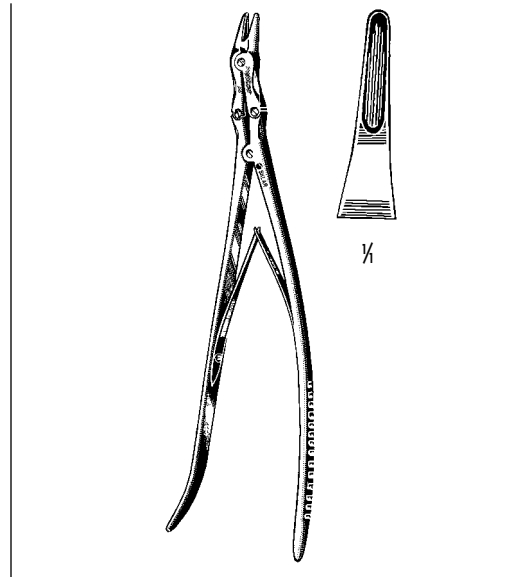
- 40-4360 6" Straight 2 mm Bite
- 40-4365 6" Curved 2 mm Bite
- 40-4272 7¼" Straight 5 mm Bite
- 40-4372 7¼" Curved 5 mm Bite
- 40-4472 7¼" Angled to Side 5 mm Bite
- 40-4512 9½" Curved



KLEINERT-KUTZ RONGEUR

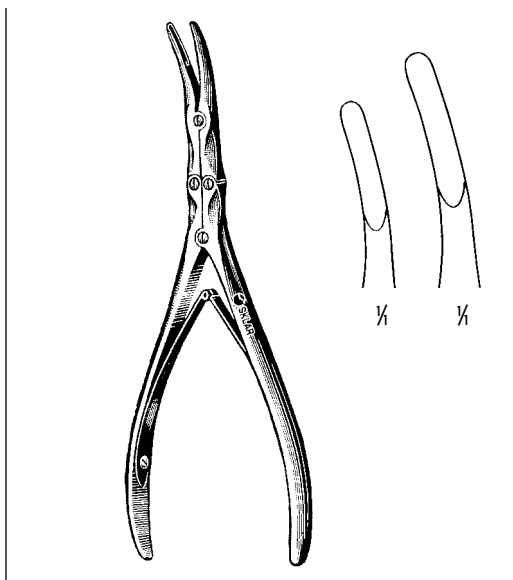
Double Action

40-4190	6"	Slight Curve	2 x 13 mm Bite
40-4192	6"	Curved	3 x 16 mm Bite
40-4194	6"	Full Curve	3 x 8 mm Bite



DALE FIRST RIB RONGEUR

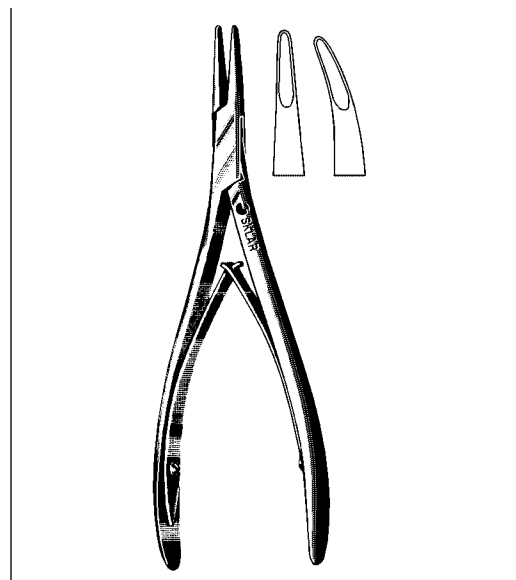
55-1530	14"	3 mm Bite
---------	-----	-----------



BEYER BONE RONGEUR

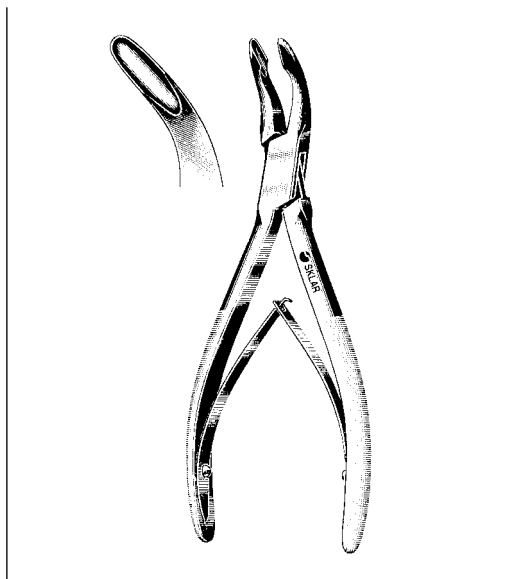
Double Action

40-4268	7"	Curved	3 x 14 mm Jaw
40-4270	7"	Curved	4 x 15 mm Jaw



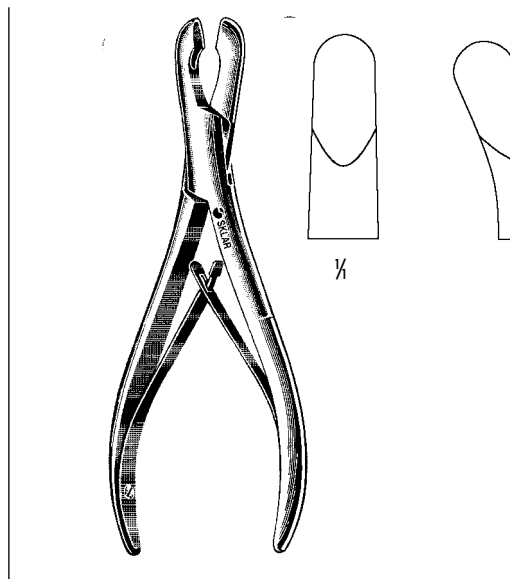
LEMPERT RONGEUR

47-2467	6 1/4"	Straight
47-2468	6 1/4"	Curved
47-2465	7 1/2"	Straight
47-2466	7 1/2"	Curved



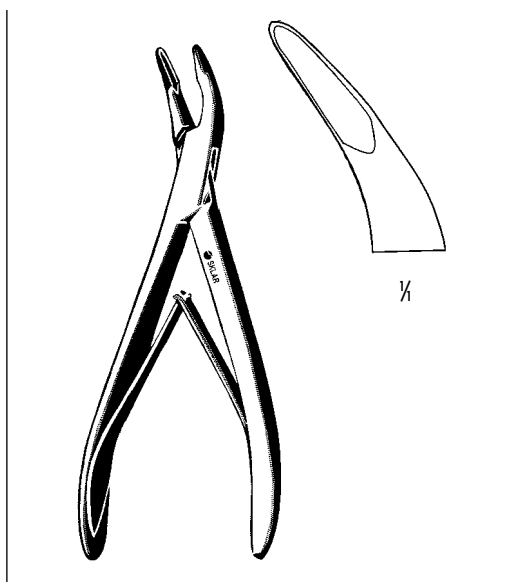
DEAN BONE RONGEUR

Single Action
47-2455 5½" Curved



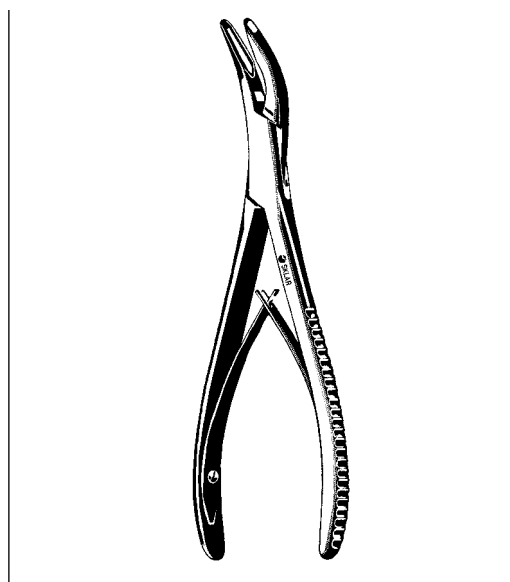
LUER BONE RONGEUR

40-3570	7"	Straight	8 mm x 10 mm
40-3670	7"	Curved	8 mm x 10 mm



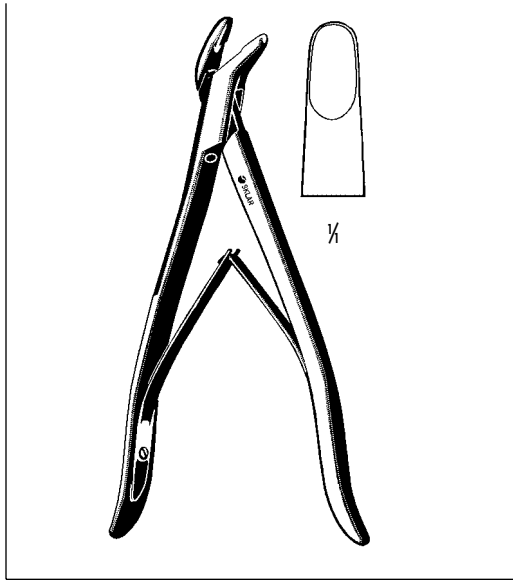
CICHERELLI RONGEUR

47-2470 6½"

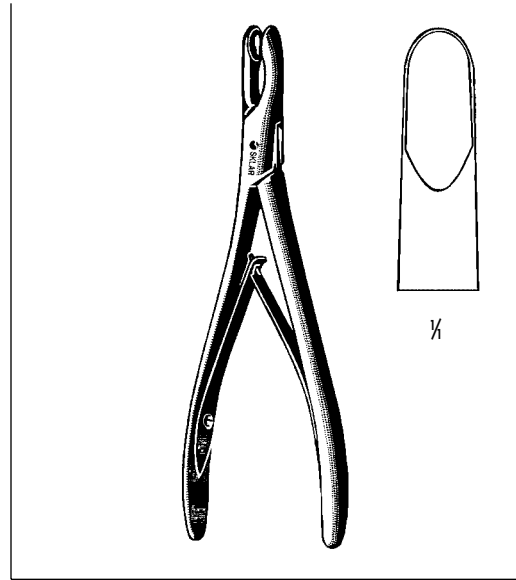


OLIVECRONA RONGEUR

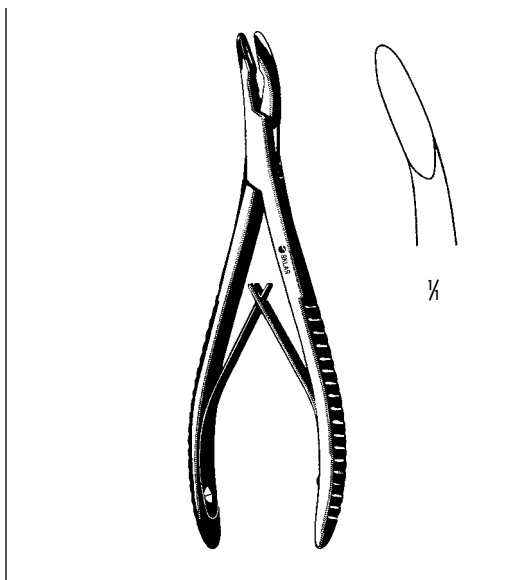
47-2480 7½"



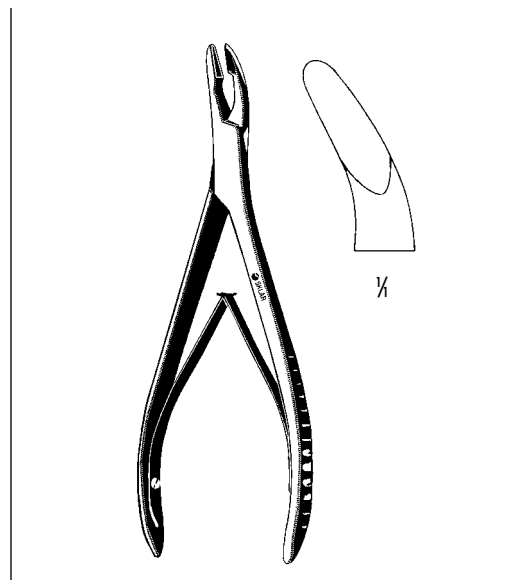
BACON RONGEUR
40-3480 8" Curved on Side 5 x 15 mm Bite



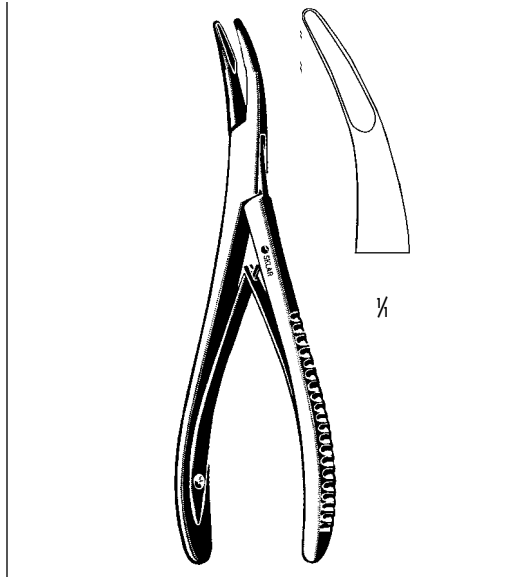
ADSON RONGEUR
50-1080 8"



BANE RONGEUR
67-5175 7" Curved 3 x 16 mm Bite

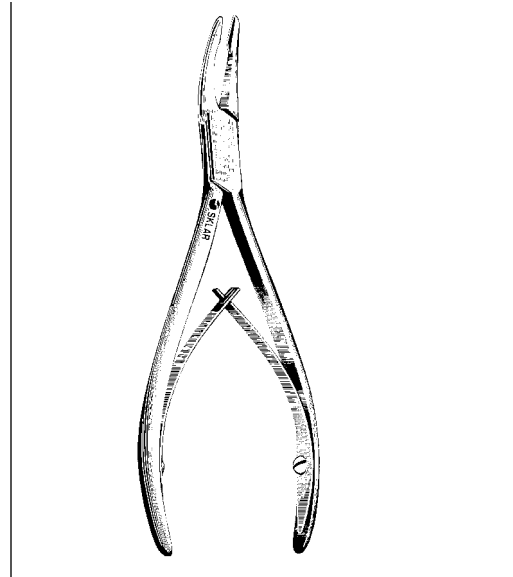


HARTMANN RONGEUR
67-5458 5 1/2" Full Curved 4 x 16 mm Bite



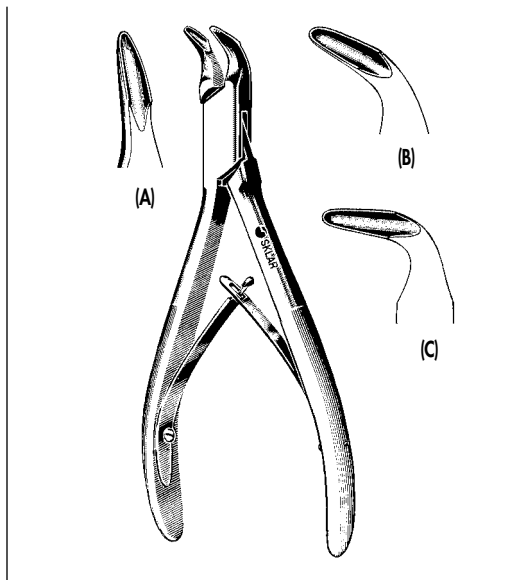
BEYER RONGEUR

40-3188 7"



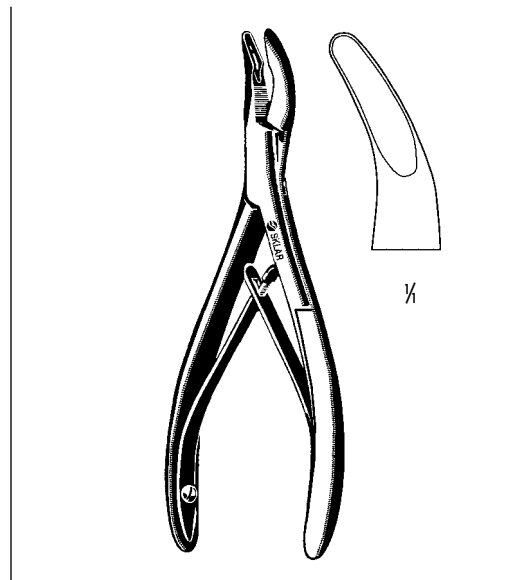
FRIEDMAN BONE RONGEUR

40-3190 5 1/2" Curved
40-3192 6 1/2" Curved



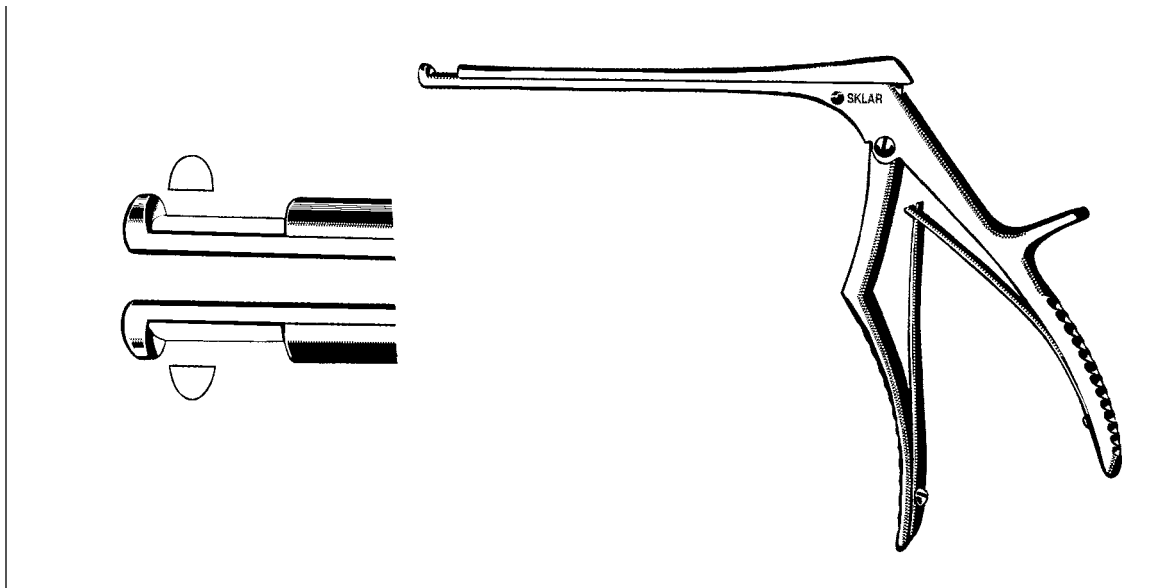
BLUMENTHAL RONGEUR

67-5990 6" 30° Angle (A)
67-5992 6" 45° Angle (B)
67-5994 6" 90° Angle (C)



MEAD RONGEUR

40-3208 6 1/2" Curved 4 x 13 mm Bite



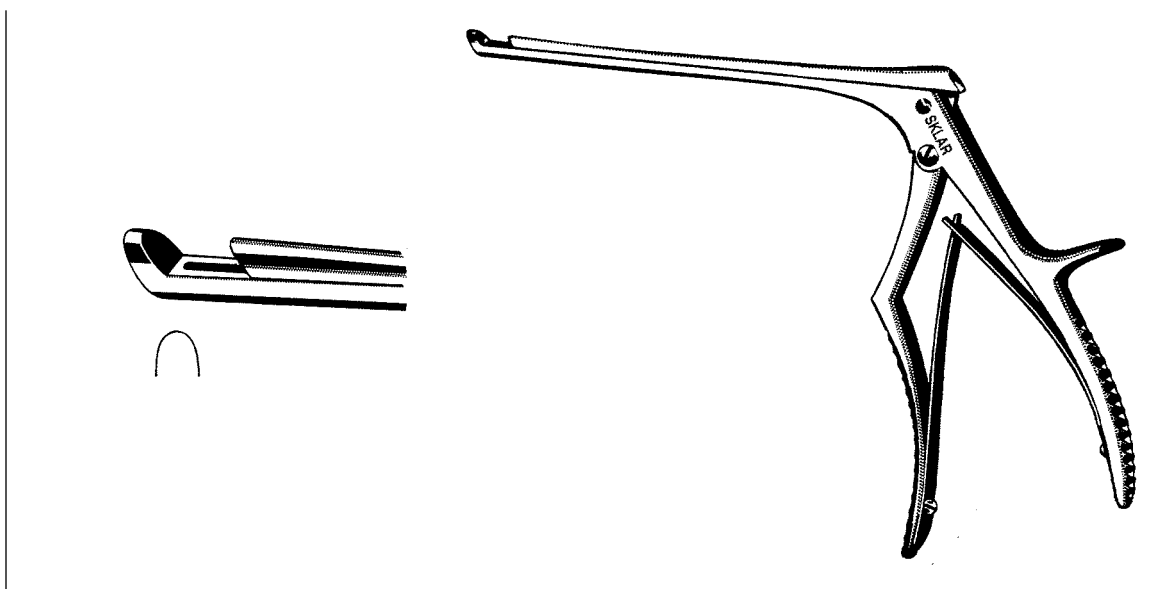
LOVE-KERRISON-SCHLESINGER-COLCLOUGH LAMINECTOMY RONGEUR

Up-Bite

42-3416	6"	Shaft	3 mm Bite
42-3417	6"	Shaft	4 mm Bite
42-3418	6"	Shaft	5 mm Bite
42-3453	8"	Shaft	3 mm Bite
42-3454	8"	Shaft	4 mm Bite
42-3455	8"	Shaft	5 mm Bite

Down-Bite

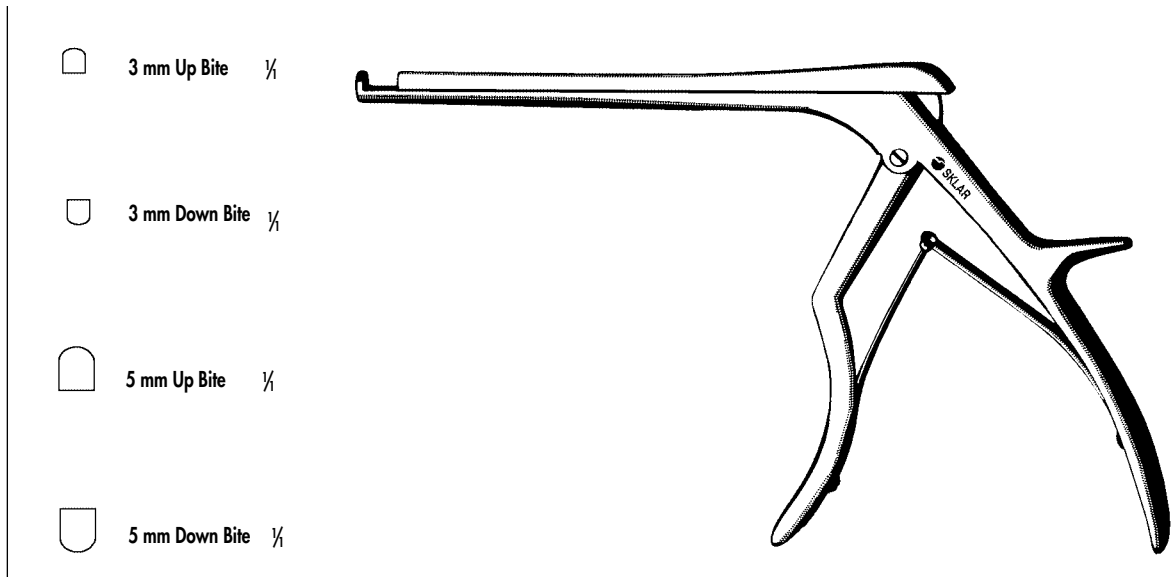
42-3425	6"	Shaft	3 mm Bite
42-3427	6"	Shaft	4 mm Bite
42-3429	6"	Shaft	5 mm Bite
42-3463	8"	Shaft	3 mm Bite
42-3464	8"	Shaft	4 mm Bite
42-3465	8"	Shaft	5 mm Bite



LOVE-KERRISON-SCHLESINGER-COLCLOUGH LAMINECTOMY RONGEUR

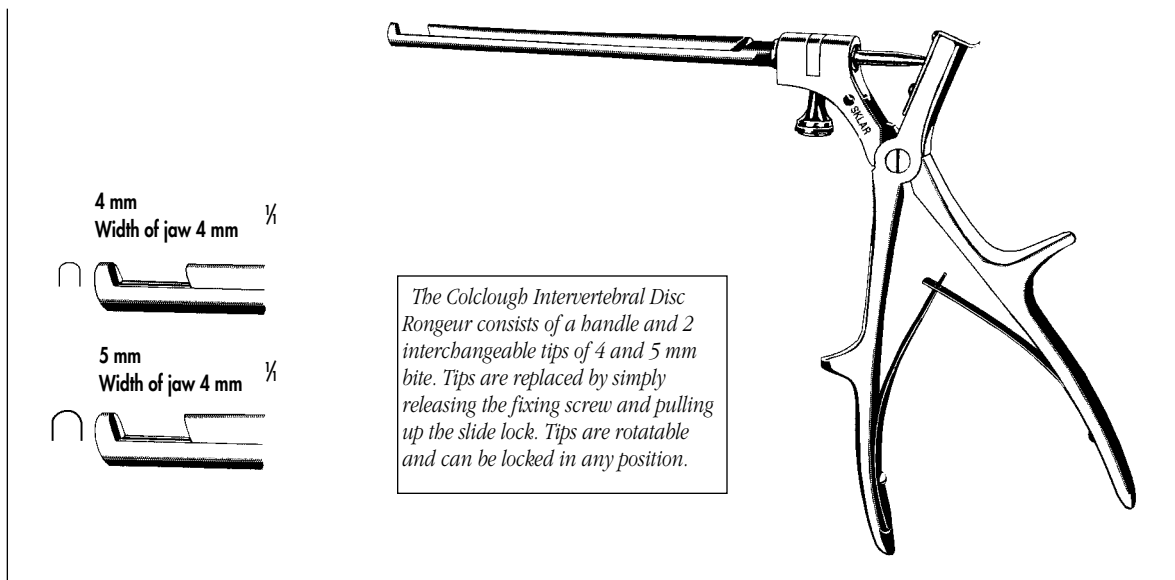
40° Forward Angled Tip

42-3430	6"	Shaft	3 mm Bite
42-3431	6"	Shaft	4 mm Bite
42-3432	6"	Shaft	5 mm Bite
42-3573	8"	Shaft	3 mm Bite
42-3574	8"	Shaft	4 mm Bite
42-3575	8"	Shaft	5 mm Bite



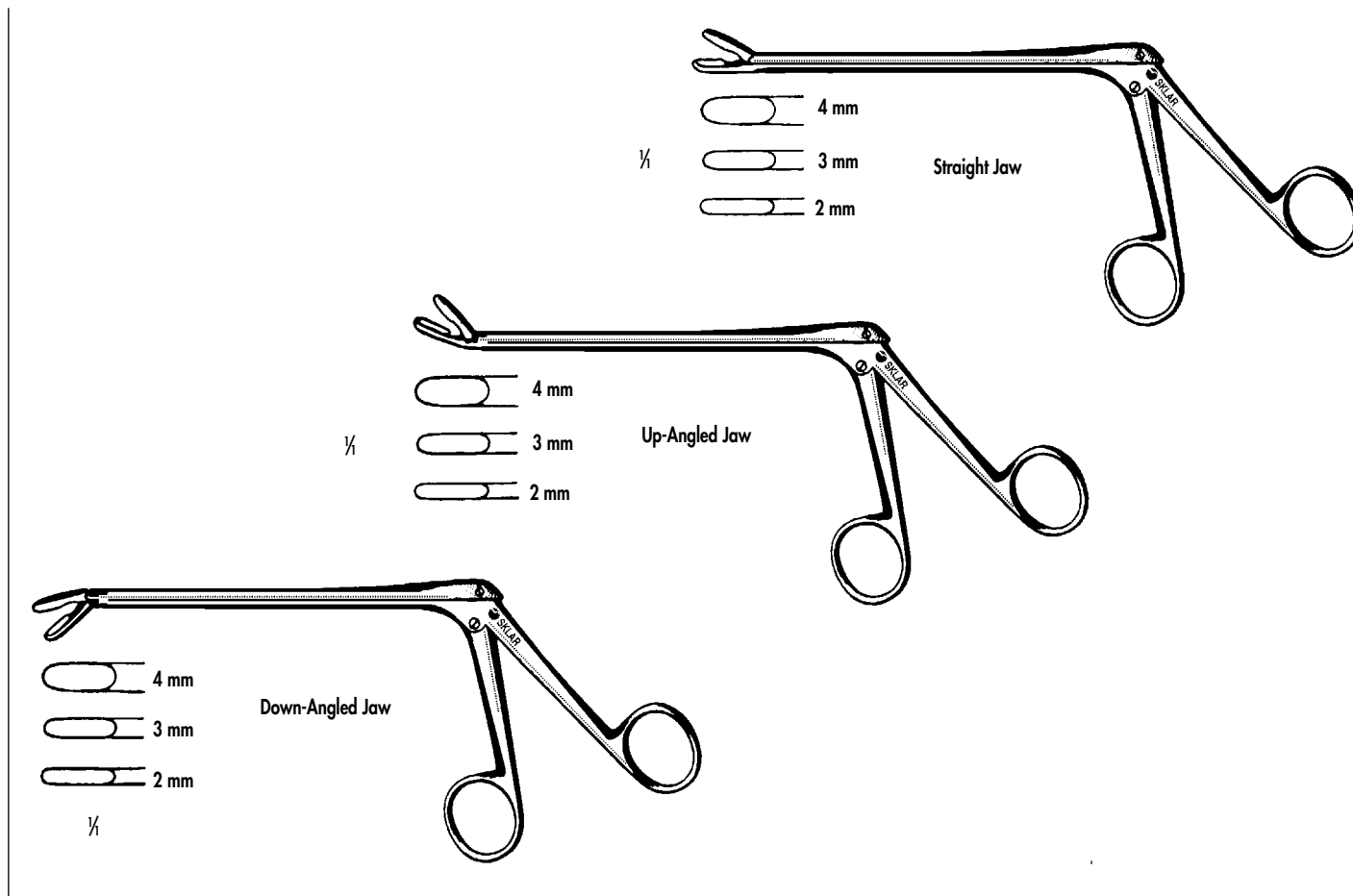
SCHLESINGER CERVICAL LAMINECTOMY RONGEUR

42-3435	6"	3 mm Up Bite
42-3436	6"	3 mm Down Bite
42-3437	6"	5 mm Up Bite
42-3438	6"	5 mm Down Bite



COLCLOUGH DISC RONGEUR

Universal
42-2150 Complete Set of 4 mm Jaw, 5 mm Jaw and Handle



INTERVERTEBRAL DISC RONGEUR (PITUITARY)

CUSHING

42-3920	5" (12.3 cm) Shaft	2 x 10 mm Cup	Straight
42-3921	5" (12.3 cm) Shaft	2 x 10 mm Cup	Up-Angle
42-3922	5" (12.3 cm) Shaft	2 x 10 mm Cup	Down-Angle

LOVE-GRUENWALD

42-3150	5" (12.7 cm) Shaft	3 x 10 mm Cup	Straight
42-3152	5" (12.7 cm) Shaft	3 x 10 mm Cup	Up-Angle
42-3154	5" (12.7 cm) Shaft	3 x 10 mm Cup	Down-Angle

CUSHING

42-3925	7" (17.8 cm) Shaft	2 x 10 mm Cup	Straight
42-3926	7" (17.8 cm) Shaft	2 x 10 mm Cup	Up-Angle
42-3927	7" (17.8 cm) Shaft	2 x 10 mm Cup	Down-Angle

LOVE-GRUENWALD

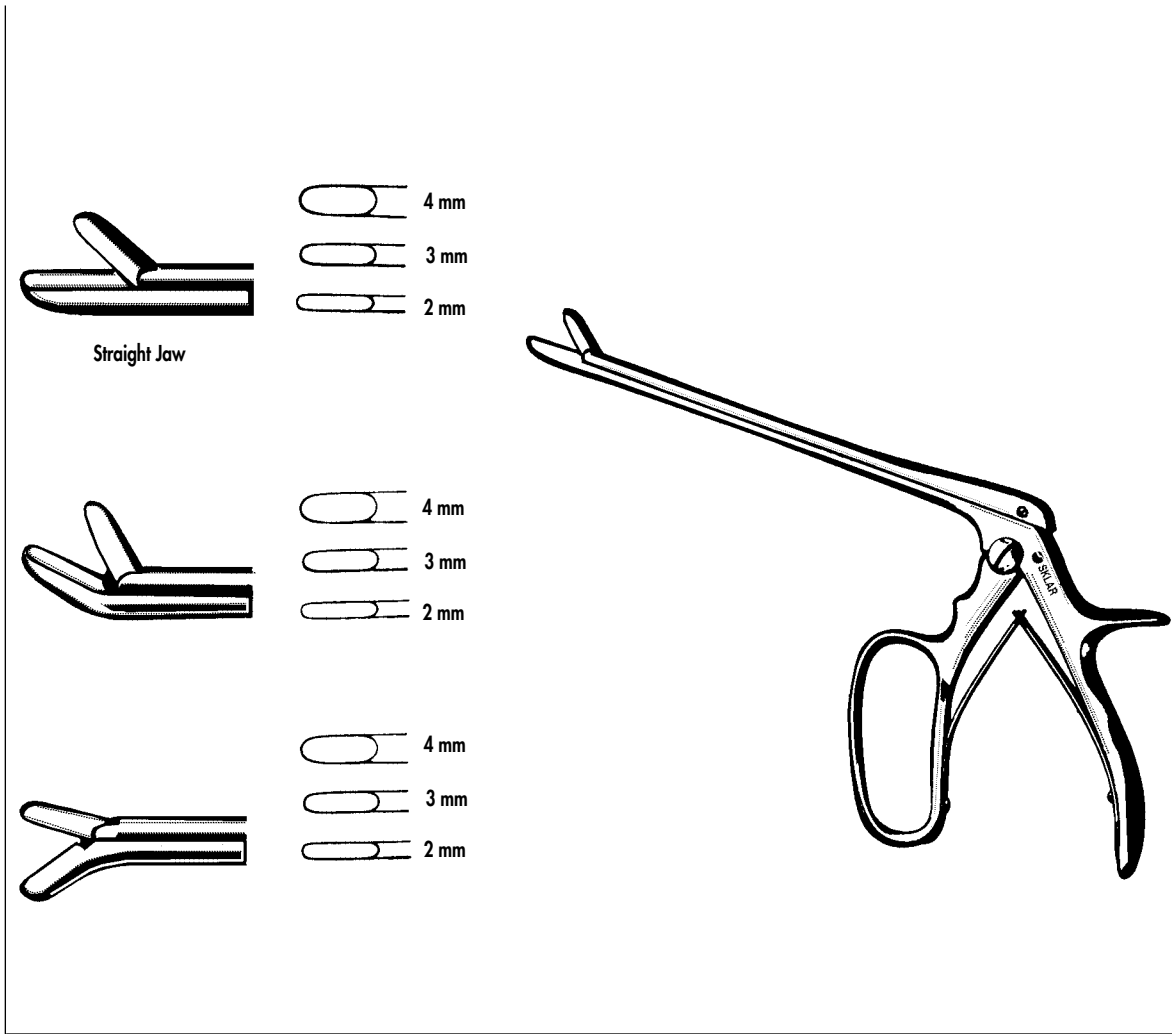
42-3156	7" (17.8 cm) Shaft	3 x 10 mm Cup	Straight
42-3158	7" (17.8 cm) Shaft	3 x 10 mm Cup	Up-Angle
42-3160	7" (17.8 cm) Shaft	3 x 10 mm Cup	Down-Angle

SPURLING

42-2850	5" (12.7 cm) Shaft	4 x 10 mm Cup	Straight
42-2851	5" (12.7 cm) Shaft	4 x 10 mm Cup	Up-Angle
42-2852	5" (12.7 cm) Shaft	4 x 10 mm Cup	Down-Angle

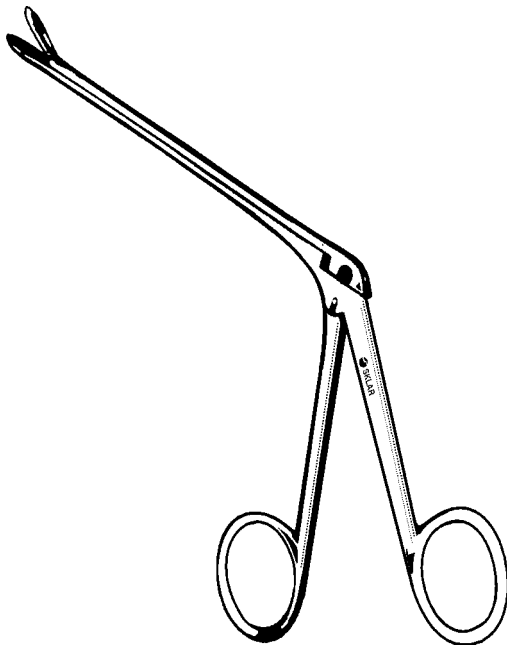
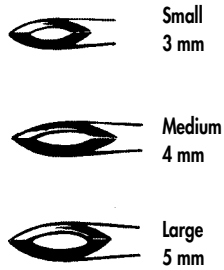
SPURLING

42-2855	7" (17.8 cm) Shaft	4 x 10 mm Cup	Straight
42-2856	7" (17.8 cm) Shaft	4 x 10 mm Cup	Up-Angle
42-2857	7" (17.8 cm) Shaft	4 x 10 mm Cup	Down-Angle



FERRIS SMITH INTERVERTEBRAL DISC RONGEUR (PITUITARY)

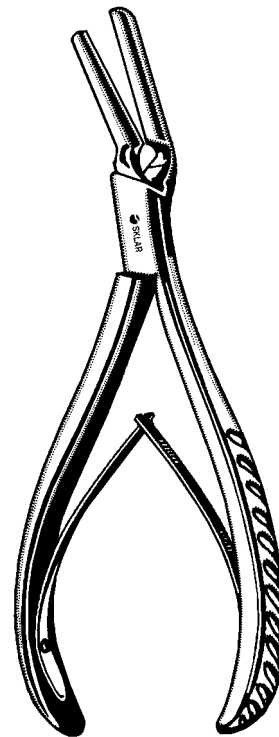
42-4000	7" (17.8 cm) Shaft	2 x 10 mm Cup	Straight
42-4001	7" (17.8 cm) Shaft	2 x 10 mm Cup	Up-Angle
42-4002	7" (17.8 cm) Shaft	2 x 10 mm Cup	Down-Angle
42-4005	7" (17.8 cm) Shaft	3 x 10 mm Cup	Straight
42-4006	7" (17.8 cm) Shaft	3 x 10 mm Cup	Up-Angle
42-4007	7" (17.8 cm) Shaft	3 x 10 mm Cup	Down-Angle
42-4010	7" (17.8 cm) Shaft	4 x 10 mm Cup	Straight
42-4011	7" (17.8 cm) Shaft	4 x 10 mm Cup	Up-Angle
42-4012	7" (17.8 cm) Shaft	4 x 10 mm Cup	Down-Angle
42-4015	7" (17.8 cm) Shaft	6 x 12 mm Cup	Straight
42-4016	7" (17.8 cm) Shaft	6 x 12 mm Cup	Up-Angle
42-4017	7" (17.8 cm) Shaft	6 x 12 mm Cup	Down-Angle



WILDE INTERVERTEBRAL DISC RONGEUR

Fenestrated Jaws

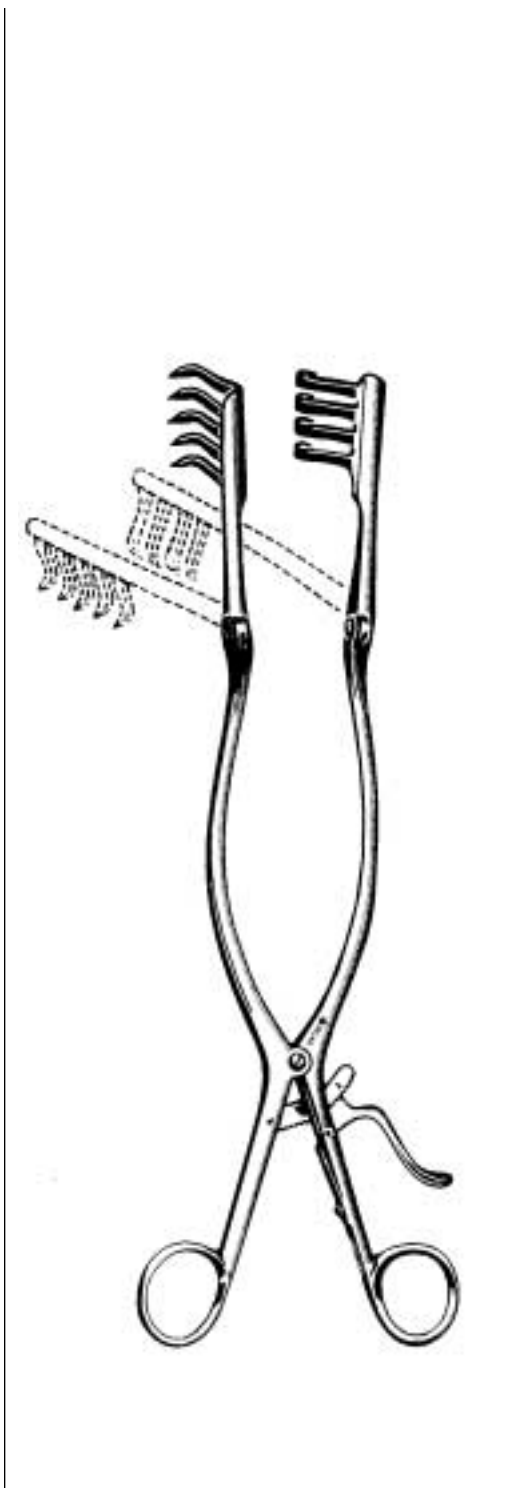
- 70-5420 5" Shaft Small, 3 mm Bite
- 70-5421 5" Shaft Med., 4 mm Bite
- 70-5422 5" Shaft Large, 5 mm Bite



ZIELKE INTERVERTEBRAL RONGEUR

Cutting edges extra long, angled up for removal of the intervertebral discs

- 42-4020 Straight 5 mm jaw
- 42-4022 Curved to Right 3.5 mm Jaw
- 42-4024 Curved to Left 3.5 mm Jaw

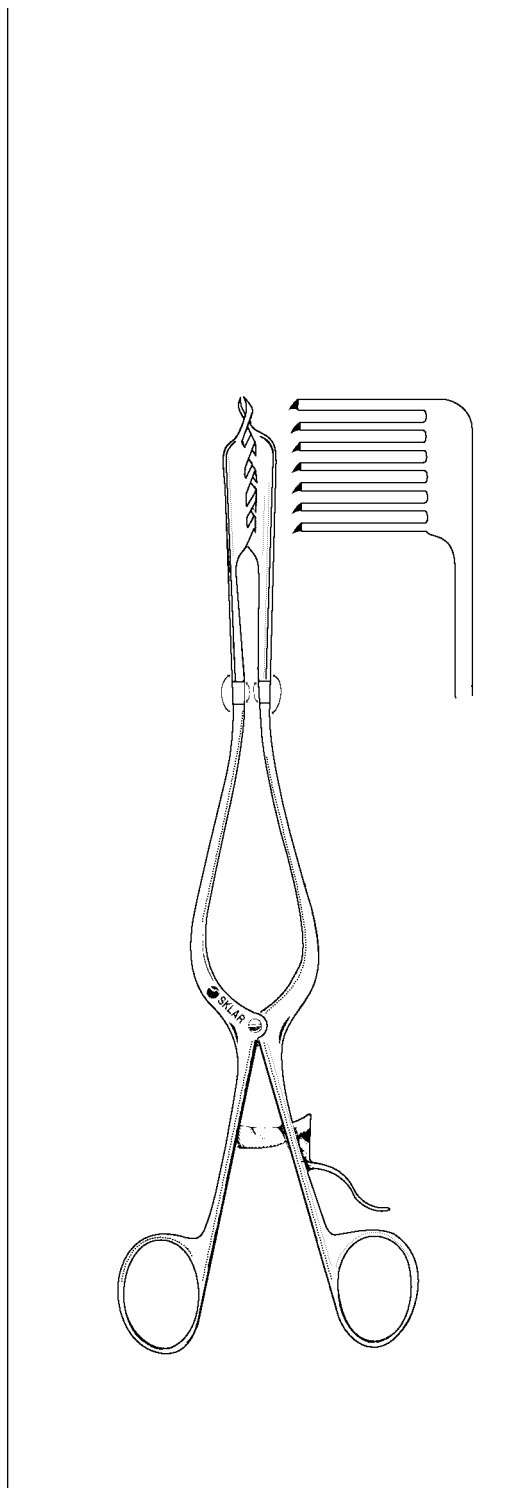


BECKMAN-ADSON RETRACTOR

57-1320 12½" with hinged blades Blunt 1" x 1" Deep Blades
 57-1322 12½" with hinged blades Sharp 1" x 1" Deep Blades

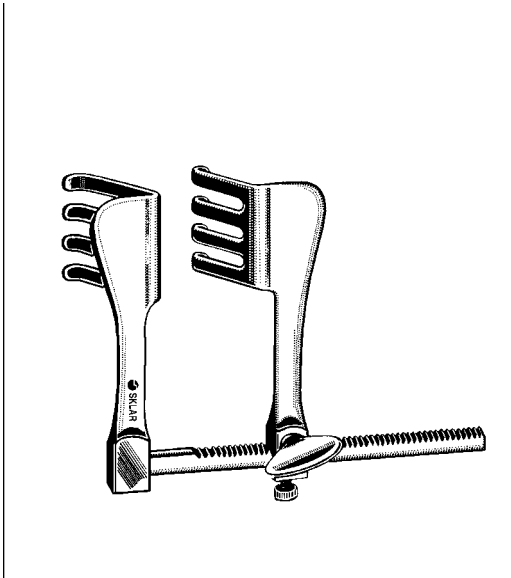
BECKMAN-WEITLANER RETRACTOR

42-1755 5½" with hinged blades, 3" x 4" Sharp
 42-1655 5½" with hinged blades, 3" x 4" Blunt



BECKMAN-EATON RETRACTOR

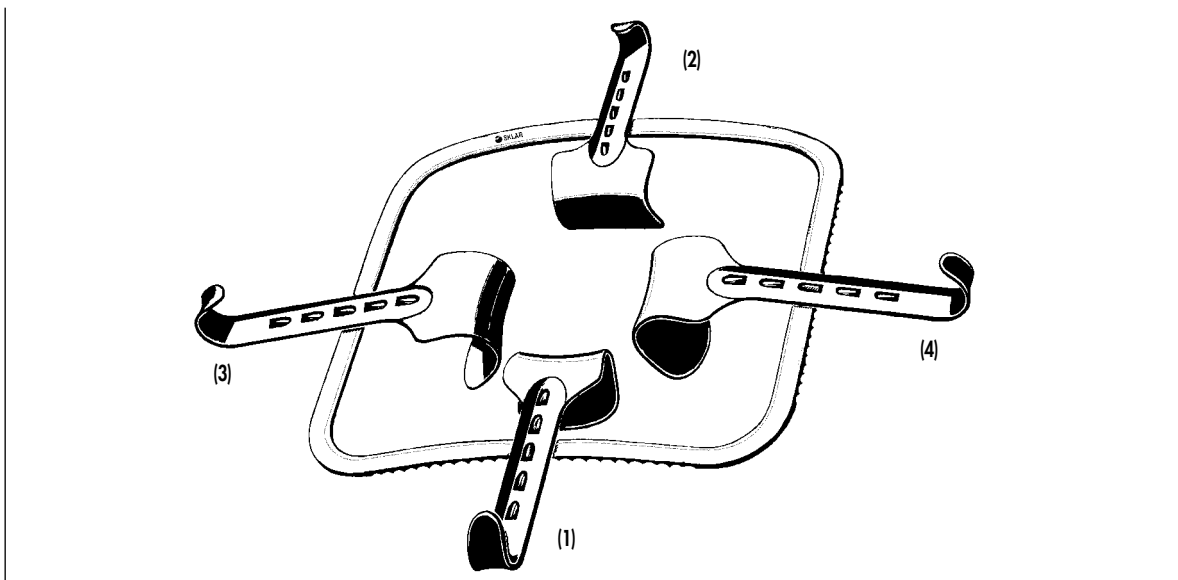
57-1325 13" 7 x 7 Sharp Prongs
 With Hinged Blades



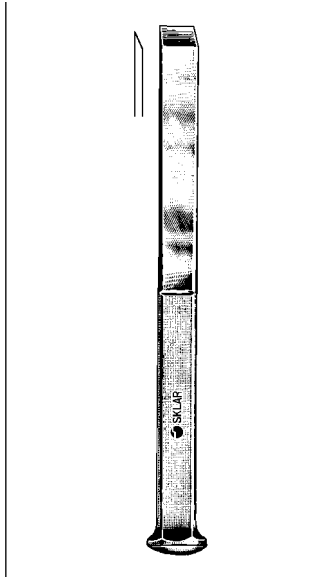
SKLAR NEURO RETRACTOR
42-1365 Blades 2" x 2" (5.1 cm x 5.1 cm)
 Spread 6½" (16.5 cm)



MEYERDING RETRACTOR
42-2095 Large

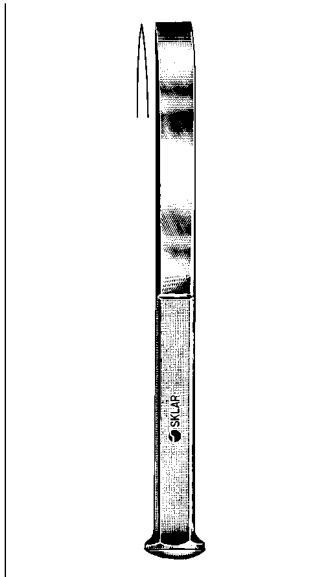


KIRSCHNER RETRACTOR
60-7200 Fixed Frame with 4 Blades
 Blades 1 and 2 40 x 55 mm
 Blades 3 and 4 50 x 65 mm



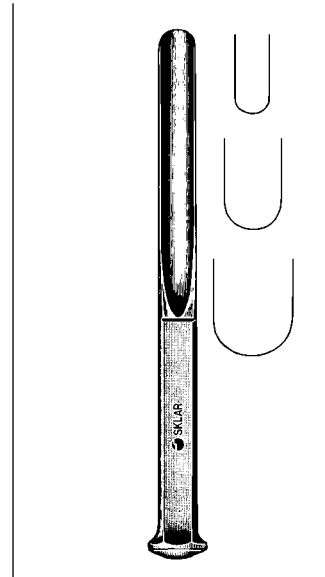
ARMY PATTERN CHISEL

40-6106	6½"	6 mm
40-6112	6½"	12 mm
40-6118	6½"	18 mm



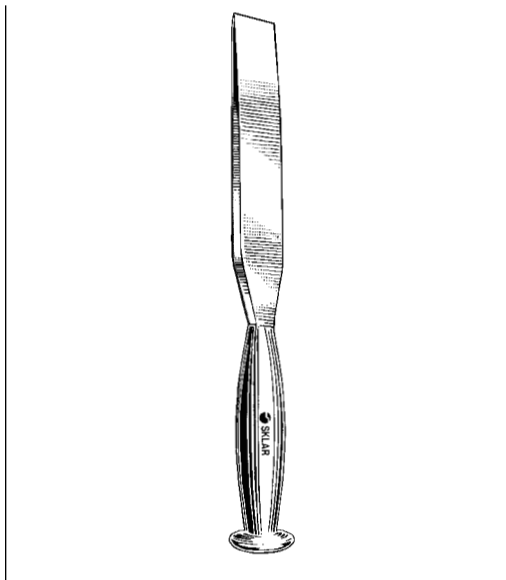
ARMY PATTERN OSTEOTOME

40-6206	6½"	6 mm
40-6212	6½"	12 mm
40-6218	6½"	18 mm



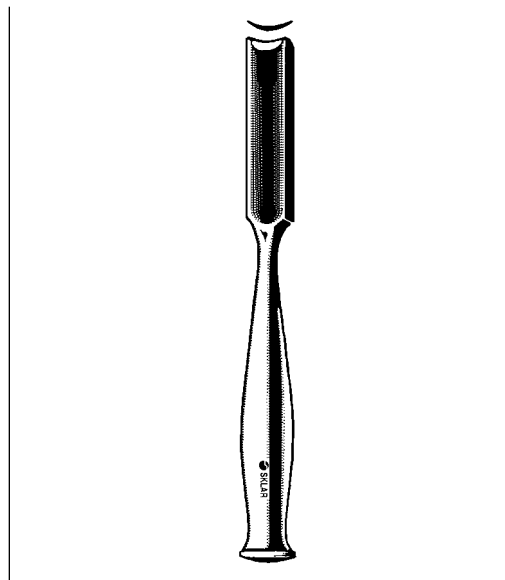
ARMY PATTERN GOUGE

40-6306	6½"	6 mm
40-6312	6½"	10 mm
40-6318	6½"	14 mm



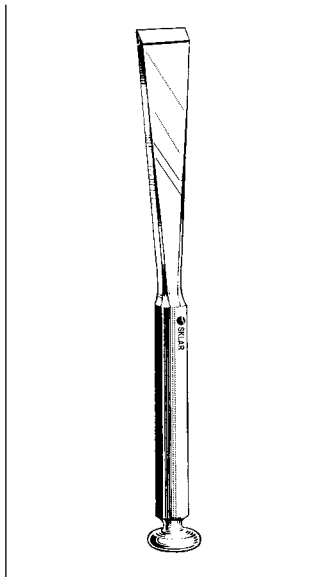
SMITH PETERSON OSTEOTOME

8" (20.3 cm) Straight	8" (20.3 cm) Curved
40-6771 ¼" (.6 cm)	40-6781 ¼" (.6 cm)
40-6772 ⅜" (1. cm)	40-6782 ⅜" (1. cm)
40-6773 ½" (1.3 cm)	40-6783 ½" (1.3 cm)
40-6774 ⅝" (1.6 cm)	40-6784 ⅝" (1.6 cm)
40-6775 ¾" (1.9 cm)	40-6785 ¾" (1.9 cm)
40-6776 1" (2.5 cm)	40-6786 1" (2.5 cm)
40-6777 1¼" (4.1 cm)	40-6787 1¼" (4.1 cm)



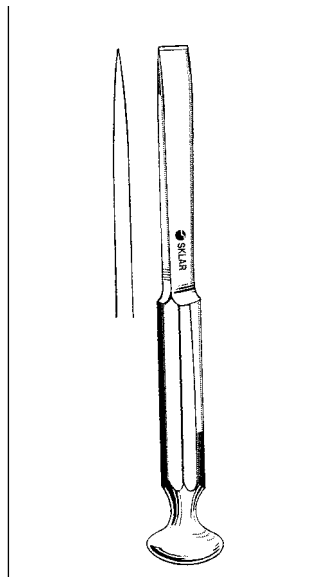
SMITH PETERSON GOUGE

8" (20.3 cm) Straight	8" (20.3 cm) Curved
40-6791 ¼" (.6 cm)	40-6799 ¼" (.6 cm)
40-6792 ⅜" (1. cm)	40-6800 ⅜" (1. cm)
40-6793 ½" (1.3 cm)	40-6801 ½" (1.3 cm)
40-6794 ⅝" (1.6 cm)	40-6802 ⅝" (1.6 cm)
40-6795 ¾" (1.9 cm)	40-6803 ¾" (1.9 cm)
40-6796 1" (2.5 cm)	40-6804 1" (2.5 cm)
40-6797 1¼" (4.1 cm)	40-6805 1¼" (4.1 cm)



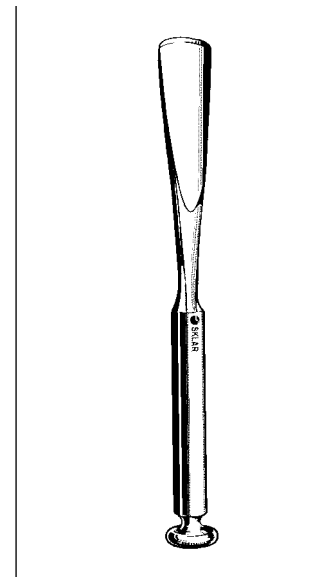
STILLE TYPE CHISEL

40-6338	8"	10 mm
40-6339	8"	14 mm
40-6340	8"	18 mm
40-6341	8"	22 mm



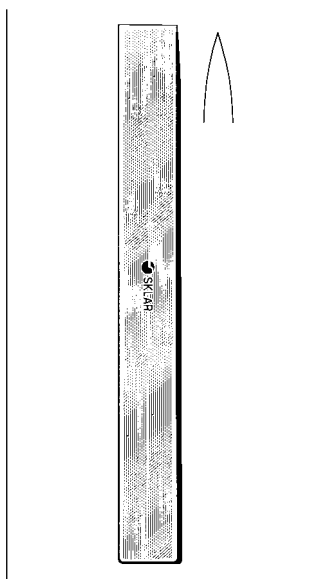
STILLE TYPE OSTEOTOME

40-6330	8"	10 mm
40-6331	8"	14 mm
40-6332	8"	18 mm
40-6333	8"	22 mm



STILLE TYPE GOUGE

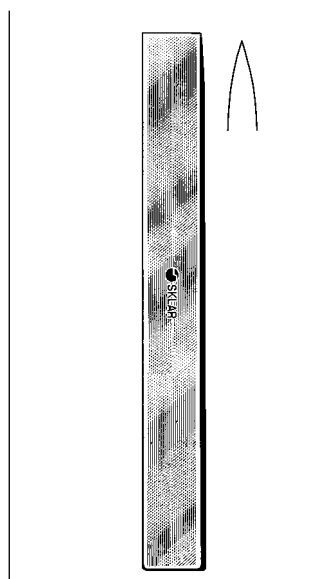
40-6334	8"	10 mm
40-6335	8"	14 mm
40-6336	8"	18 mm
40-6337	8"	22 mm



LAMBOTTE OSTEOTOME

Straight Delicate 5"

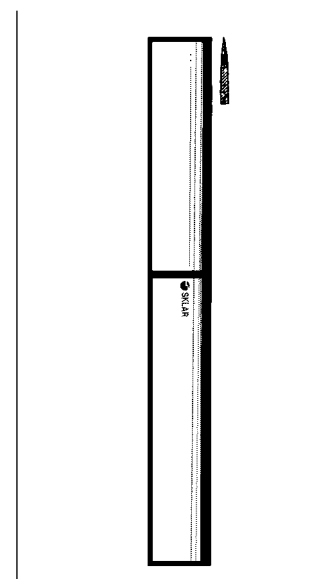
40-6534	4 mm
40-6536	6 mm
40-6538	8 mm
40-6540	10 mm
40-6542	12 mm
40-6545	15 mm
40-6549	19 mm
40-6550	20 mm



LAMBOTTE OSTEOTOME

Straight 7"

40-6624	4 mm	40-6632	12 mm
40-6625	5 mm	40-6636	16 mm
40-6626	6 mm	40-6639	19 mm
40-6628	8 mm	40-6642	22 mm
40-6630	10 mm	40-6645	25 mm



LAMBOTTE OSTEOTOME

Straight 9"

40-6560	1/4"	(6 mm)	40-6570	1/4"	(6 mm)
40-6561	1/2"	(13 mm)	40-6571	1/2"	(13 mm)
40-6562	3/4"	(19 mm)	40-6572	3/4"	(19 mm)
40-6563	1"	(25 mm)	40-6573	1"	(25 mm)
40-6564	1 1/4"	(31 mm)	40-6574	1 1/4"	(31 mm)
40-6565	1 1/2"	(38 mm)	40-6575	1 1/2"	(38 mm)

Curved 9"



HIBBS CHISEL

Straight 9½"

40-6701	6 mm	40-6723	22 mm
40-6711	10 mm	40-6724	25 mm
40-6715	13 mm	40-6725	28 mm
40-6716	16 mm	40-6726	31 mm
40-6717	19 mm	40-6728	38 mm

Curved 9½"

40-6731	6 mm	40-6736	22 mm
40-6732	10 mm	40-6737	25 mm
40-6733	13 mm	40-6738	28 mm
40-6734	16 mm	40-6739	31 mm
40-6735	19 mm	40-6740	38 mm



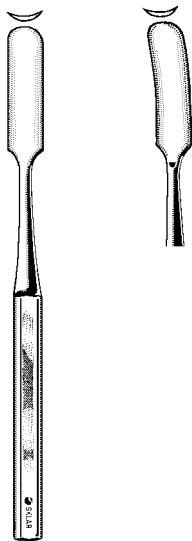
HIBBS OSTEOTOME

Straight 9½"

40-6666	6 mm	40-6671	22 mm
40-6667	10 mm	40-6672	25 mm
40-6668	13 mm	40-6673	28 mm
40-6669	16 mm	40-6674	31 mm
40-6670	19 mm	40-6675	38 mm

Curved 9½"

40-6680	6 mm	40-6685	22 mm
40-6681	10 mm	40-6686	25 mm
40-6682	13 mm	40-6687	28 mm
40-6683	16 mm	40-6688	31 mm
40-6684	19 mm	40-6689	38 mm



HIBBS GOUGE

Straight 9½"

40-6833	5/8"	(1.6 cm)
40-6835	7/8"	(2.2 cm)
40-6836	1"	(2.5 cm)
40-6837	1 1/8"	(2.8 cm)
40-6838	1 1/4"	(3.1 cm)
40-6839	1 1/2"	(3.8 cm)

Curved 9½"

40-6843	5/8"	(1.6 cm)
40-6845	7/8"	(2.2 cm)
40-6846	1"	(2.5 cm)
40-6847	1 1/8"	(2.8 cm)
40-6848	1 1/4"	(3.1 cm)
40-6849	1 1/2"	(3.8 cm)



HOKE CHISEL

Straight 5½"

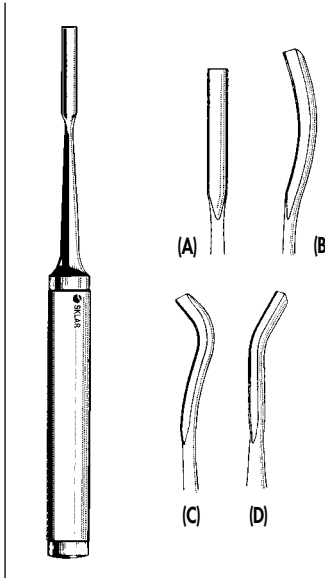
40-6984	4 mm
40-6986	6 mm
40-6990	10 mm
40-6993	13 mm
40-6996	16 mm
40-6999	19 mm



HOKE OSTEOTOME

Straight 5½"

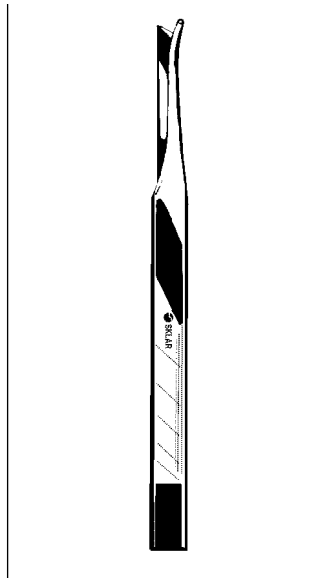
40-6953	3 mm	40-6970	10 mm
40-6954	4 mm	40-6973	13 mm
40-6956	6 mm	40-6976	16 mm
40-6958	8 mm	40-6979	19 mm



COBB TYPE SPINAL GOUGES

11" $\frac{5}{32}$ " Blade Width

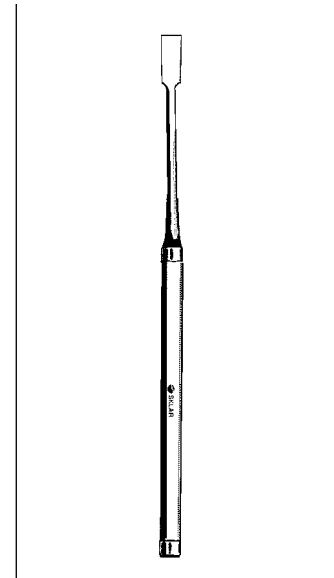
- 40-6920 Straight (A)
- 40-6921 Medium (B)
- 40-6922 Strong Curve (C)
- 40-6923 Reverse Curve (D)



SILVER OSTEOTOME

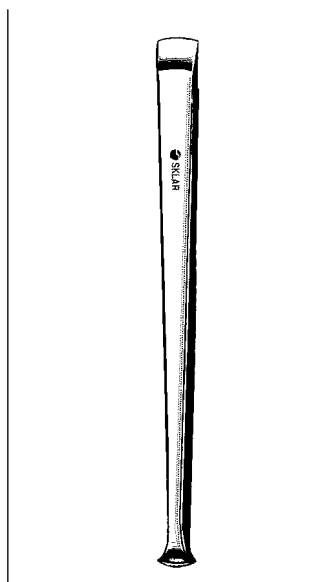
7" with Single Guard

- 41-1350 Straight
- 41-1355 Right
- 41-1360 Left



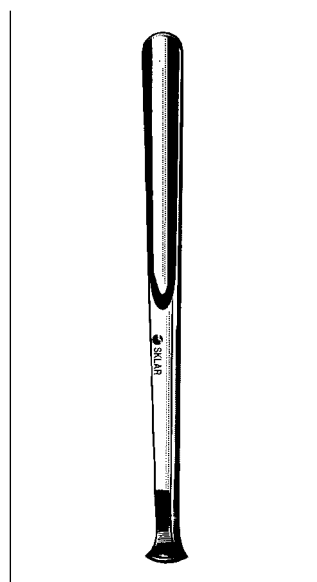
SKLAR OSTEOTOME

70-7170 6" 5 mm wide



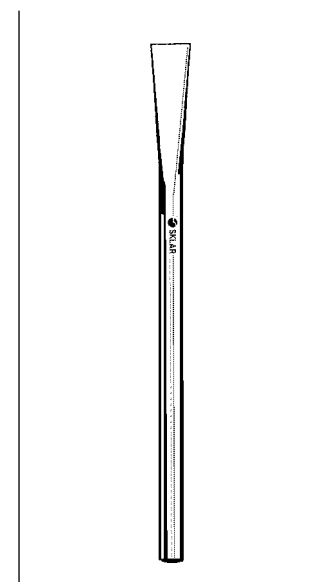
ALEXANDER MASTOID CHISELS

- 7"
- 67-4604 4 mm
- 67-4606 6 mm
- 67-4608 8 mm
- 67-4610 10 mm
- 67-4612 12 mm
- 67-4614 14 mm



ALEXANDER MASTOID GOUGES

- 7"
- 67-4504 4 mm
- 67-4506 6 mm
- 67-4508 8 mm
- 67-4510 10 mm
- 67-4512 12 mm
- 67-4514 14 mm



SHEEHAN OSTEOTOME

- Straight $6\frac{1}{4}$ "
- 67-4620 2 mm
- 67-4622 4 mm
- 67-4624 6 mm
- 67-4626 8 mm
- 67-4628 10 mm
- 67-4630 12 mm
- 67-4632 15 mm



FERRET GOUGE

With Sklar-Dura™ Handle
40-6094 6 mm



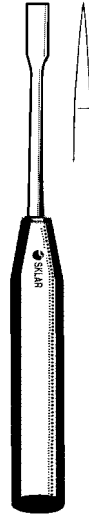
LAMINA GOUGE

With Sklar-Dura™ Handle
40-6096 3/4" 16 mm



LEXER MINI GOUGE

With Sklar-Dura™ Handle
40-6072 7" 6 mm



LEXER MINI CHISEL

With Sklar-Dura™ Handle
40-6020 7" 4 mm
40-6022 7" 6 mm
40-6024 7" 8 mm
40-6026 7" 10 mm
40-6028 7" 12 mm



CAPENER LAMINA GOUGE

With Sklar-Dura™ Handle
40-6078 9 1/4" Long 3/8" Wide



CAPENER OSTEOTOME

With Sklar-Dura™ Handle 10"
40-6080 3/8" Straight 10 mm
40-6082 1/2" Straight 12 mm
40-6084 5/8" Straight 15 mm
40-6085 3/4" Straight 20 mm
40-6086 1" Straight 25 mm
40-6088 1 1/4" Straight 30 mm



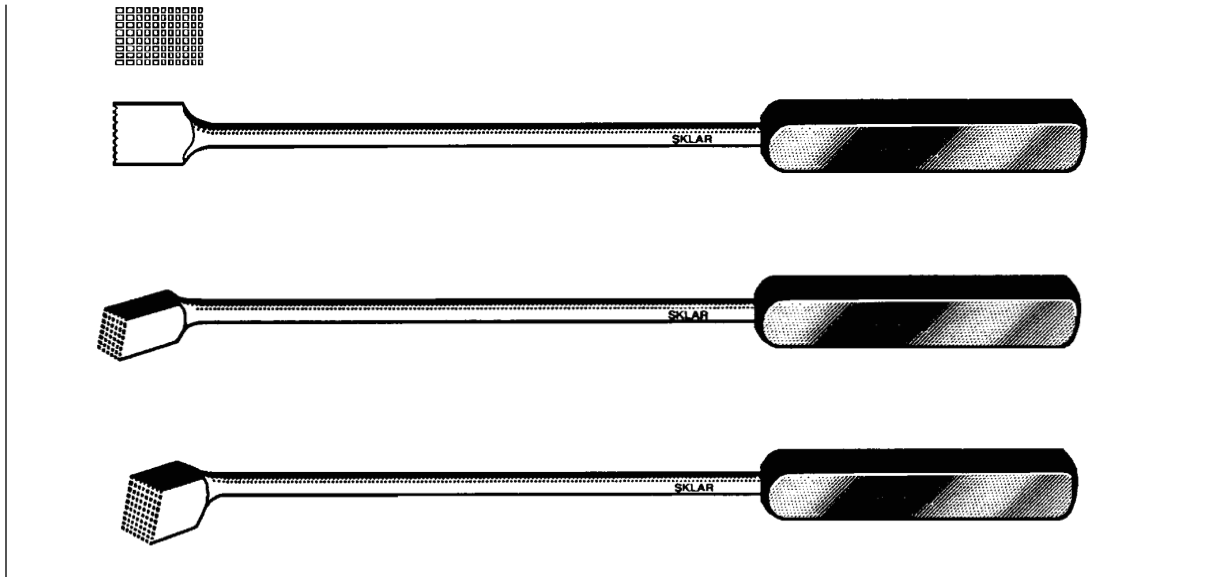
CAPENER OSTEOTOME

With Sklar-Dura™ Handle 10"
40-6092 1 1/4" Curved 30 mm
40-6093 1/2" Curved 12 mm



HIBBS OSTEOTOME

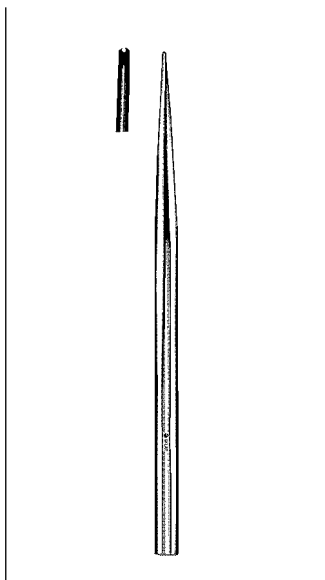
With Sklar-Dura™ Handle
40-6056 1/2" Straight 12 mm
40-6060 3/4" Straight 20 mm



HARMS IMPACTOR

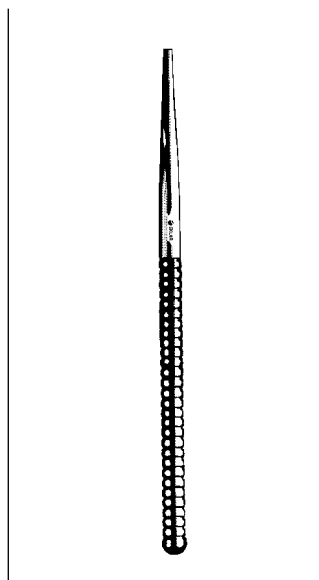
Lightweight Tempered • Stainless Steel
Greater Control • Autoclavable

- 40-7346 13½" Straight Large
- 40-7347 13½" Angled Small
- 40-7348 13½" Angled Large



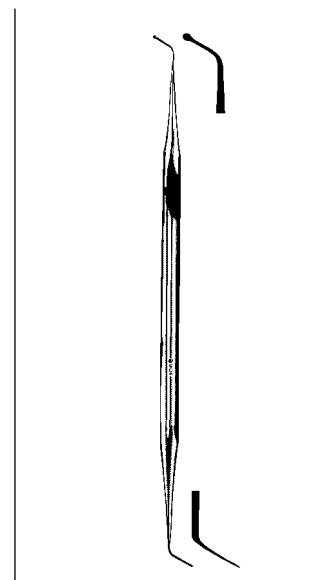
BONE TAMPER

With Concave Tip
40-7349 6" 2 mm diameter



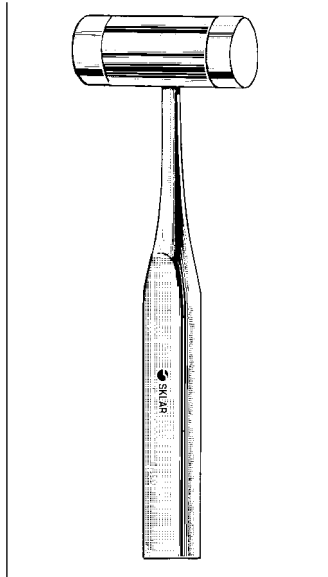
BONE TAMPER

- 6" with cross serrated tip
- 40-7360 2 mm diameter
- 40-7362 3 mm diameter
- 40-7364 4 mm diameter
- 40-7366 5 mm diameter
- 40-7368 6 mm diameter
- 40-7370 8 mm diameter
- 40-7372 10 mm diameter



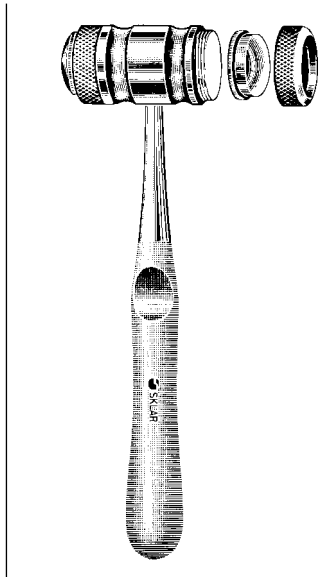
BONE PACKER DISSECTOR

- 6¾"
- 40-7376 1.4 mm Ball End
2.5 mm Blade End



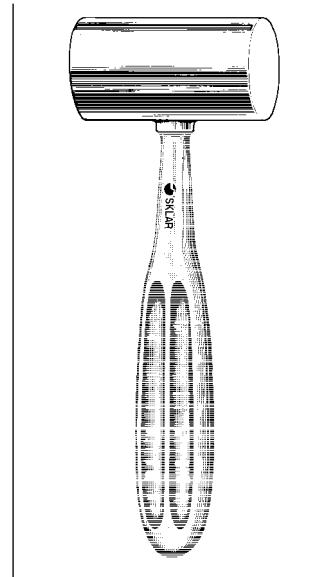
MALLET WITH TWO PLASTIC ENDS

Replaceable
40-5925 Flat Surfaces
40-5926 Replaceable Ends



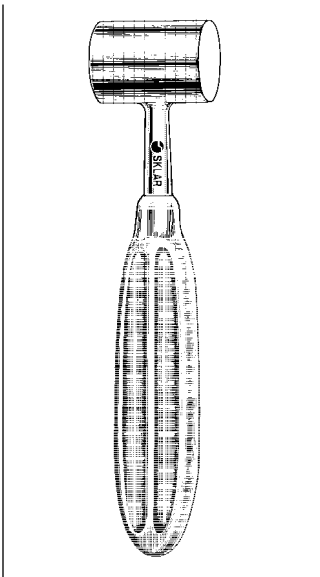
SKLAR MALLET

With Replaceable Plastic Discs
40-5870 Rounded Surfaces
40-5871 Replaceable Discs



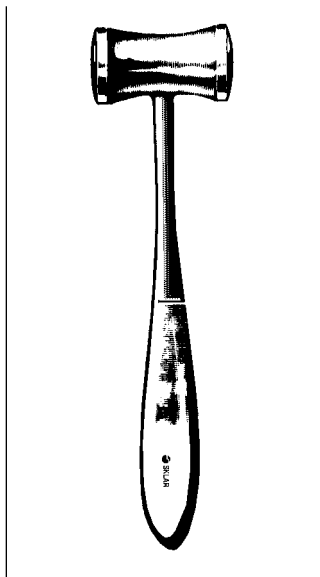
KIRK BONE MALLET

Solid Head-26 oz.
40-5672 7 1/4" 1 1/2" Diameter



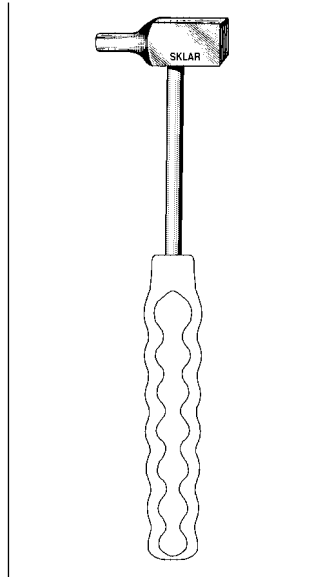
GERZOG BONE MALLET

Lead Filled-14 oz.
40-5765 7 1/2" 1" Diameter



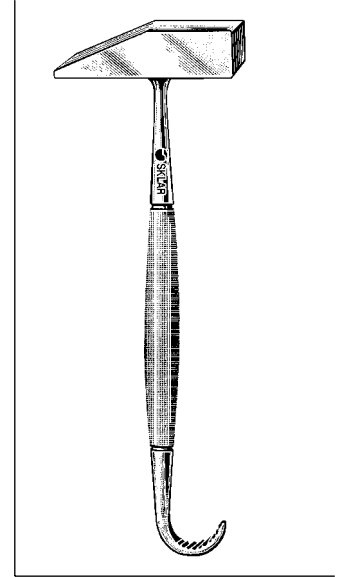
LUCAE MALLET

Bronze Head Small-8 oz.
40-5875 7 1/2" 1" Diameter
Chrome Plated



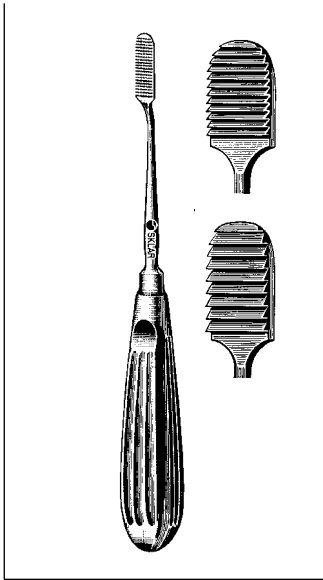
SKLAR MALLET

40-5940 8 3/4" With white plastic autoclavable handle



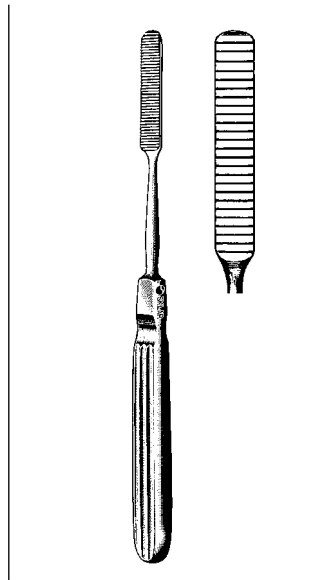
STEEL BONE MALLET

Hook Handle
40-5910 10" 20 oz.



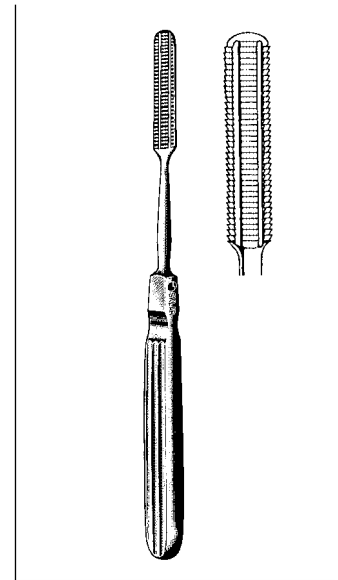
LEWIS RASP

70-2292 7" Fine
70-2293 7" Coarse



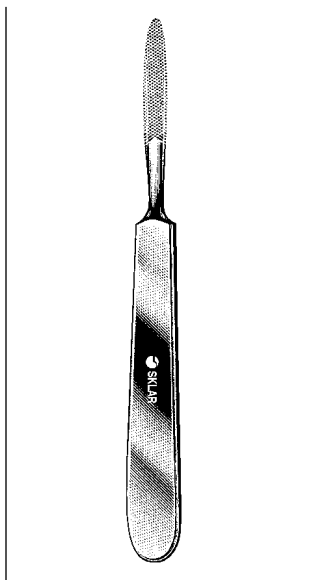
COTTLE RASP

40-9820 8"



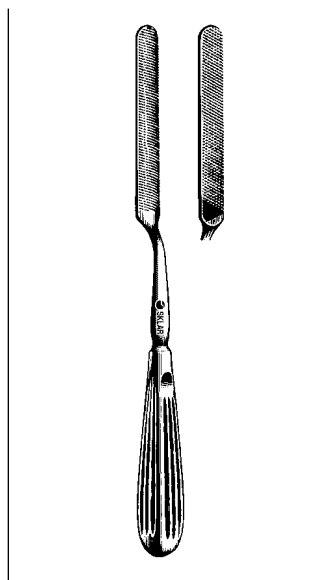
MALTZ RASP

40-9815 7"



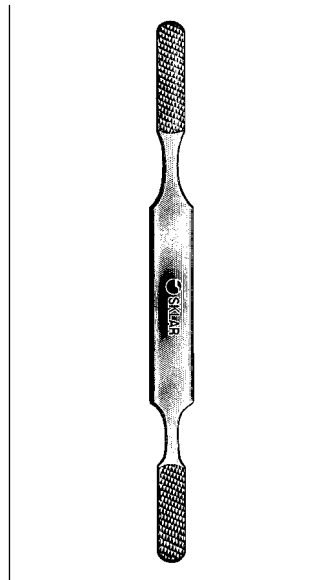
JOSEPH RASP

Straight Handle
40-9825 6 1/4"



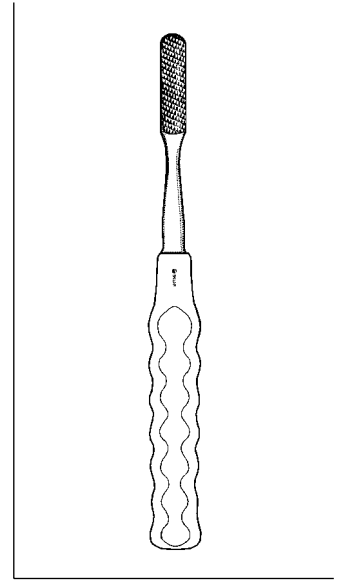
BONE FILE

Bayonet Handle
40-9685 8 1/2"



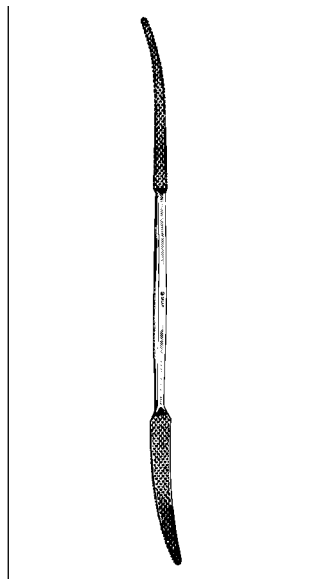
FOMON RASP AND FILE

Double End
40-9688 8 1/2"



LINK RASP

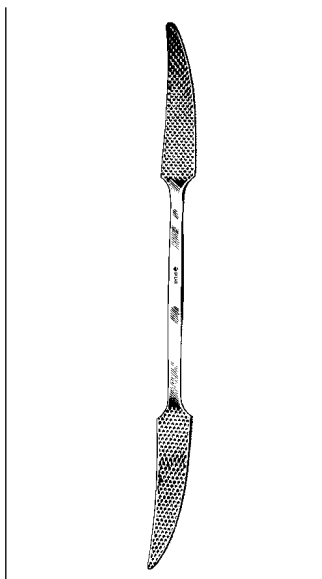
Single End
40-9690 7" 6.5 mm
Bi-directional cutting
lightweight, autoclavable
handle.



PUTTI BONE RASP

Curved Ends

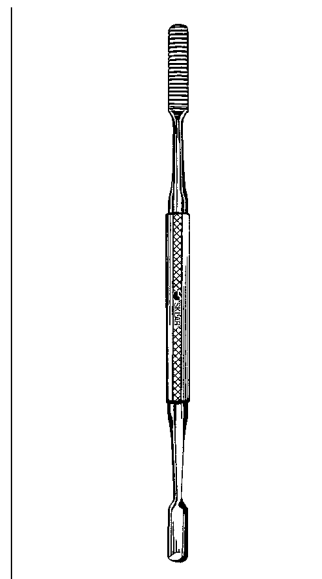
40-9712 12" Round and half-round tapered



PUTTI BONE RASP

Flat Ends

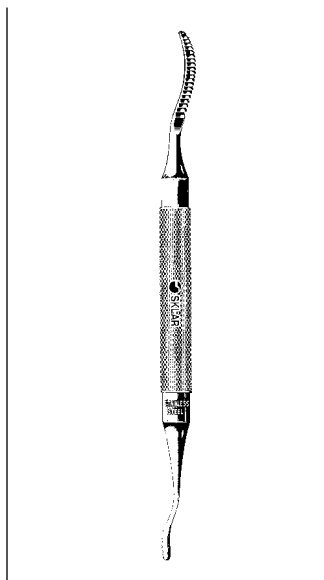
40-9812 10½" One side curved on flat, other side curved sideways.



NAIL AND BONE RASP

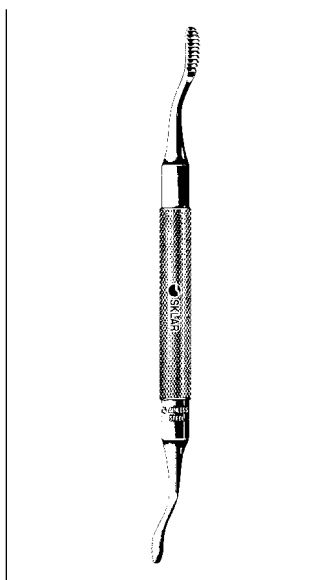
Double End

97-1635 8½" 5-6 mm



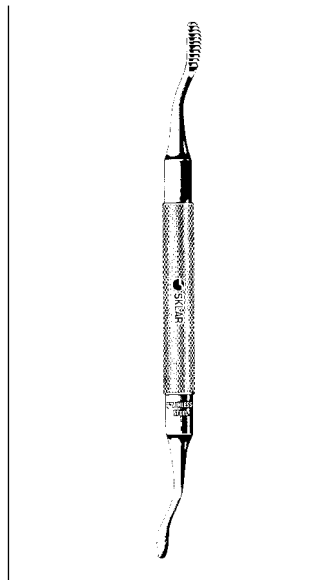
BONE FILE

Double End
97-1615 #10



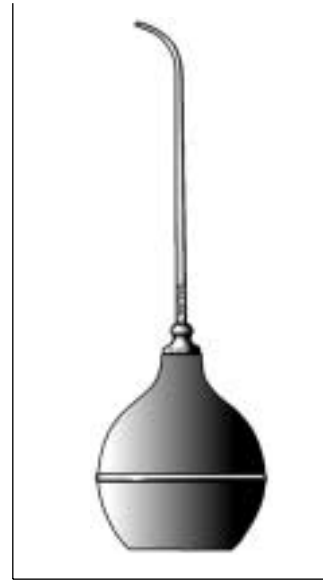
BONE FILE

Double End
97-1620 #12



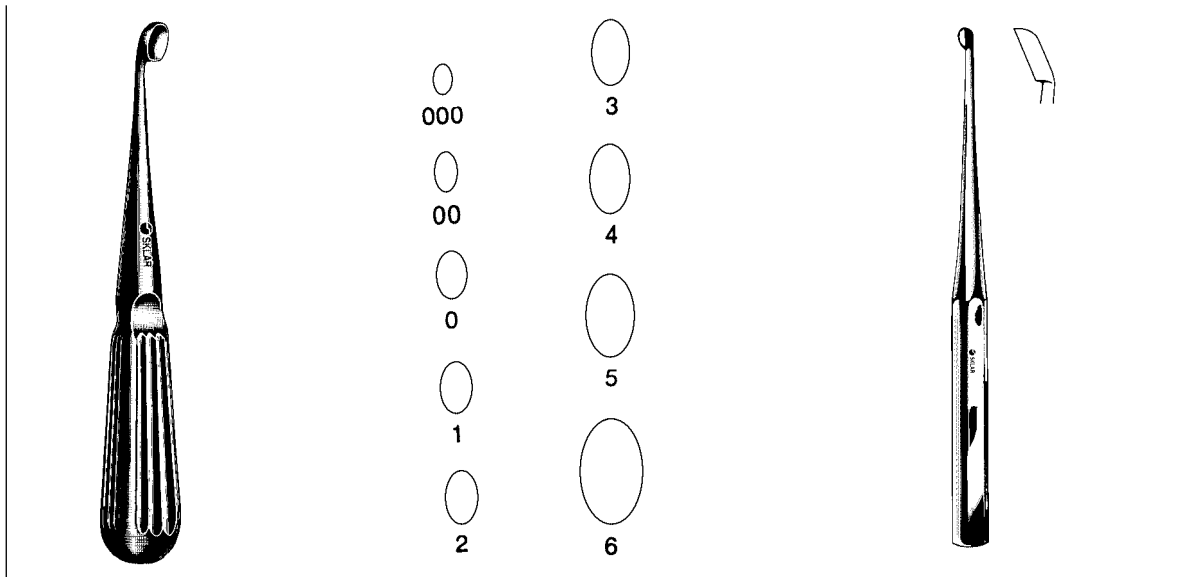
BONE FILE

Double End
97-1625 #12A



CHIP BLOWER

97-1650 Chip Blower Complete
97-1652 Tip Only
97-1654 Bulb Only



BRUNS CURETTE

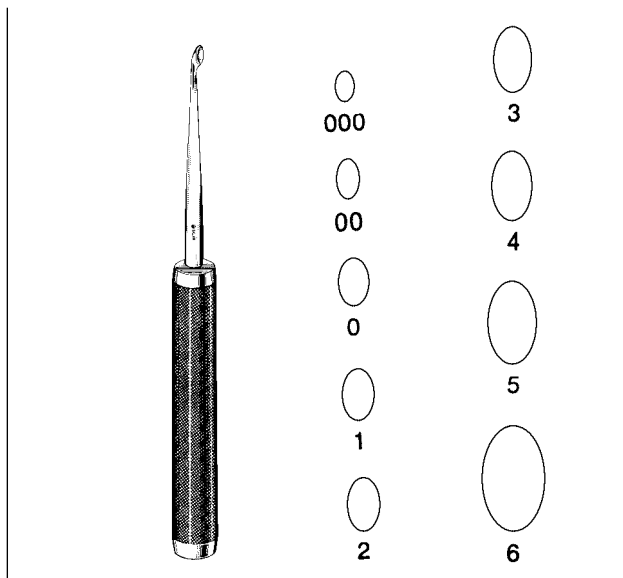
Single End-Oval 6 3/4"

- | | |
|--------------|------------|
| 40-7000 #3-0 | 40-7113 #3 |
| 40-7100 #2-0 | 40-7114 #4 |
| 40-7110 #1-0 | 40-7115 #5 |
| 40-7111 #1 | 40-7116 #6 |
| 40-7112 #2 | |

BRUNS CURETTE

Straight 9" with solid hexagonal handle

- | | |
|--------------|------------|
| 40-7330 #3-0 | 40-7335 #3 |
| 40-7331 #2-0 | 40-7336 #4 |
| 40-7332 #0 | 40-7337 #5 |
| 40-7333 #1 | 40-7338 #6 |
| 40-7334 #2 | |



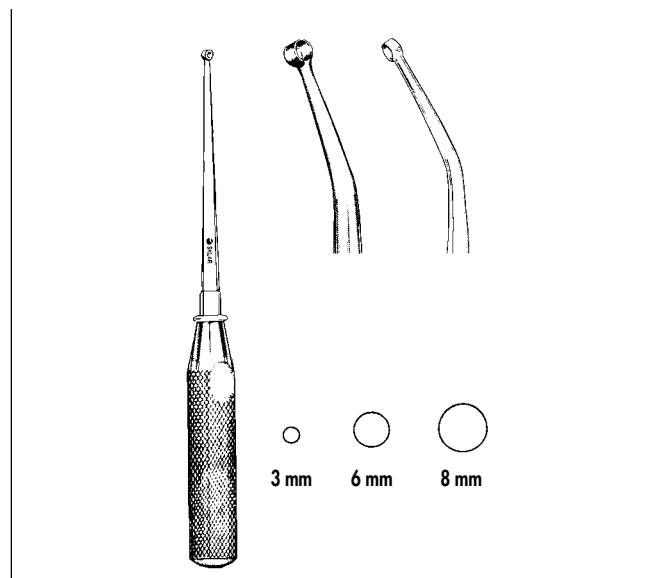
COBB STYLE BONE CURETTE

Straight 11" hollowed knurled handle, oval cup

- | | |
|--------------|------------|
| 40-8100 #3-0 | 40-8105 #3 |
| 40-8101 #2-0 | 40-8106 #4 |
| 40-8102 #0 | 40-8107 #5 |
| 40-8103 #1 | 40-8108 #6 |
| 40-8104 #2 | |

Angled 11" hollowed knurled handle, oval cup

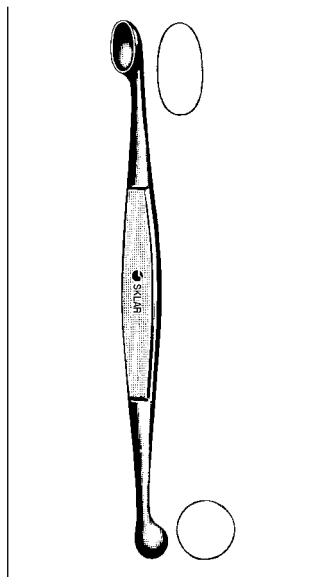
- | | |
|--------------|------------|
| 40-8110 #3-0 | 40-8115 #3 |
| 40-8111 #2-0 | 40-8116 #4 |
| 40-8112 #0 | 40-8117 #5 |
| 40-8113 #1 | 40-8118 #6 |
| 40-8114 #2 | |



CONE RING CURETTE

9"

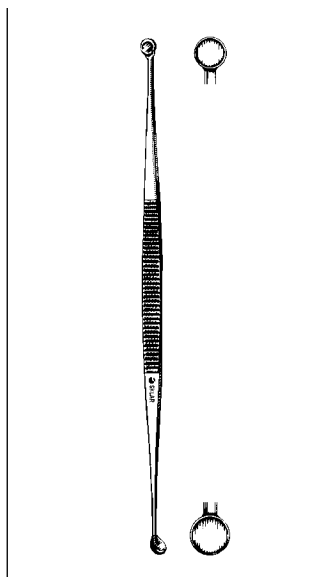
- | | | | |
|---------|----------|--------|---------------|
| 40-8130 | Straight | Size 1 | 8 mm Diameter |
| 40-8131 | Straight | Size 2 | 6 mm Diameter |
| 40-8132 | Straight | Size 3 | 3 mm Diameter |
| 40-8136 | Angular | Size 1 | 8 mm Diameter |
| 40-8137 | Angular | Size 2 | 6 mm Diameter |
| 40-8138 | Angular | Size 3 | 3 mm Diameter |



VOLKMAN CURETTE

Double End

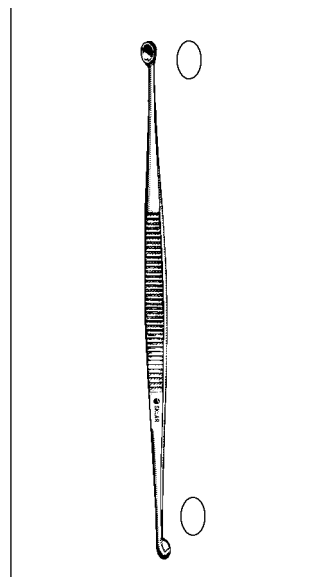
- 40-7250 5" Oval/Round
- 40-7265 6½" Oval/Round
- 40-7280 8" Oval/Round



MARTINI BONE CURETTE

Double End,

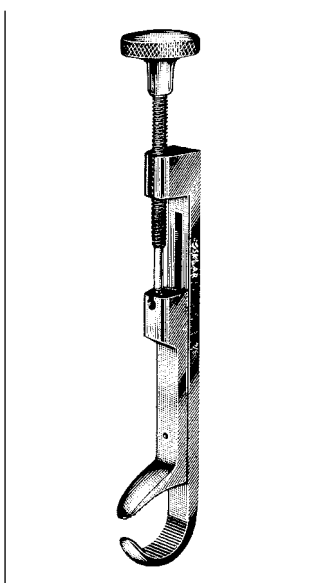
- 4 mm and 5 mm round cups
- 40-7284 5½"



WILLIGER BONE CURETTE

Double End,

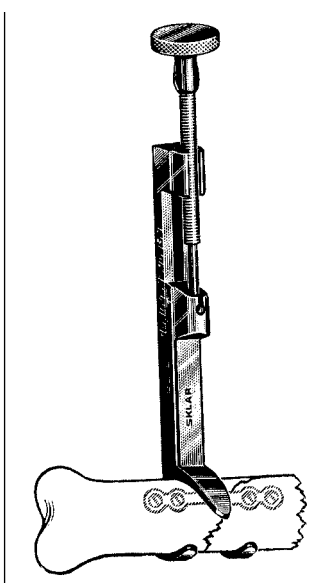
- 3 mm and 4 mm round cups
- 40-7286 5½"



LOWMAN CLAMP

1 x 1 Prongs

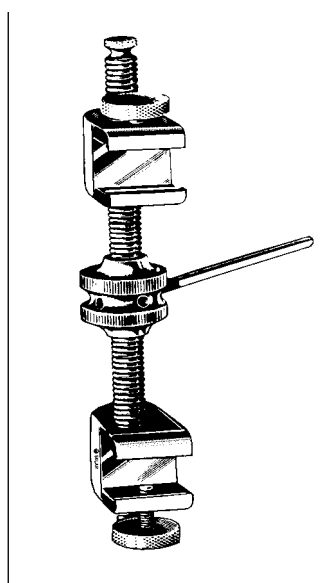
- 40-2925 4¾" x ¾" Jaw
- 40-2927 7¼" x 1½" Jaw
- 40-2928 8" x 1½" Jaw



LOWMAN CLAMP

1 x 2 Prongs

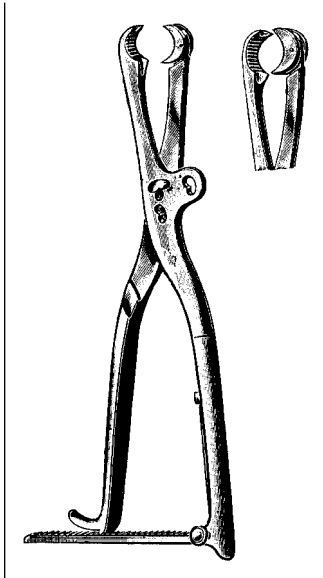
- 40-2921 4¾" x ¾" Jaw
- 40-2922 7¼" x 1½" Jaw
- 40-2923 8" x 1½" Jaw



GERSTER TURNBUCKLE

For Lowman and Lambert-Lowman Clamps

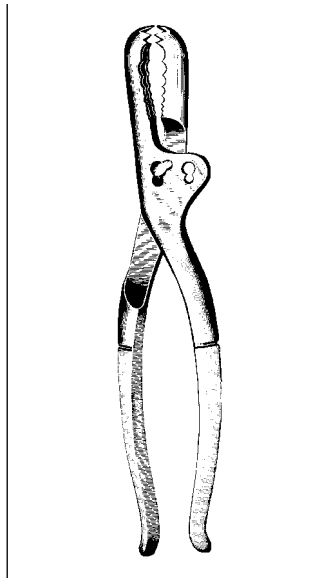
- 40-2780 Used in conjunction with bone holding forceps to approximate and temporarily immobilize bone pending surgical fixation.



LAMBOTTE BONE HOLDING FORCEPS

Double Articulation

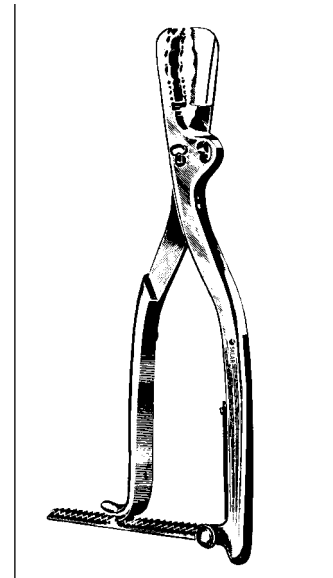
- 40-2820 8"
- 40-2830 10½"
- 40-2835 12½"



FARAFEUF BONE FORCEPS

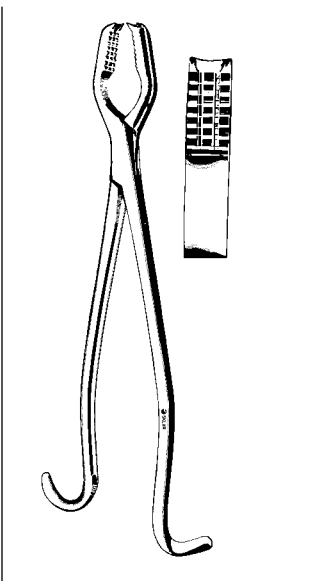
Double Articulation

- 40-2710 10½"



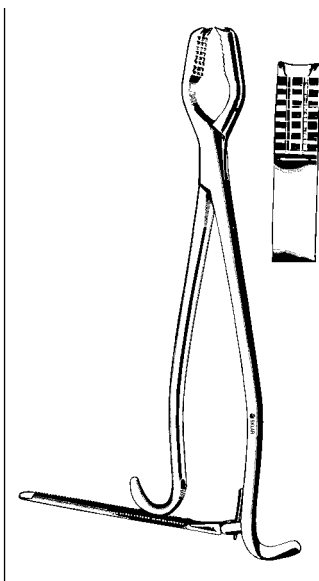
FARABEUF-LAMBOTTE BONE HOLDING FORCEPS

- 40-2810 10½"



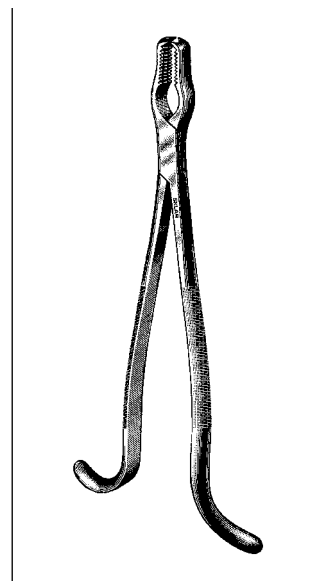
LANE BONE HOLDING FORCEPS

- 40-2313 13"
- 40-2417 17"



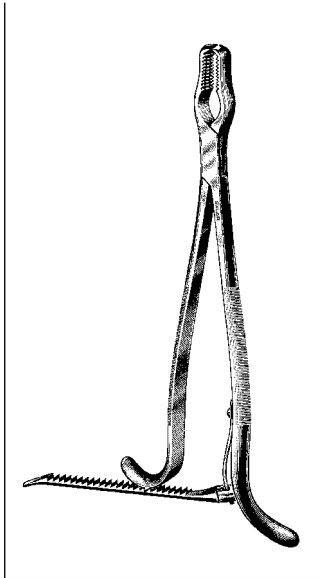
LANE BONE HOLDING FORCEPS

- With Ratchet
- 40-2413 13"
- 40-2418 17"



KERN BONE HOLDING FORCEPS

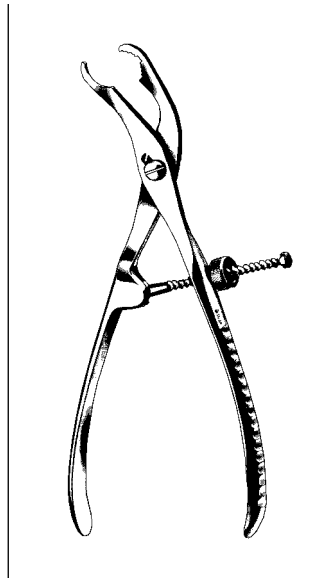
- Without Ratchet
- 40-2480 5½" Extra Small
- 40-2485 8½"



KERN BONE HOLDING FORCEPS

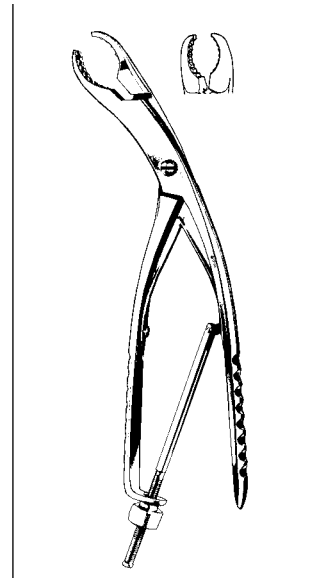
With Ratchet

40-2580 5½" Extra Small
40-2585 8½"



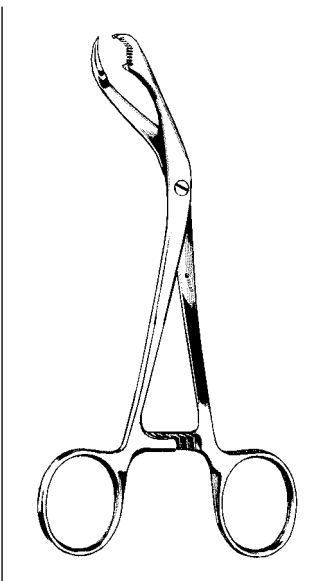
SELF-RETAINING BONE HOLDING FORCEPS

Angular with side lock
40-2590 6"



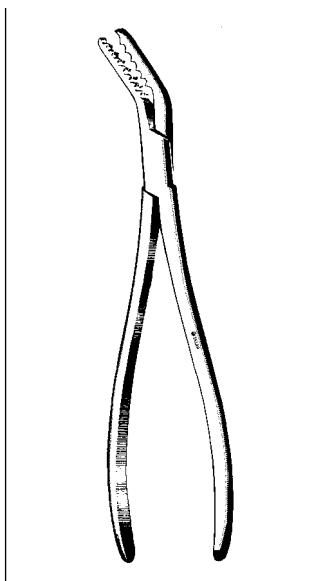
SELF-RETAINING BONE HOLDING FORCEPS

Angular with bottom lock
40-2595 5½"



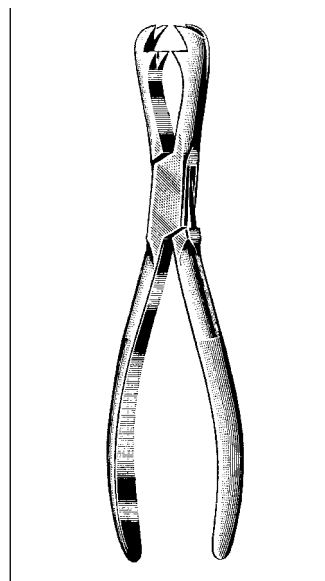
VERBRUGGE BONE HOLDING FORCEPS

40-2598 7"



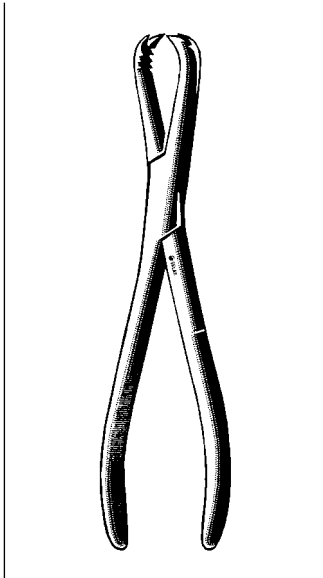
SEMB BONE HOLDING FORCEPS

40-2708 7½"



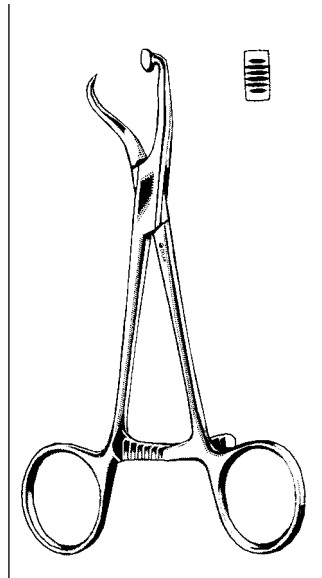
FERGUSON BONE HOLDING FORCEPS

40-2285 8½"



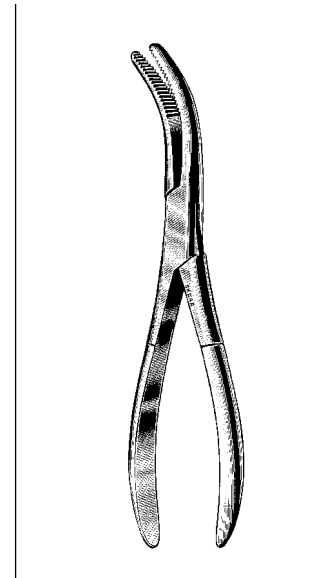
**LAGENBECK BONE
HOLDING FORCEPS**

40-2705 8"



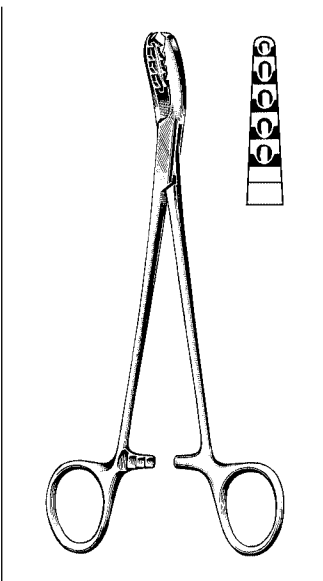
**PLATE AND BONE
HOLDING FORCEPS**

One pointed tip and foot plate
40-2672 4 3/4"



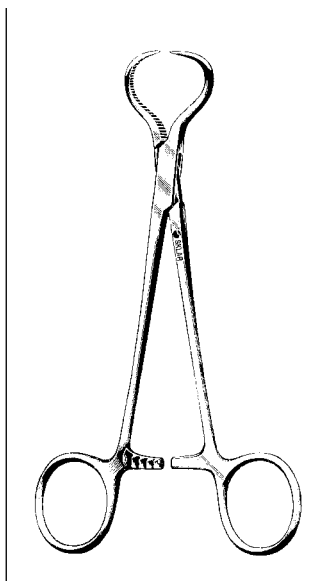
**VAN BUREN
SEQUESTRUM FORCEPS**

40-2085 8 1/2" Curved
40-2185 8 1/2" Angular



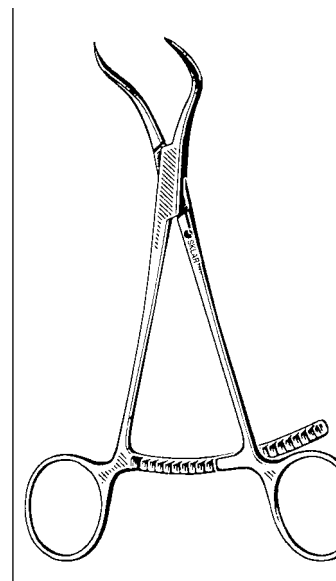
**BONE AND CARTILAGE
CLAMP**

40-2275 8" Curved



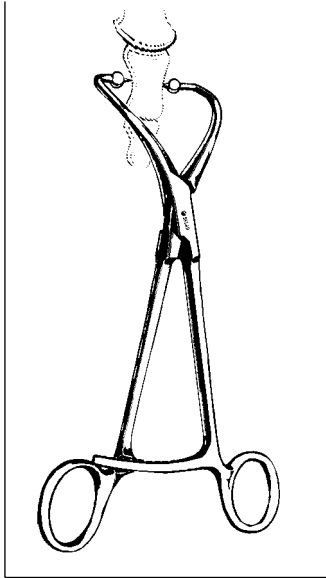
LEWIN BONE FORCEPS

40-2670 7" Serrated



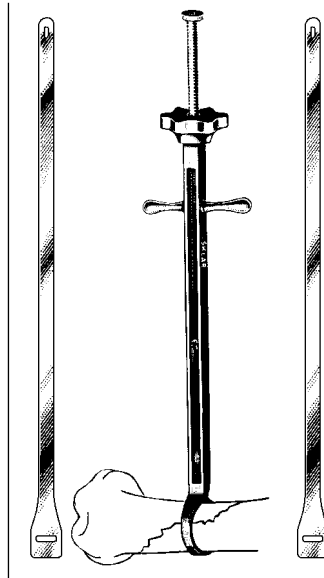
**BONE COMPRESSION
FORCEPS**

40-2675 5 1/2" Pointed Tip



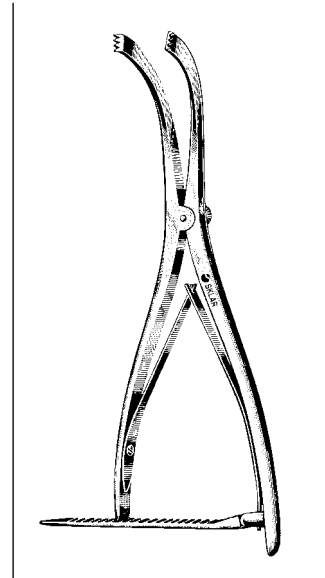
TUCKER HALLUX FORCEPS

40-2678 4½" Ball guarded points



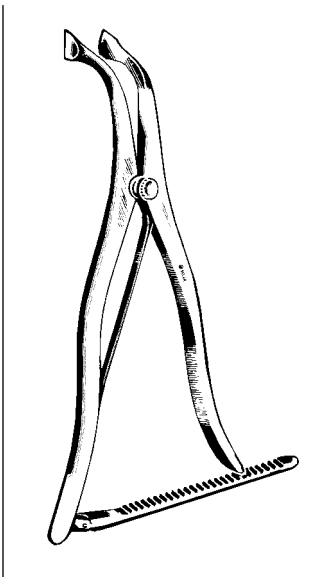
PARHAM-MARTIN BONE CLAMP

With two bands
40-1780 Complete
40-1781 Bands Only



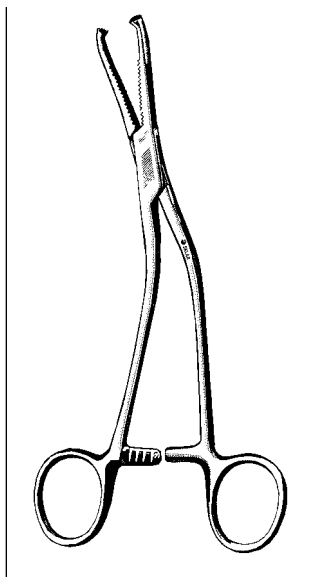
INGE RETRACTOR

42-1420 6½"
42-1425 10½"



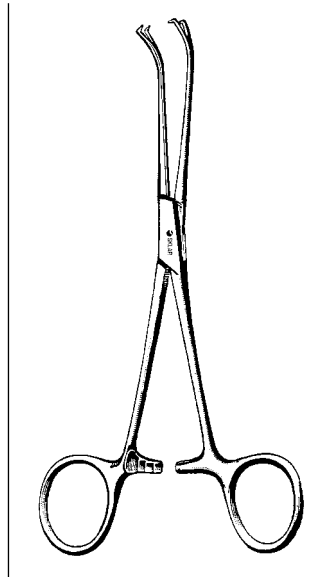
LAMINA SPREADER

Flat Blades
42-1422 10½"
Maximum opening 2"



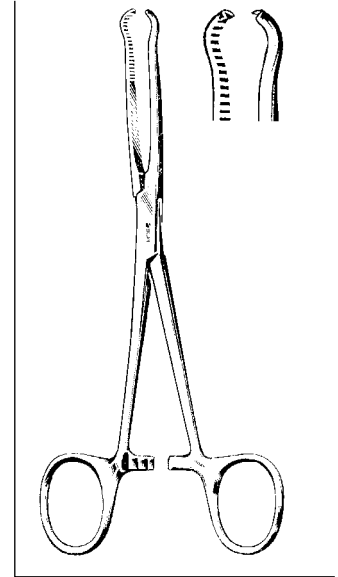
DINGMAN SMALL BONE AND CARTILAGE CLAMP

40-2660 7½" Serrated jaws, 4 mm
2 x 2 teeth



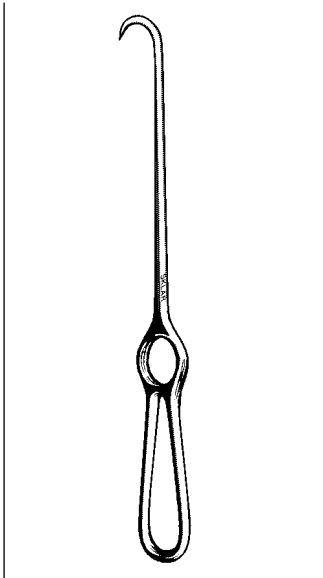
SESAMOID CLAMP

40-2655

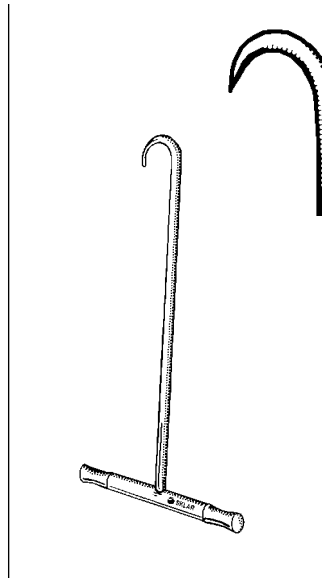


LOCKE PHALANGEAL FORCEPS

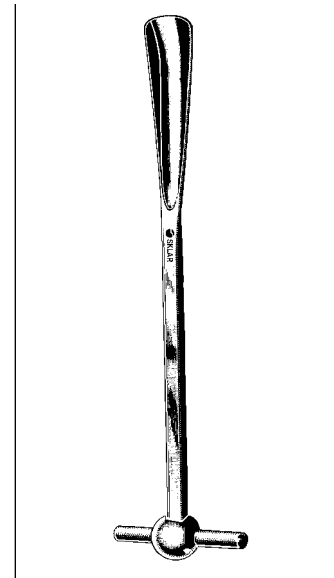
40-2650 6"



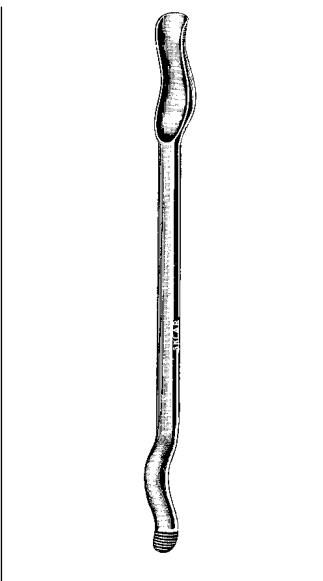
VOLKMAN BONE HOOK
60-5820 8" Sharp 1½" Deep



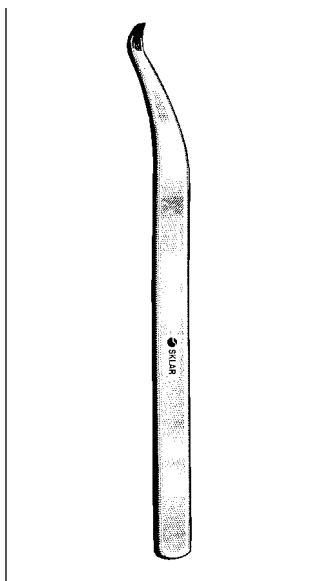
BONE HOOK
Large "T" Handle
40-6855



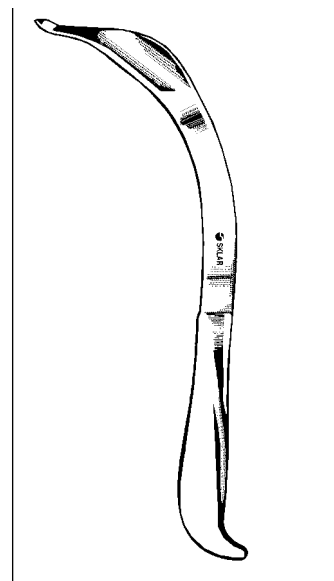
MEYERDING SKID
40-6914 13½"



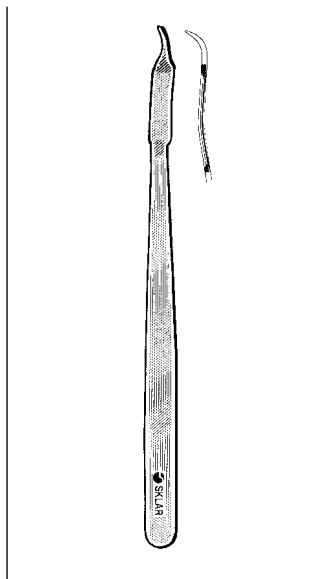
MURPHY-LANE BONE SKID
40-9613 13"



HAYS HAND AND FINGER RETRACTOR
40-8265 1½" Long
¾" wide tapering to ¼"

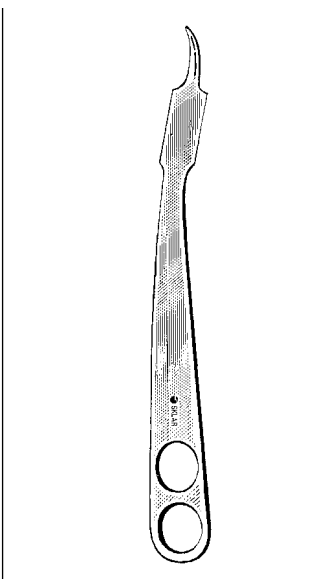


AUFRANC COBRA RETRACTOR
40-8280 Pointed tip, serrated
40-8282 Blunt tip, serrated
40-8284 Blunt tip, smooth



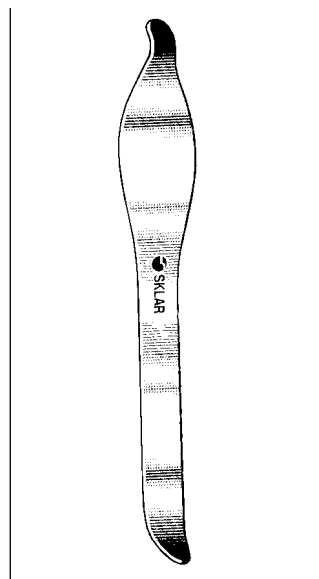
MINI HOHMANN BONE ELEVATOR

40-7450 6½" x 6 mm
40-7451 6½" x 8 mm



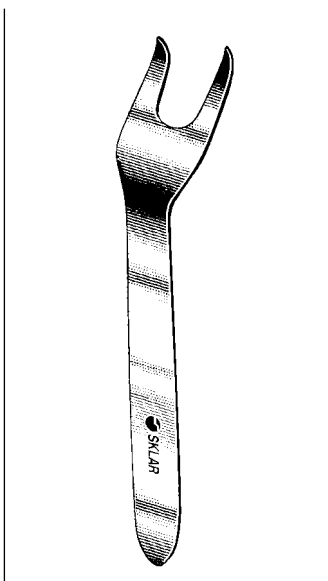
HOHMANN BONE ELEVATOR

40-7452 9" x 18 mm
40-7453 9½" x 43 mm
40-7454 9½" x 24 mm
40-7455 9½" x 20 mm



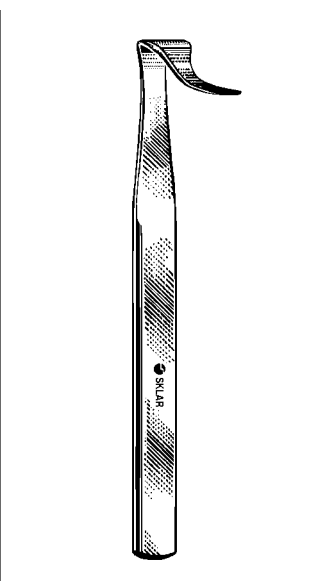
BLOUNT SINGLE PRONG RETRACTOR

40-8252 10½" 37 mm blade width



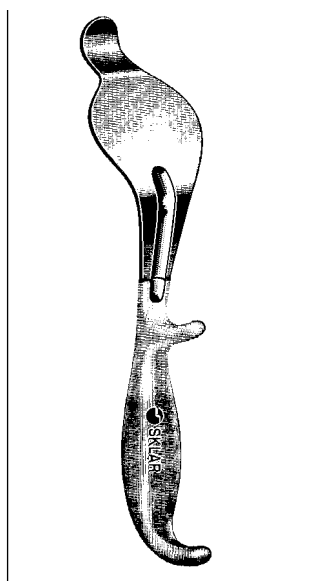
BLOUNT DOUBLE PRONG RETRACTOR

40-8255 10½" 44 mm width



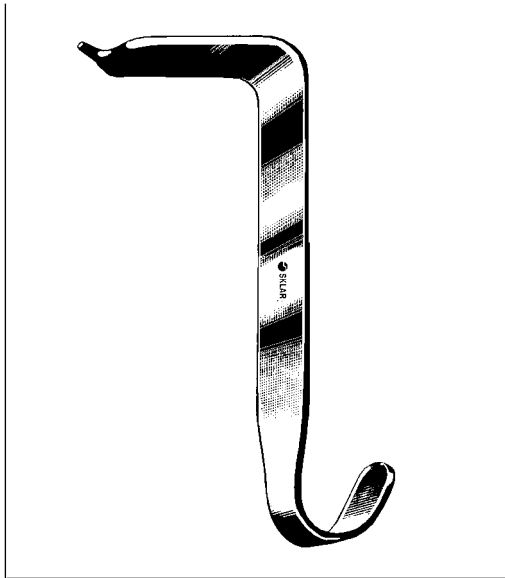
BLOUNT KNEE RETRACTOR

40-8250 7" Blade 1¾" deep, ¾" wide tapering to ¼"



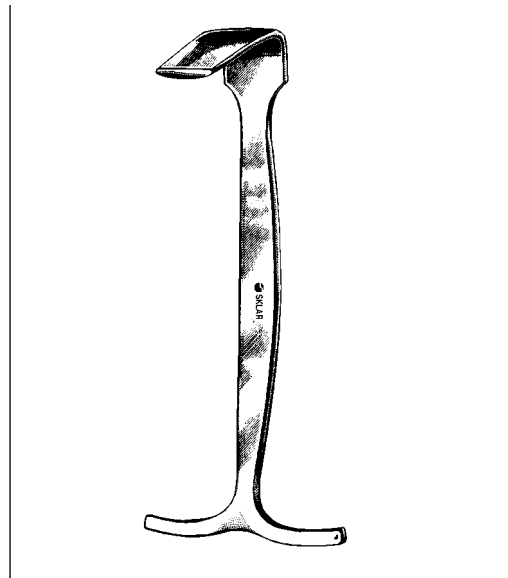
BENNETT TIBIA RETRACTOR

9½"
40-8175 1¾" (4.4 cm) Small
40-8238 2½" (6.4 cm) Large



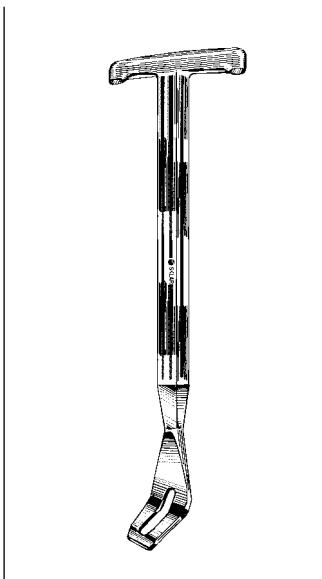
**TAYLOR SPINAL
RETRACTOR**

42-2130 3" (7.6 cm) Small Blade
42-2140 4" (10.2 cm) Large Blade



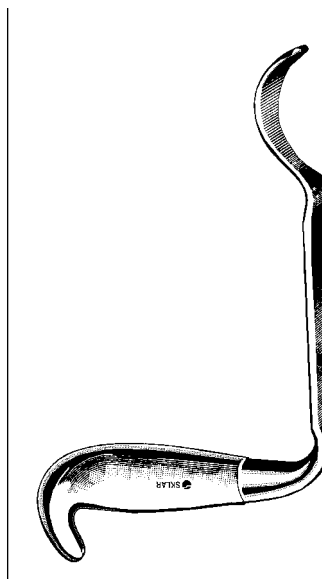
**SMILLE MENISCUS HOOK
RETRACTOR**

40-2290 5 3/4" Long Blade 3/4" x 1 1/8"



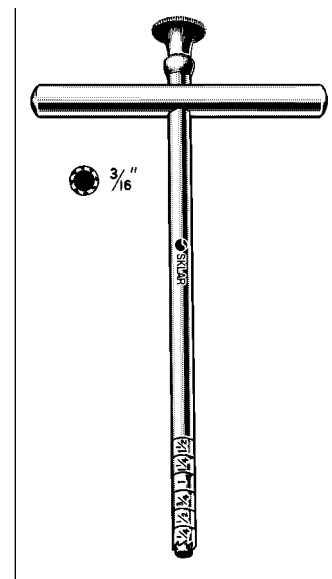
**GLENOID FOSSA
RETRACTOR**

40-2295



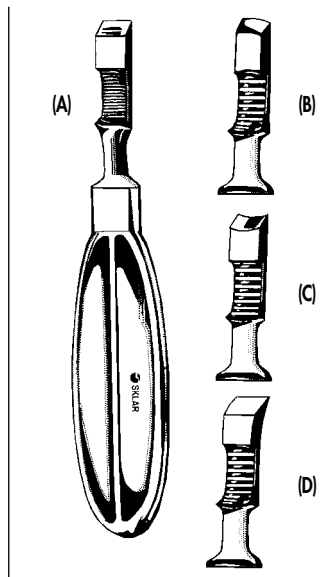
MOORE BONE RETRACTOR

40-8360



**P.I. PLUG CUTTER WITH
OBTURATOR**

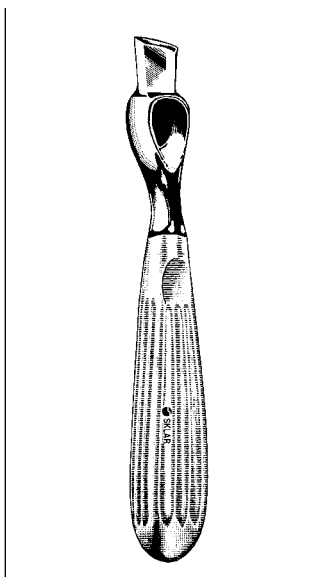
42-2701 3/8"



MATHIEU RASPATORIES

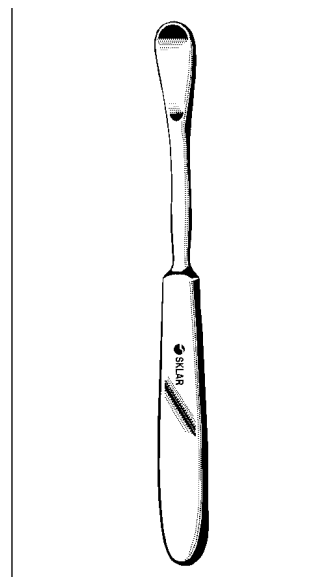
6 1/4"

- 40-8862 Str. with Str. Edge (A)
- 40-8962 Str. with Convex Edge (B)
- 40-8964 Str. with Concave Edge (C)
- 40-8966 Curved with Str. Edge (D)



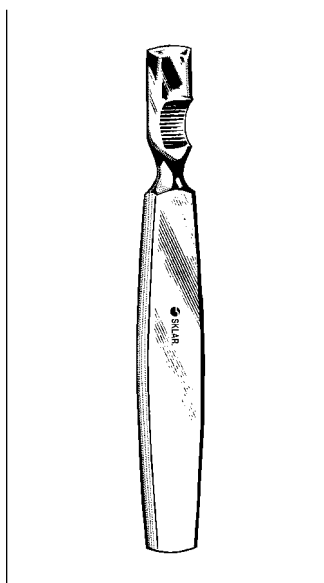
KIRMISSION PERIOSTEAL RASPATORY

40-9070 6 3/4" Sharp



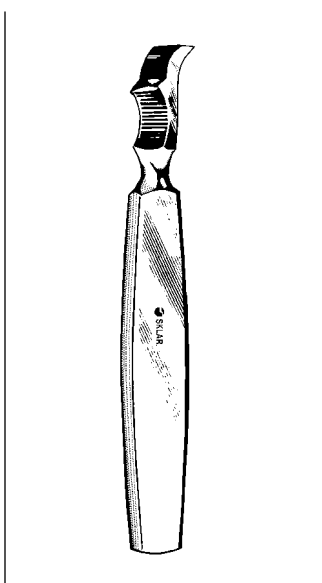
SEDILLOT ELEVATOR

40-7456 7 1/2"



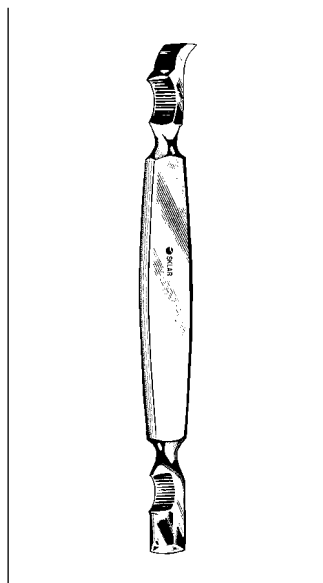
FARABEU RASPATORY

40-9160 6 1/4" (15.5 cm) Straight



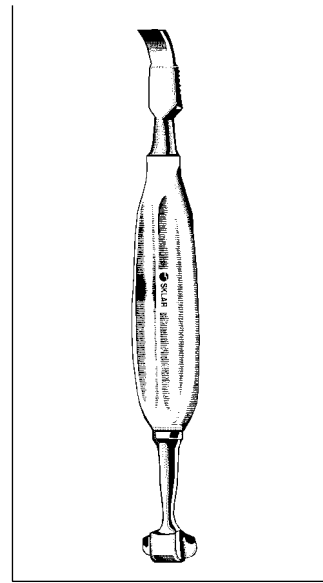
FARABEU RASPATORY

40-9260 6 1/4" (15.5 cm) Curved



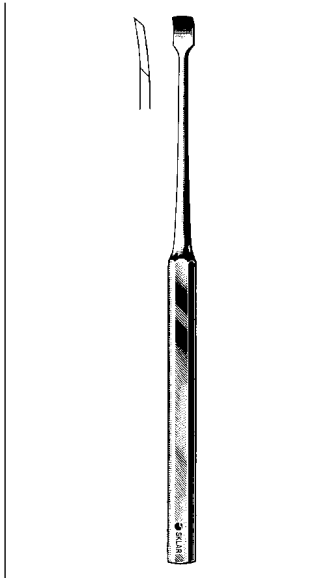
FARABEU RASPATORY

40-9075 7 1/2" (19 cm) Double Ended



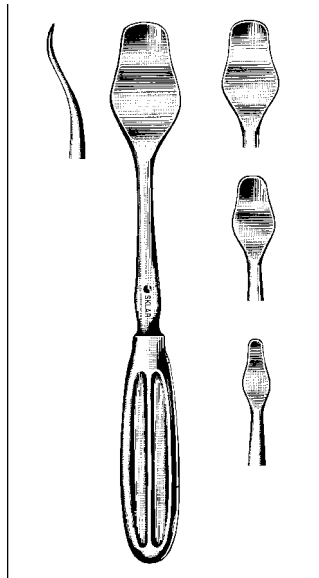
ALEXANDER COSTAL PERIOSTEOTOME

55-5980 8" (20.3 cm)



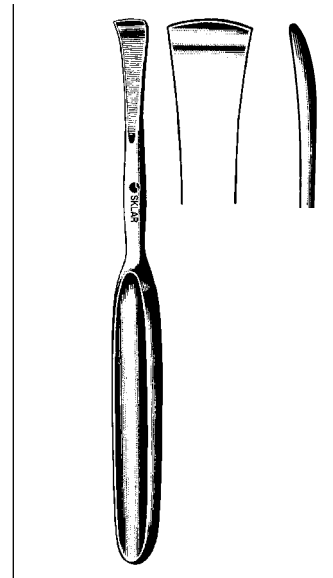
KEY ELEVATOR

40-7400 7½" x ¼"
 40-7402 7½" x ½"
 40-7404 7½" x ¾"
 40-7406 7½" x 1"



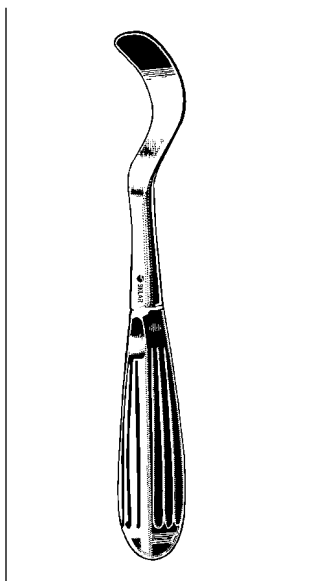
CHANDLER ELEVATOR

40-7430 7"
 40-7435 8"
 40-7440 9"
 40-7445 10"



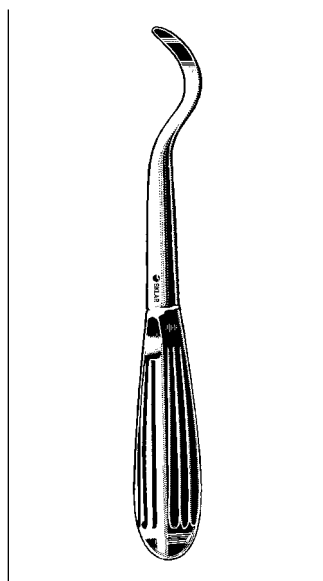
LANGENBECK ELEVATOR

Single End
 40-8675 7½" Narrow
 40-8775 7½" Broad



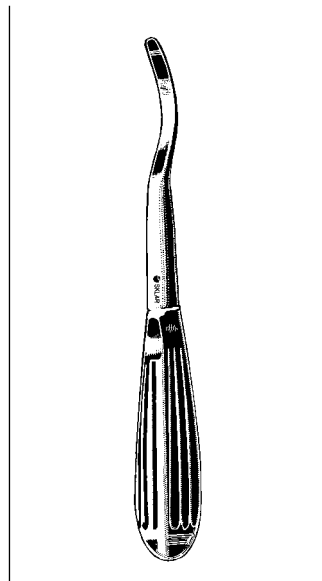
CREGO ELEVATOR

Full Curve
 40-7410 7¼" Long x ⅝" Wide



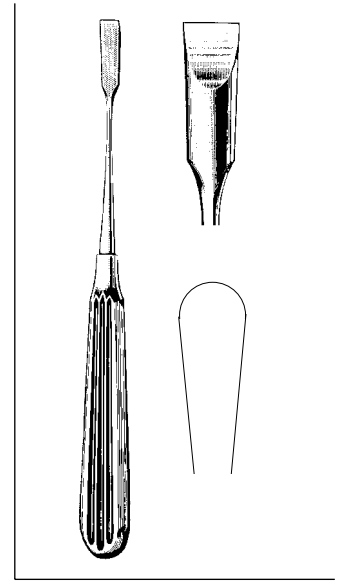
CREGO ELEVATOR

Full Curve
 40-7415 7¾" Long x ¼" Wide



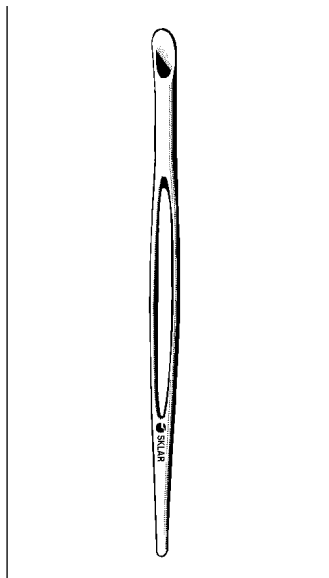
CREGO ELEVATOR

Slight Curve
 40-7420 7¾" Long x ¼" Wide



ADSON ELEVATOR

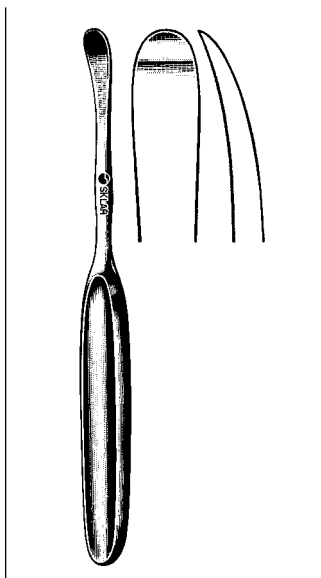
40-8270 6¾" Square End
 40-8272 6¾" Round End



SAYRE ELEVATOR

Double End

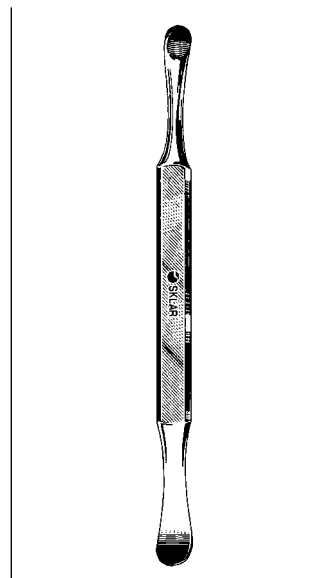
40-9265 6½" (16 cm) Sharp
40-9365 6½" (16 cm) Blunt



LANE ELEVATOR

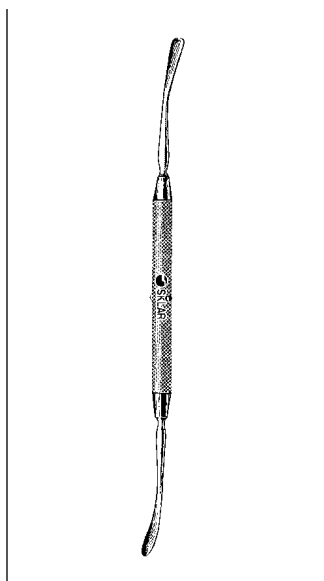
Single End

40-8375 7½" Narrow
40-8275 7½" Wide



SELDIN ELEVATOR

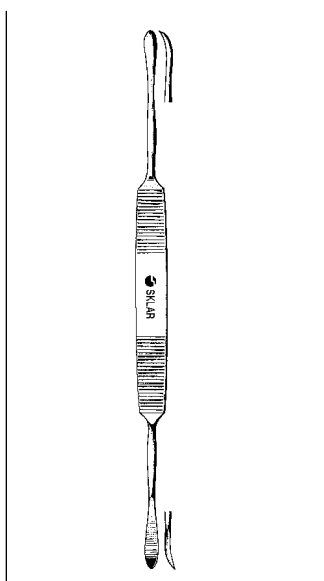
97-0527 7" Double End



FREER ELEVATOR

Double End

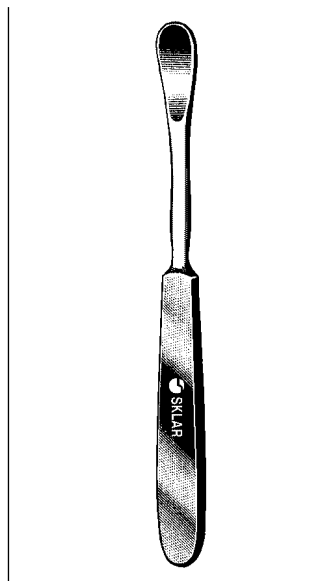
47-2380 7¼" S/B



OHL ELEVATOR

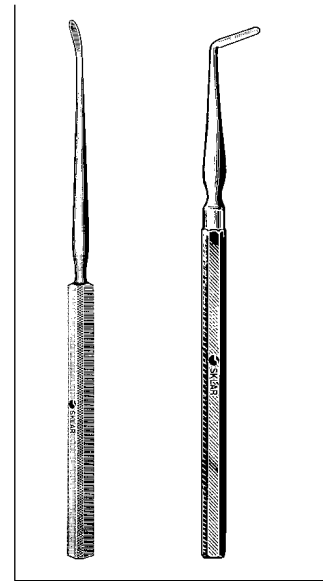
Double End

97-0050



SEDILLOT PERIOSTEAL ELEVATOR

40-9370 7" 16 mm sharp

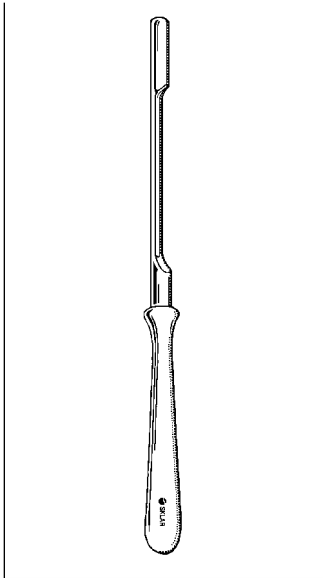


FRAZIER BLUNT DISSECTOR

47-2360 6" Angular

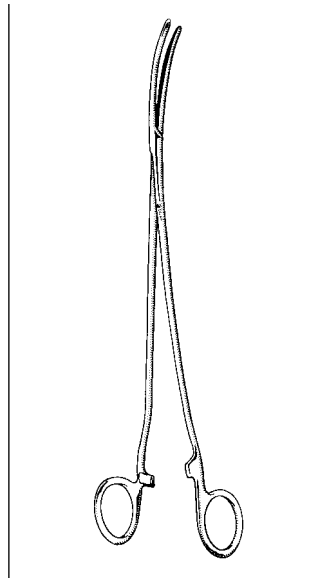
WEST BLUNT DISSECTOR

47-2262 6¼" Curved



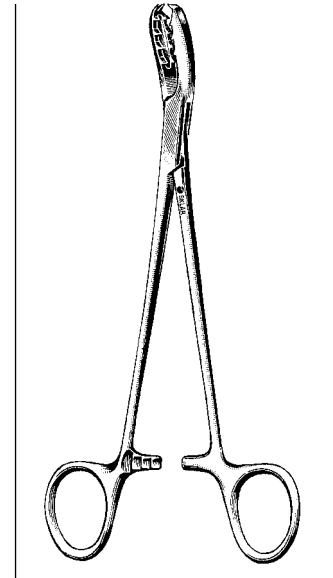
BUNNELL TENDON STRIPPERS

- 47-3401 3 mm internal diameter
222 mm (8 7/8") long handle
- 47-3402 4 mm internal diameter
222 mm (8 7/8") long handle



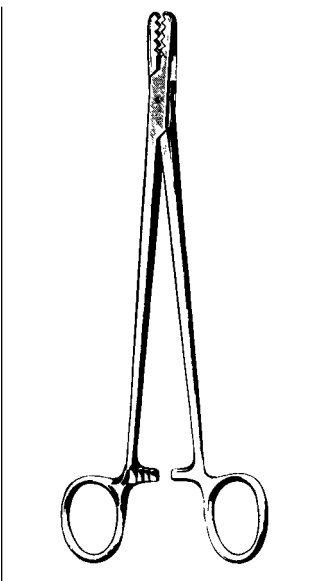
PLATT TENDON TRANSPLANTATION FORCEPS

- 47-3510 11" 279 mm
Stainless Steel



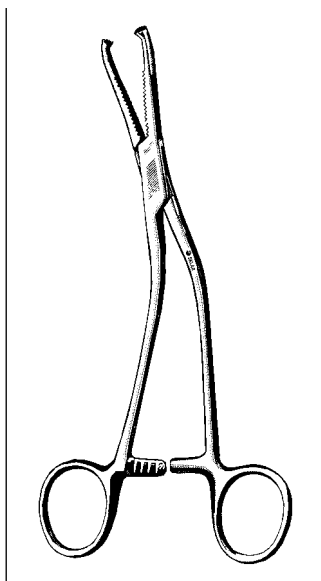
BONE AND CARTILAGE CLAMP

- 40-2275 8" Curved



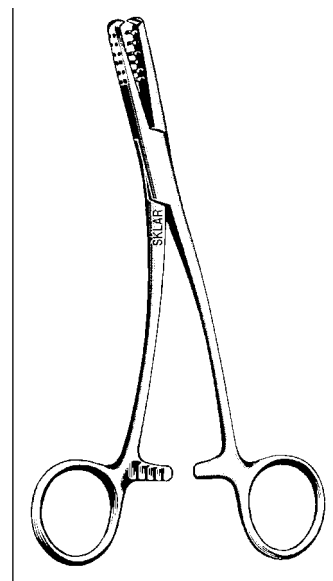
SKLAR TENDON CLAMP

- Improved Pattern
- 41-1140 8"



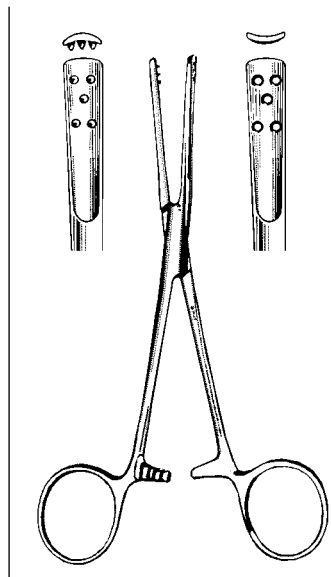
DINGMANN SMALL BONE AND CARTILAGE CLAMP

- 40-2660 7 1/2" Serrated jaws 4 mm
2 x 2 teeth



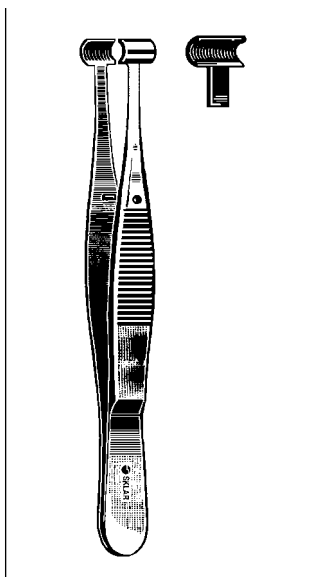
SKLAR MENISCUS CLAMP

- With Pins
- 40-2276 7 1/2" (19.1 cm)
Shanks curved sideways



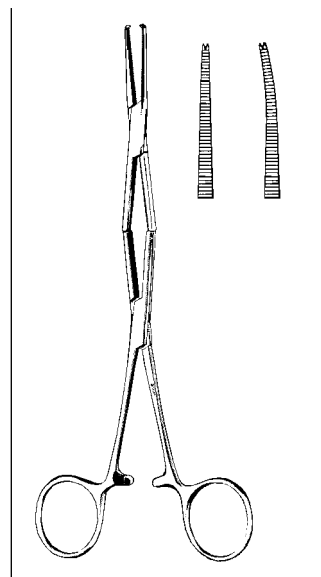
PENNER FORCEPS

Double End
97-1325 5 1/4"



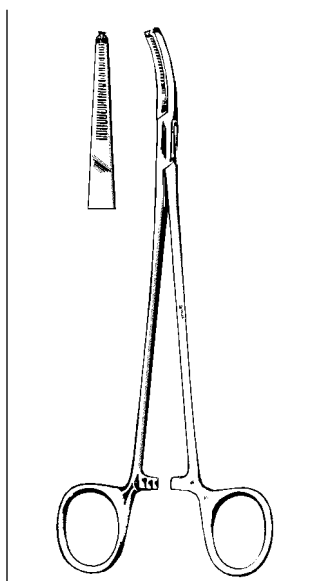
LARSEN TENDON FORCEPS

47-3502 4" 2 mm
47-3503 4" 3 mm
47-3504 4" 4 mm
47-3505 4" 5 mm



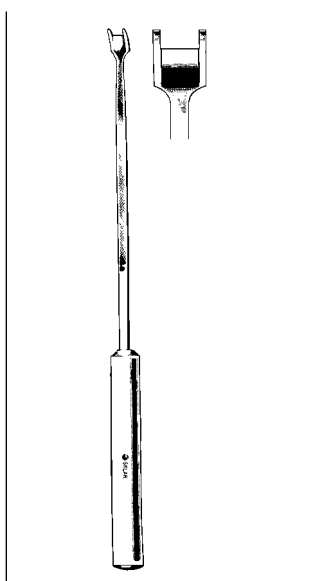
BUCK-GRAMCKO TENDON RETRIEVER

Double Action, Serrated Jaws
2 x 3 Teeth
40-2640 8" Straight
40-2642 8" Curved



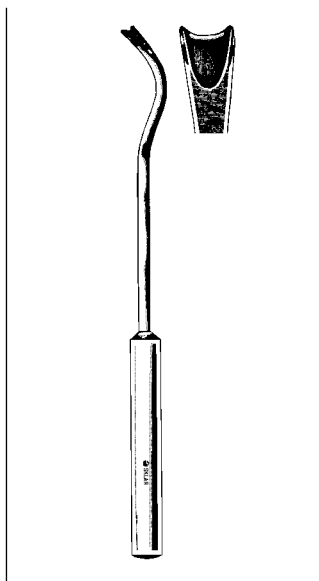
PRESTON LIGAMENTUM FLAVUM FORCEPS

40-2665 7"



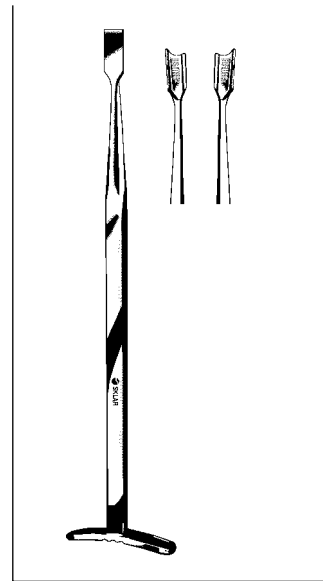
LOWE-BRECK CARTILAGE KNIFE

Straight edge with guards
47-3418 10 1/2"



DOWNING CARTILAGE KNIFE

Concave edge with guards
47-3415 10"



SMILLIE MENISCUS KNIVES

47-3420 7 1/2" Straight Chisel Blade
47-3422 7" Guarded Left
47-3424 7" Guarded Right

TENDON STRIPPER

Lightweight, Autoclavable Handle

47-3290 11" 3 mm Inner Diameter

47-3292 11" 5 mm Inner Diameter

47-3294 20" 5 mm Inner Diameter



TENDON PASSER WITH OLIVE AND EYE

Lightweight, Autoclavable Handle

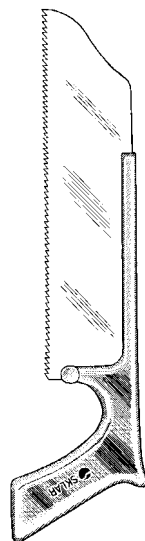
11" (28 cm)

47-3298 7 mm



TENDON PASSING PROBE WITH EYE AND GROOVE

47-3285 8"



SATTERLEE BONE SAW

40-5311 12"

40-5312 Blade Only



CHARRIERE METACARPAL BONE SAW

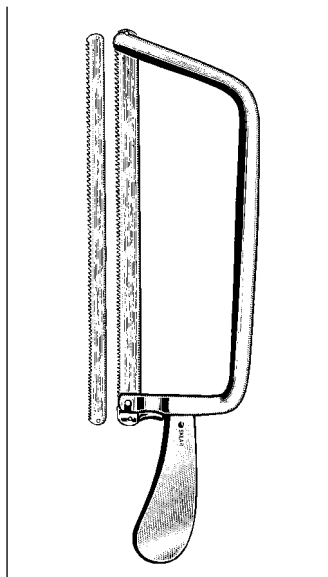
40-5210 11 1/2" 8" Blade
Chrome plated



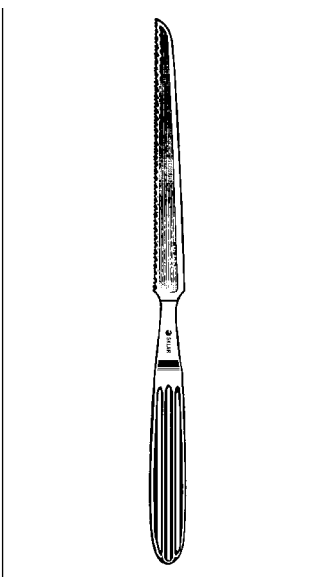
JOSEPH BONE SAW

Bayonet
70-7801 Right
70-7802 Left

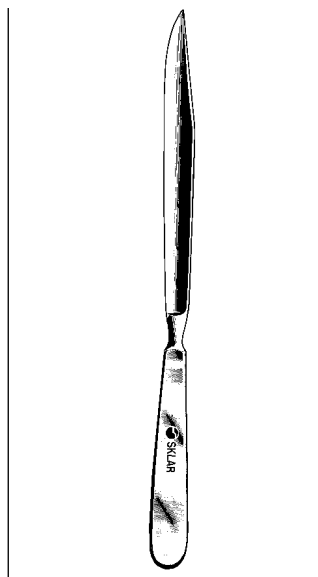
Straight
70-7805



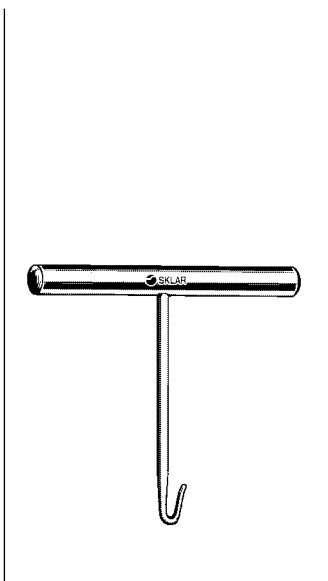
ASEPTIC SAW
 With Bow Handle
 40-5213 Two 7" (17.8 cm) blades
 Total length 13½"
 (34.3 cm)



LANGENBECK METACARPAL SAW
 40-5395 4½" (11.4 cm) blade
 Total length 9½"
 (24.1 cm)



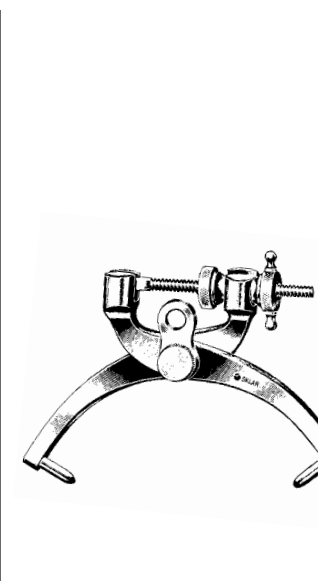
LISTON AMPUTATING KNIFE
 12-1065 6½"



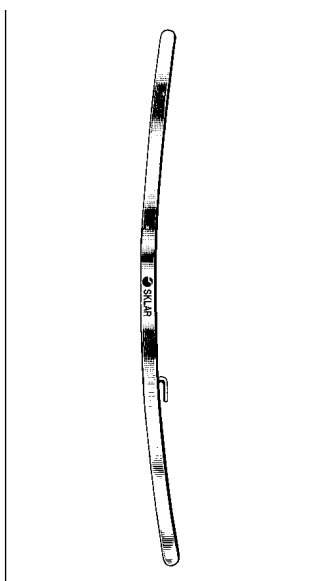
GIGLI SAW HANDLES
 40-5520 Solid Style
 40-5535 Wire Loop Style (Not Shown)

GIGLI SAW WIRES

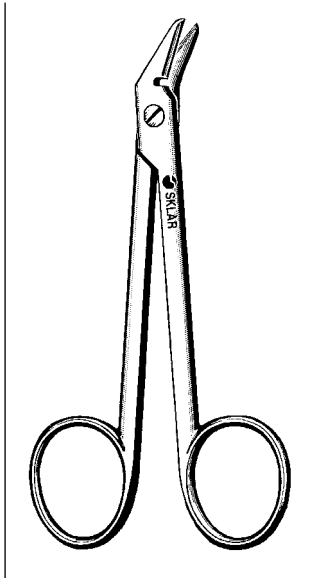
- 40-5540 9"
- 40-5542 12"
- 40-5544 20"
- 40-5546 30"



CRUTCHFIELD TONGS
 50-2585 4½" With two drills
 50-2586 Drill points only
 for Crutchfield Tongs
 Set of 2 (1 Large, 1 Small)

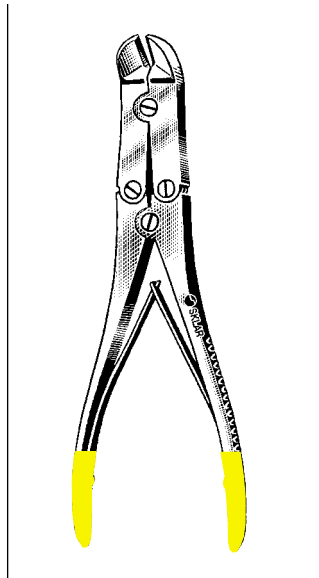


BAILEY GIGLI SAW GUIDE
 50-2412



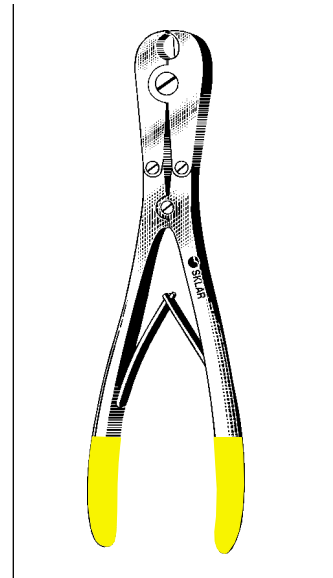
**SUTURE WIRE CUTTING
SCISSORS**

Angular Serrated
24-2342 4 3/4"
16-2800 4 3/4" T-C



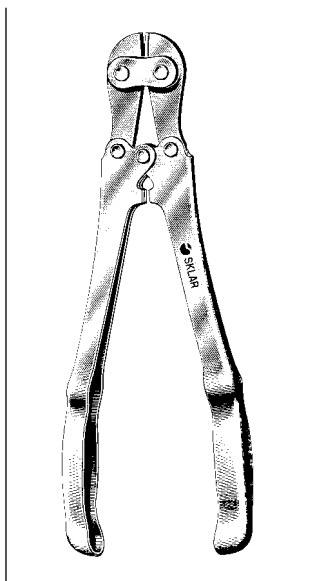
**T-C PIN CUTTER SIDE
CUT**

Double Action
40-1023 7" Straight
40-1024 8 1/2" Angular



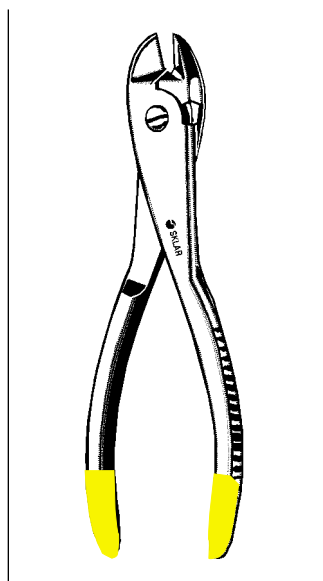
T-C PIN CUTTER

Double Action
Cuts to .062" Wire (16 cm)
40-1045 7" End Cut-Side Cut



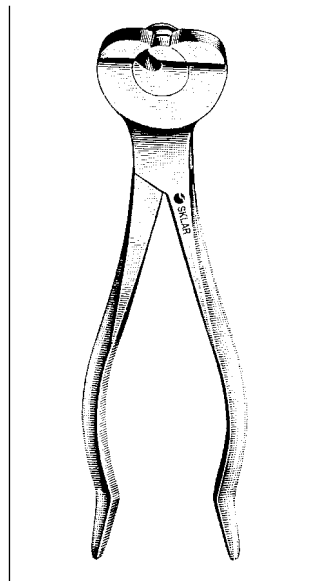
**DOUBLE ACTION PIN
CUTTER**

Chrome
40-1715 15" Cuts up to 3/32"
40-1716 Replaceable Blades



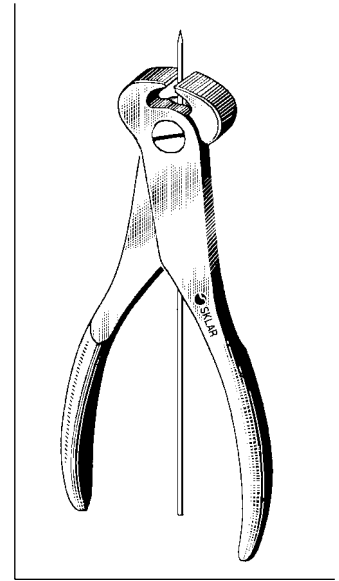
**T-C WIRE AND PIN
CUTTER**

40-1018 8"



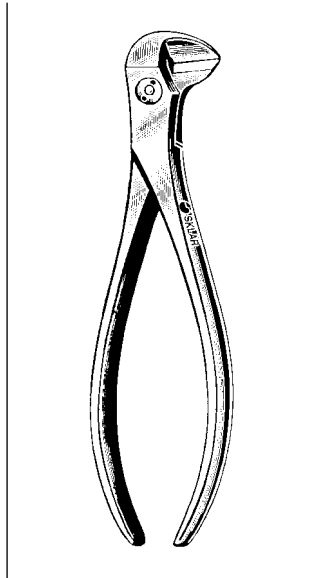
DIAMOND PIN CUTTER

Chrome
40-1762 6 1/4"

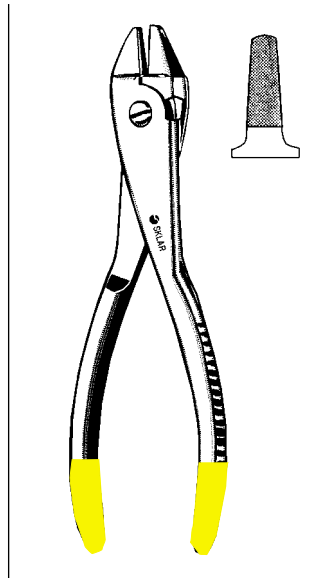


SKLAR PIN CUTTER

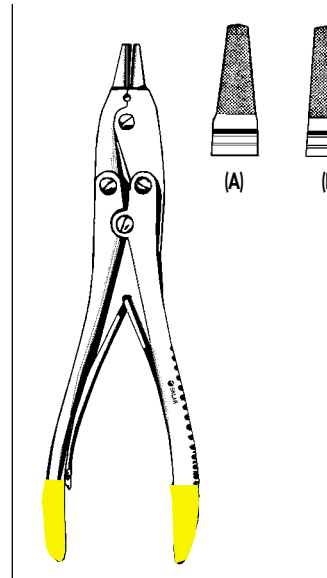
End Cutting
40-1048 Cannulated



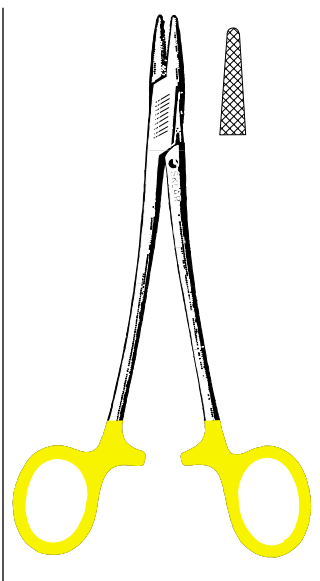
IMPROVED FORCEPS
For Cutting and Shaping Wire
75-9550



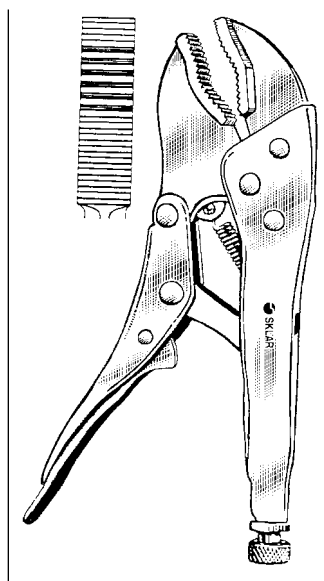
T-C WIRE PULLER
40-1730 8"



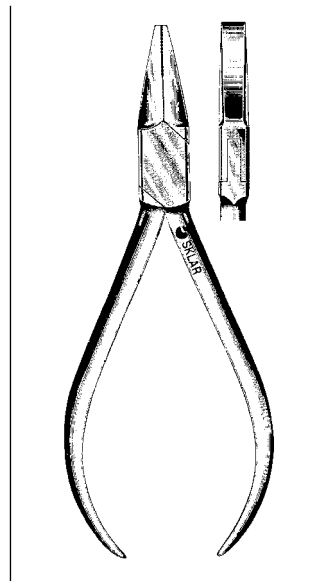
T-C WIRE PULLER
Double Action
40-1735 7" 4 mm (A)
40-1738 7" 6 mm (B)



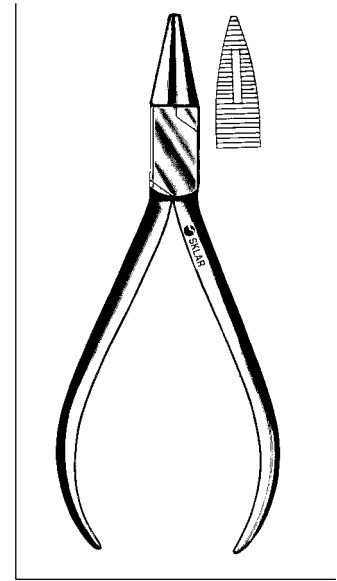
T-C RING HANDLE WIRE EXTRACTOR
40-1720 Tungsten Carbide



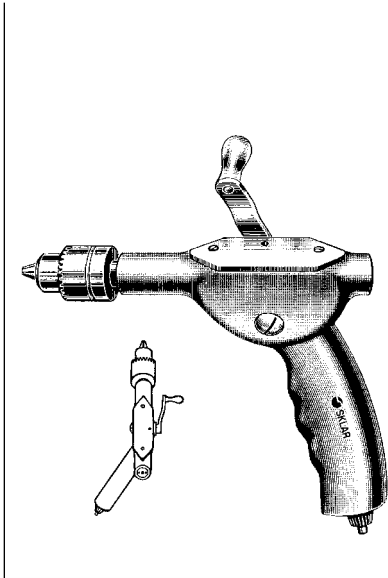
SNAP LOCK PIN/WIRE EXTRACTOR
40-1725



SQUARE END PLIERS
40-1778 5½"

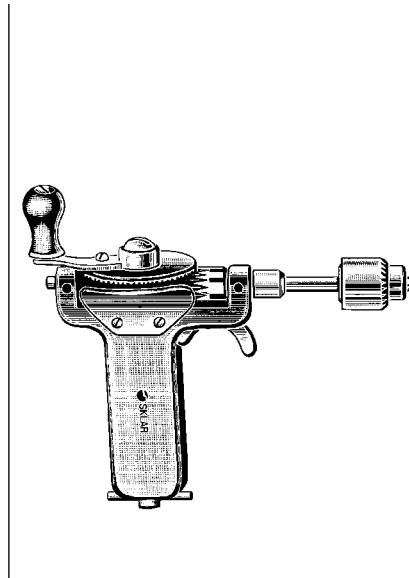


NEEDLE NOSE PLIERS
40-1775 5½"



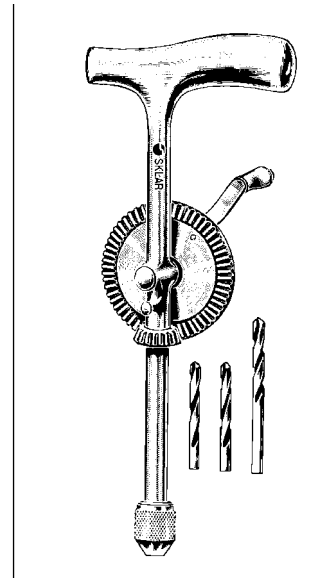
**SKLAR BONE
DRILL-OFFSET HANDLE**

With Jacobs Chuck
 40-1465 For Twist Drills and
 Kirschner Wires
 40-1478 Chuck Key Only



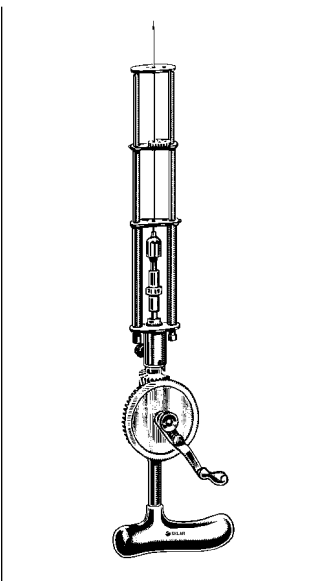
**BUNNELL
DRILL-CANNULATED**

With Jacobs Chuck
 40-1475 For Twist Drills and
 Kirschner Wires
 40-1478 Chuck Key Only



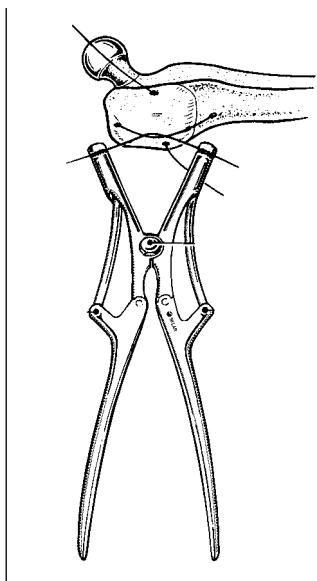
MOORE DRILL

With 3 Drill Points
 40-1010 Complete
 40-1012 Drill Points only



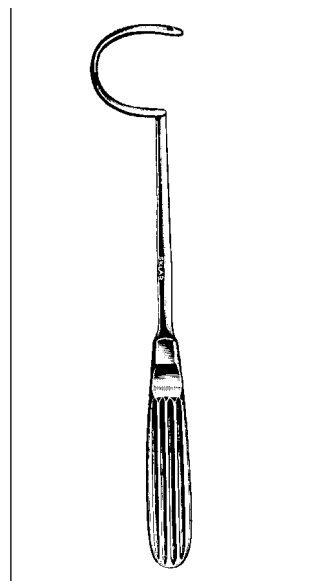
**KIRSCHNER BONE
DRILL**

40-1520 Without Drills



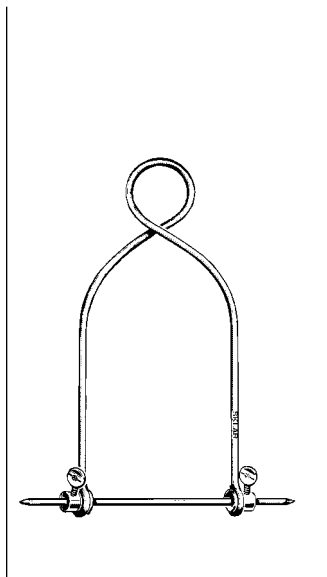
**HARRIS WIRE KNOT
TIGHTENER**

40-1530 10" (254 mm)
 Suitable for 18 and 20
 gauge wire



BORCHARD WIRE GUIDE

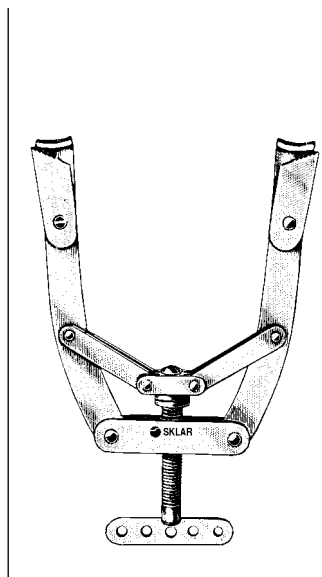
40-1771 1 3/4" Diameter



BOHLER TRACTION BOW

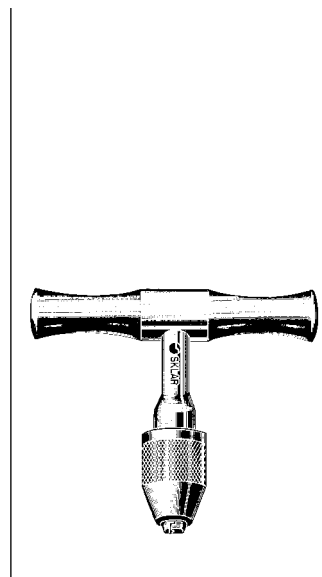
For Steinmann Pins

40-1765 3" x 5" Small
40-1766 4" x 8½" Large



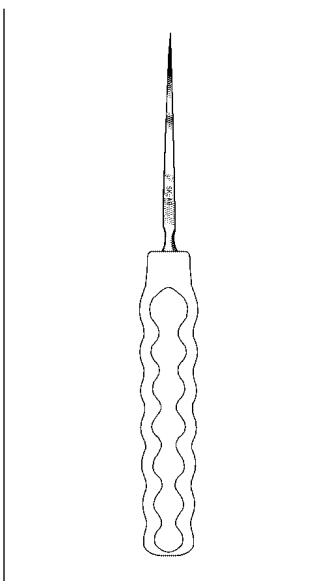
KIRSCHNER BOW

40-1750 5¼" Medium
Maximum Jaw Opening 5"
40-1752 7½" Large
Maximum Jaw Opening 8½"
40-1754 9½" Extra Long
Maximum Jaw Opening 8¼"



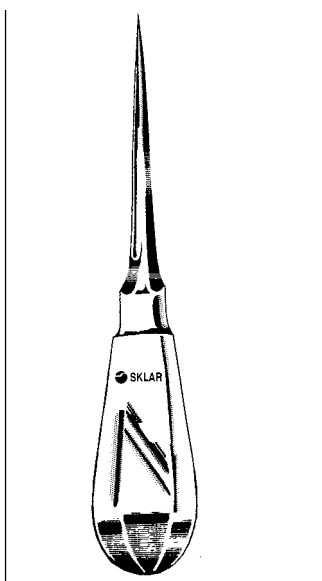
STEINMANN PIN CHUCK

40-1645 4½" Chrome



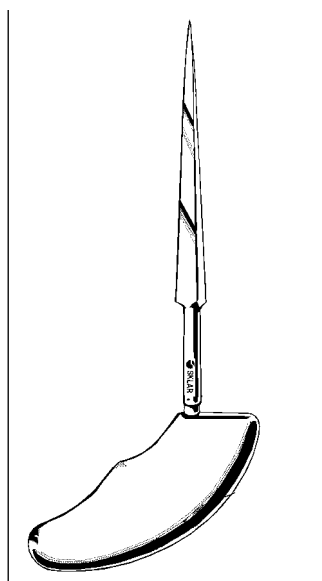
BONE AWL

40-1640 6½" (16.5 cm) Straight
Four sided, autoclavable
handle



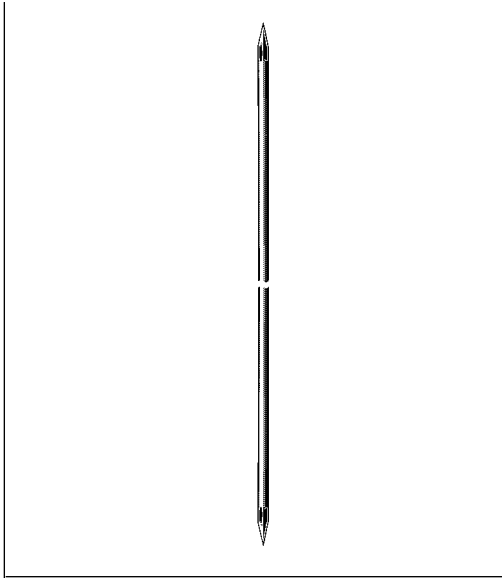
BONE AWL

40-1642 5½" Square taper



PERTHES BONE AWL

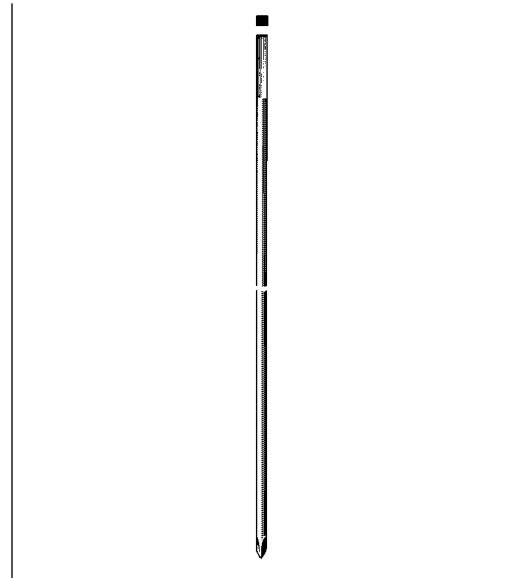
40-1644 8¼"



KIRSCHNER WIRES

Two Trocar Ends

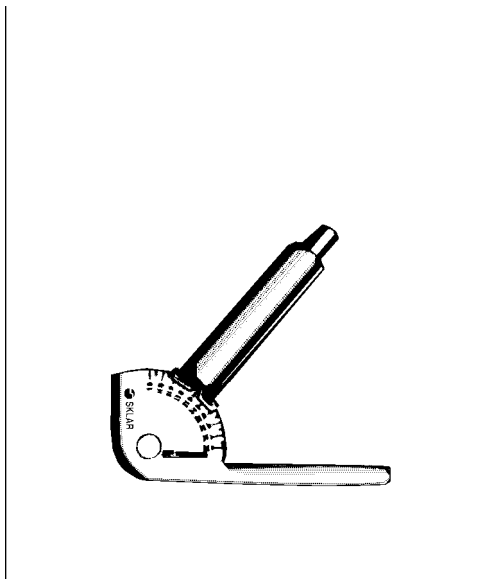
40-1535	12" x .035	40-1567	4" x .045
40-1545	12" x .045	40-1568	4" x .054
40-1562	12" x .062	40-1569	4" x .062
40-1565	4" x .028	40-1580	9" x .035
40-1566	4" x .035	40-1582	9" x .045
		40-1584	9" x .062



STEINMANN PINS

Trocar Point

40-1590	9" x 2 mm	40-1594	9" x 3.5 mm
40-1591	9" x 2.4 mm	40-1595	9" x 4.0 mm
40-1592	9" x 2.8 mm	40-1596	9" x 4.5 mm
40-1593	9" x 3.2 mm		

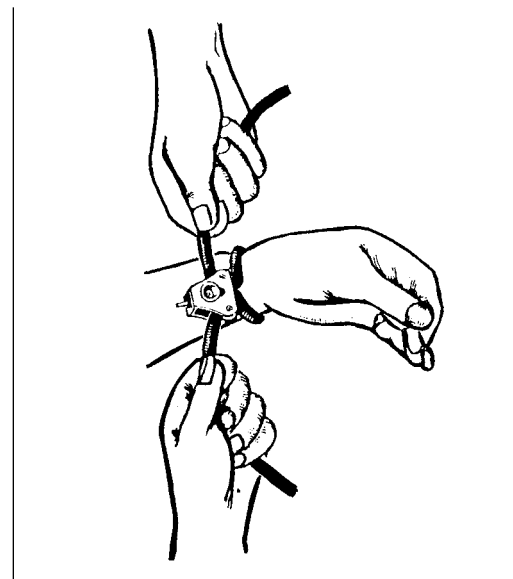


ADJUSTABLE ANGLE GUIDE

Stainless Steel

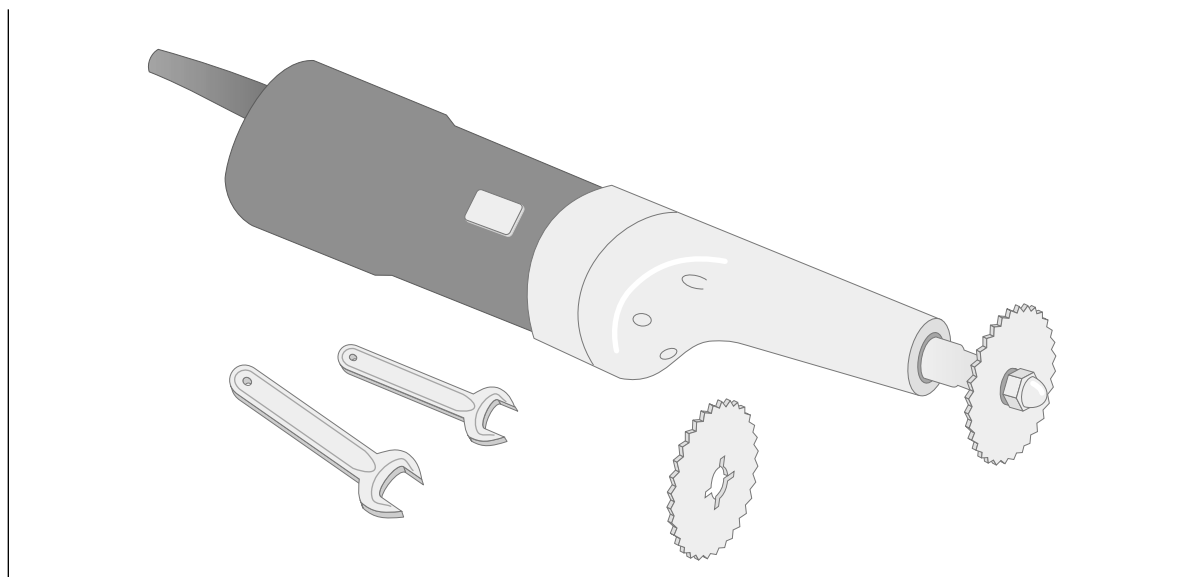
40-9990	3" (76.2 mm) long
---------	-------------------

Used for placing guide wire at proper angle for the plate selected.



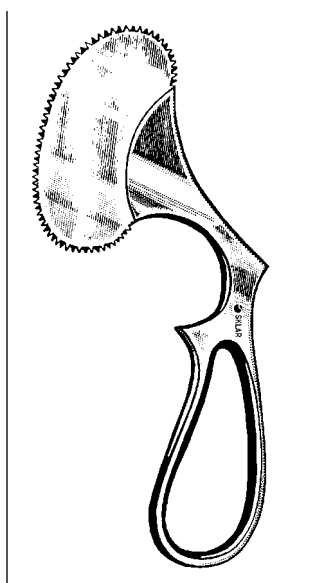
N-I AUTOMATIC TOURNIQUET

Black Tubing		White Tubing	
40-1915	Complete	40-1918	Complete
40-1916	Black Tubing Only	40-1919	White Tubing Only



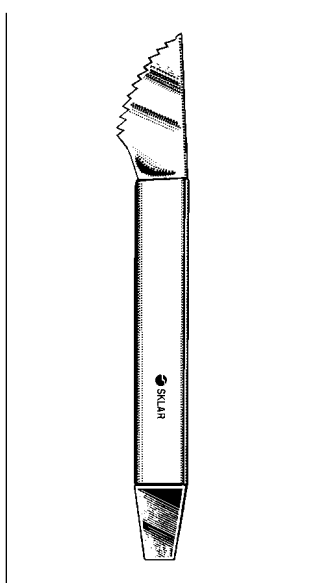
OSCILLATING PLASTER SAW

- 11-2100 110V Complete
- 11-2101 220V Complete
- 11-2105 Blade Only 50 mm
- 11-2110 Blade Only 56 mm
- 11-2115 Wrenches only



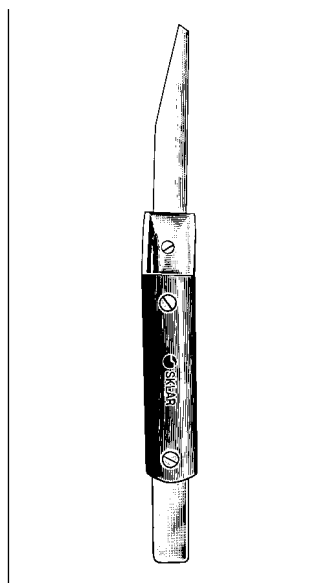
ENGEL PLASTER SAW

11-1525 Chrome Plated



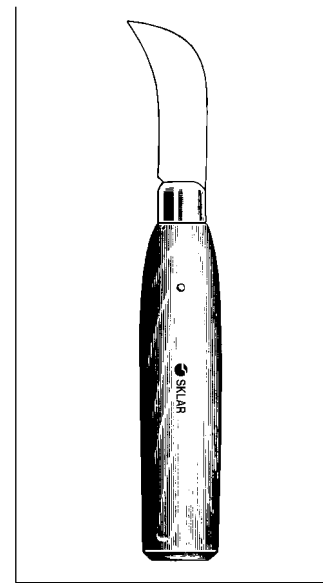
WIGMORE PLASTER SAW

11-1530 With Lift



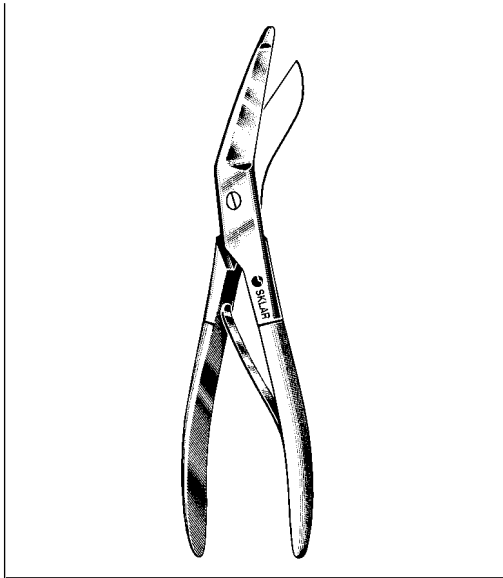
RIDLON PLASTER KNIFE

Detachable Blade
 11-1545 Complete, 2 Each
 11-1546 Blade Only
 11-1547 Handle Only



MURPHY PLASTER KNIFE

Wood Handle
 11-1540



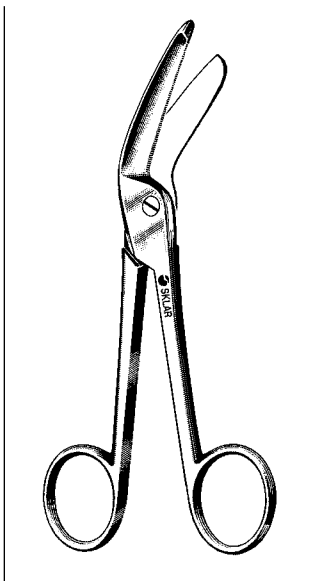
SEUTIN PLASTER SHEARS

Heavy Plier Handle
11-1490 9" Serrated



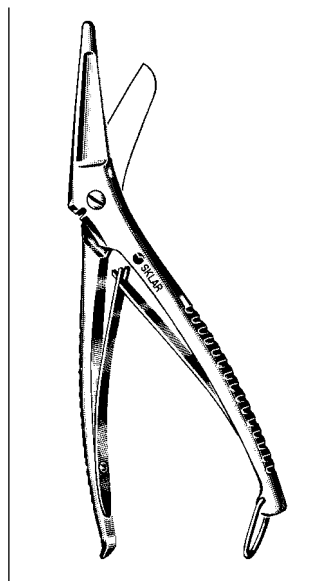
BRUNS SHEARS

Serrated
11-1295 9 1/4"
16-2820 9 1/4" T-C



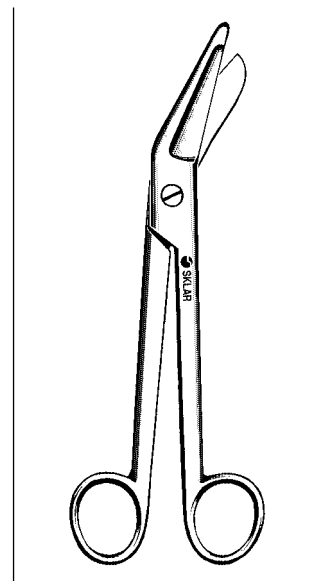
HERCULES UTILITY SCISSORS

11-1297 7 1/2" Serrated



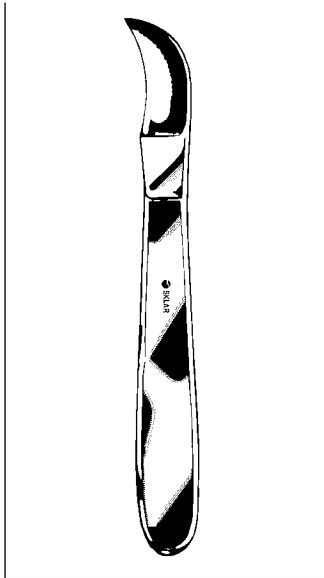
COMMANDER UTILITY SHEARS

Heavy Duty with Wire Cutting Notch
11-1298 8 1/2"



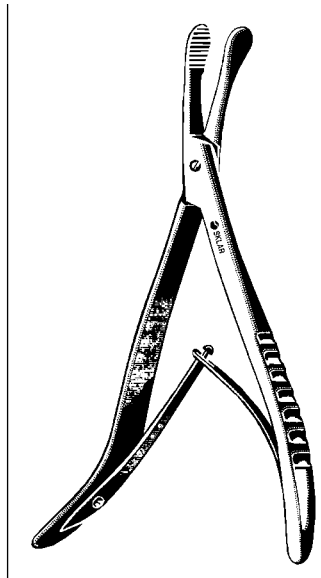
ESMARCH SHEARS

Heavy Pattern
11-1380 8"
11-1390 9"



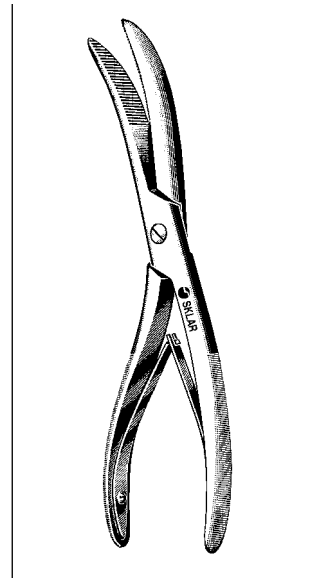
REINER PLASTER KNIFE

Metal Handle
11-1550 7" 1½" Blade



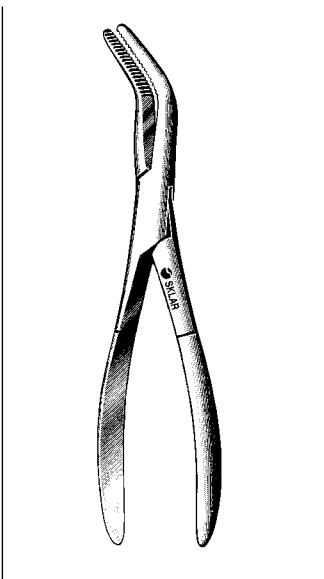
PEDIATRIC CAST BREAKER

11-2098 7" (18 cm) Mason



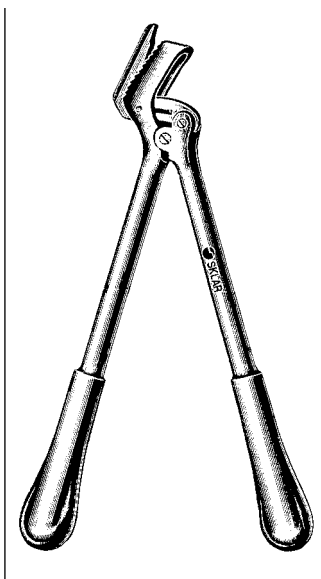
WOLFE-BOEHLER

Plaster Cast Breaker
11-2095 10"



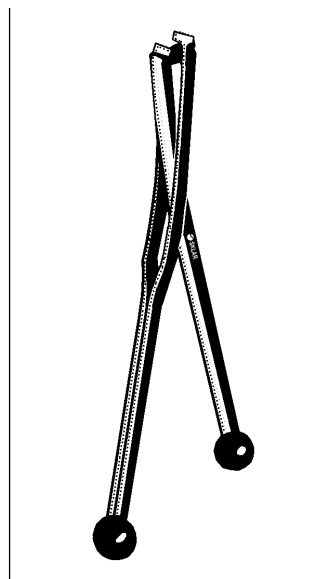
VAN BUREN PLASTER FORCEPS

Delicate
40-2085 8½" Curved
40-2185 8½" Angular



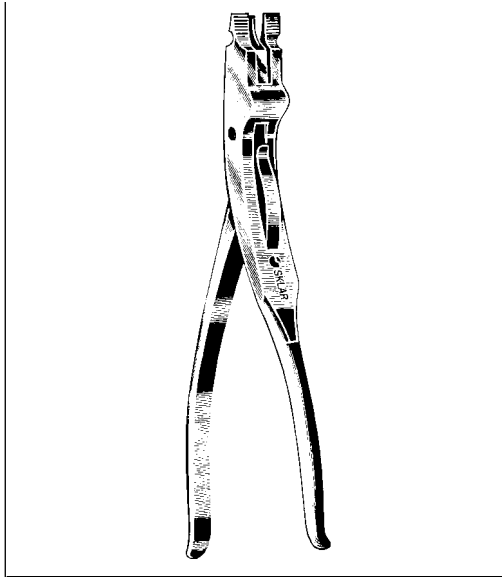
STILLE PLASTER SHEARS

11-1610 10"
11-1615 15"



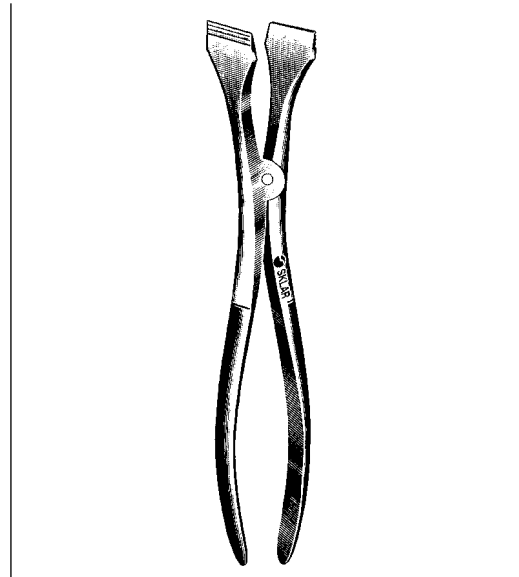
HEAVY DUTY CAST SPREADER

Martin Pattern
11-1995 4" Opening
18½" Long



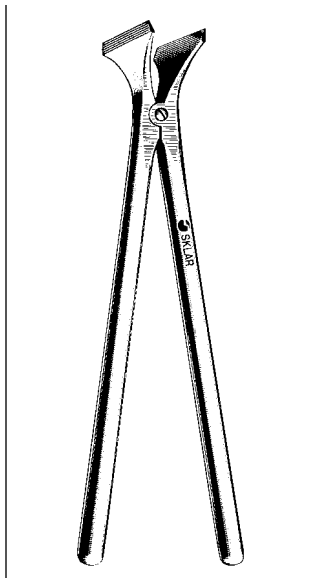
WALTON PLASTER SPREADER

3 Blade
11-1990 9"



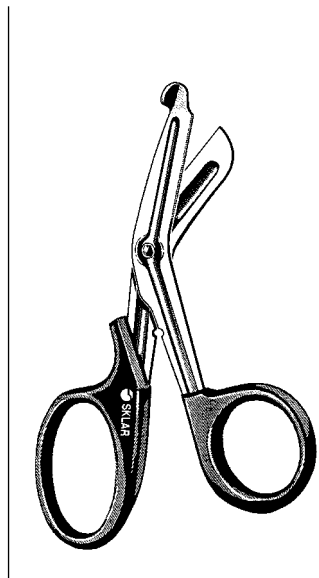
HENNIG PLASTER SPREADER

2 Blade
11-1910 11"



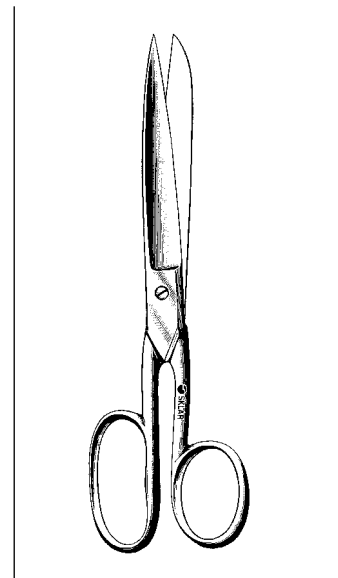
BEESON PLASTER SPREADER

2 Blade
11-1812 12"



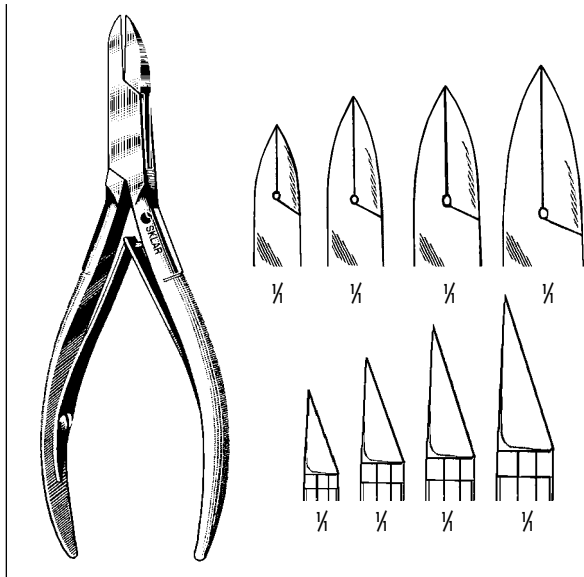
MULTI-CUT UTILITY SCISSORS

Serrated
11-1278 6"
11-1280 7½"



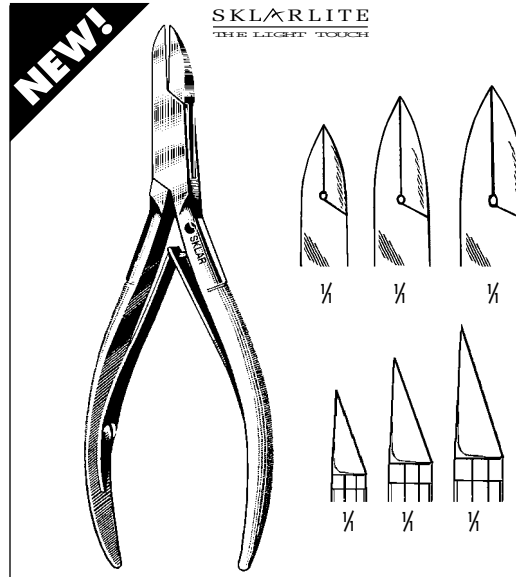
USA PATTERN GAUZE SCISSORS

11-1180 8" Stainless



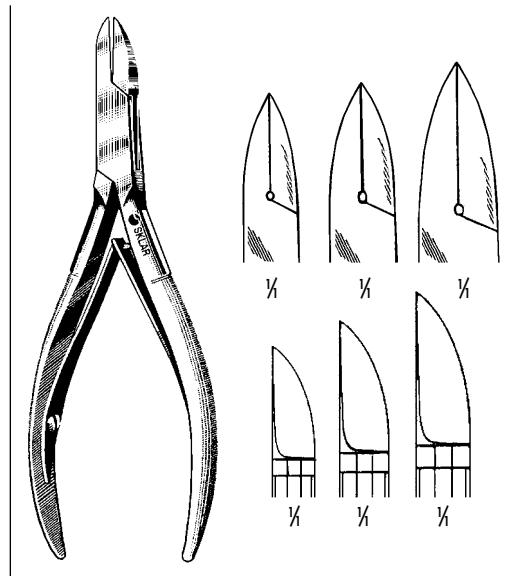
LITTAUER CUTTING FORCEPS

Straight Back—Stainless	Straight Back—Chrome
97-1251 4"	97-1250 4"
97-1255 4½"	
97-1259 5"	97-1258 5"
97-1262 6"	97-1261 6"



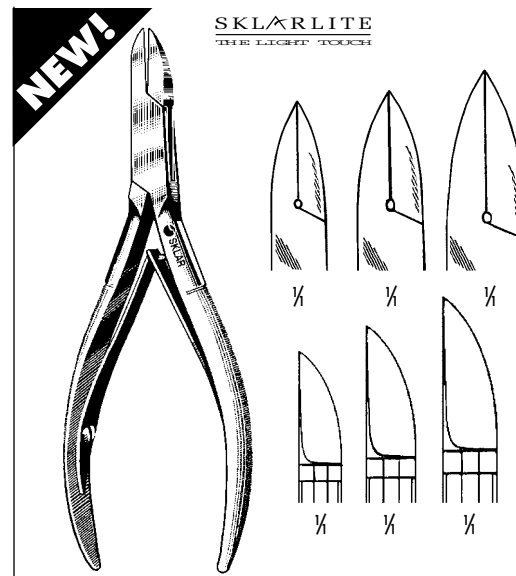
SKLARLITE LITTAUER CUTTING FORCEPS

Straight Back—Stainless
23-9251 4"
23-9255 4½"
23-9259 5"



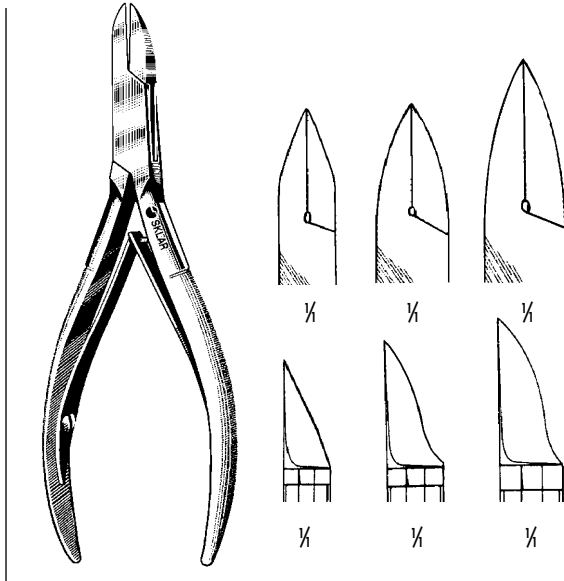
LITTAUER CUTTING FORCEPS

Curved Back—Stainless
97-1280 4½"
97-1285 5"
97-1286 6"



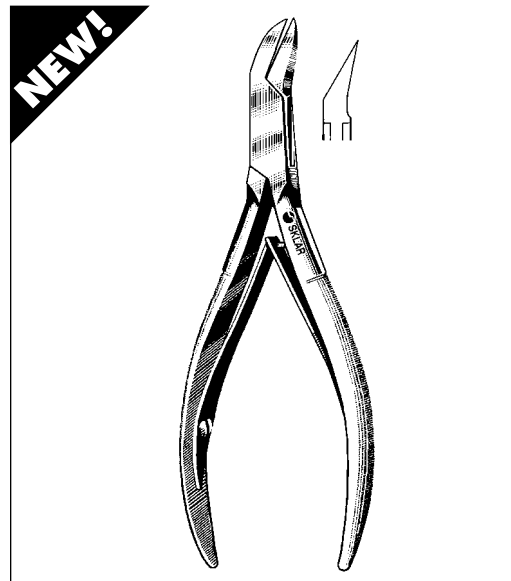
SKLARLITE LITTAUER CUTTING FORCEPS

Curved Back—Stainless
23-9273 4½"
23-9275 5"
23-9276 6"



SKLAR-TAPER™ LITTAUER CUTTING FORCEPS

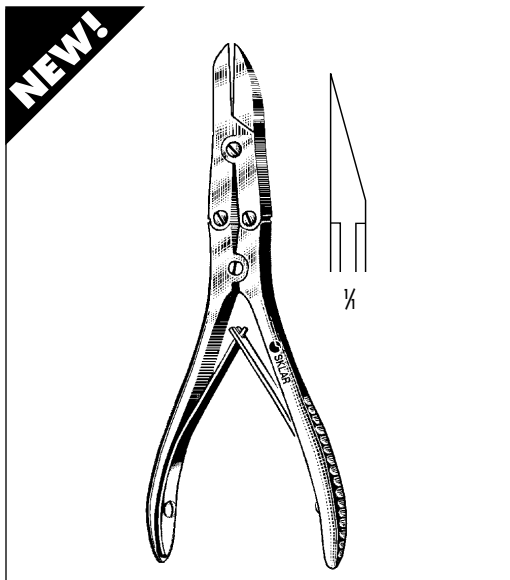
Stainless
 97-1172 4½"
 97-1174 5"
 97-1176 6"



SKLAR-ANGULAR™ LITTAUER CUTTING FORCEPS

Angular Jaw—Straight Back Stainless
 97-1180 4"
 97-1181 4½"
 97-1182 5"
 97-1183 6"

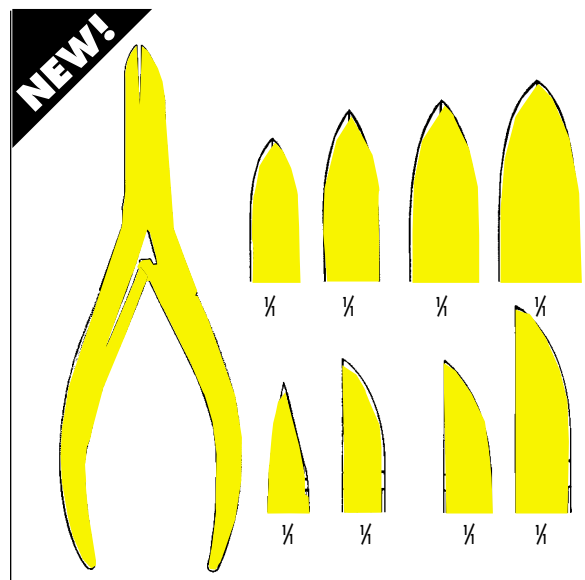
Exclusive Sklar design, angles the cutting head to provide optimum cutting angle between doctor and patient.



SKLAR DOUBLE-ACTION LITTAUER CUTTING FORCEPS

97-1185 6" Straight

Exclusive Sklar design, offers increased mechanical advantage with the most popular Littauer cutting jaw.

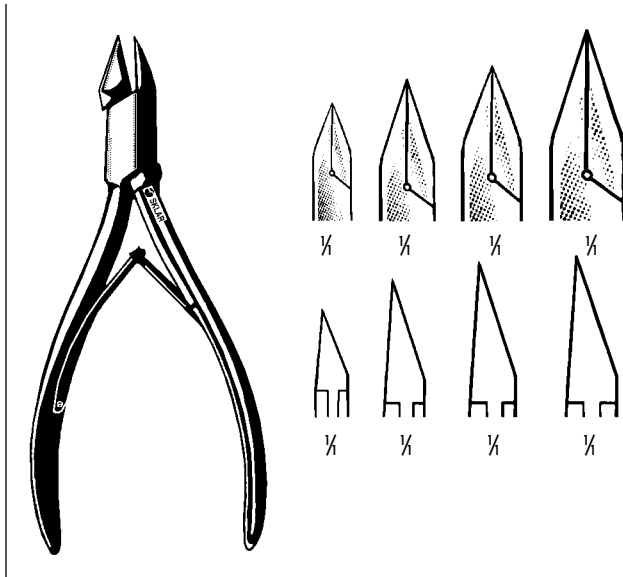


SKLAR TITANIUM-NITRIDE LITTAUER CUTTING FORCEPS

Straight Back	Curved Back
25-9751 4"	25-9780 4½"
25-9755 4½"	25-9785 5"
25-9759 5"	25-9786 6"
25-9762 6"	

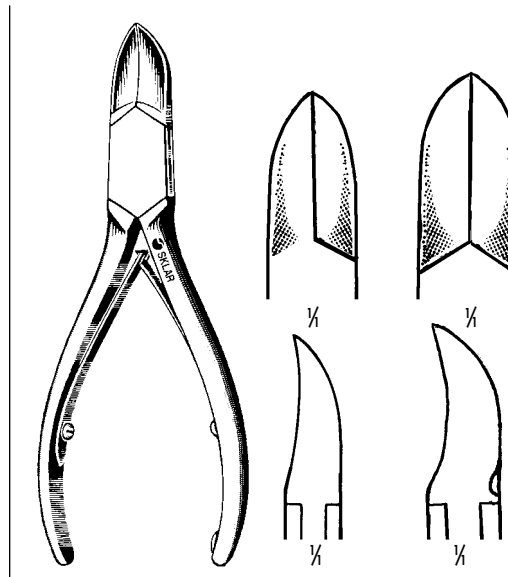
Sklar Exclusive

- Longer Life
- Corrosion Resistance
- Harder Cutting Edges (R84)



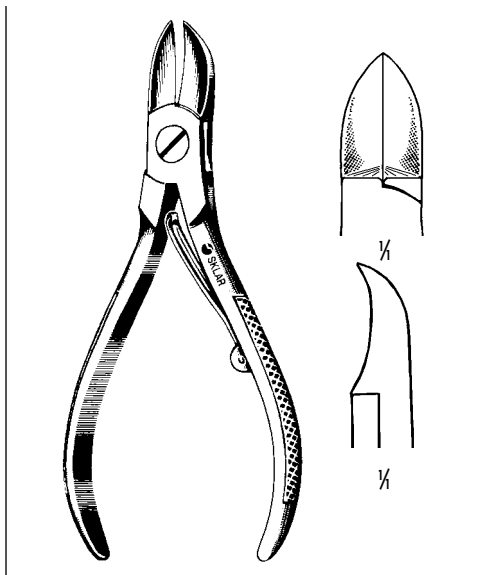
SKLAR NAIL SPLITTER

Tapered Jaw
Straight Back—Stainless
97-1660 4"
97-1661 4½"
97-1662 5"
97-1663 6"



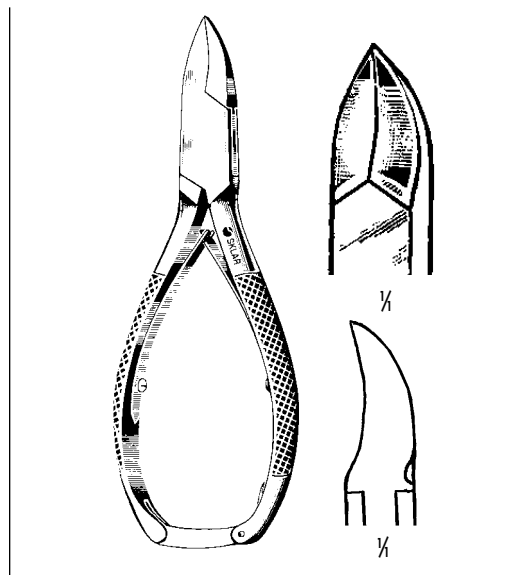
NAIL NIPPER

Concave Blades
97-1308 6" Stainless Narrow
97-1309 5½" Stainless Heavy



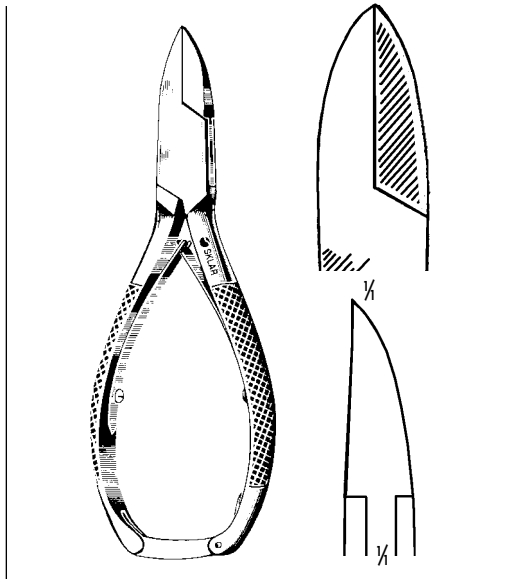
NAIL NIPPER

Concave Blades—Folding Spring
97-1145 4½" Chrome
97-1146 4½" Stainless



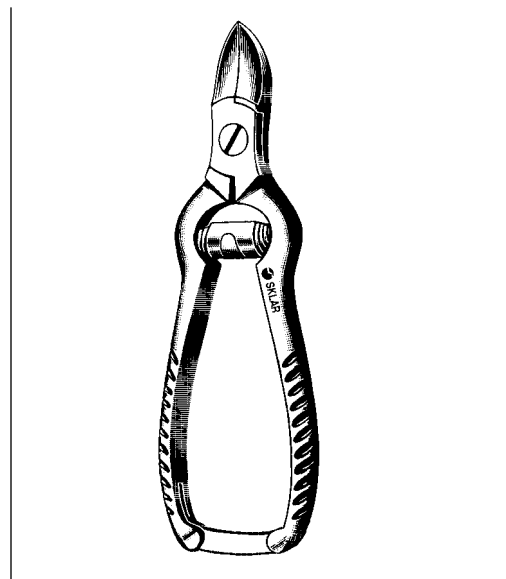
NAIL NIPPER

Concave Blades
97-0474 5½" Stainless
97-1055 5½" Chrome



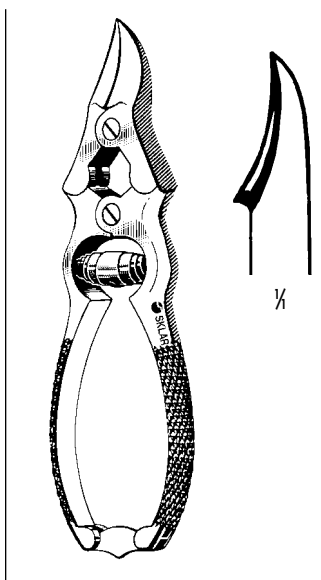
NAIL NIPPER

97-1056 5 1/2" Straight Back



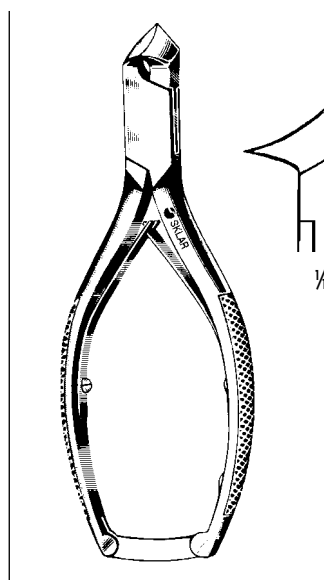
NAIL NIPPER

Concave Blades-Barrel Spring
97-1045 4 1/2"
97-1046 5 1/2"



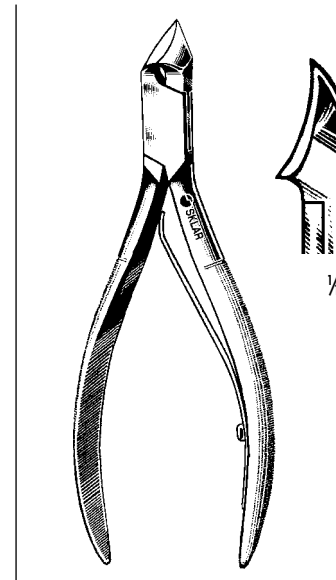
NAIL NIPPER

Double Action
97-1057 5 3/4" Stainless



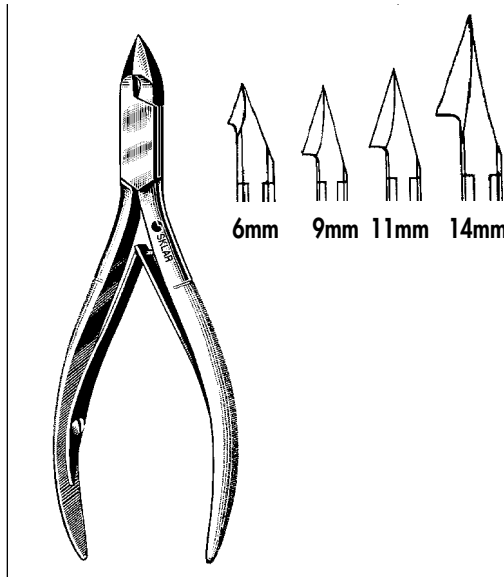
NAIL NIPPER

Angled Concave Blades
97-1155 5 1/2" Chrome
97-1156 5 1/2" Stainless



NAIL NIPPER

Slight Angled Blades
97-1161 5 1/2" Stainless



TISSUE NIPPER

Convex Blades

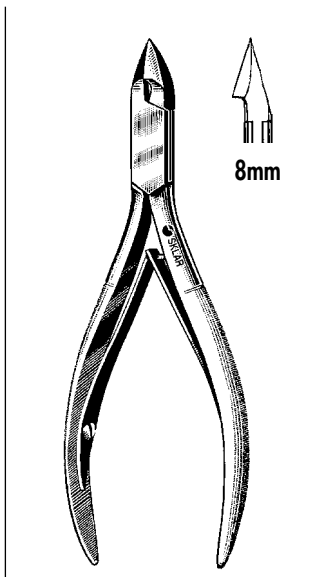
97-1241	4"	Stainless	6mm
97-0302	4"	Chrome	6mm
97-0335	4"	Stainless	9mm
97-1300	4"	Chrome	9mm
97-1242	4½"	Stainless	11mm
97-1243	5"	Stainless	14mm



SKLARLITE TISSUE NIPPER

Convex Blades—Stainless

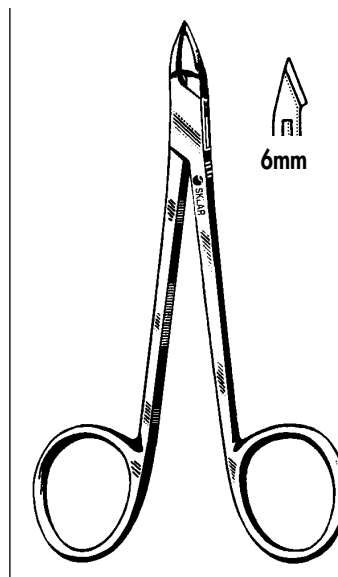
23-9292	4½"	Double Spring	11mm
---------	-----	---------------	------



CUTICLE NIPPER

Convex Blades

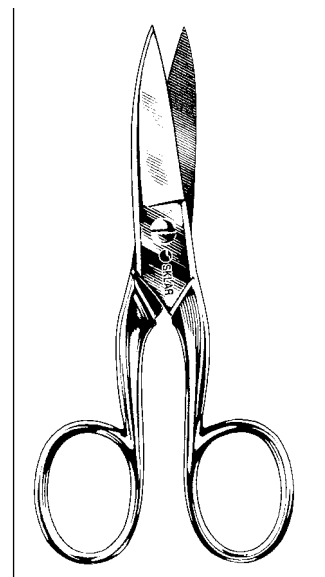
97-1244	5"	Stainless	8mm
---------	----	-----------	-----



TISSUE FORCEPS

Scissors Handle—Straight Jaws

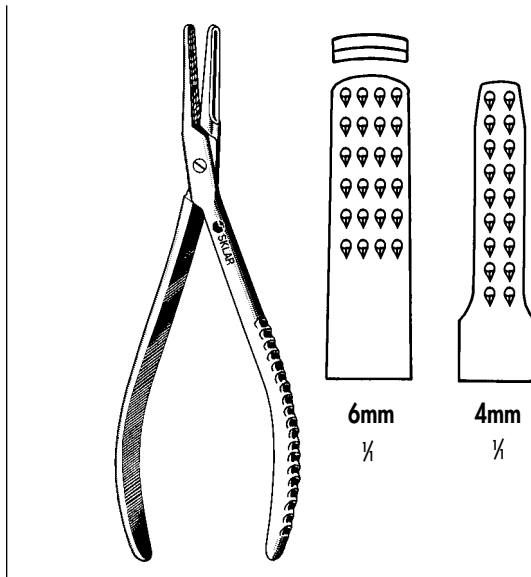
97-1238	Stainless	4"
---------	-----------	----



CUTICLE AND NAIL NIPPER

Ring Handle

97-1235	3½"	Finger Nail
97-1245	4½"	Toe Nail

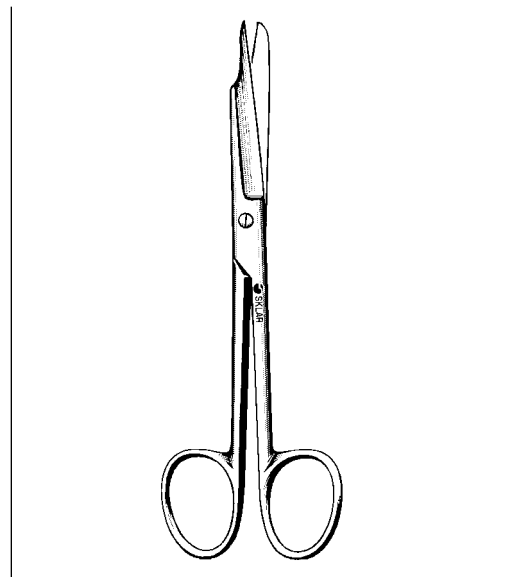


PLATYPUS NAIL FORCEPS

Plier Handle

97-1318 5 1/4" 6mm wide

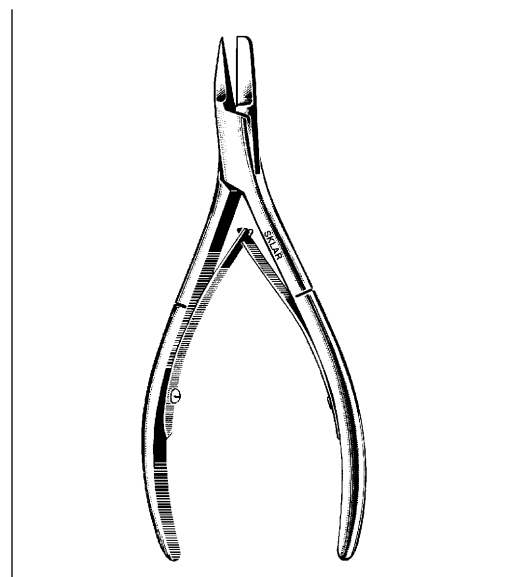
97-1315 5 1/4" 4mm wide



INGROWN NAIL SPLITTING SCISSORS

One Pointed Blade

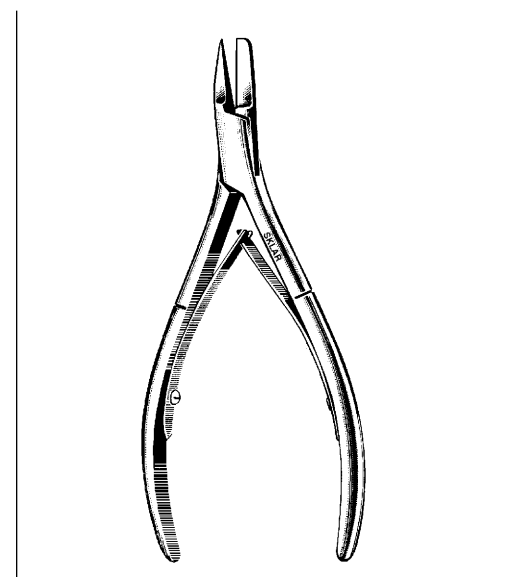
97-0555 6" One Blade Serrated



INGROWN TOE NAIL FORCEPS

English (Anvil) Pattern

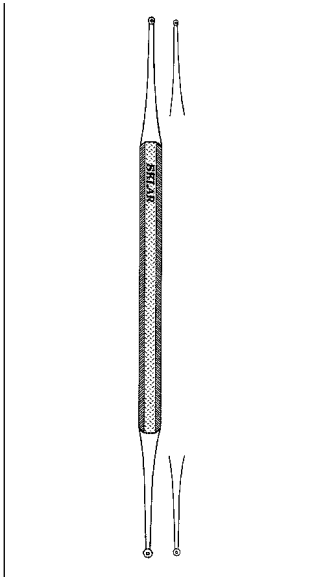
97-1150 5" Stainless



SKLARLITE INGROWN TOE NAIL FORCEPS

English (Anvil) Pattern

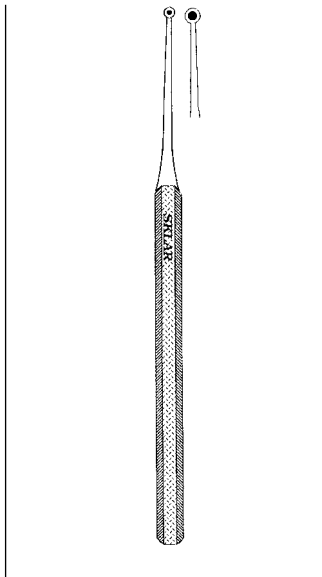
23-9250 5" Stainless



CURETTE-EXCAVATOR

Double End with Hole 5 1/2"

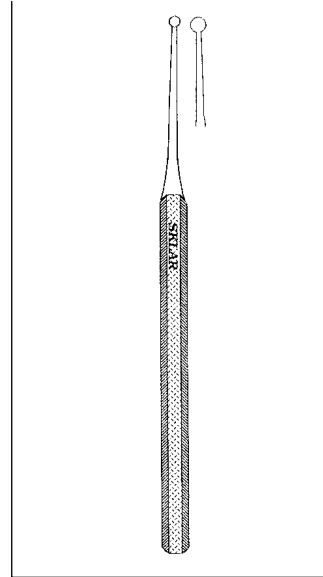
97-0532 #58-1-2 1.5-2.0 mm
97-0536 #58-1-3 1.5-2.5 mm



CURETTE-EXCAVATOR

Single End with Hole 5"

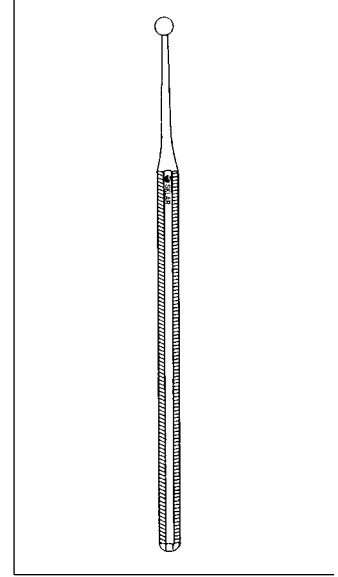
97-0512 #58-0 1.0 mm
97-0522 #58-1 1.5 mm
97-0524 #58-2 2.0 mm
97-0528 #58-3 2.5 mm



CURETTE-EXCAVATOR

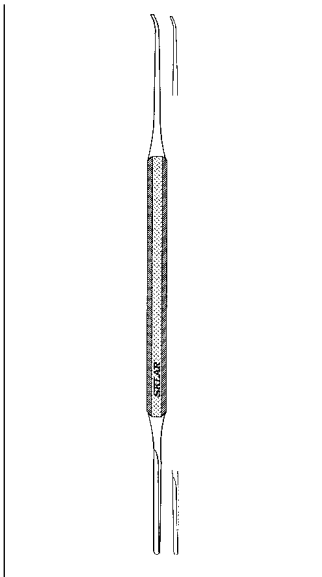
Single End without Hole 5"

97-0503 #57-0 1.0 mm
97-0505 #57-1 1.5 mm
97-0507 #57-2 2.0 mm
97-0509 #57-3 2.5 mm



VERUCCA CURETTE

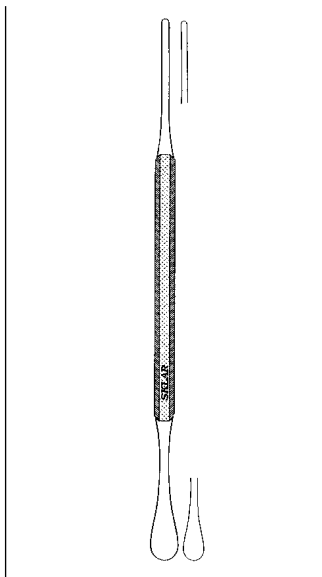
97-0564 4 mm



PROBE AND PACKER

Double End 6"

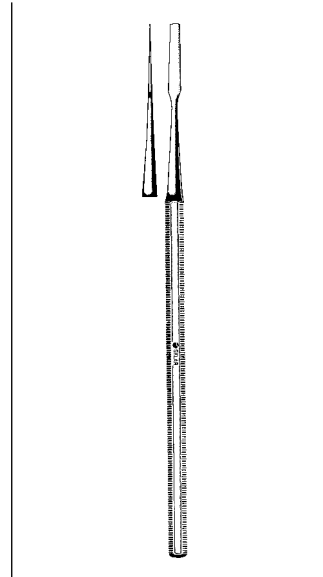
97-0539 #92 Blunt



SPATULA AND PACKER

Double End 5 3/4"

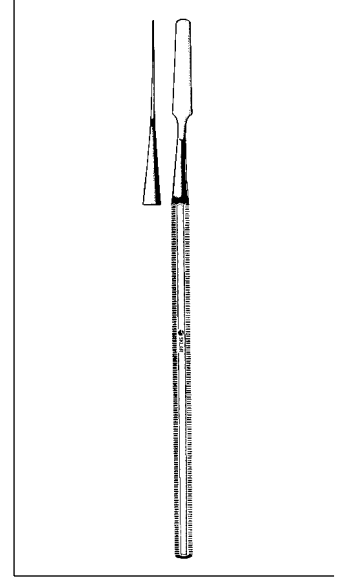
97-0542 #91



SPATULA

Square End

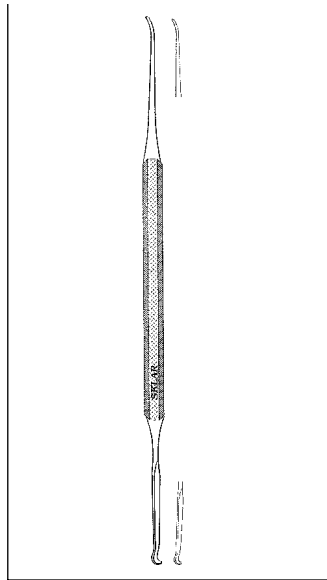
97-0580 6 mm



SPATULA

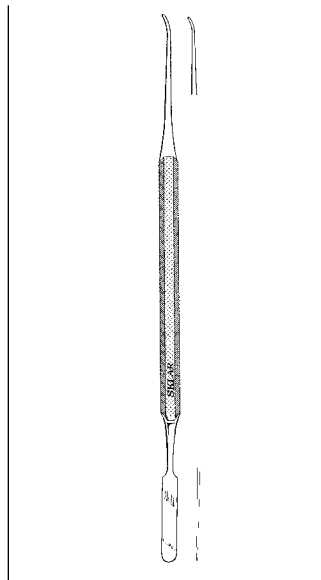
Rounded End

97-0581 4 mm



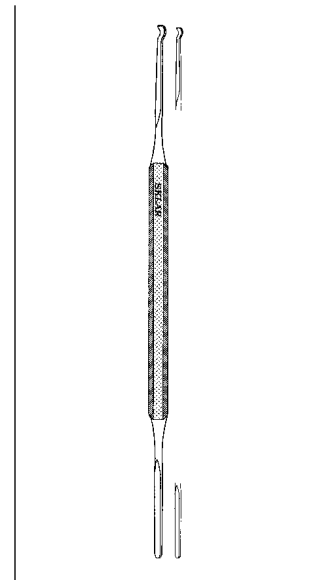
EXCAVATOR & PACKER

Double End
97-0562 6" #89



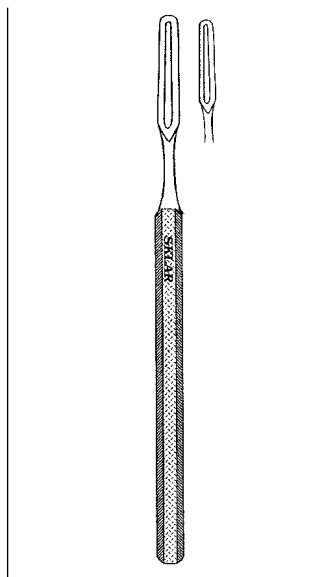
PROBE & SPATULA

Double End
97-0548 6"



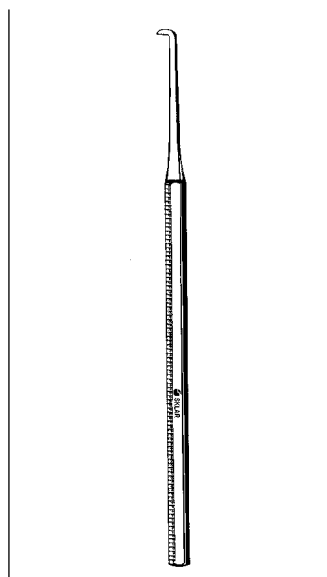
EXCAVATOR & PACKER

Double End 5 3/4"
97-0546 #90



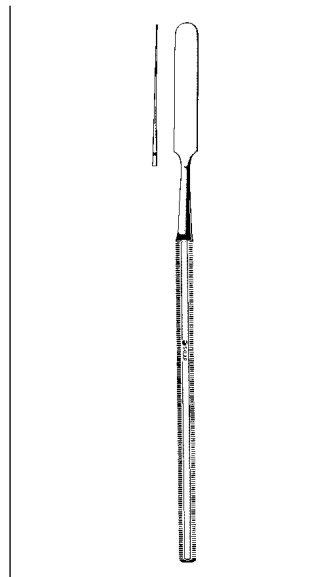
**INGROWN NAIL
INSTRUMENT**

Fenestrated
97-0554



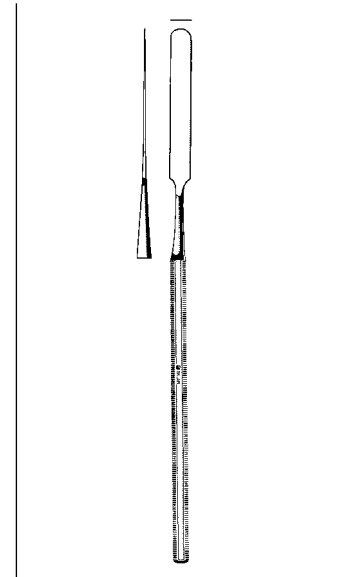
**BAKER INGROWN NAIL
CUTTER**

97-0552



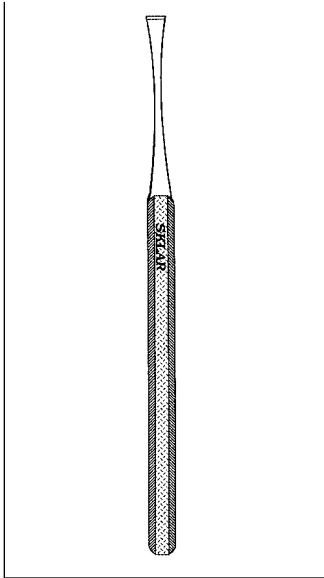
SPATULA

Rounded End
97-0582 6 mm #24A



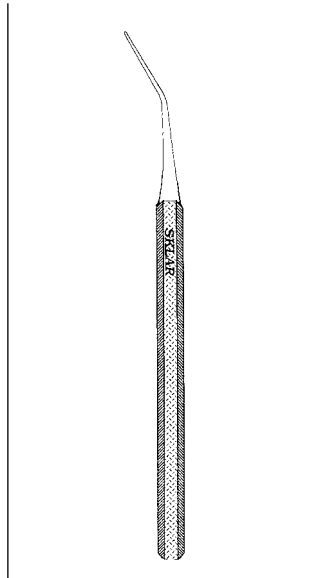
SPATULA

Rounded End
97-0583 7 mm #24



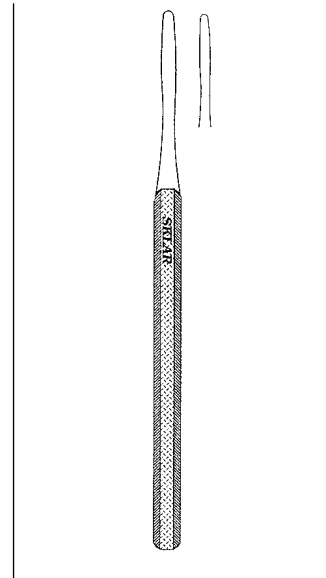
NAILSPLITTER

97-0601 Straight-Narrow 2mm #59
97-0604 Straight-Wide 3.5mm #61



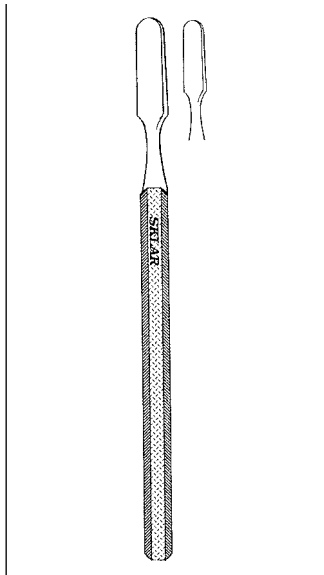
NAIL SPLITTER

97-0606 Angular-Narrow 2mm #60



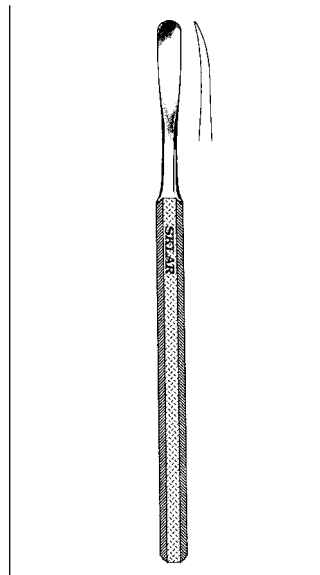
NUCLEUS KNIFE

Single End
97-0568 Narrow 2mm
97-0572 Wide 3mm
97-0566 Short Handle



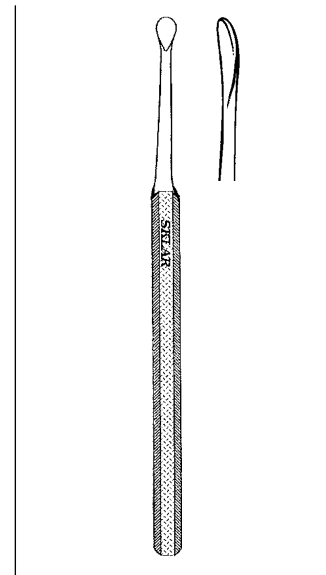
LOCKE ELEVATOR

97-0623 Narrow 3 x 15mm #94
97-0634 Wide 5 x 20mm #96



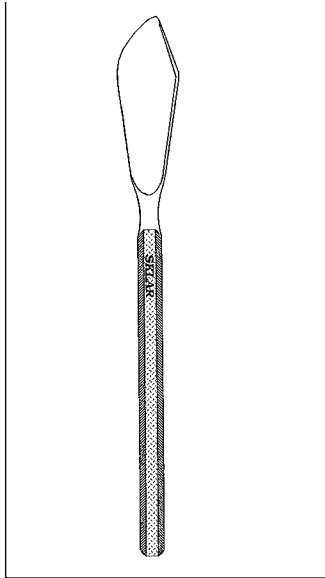
ELEVATOR CURVED EDGE

Semi-Sharp
97-0048 5/8"



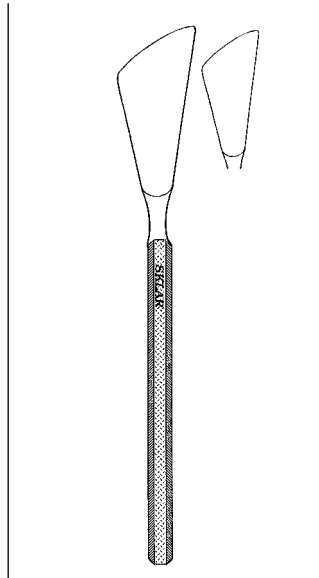
SOFT CORN KNIFE

Round Blade
97-0035 Straight
97-0036 Curved Blade



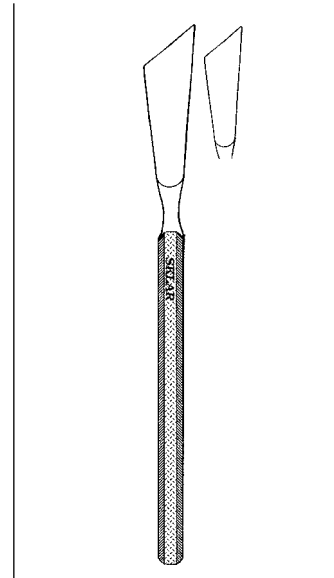
**CORN KNIFE EXTRA
HEAVY**

Curved Edge
 97-0019 Large
 97-0020 Medium
 97-0021 Small



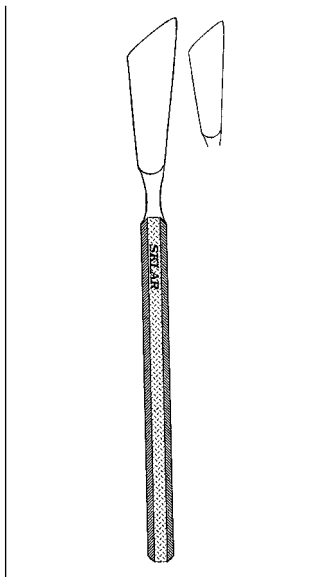
KNIFE

Straight Back
 97-0015 Small 15mm
 97-0017 Large 18mm



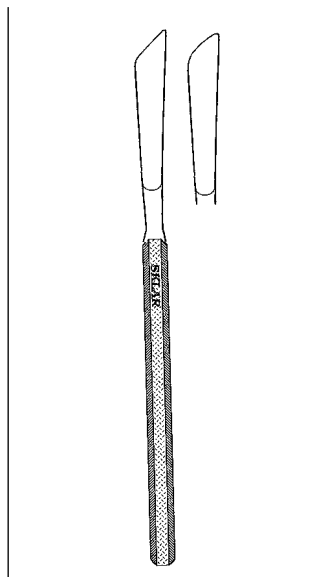
CHISEL KNIFE

Straight Edge
 97-0010 Small 8mm
 97-0011 Medium 15mm



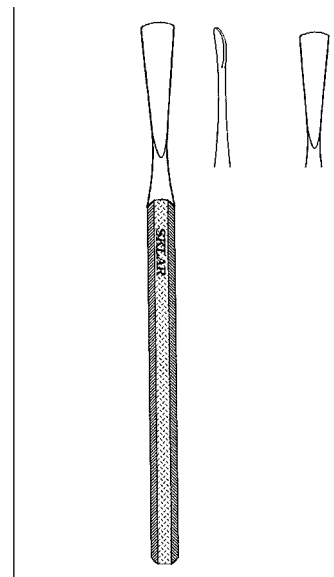
CHISEL KNIFE

Curved Edge
 97-0005 Small 13mm
 97-0006 Medium 18mm



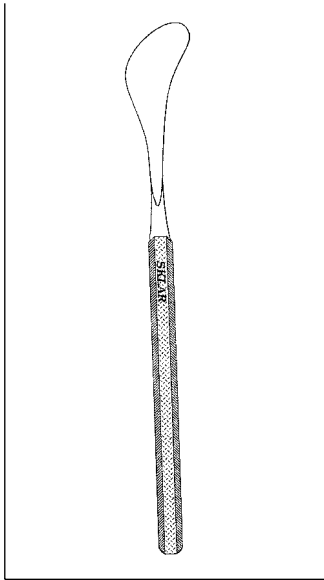
CORN CHISEL

Angled Edge
 97-0040 Sharp Point
 Curved Edge
 97-0041 Round Point



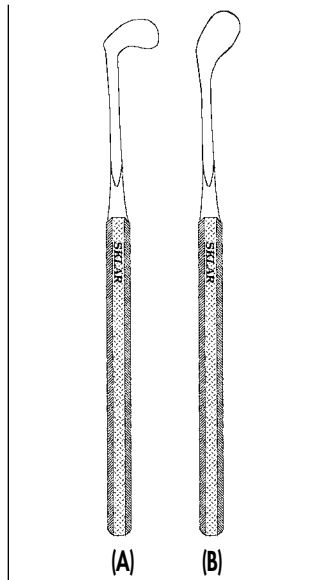
CORN CHISEL

Curved Edge
 97-0540 Spade Shape 5/4"
 97-0545 Spoon Shape 5/4"



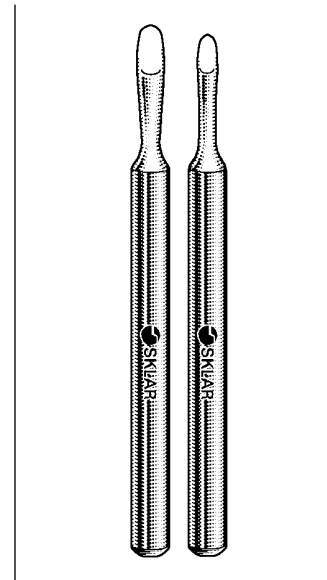
GOLF STICK KNIFE

97-0025 Small
97-0026 Medium
97-0027 Large



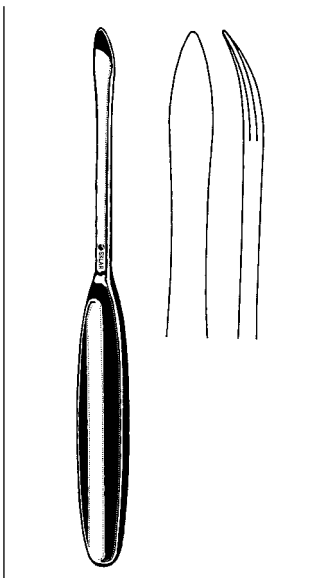
GOLF STICK KNIFE

97-0028 Style A
97-0030 Style B



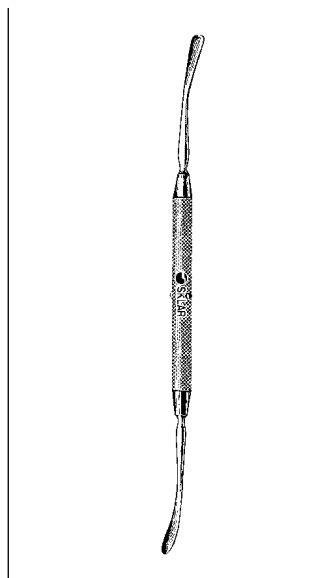
FROST ELEVATOR

97-0640 Narrow
97-0641 Wide



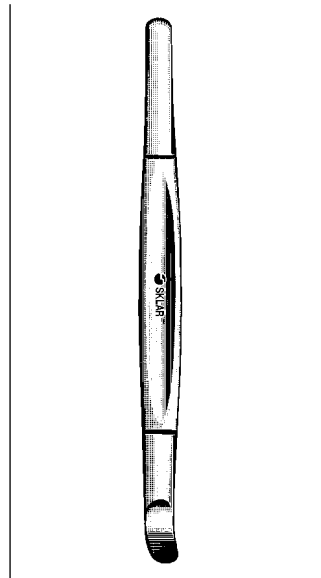
LANGENBECK ELEVATOR

40-8375 7½" (Lane Narrow)



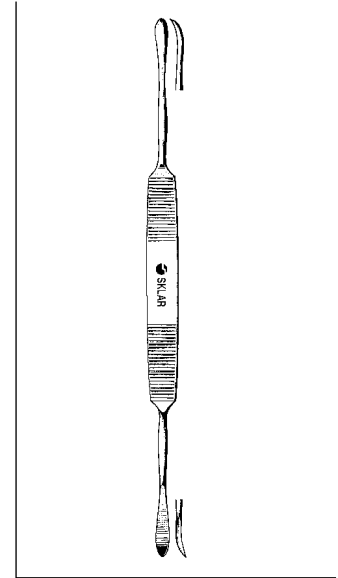
FREER ELEVATOR

Double Ended
47-2380 8" S/B



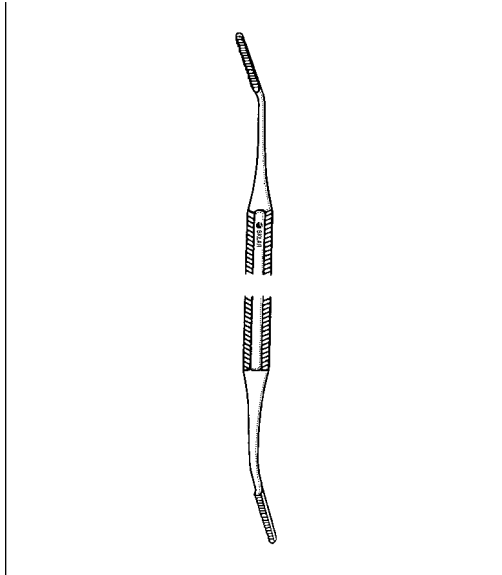
SAYRE ELEVATOR

Double Ended
40-9265 6½" Curved End Sharp
Straight End Blunt
40-9365 6½" Both Ends Blunt



OHL ELEVATOR

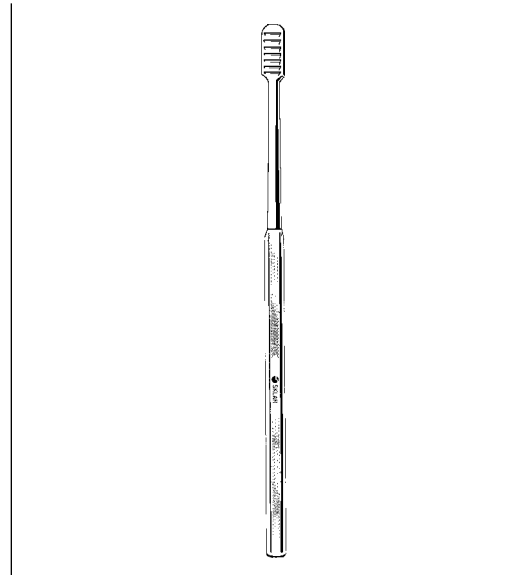
97-0050 11" S-Curve



NAIL AND BONE RASP

Double End

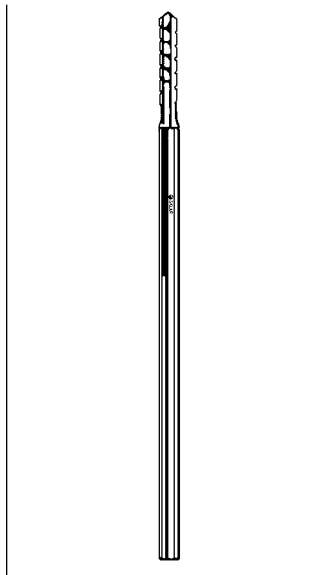
97-1610 Inside/Outside #92
 97-1600 Single End/Inside Cut #92A
 97-1605 Single End/Outside Cut #92B



PODI-BONE RASP

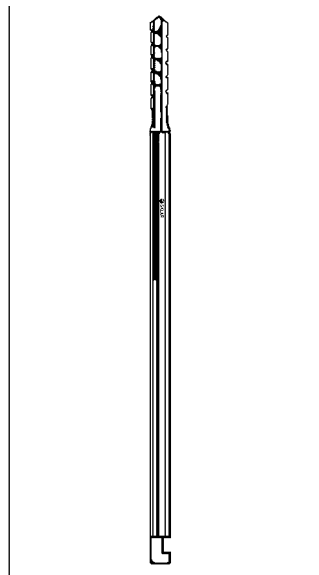
Single End

97-1649 4 1/4" Long
 3/8" Long Rasp Tip



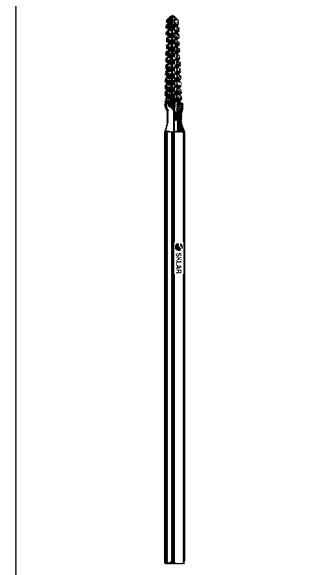
STANDARD BUR

97-1572 #44 Stainless
 97-1573 #44 Titanium Nitride Coating



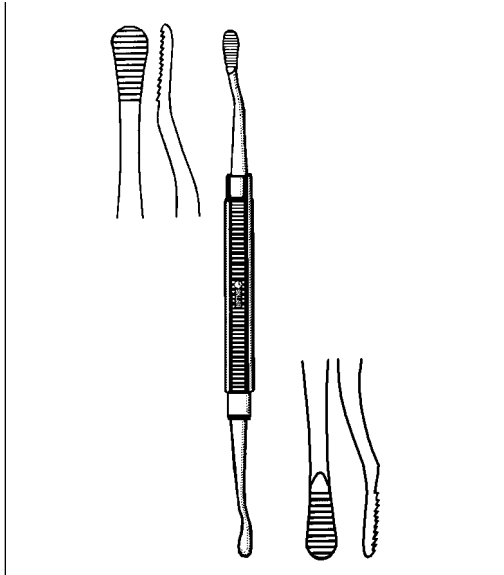
BUR WITH NOTCH

97-1574 #44 Stainless with Stryker
 Notch



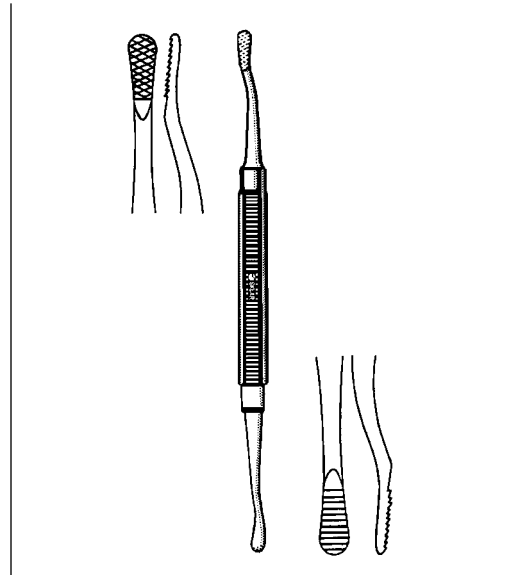
BUR/43

97-1575 #43 Stainless



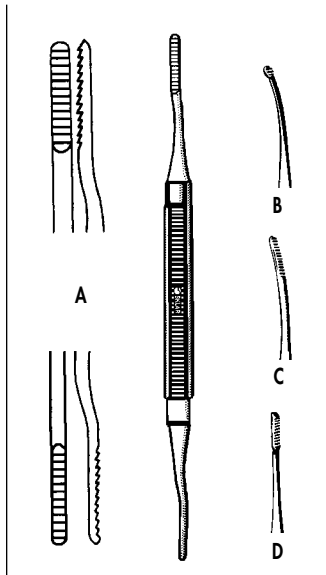
BONE FILE #12

Double End
97-1620 7" Plain Serrations
Both Ends



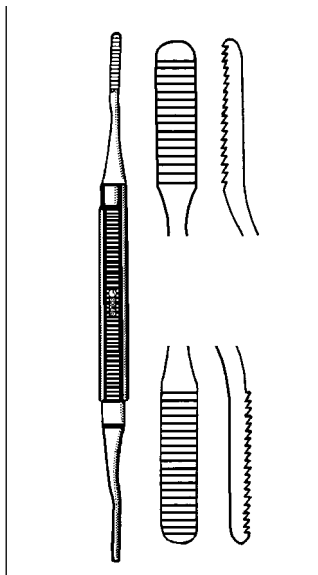
BONE FILE #12A

Double End
97-1625 7" Plain Serrations
& Cross Serrations



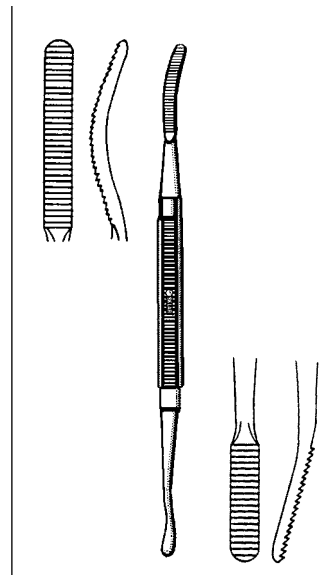
NAIL AND BONE RASP

- 97-1640 7" Plain Serrations (A)
Double End, 3mm & 4mm
- 97-1641 6" Polokoff Fine Serrations (B)
Single End
- 97-1642 6½" Polokoff Medium Serrations (C)
Single End
- 97-1643 6¼" Polokoff Chisel End (D)
1.3mm Straight



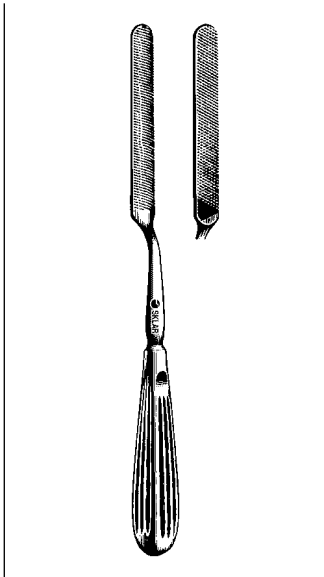
NAIL AND BONE RASP

Double End
97-1645 8½" Plain Serrations



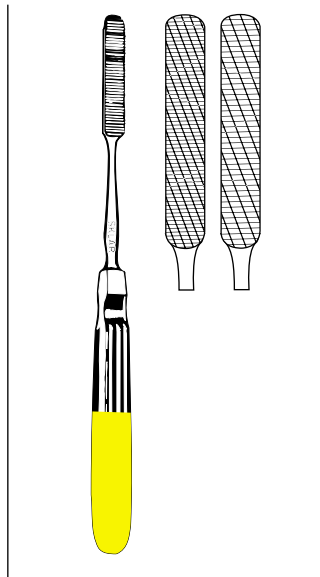
BONE RASP #10

Double End-Curved & Flat Ends
97-1615 7"



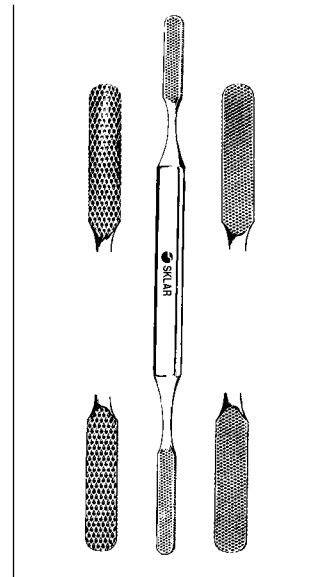
BONE FILE

Bayonet Handle
40-9685 8½"



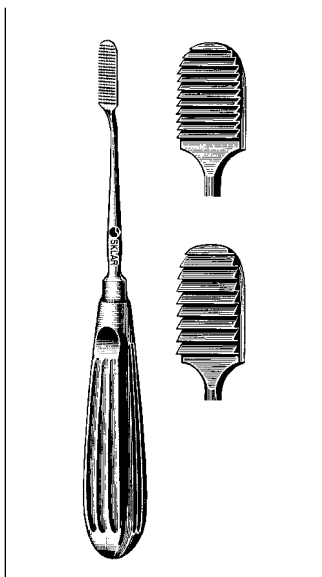
T-C MALTZ RASP

Single End
97-1505 Fine
97-1506 Medium



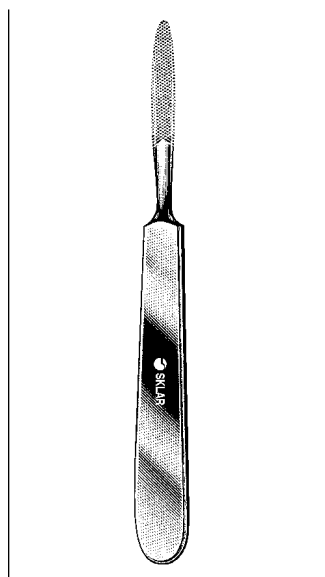
FOMON RASP AND FILE

Double End-4 Sided
40-9688 8½"



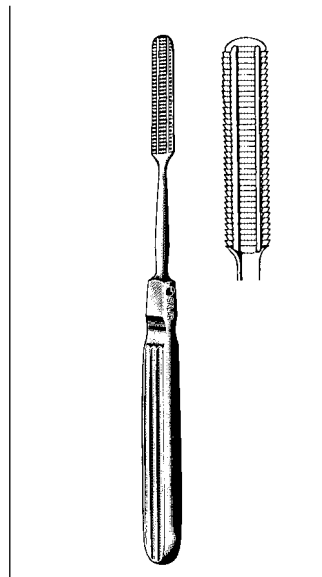
LEWIS RASP

70-2292 7" Fine
70-2293 7" Coarse



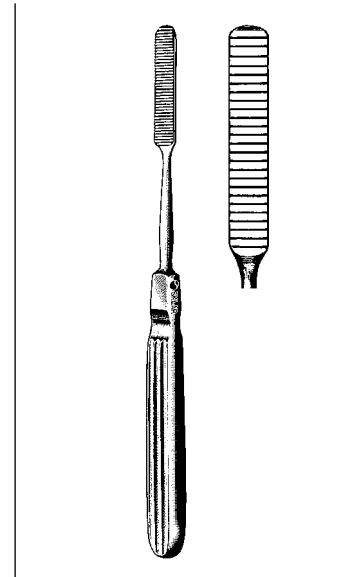
JOSEPH RASP

Straight Handle
40-9825 6¼"



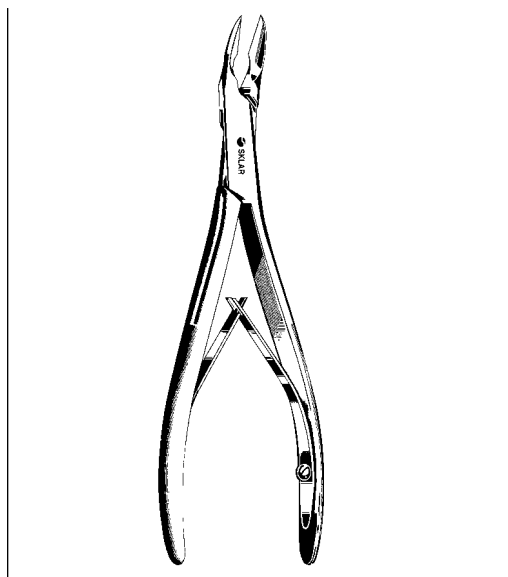
MALTZ RASP

40-9815 7"



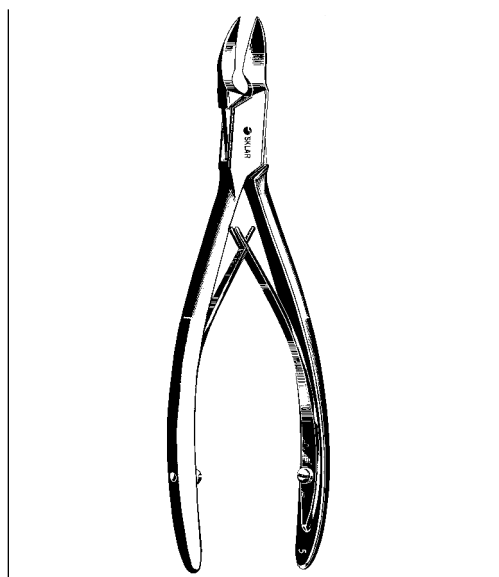
COTTLE RASP

40-9820 8½"



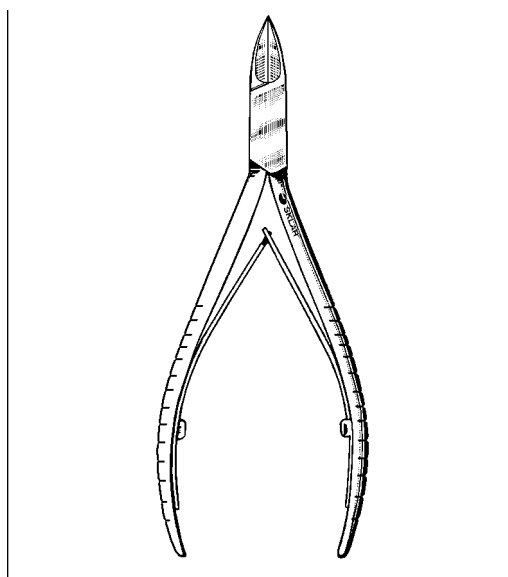
RONGEUR NO. 5S

40-3196 5³/₄" Side Cut



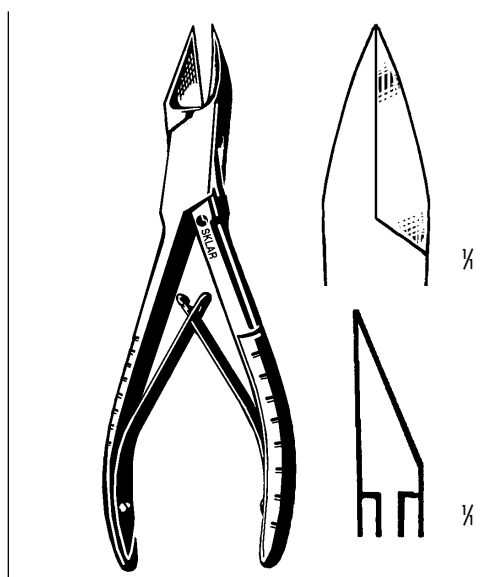
RONGEUR NO. 5

40-3198 6¹/₂" Side Cut



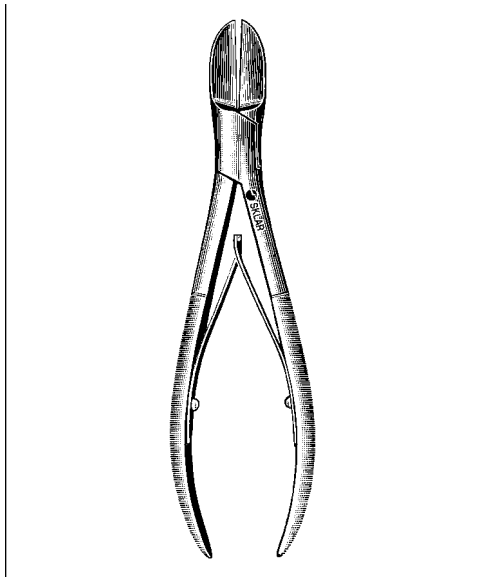
PNA FORCEPS

97-1340 4¹/₂"



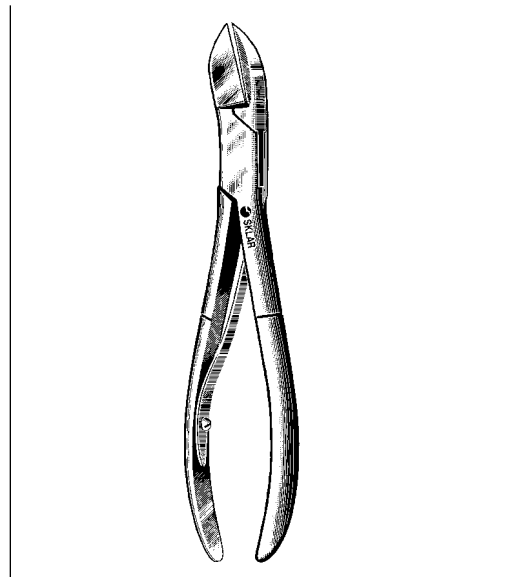
LISTON BONE FORCEPS

Sharp Points
40-3040 5¹/₂" Stainless



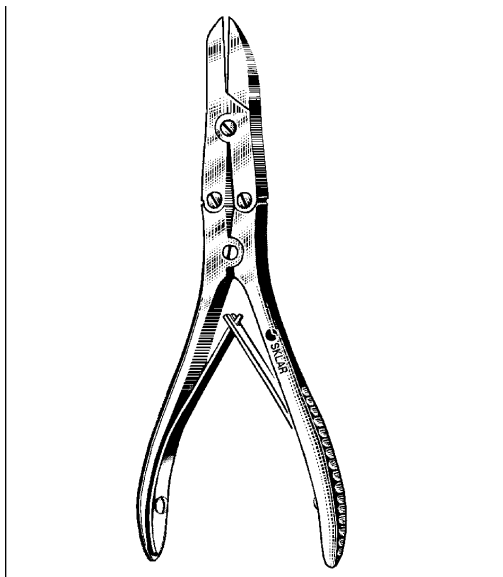
LISTON BONE FORCEPS

40-3055 5½" Straight
 40-3077 7¾" Straight
 40-3087 8¾" Straight



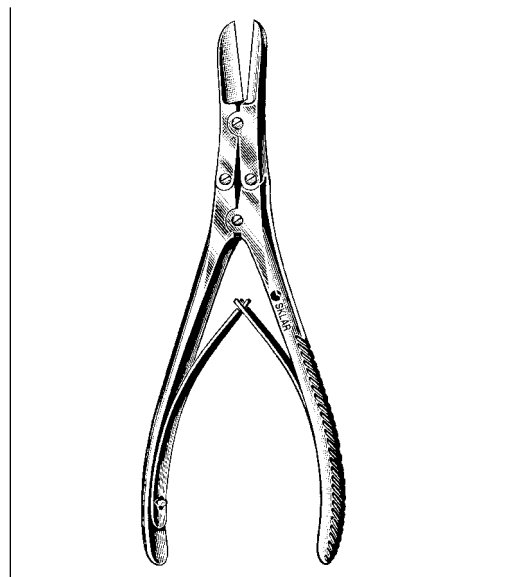
LISTON BONE FORCEPS

40-3155 5½" Angular
 40-3177 7¾" Angular
 40-3187 8¾" Angular



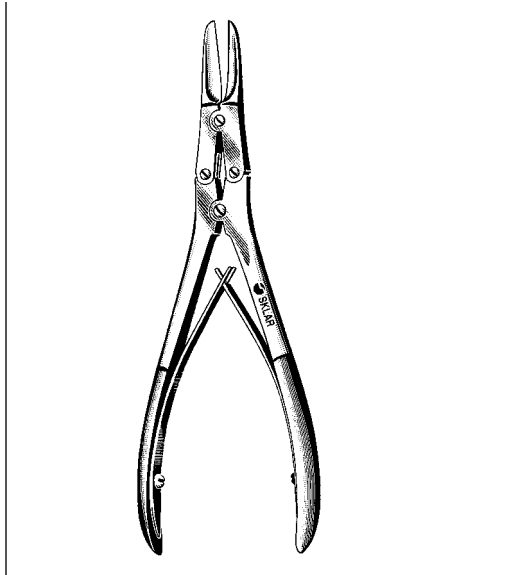
RUSKIN LISTON

Double Action
 40-4560 6" Straight



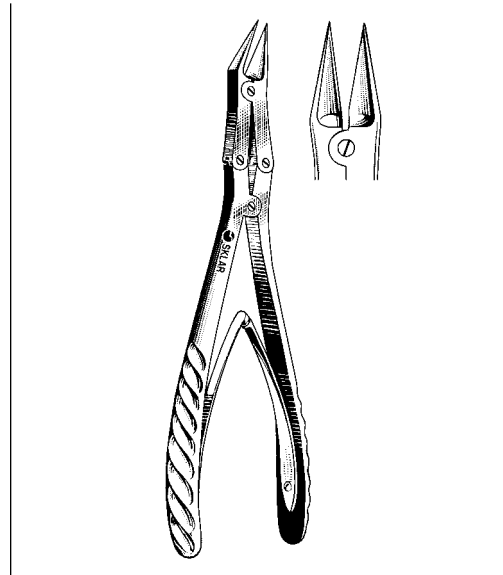
RUSKIN SPLITTING FORCEPS

Double Action
 40-4572 7¼" Straight



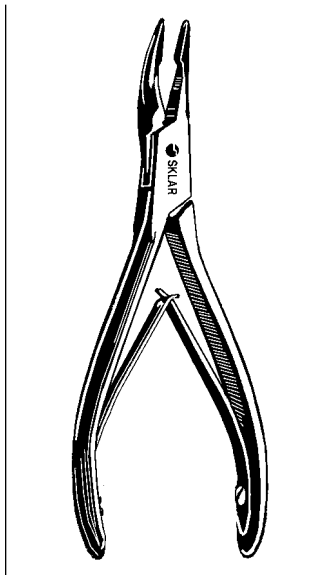
ROWLAND BONE FORCEPS

Double Action
41-1175 7" Narrow Jaws



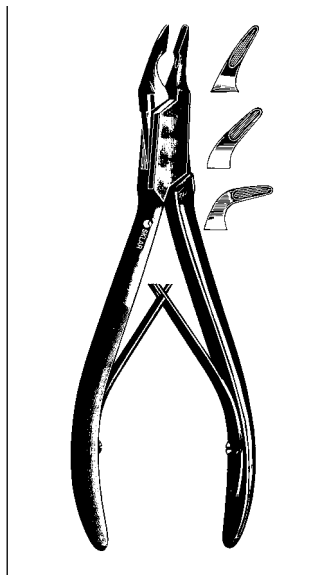
McINDOE BONE CUTTING FORCEPS

Double Action
41-1170 7½" Slight Angle



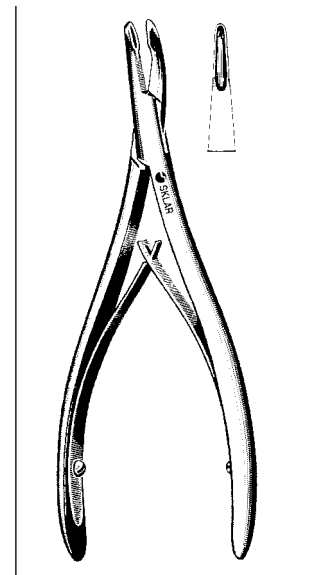
MINI BLUMENTHAL

Delicate
67-5987 4½" 11.5 cm



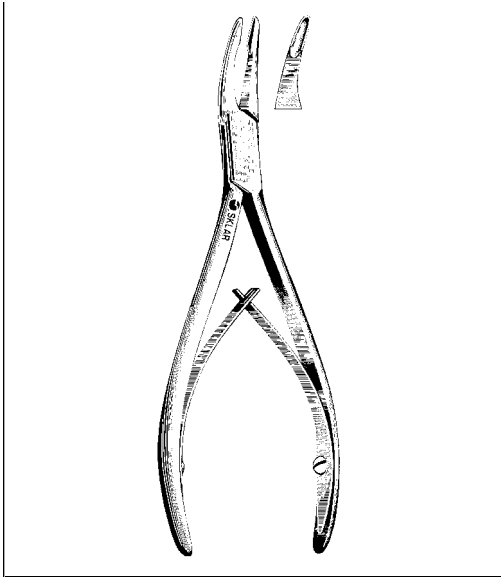
BLUMENTHAL

6" 15.2 cm
67-5990 30° Standard
67-5991 45° Angle
67-5992 90° Angle



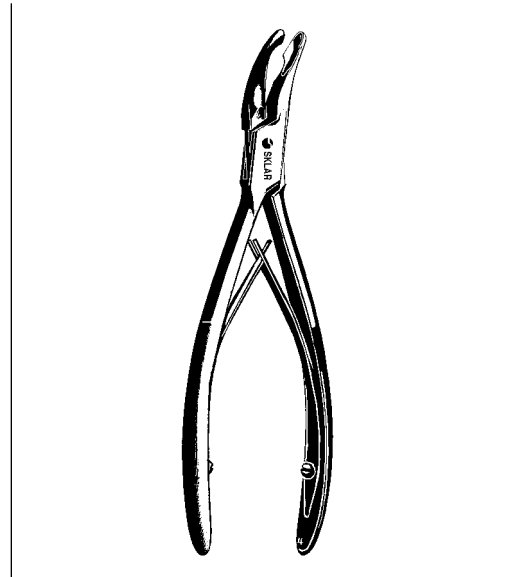
LEMPERT RONGEUR

6¼" Delicate
47-2467 2.5mm Straight
47-2468 2.5mm Curved



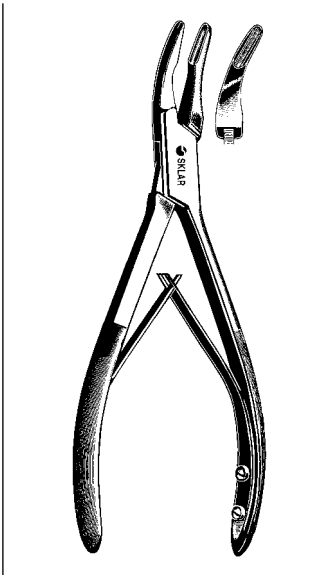
**FRIEDMAN BONE
RONGEUR**

Delicate
40-3190 5½" Curved
40-3192 6½" Curved



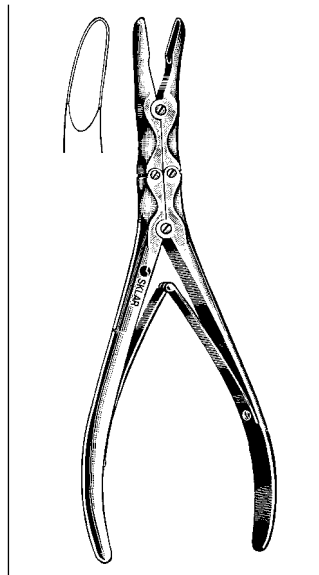
RONGEUR CURVED

40-3200 5½" #4
40-3202 6½" #4A



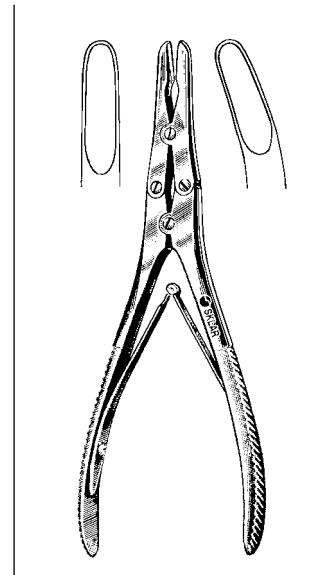
MEAD RONGEUR

40-3206 #10 (1A)



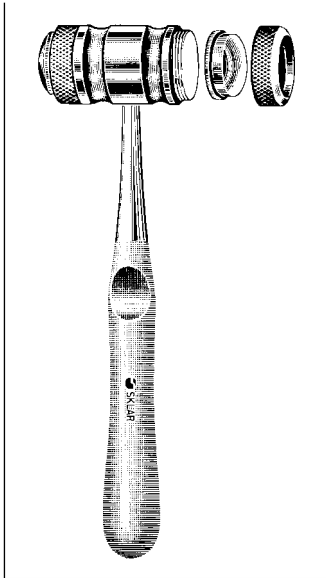
**ZAUFEL-JANSEN
RONGEUR**

Double Action
40-4265 7"



RUSKIN RONGEUR

Double Action
40-4272 7¼" Straight
40-4372 7¼" Curved

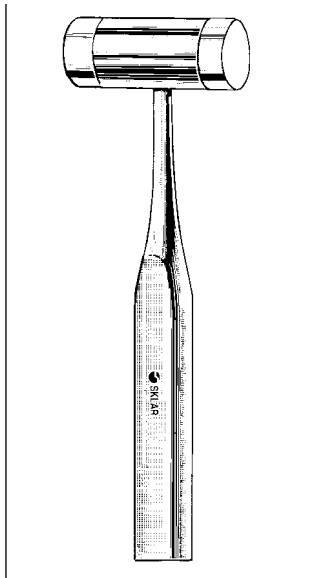


SKLAR MALLET (MEAD)

With Replaceable Plastic Discs

40-5870 Rounded Surfaces

40-5871 Replaceable Discs

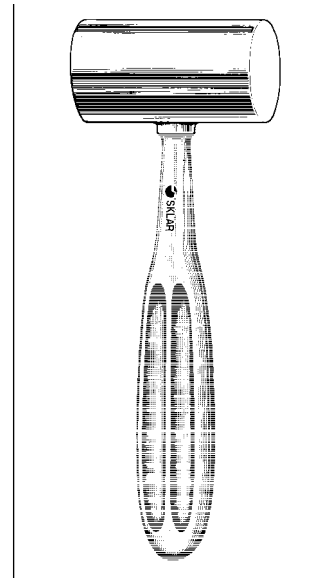


MALLET WITH TWO PLASTIC ENDS

Replaceable

40-5925 Flat Surfaces

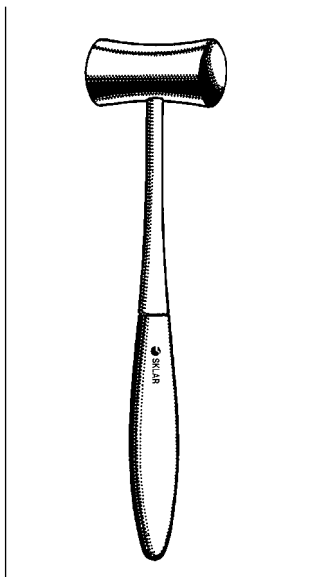
40-5926 Replaceable Ends



KIRK BONE MALLET

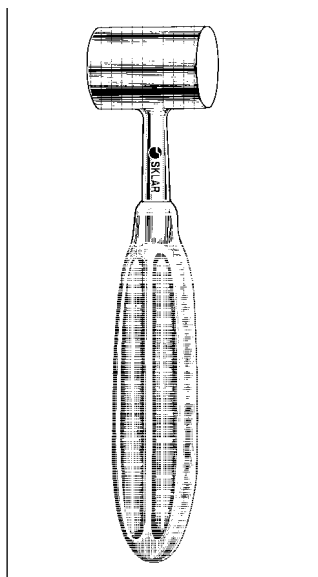
Solid Bronze Head—26 oz.

40-5672 7¼" 1½" Diameter



LUCAE MALLET

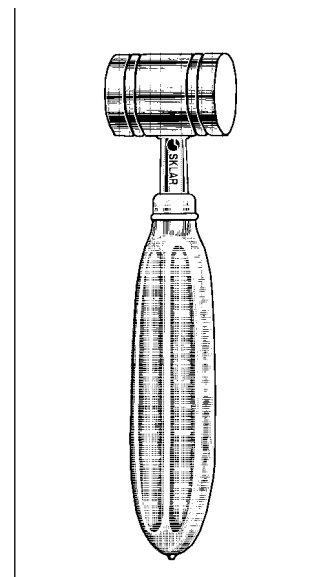
40-5875 7½" 9 oz. Solid Stainless



GERZOG BONE MALLET

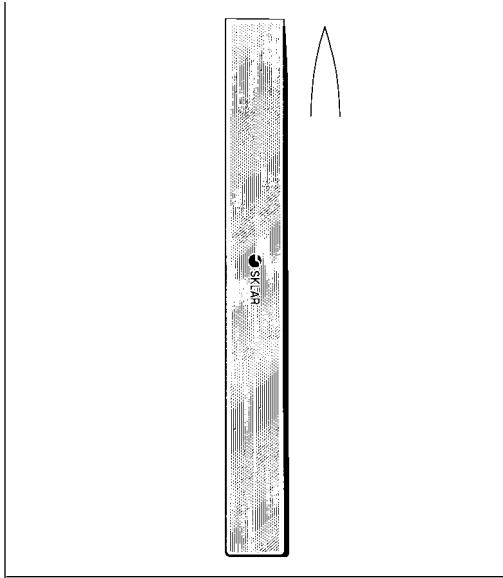
Lead Filled—14 oz.

40-5765 7½" 1" Diameter



RUSH MALLET (CRANE)

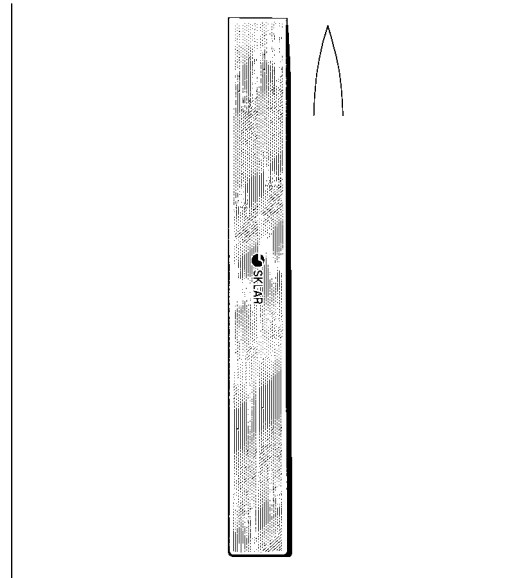
40-5665 1½" Diameter



LAMBOTTE OSTEOTOME

Straight Delicate 5"

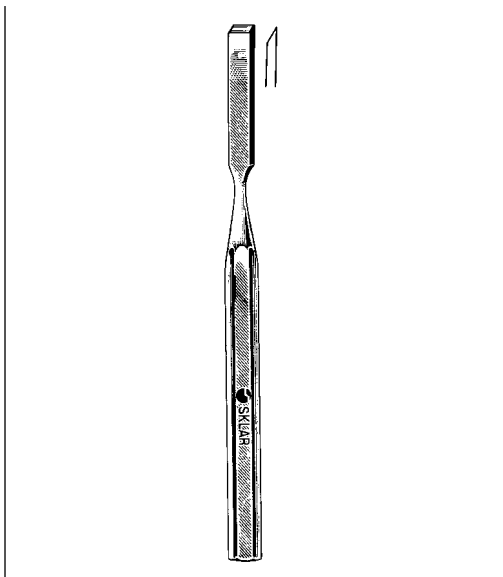
40-6532	2 mm- $\frac{3}{64}$ "	40-6542	12 mm- $\frac{1}{2}$ "
40-6534	4 mm- $\frac{5}{32}$ "	40-6544	14 mm- $\frac{1}{16}$ "
40-6536	6 mm- $\frac{1}{4}$ "	40-6548	18 mm- $\frac{3}{32}$ "
40-6538	8 mm- $\frac{7}{16}$ "	40-6550	20 mm- $\frac{5}{16}$ "
40-6540	10 mm- $\frac{3}{8}$ "	40-6552	Set of 9 2 mm-20 mm



JR. LAMBOTTE OSTEOTOME

Straight 7"

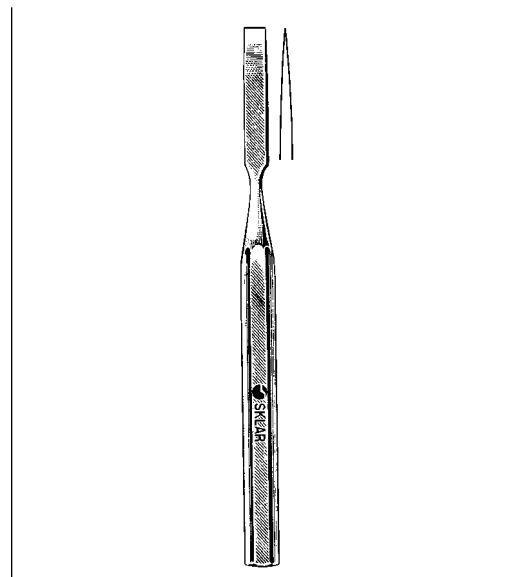
40-6624	4 mm- $\frac{3}{32}$ "	40-6632	12 mm- $\frac{1}{2}$ "
40-6625	5 mm- $\frac{1}{16}$ "	40-6636	16 mm- $\frac{5}{8}$ "
40-6626	6 mm- $\frac{1}{4}$ "	40-6639	19 mm- $\frac{3}{4}$ "
40-6628	8 mm- $\frac{5}{16}$ "	40-6642	22 mm- $\frac{7}{8}$ "
40-6630	10 mm- $\frac{3}{8}$ "	40-6645	25 mm-1"



HOKE CHISEL

Straight 5 1/2"

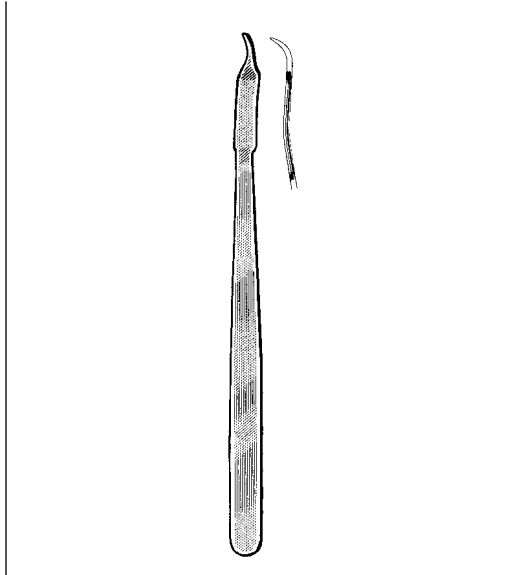
40-6984	4 mm- $\frac{5}{32}$ "
40-6986	6 mm- $\frac{1}{4}$ "
40-6990	9 mm- $\frac{23}{64}$ "
40-6993	13 mm- $\frac{1}{2}$ "
40-6984	16 mm- $\frac{5}{8}$ "
40-6986	19 mm- $\frac{3}{4}$ "



HOKE OSTEOTOME

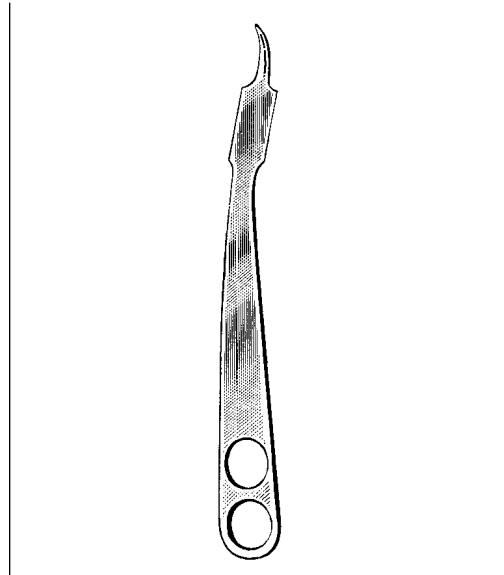
Straight 5 1/2"

40-6953	3 mm- $\frac{1}{8}$ "	40-6970	10 mm- $\frac{3}{8}$ "
40-6954	4 mm- $\frac{5}{32}$ "	40-6973	13 mm- $\frac{1}{2}$ "
40-6956	6 mm- $\frac{1}{4}$ "	40-6976	16 mm- $\frac{5}{8}$ "
40-6958	8 mm- $\frac{3}{16}$ "	40-6979	19 mm- $\frac{3}{4}$ "



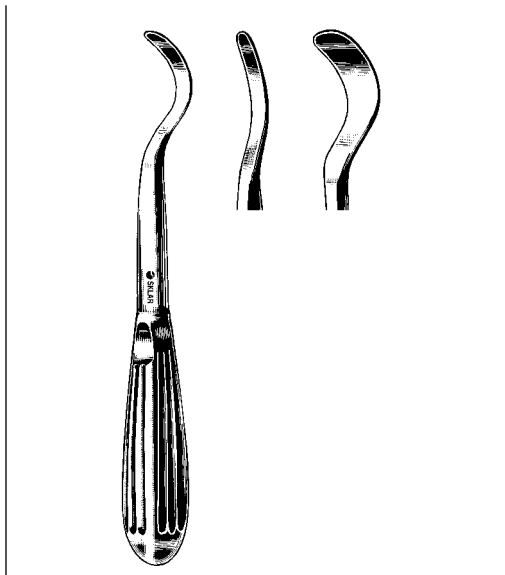
MINI HOHMANN BONE ELEVATOR

40-7450	6½" x 6 mm	6 mm-¼"
40-7451	6½" x 8 mm	8 mm-⅝"



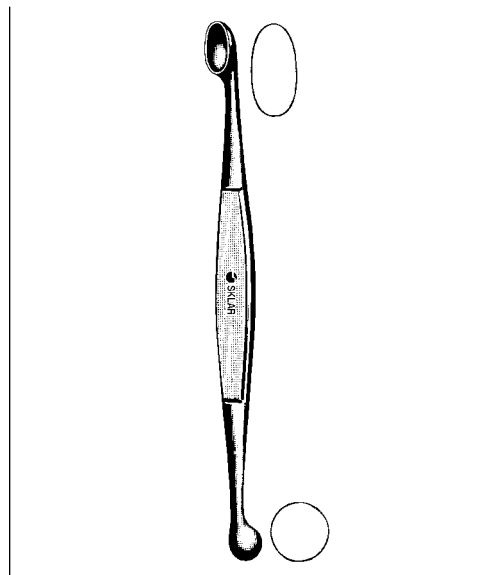
HOHMANN BONE ELEVATOR

40-7452	9" x 18 mm	18 mm-¾"
40-7453	9½" x 43 mm	43 mm-1¾"
40-7454	10¾" x 24 mm	24 mm-1⅝"



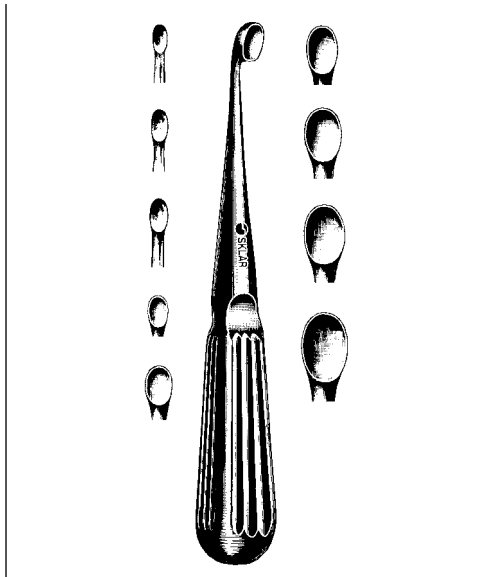
CREGO ELEVATOR

40-7410	7¼" x ⅝"	Full Curve	9.5 mm-⅝"
40-7415	7¾" x ¼"	Full Curve	6.35 mm-¼"
40-7420	7¾" x ¼"	Slight Curve	6.35 mm-¼"



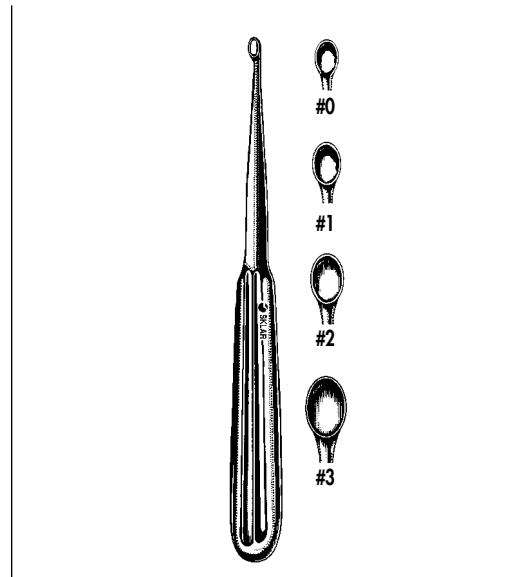
VOLKMAN CURETTE

Double End		
40-7250	5"	Oval/Round
40-7265	6½"	Oval/Round
40-7280	8"	Oval/Round



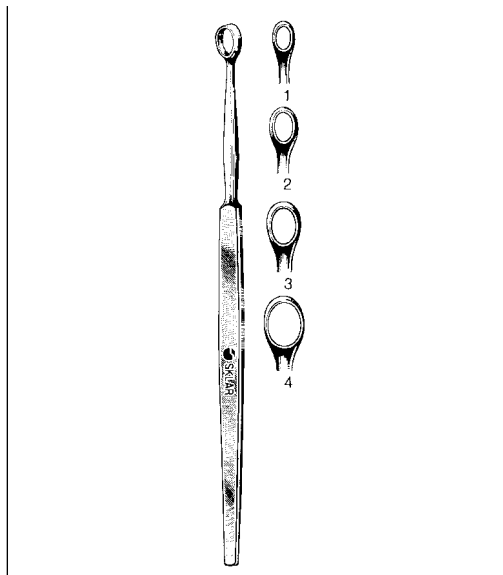
BRUNS CURETTE

Single End-Oval	Straight 6½"		
40-7118	#5-0	40-7113	#3
40-7120	#4-0	40-7114	#4
40-7000	#3-0	40-7115	#5
40-7100	#2-0	40-7116	#6
40-7110	#1-0		
40-7111	#1		
40-7112	#2		



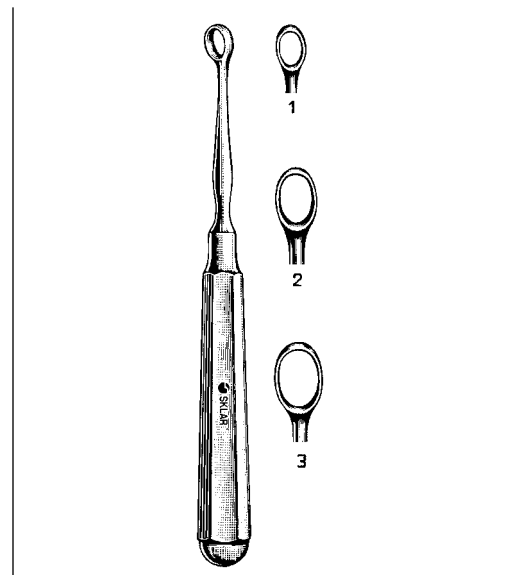
SKLAR DERMAL CURETTE

6¼" Oval	
06-4112	#0
06-4113	#1
06-4114	#2
06-4115	#3



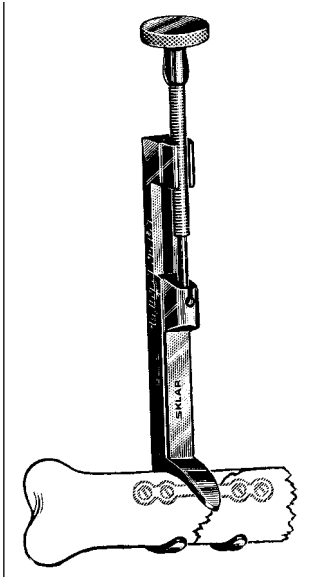
FOX DERMAL CURETTE

Oval 5½"		Round 5½"	
06-4133	3 mm	06-4138	3 mm
06-4134	4 mm	06-4139	4 mm
06-4135	5 mm	06-4140	5 mm
06-4136	6 mm	06-4141	6 mm



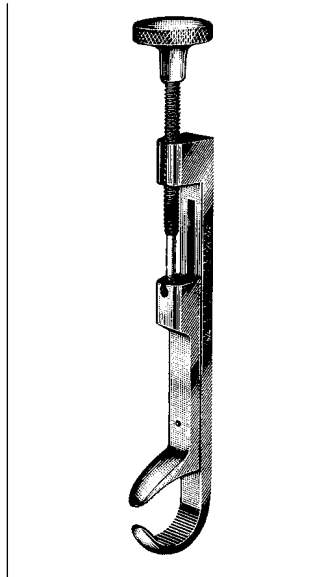
PIFFARD CURETTE

06-4130	#1
06-4131	#2
06-4132	#3



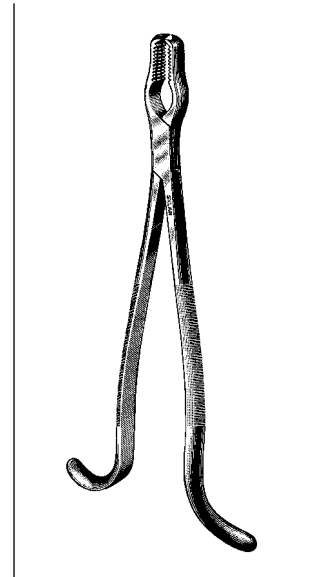
LOWMAN CLAMP

1x2 Prongs
 40-2921 4³/₄" x 3³/₄" Jaw
 40-2922 7¹/₄" x 1¹/₈" Jaw



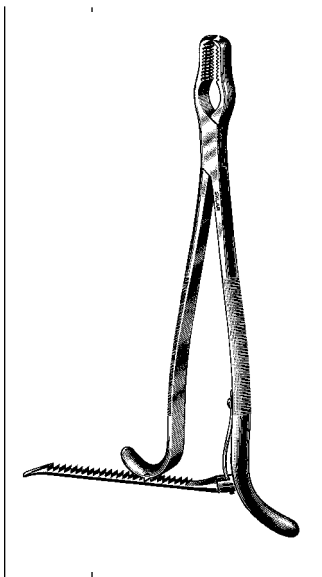
LOWMAN CLAMP

1x1 Prongs
 40-2925 4³/₄" x 3³/₄" Jaw
 40-2927 7¹/₄" x 1¹/₈" Jaw



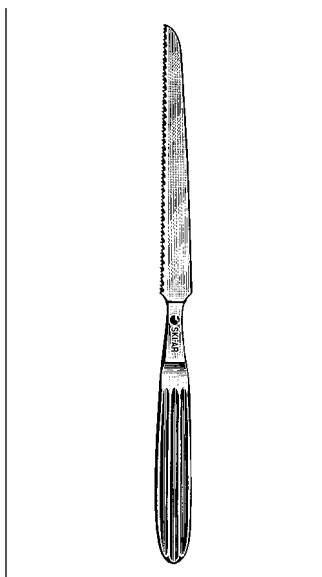
KERN BONE HOLDING FORCEPS

Without Ratchet
 40-2480 5³/₄" Extra Small



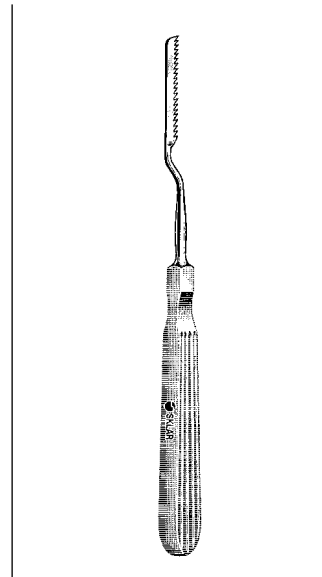
KERN BONE HOLDING FORCEPS

With Ratchet
 40-2580 5³/₄" Extra Small



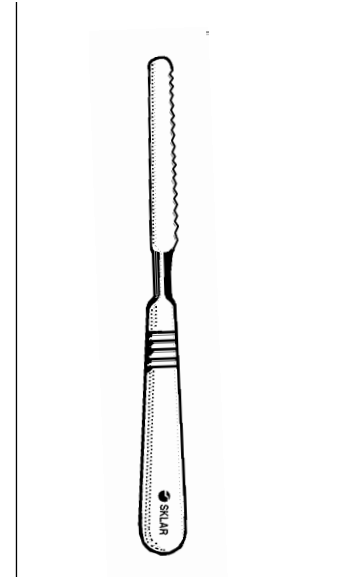
LAGENBECK BONE SAW

40-5395 9¹/₂"



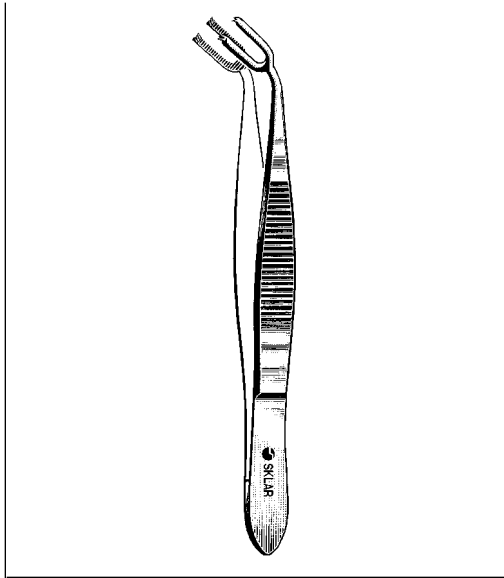
JOSEPH BONE SAW

Bayonet
 70-7801 7"



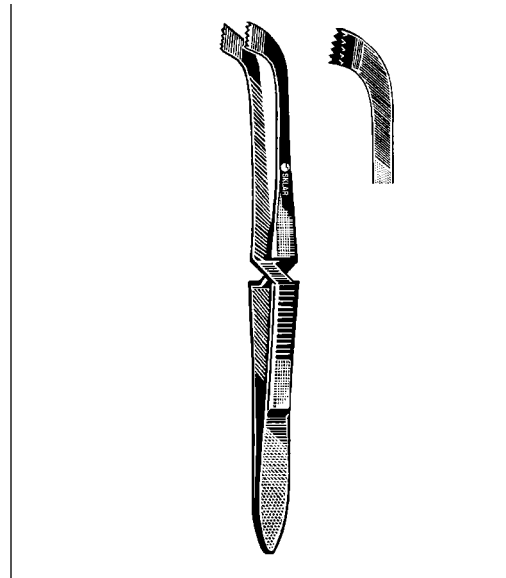
BONE SAW

Straight
 40-1515 5"



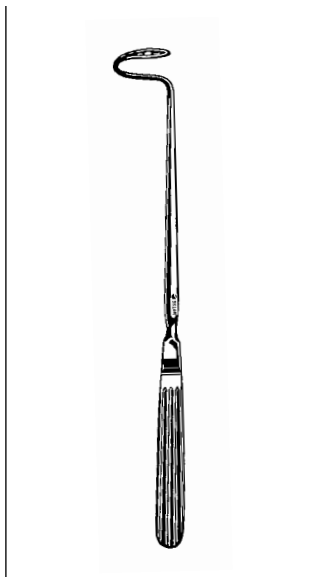
KING WOUND FORCEPS

19-2926 5½" Angular, U-shaped jaws



JAMES WOUND FORCEPS

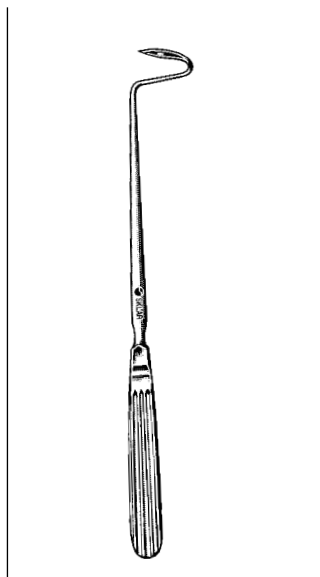
19-2925 5" Cross Action



DESCHAMP NEEDLE

Blunt

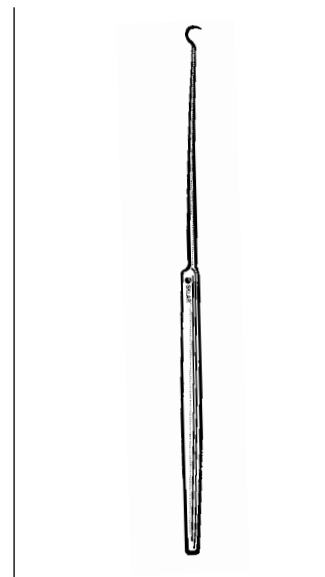
26-1280 8" Curved Right
26-1380 8" Curved Left



DESCHAMP NEEDLE

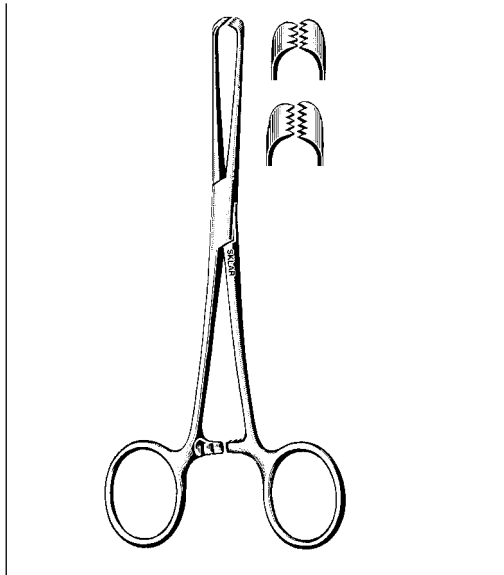
Sharp

26-1480 8" Curved Right
26-1580 8" Curved Left



LIGATURE NEEDLE

26-1640



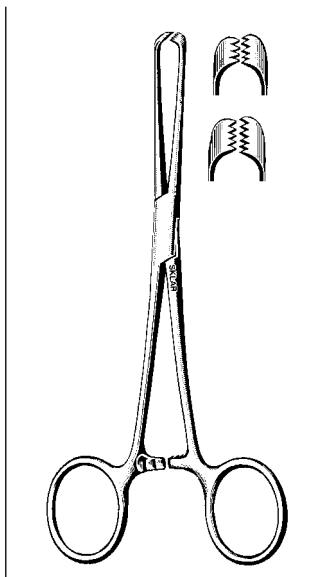
ALLIS TISSUE FORCEPS

- 36-2060 6" 3 x 4
- 36-2160 6" 4 x 5
- 36-2260 6" 5 x 6
- 36-2275 7½" 5 x 6
- 36-2295 9½" 5 x 6



SKLARLITE™ ALLIS TISSUE FORCEPS

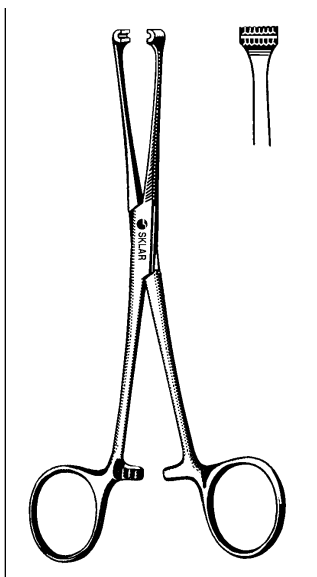
- 23-2851 6" 4 x 5



ALLIS TISSUE FORCEPS

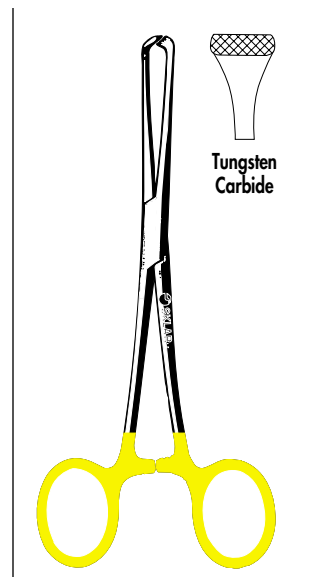
Delicate

- 18-2140 4" 4 x 5
- 18-2155 5" 4 x 5
- 18-6157 5½" 4 x 5
- 18-2162 6" 4 x 5
- 18-2164 6" 5 x 6



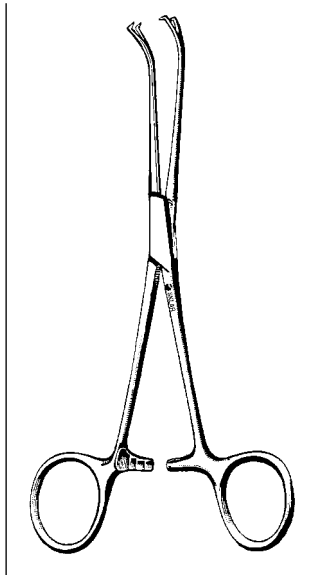
NON-TRAUMATIC ALLIS FORCEP

- Double Row Non-Traumatic Teeth
- 36-2298 6"
- 90-2385 10"



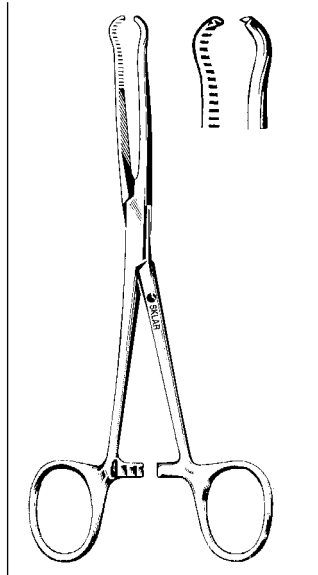
NON-TRAUMATIC ALLIS FORCEP

- 97-1555 6" Tungsten Carbide



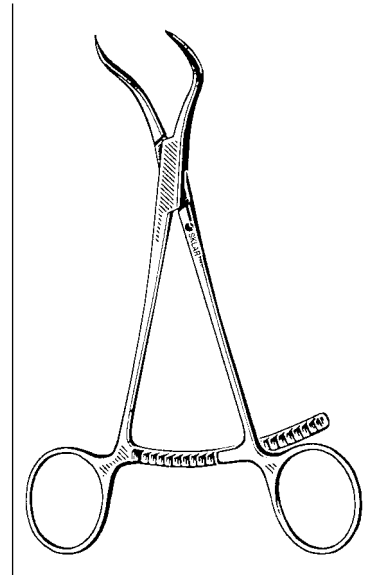
SESAMOID CLAMP

40-2655 5¾"



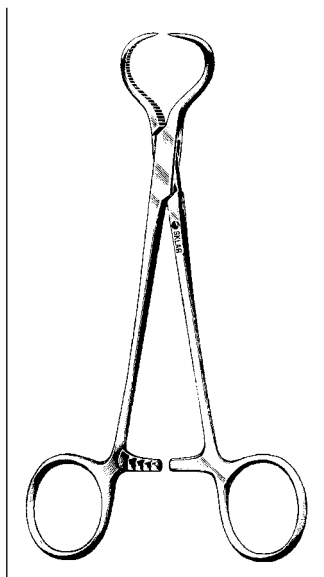
**LOCKE PHALANGEAL
FORCEPS**

40-2650 6"



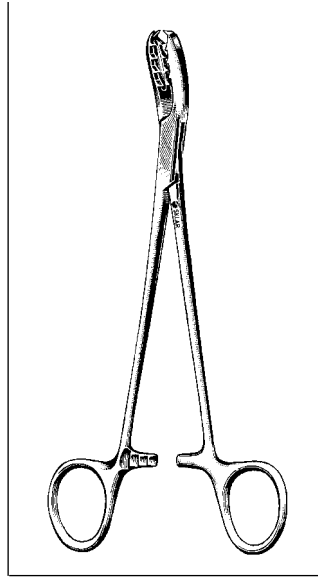
**BONE COMPRESSION
FORCEPS**

40-2675 5½" Pointed Tips



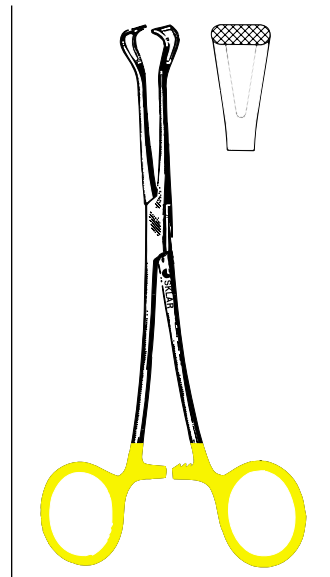
LEWIN BONE FORCEPS

40-2670 7" Serrated



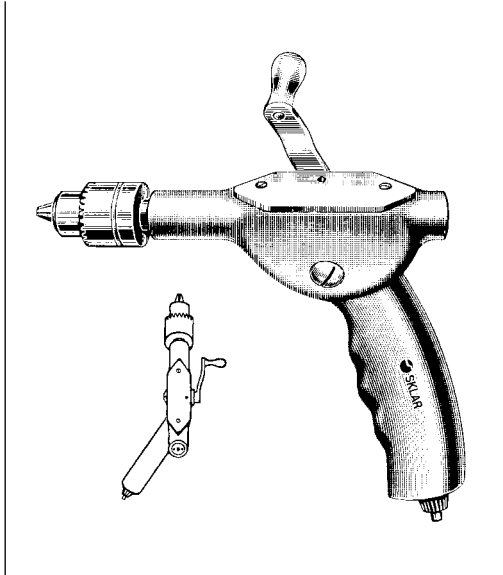
**BONE AND CARTILAGE
CLAMP**

40-2275 8" Curved



T-C BABCOCK FORCEPS

97-1565 6¼" Tungsten Carbide
97-1570 8" Tungsten Carbide

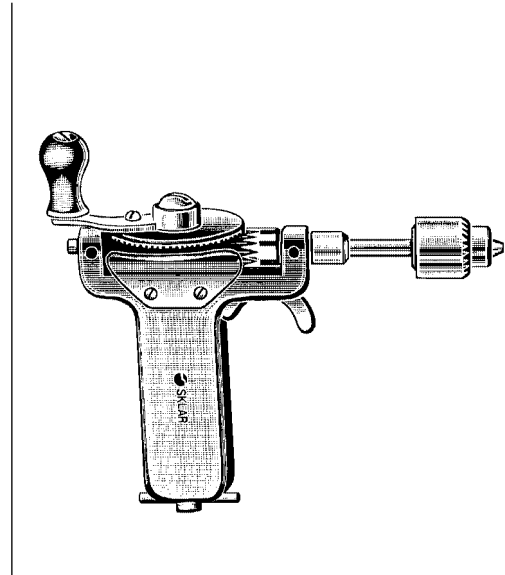


SKLAR BONE DRILL-OFFSET HANDLE

With Jacobs Chuck

40-1465 For Twist Drills and Kirschner Wires

40-1478 Chuck Key Only

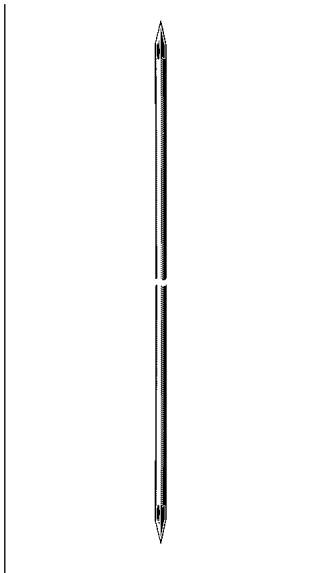


BUNNELL DRILL-CANNULATED

With Jacobs Chuck

40-1475 For Twist Drills and Kirschner Wires

40-1478 Chuck Key Only



KIRSCHNER WIRES

Two Trocar Ends

40-1535 12" x .035 40-1567 4" x .045

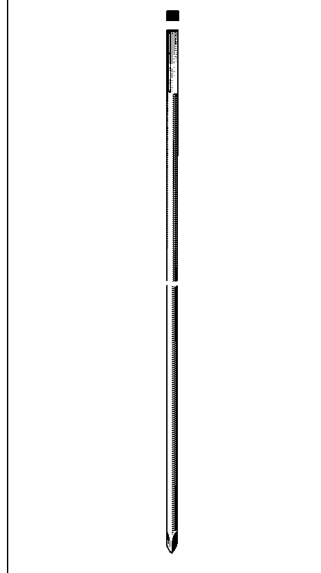
40-1545 12" x .045 40-1568 4" x .054

40-1562 12" x .062 40-1569 4" x .062

40-1565 4" x .028 40-1580 9" x .035

40-1566 4" x .035 40-1582 9" x .045

40-1584 9" x .062



STEINMANN PINS

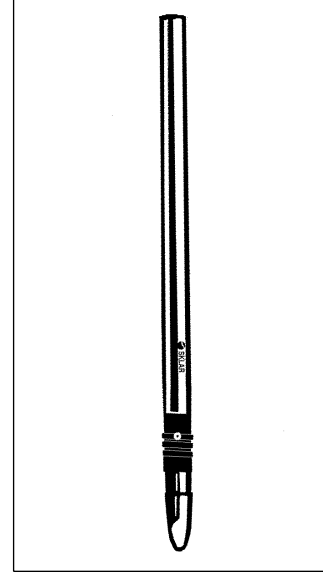
Trocar Point

40-1590 9" x 2 mm 40-1594 9" x 3.5 mm

40-1591 9" x 2.4 mm 40-1595 9" x 4.0 mm

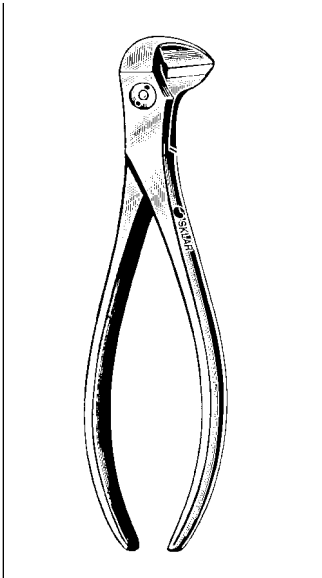
40-1592 9" x 2.8 mm 40-1596 9" x 4.5 mm

40-1593 9" x 3.2 mm



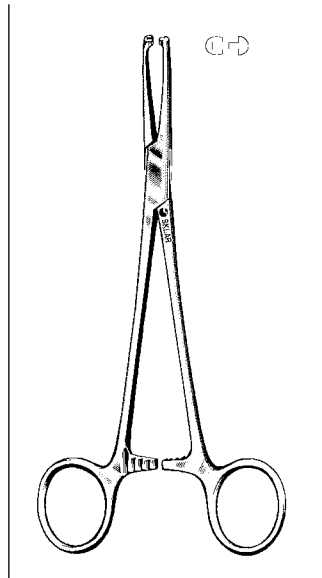
K WIRE DRIVER

40-1650



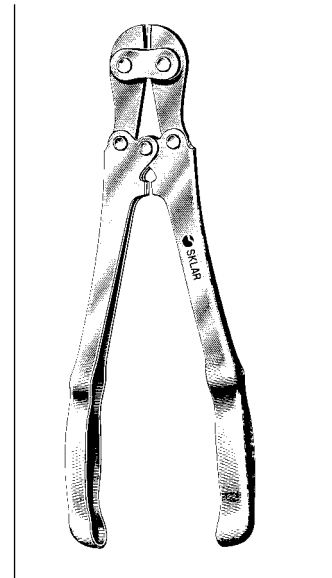
**IMPROVED SKLAR
FORCEPS**

For Cutting and Shaping Wire
75-9550



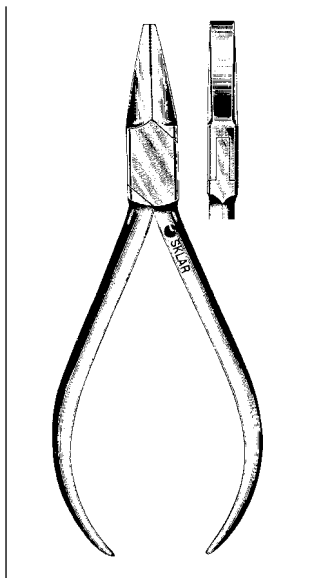
WIRE TIGHTENER

50-3970 7"



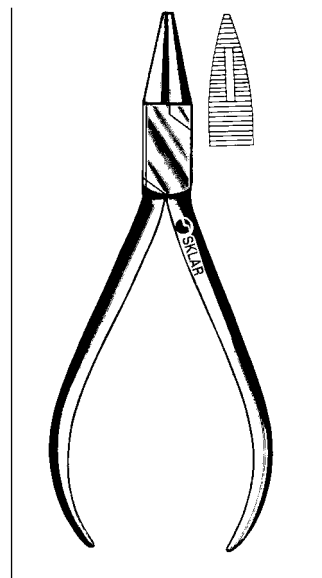
**DOUBLE ACTION PIN
CUTTER**

Chrome
40-1715 15" Cuts up to $\frac{5}{32}$ "
40-1716 Replacement Blades



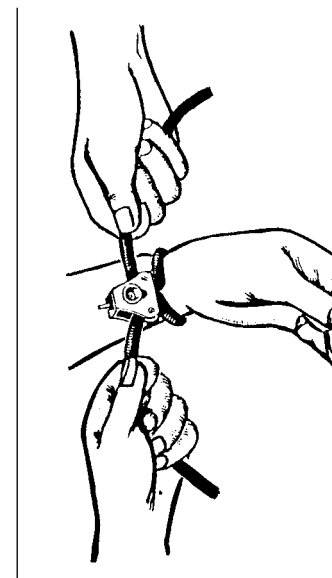
SQUARE END PLIERS

40-1778 $5\frac{1}{2}$ " Flat Nose



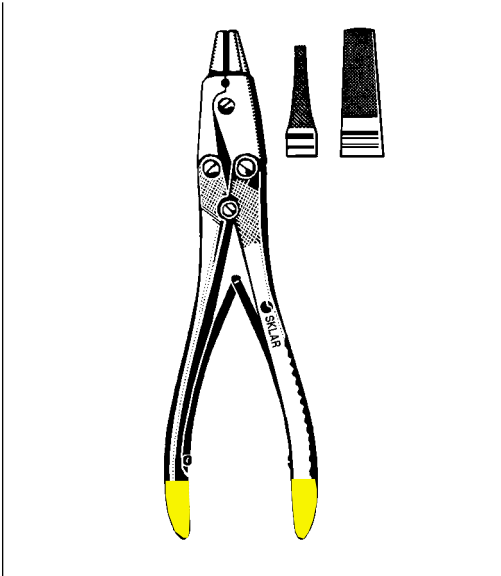
NEEDLE NOSE PLIERS

40-1775 $5\frac{1}{2}$ "



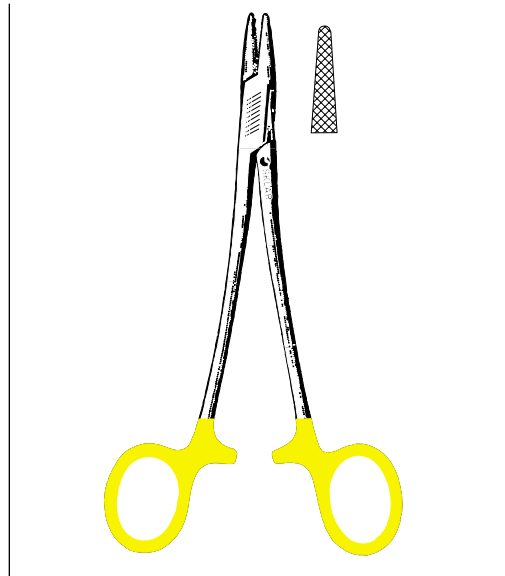
**N-I AUTOMATIC
TOURNIQUET**

Black Tubing
40-1915 Complete
40-1916 Black Tubing Only
White Tubing
40-1918 Complete
40-1919 White Tubing Only



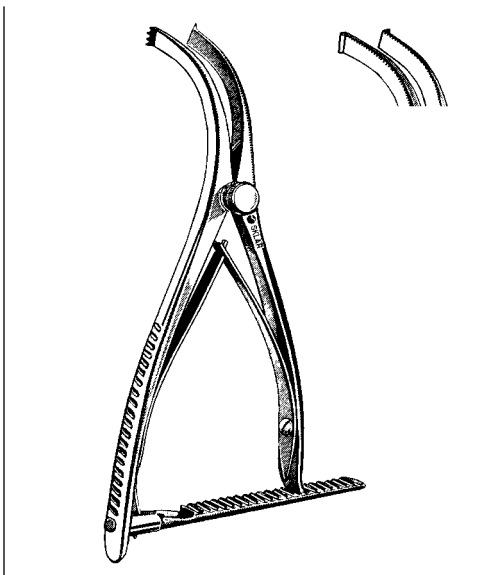
T-C DOUBLE ACTION WIRE EXTRACTION PLIERS

40-1744 Narrow 7" Tungsten Carbide
40-1745 Wide 7" Tungsten Carbide



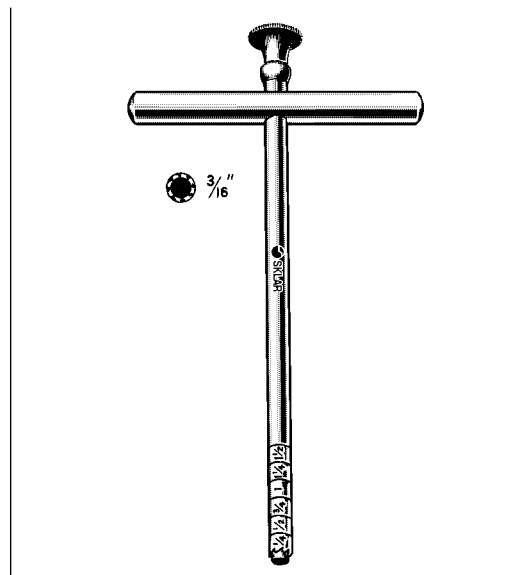
T-C RING HANDLE PIN AND WIRE EXTRACTOR

40-1720 Tungsten Carbide 7"



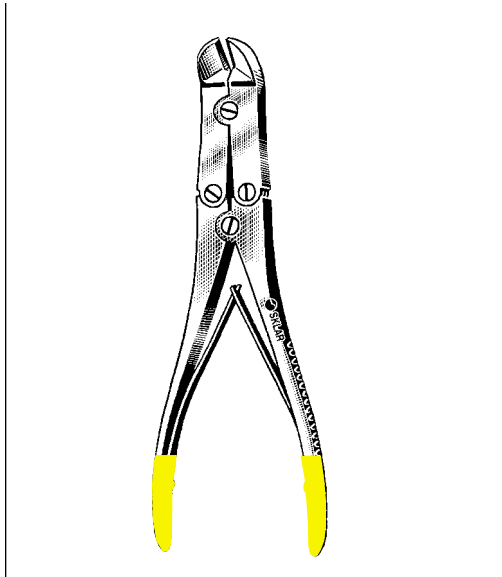
INGE SPREADER

42-1420 6½" With Teeth
42-1422 6½" Without Teeth
42-1425 10½"



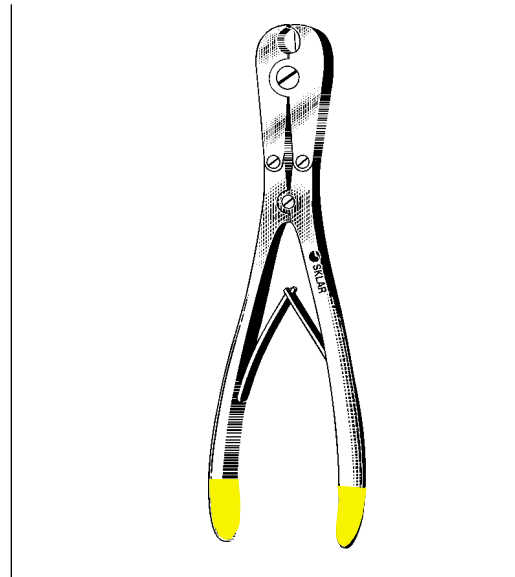
P.I. PLUG CUTTER WITH OBTURATOR

42-2701 3/16" (Michele Trephine)



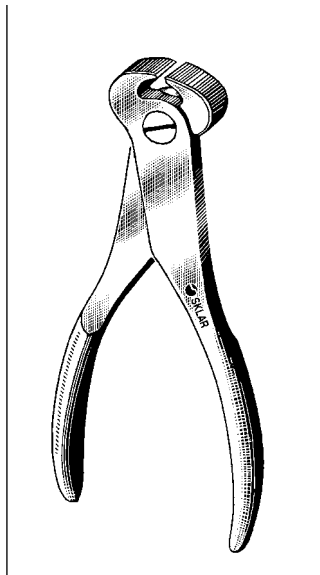
T-C PIN CUTTER SIDE CUT

Double Action
Cuts to $\frac{3}{32}$ " Wire (2.5 mm)
40-1023 7" Straight Tungsten Carbide
40-1024 $8\frac{3}{4}$ " Angular Tungsten Carbide



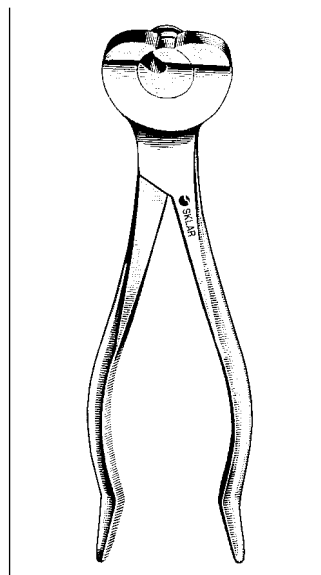
T-C PIN CUTTER

Double Action
Cuts to .062" Wire (16 mm)
40-1045 7" End Cut-Side Cut Tungsten Carbide



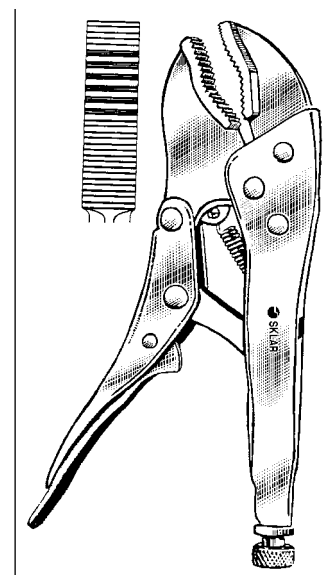
SKLAR PIN CUTTER

End Cutting
40-1048 7"



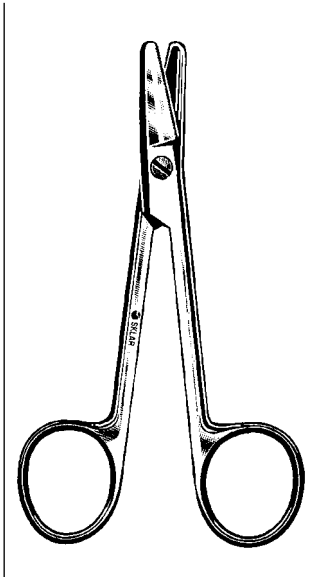
DIAMOND PIN CUTTER

Chrome
40-1762 $6\frac{1}{4}$ "



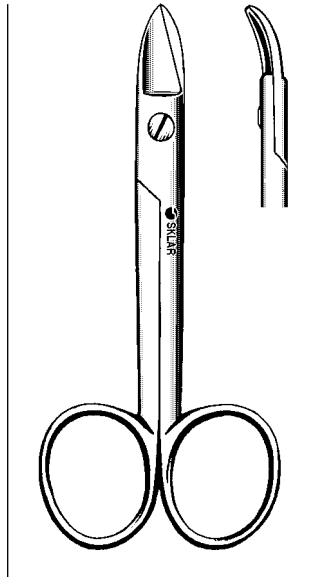
SNAP LOCK PIN/WIRE EXTRACTOR

40-1725



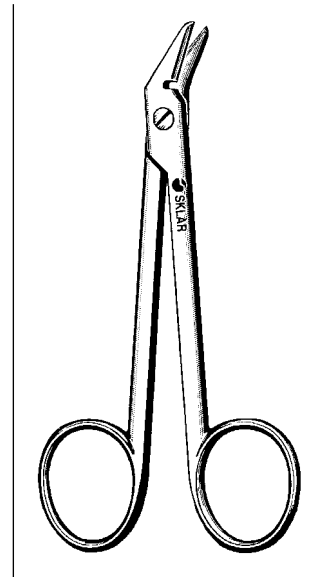
SUTURE WIRE CUTTING SCISSORS

24-2347 4 3/4" Straight,
Serrated Edges



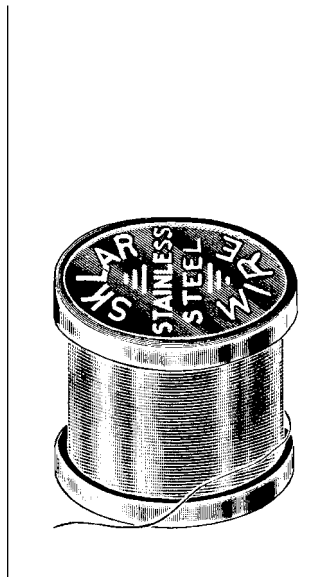
CROWN & COLLAR CUTTING SCISSORS

Straight	Curved
24-2345 4" Smooth	24-2346 4" Smooth
24-2340 4" Serr	24-2341 4" Serr



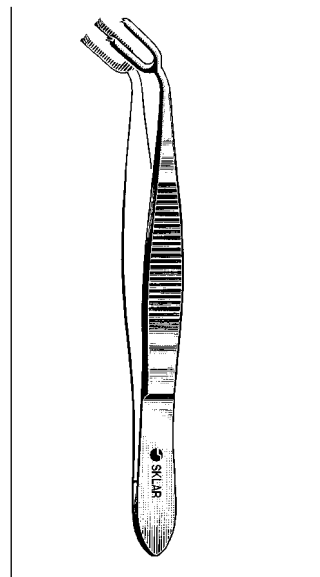
SUTURE WIRE CUTTING SCISSORS

Angular Serrated	Tungsten Carbide
24-2342 4 3/4"	Angular Serrated
	16-2800 4 3/4"



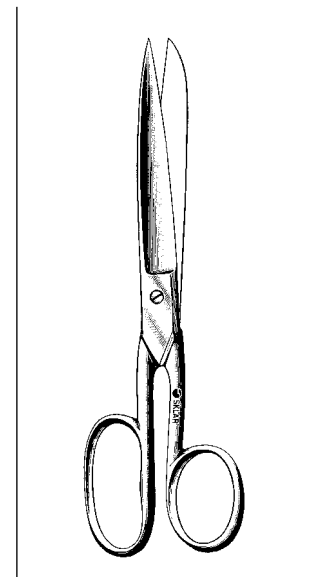
STAINLESS SUTURE WIRE

24-2220	1/4 lb.	20 Gauge
24-2222	1/4 lb.	22 Gauge
24-2224	1/4 lb.	24 Gauge
24-2226	1 oz.	26 Gauge
24-2228	1 oz.	28 Gauge
24-2230	1 oz.	30 Gauge
24-2232	1 oz.	32 Gauge



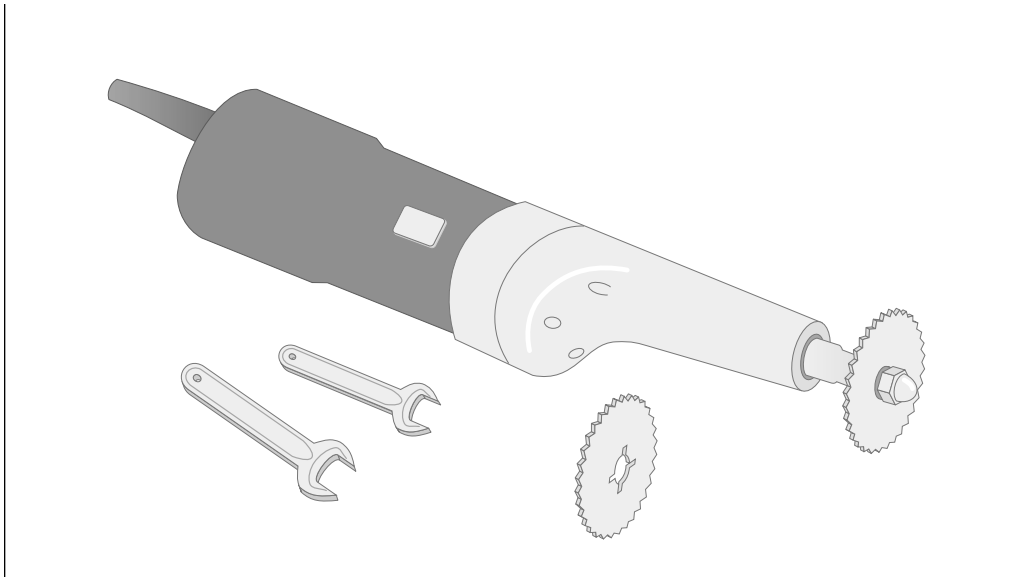
KING FORCEPS

19-2926 5 1/2" Angular Tips



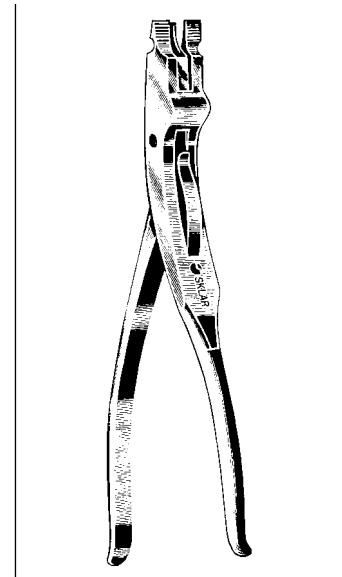
USA PATTERN GAUZE SCISSORS

11-1180 8"



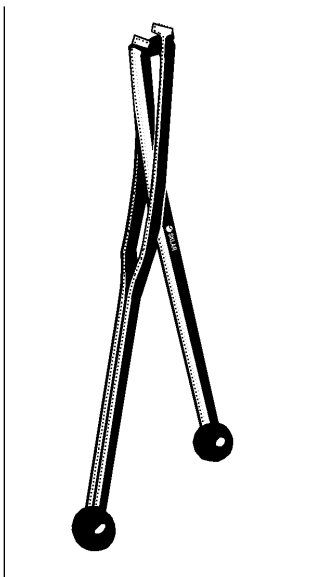
OSCILLATING PLASTER SAW

- 11-2100 110V Complete
- 11-2101 220V Complete
- 11-2105 Blade Only 50 mm
- 11-2110 Blade Only 65 mm
- 11-2115 Wrenches only



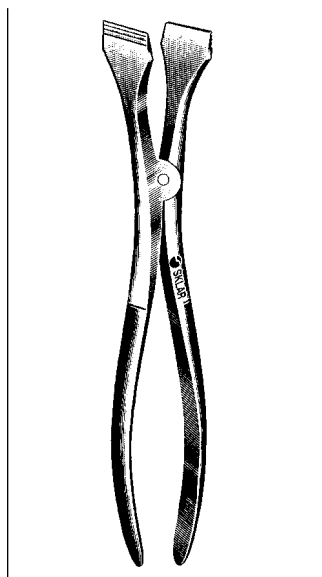
WALTON PLASTER SPREADER

- 3 Blade
- 11-1990 9"



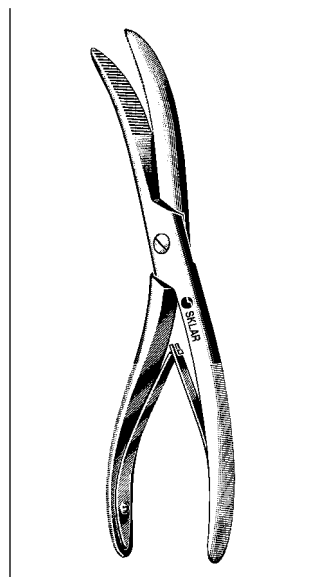
HEAVY DUTY CAST SPREADER

- Martin Pattern
- 11-1995 4" Opening 18½" Long



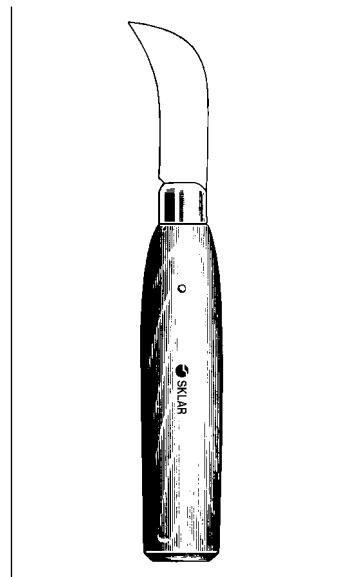
HENNIG PLASTER SPREADER

- 2 Blade
- 11-1910 11"



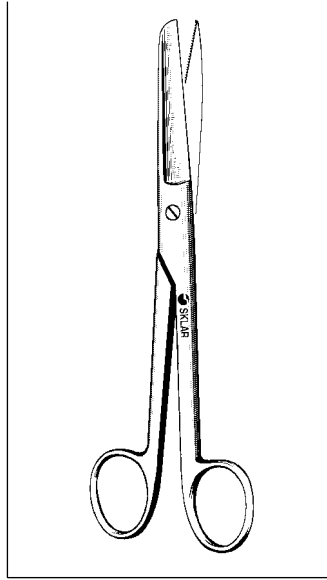
WOLFE-BOEHLER

- Plaster Cast Breaker
- 11-2095 10"



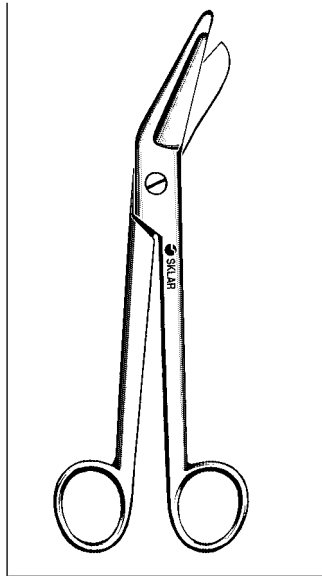
MURPHY PLASTER KNIFE

- Wood Handle
- 11-1540



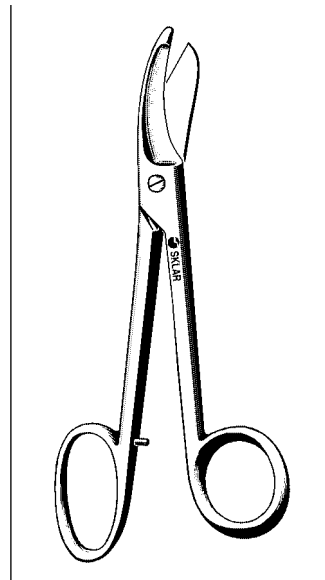
MOLESKIN SCISSORS

One Blade Serrated
 97-1350 7½" Straight S/B
 97-1351 7½" Curved S/B



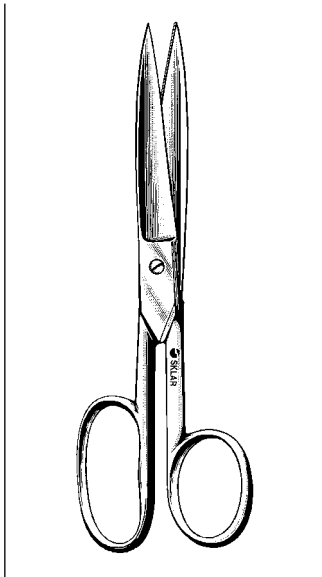
ESMARCH SHEARS

Heavy Pattern
 11-1380 8"
 11-1390 9"



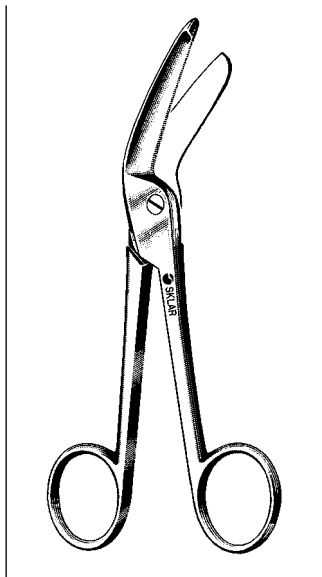
BRUNS SHEARS

Serrated
 11-1295 9¼"



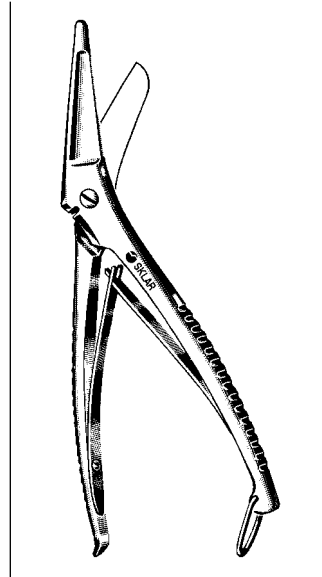
FELT SHEARS

97-1355 8" Serrated Blade



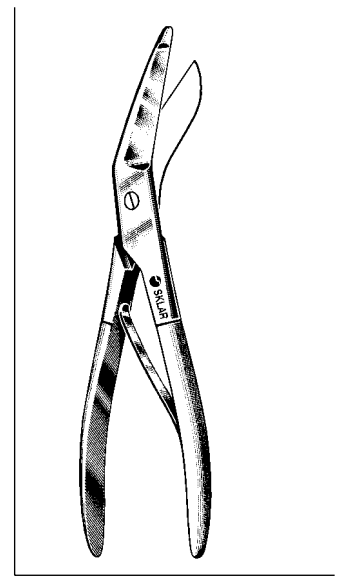
HERCULES UTILITY SCISSORS

11-1297 7½" Serrated



COMMANDER UTILITY SHEARS

Heavy Duty with Wire Cutting Notch
 11-1298 8½"



SEUTIN PLASTER SHEARS

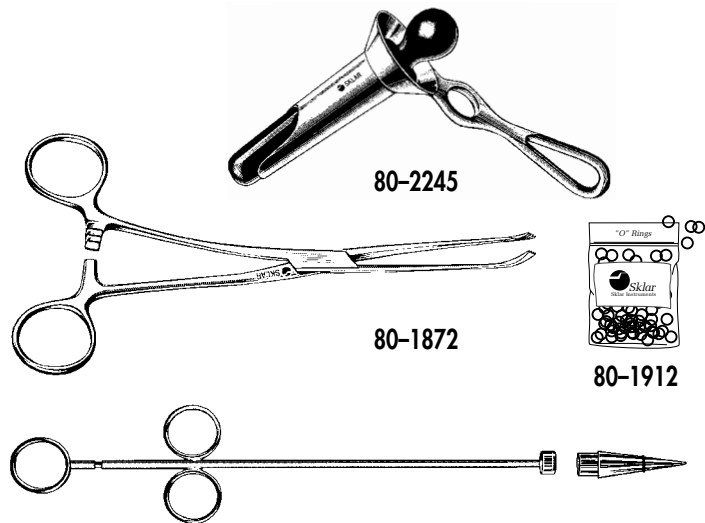
Heavy Plier Handle
 11-1490 9" Serrated

RUDD CLINIC LIGATOR SET

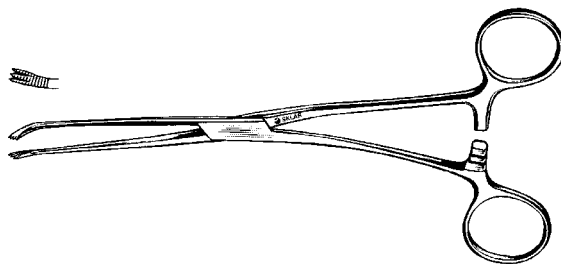
The Rudd Clinic Hemorrhoidal Ligator is an improved instrument for elastic band ("O" Ring) ligation of hemorrhoids. It is simply designed with only one moving part for greater dependability and trouble-free performance. Separate loading cone facilitates loading "O" ring bands on cylinder.

Instead of suddenly releasing the band around entire hemorrhoid, the Rudd Ligator releases the band from one side of applicator for a more gradual encirclement of the hemorrhoid.

This instrument also features a shorter and wider cylinder to allow for use on larger hemorrhoids and mucosal prolapse. It provides better visibility ... before, during and after ligation to assure proper placement of bands.

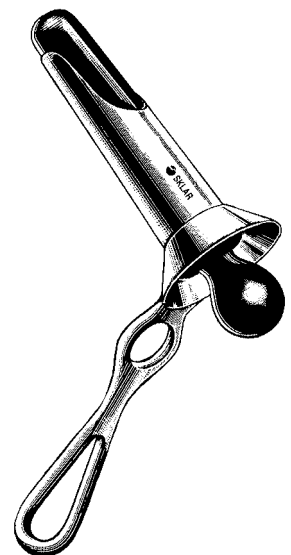


80-1914 Set Includes: Ligator, Forceps, 100 "O" Rings and Speculum



SKLAR HEMORRHOIDAL FORCEPS

80-1872 7¼"



IVES RECTAL SPECULUM (FANSLER)

80-2245 3¼" Long
80-2244 Obturator only



RUDD CLINIC HEMORRHOIDAL LIGATOR

With Loading Cone and 100 'O' Rings

80-1910 Complete
80-1911 Loading Cone Only
80-1912 Ligating 'O' Rings
Package of 100

RECTAL INSTRUMENTS

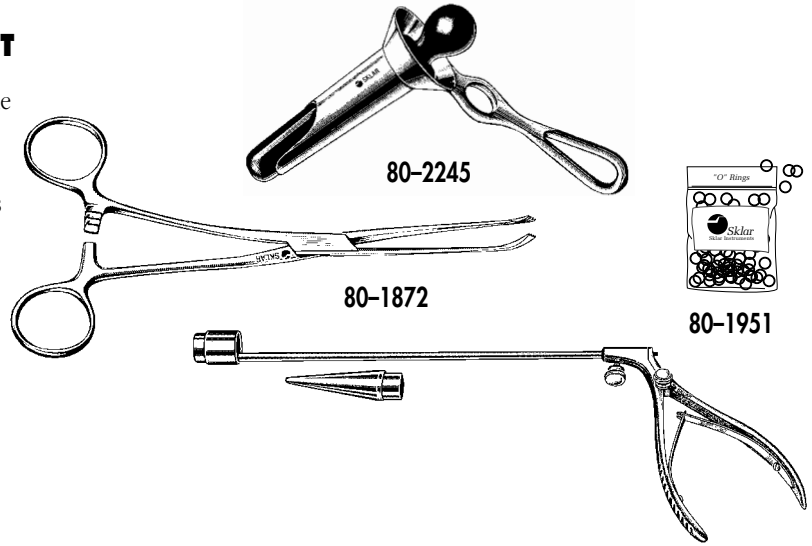


McGIVNEY HEMORRHOIDAL LIGATOR SET

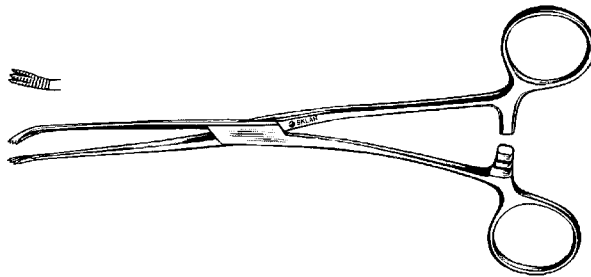
The McGivney Hemorrhoidal Ligator Set provides the convenience of a plier handle elastic band applicator.

- It is supplied with a separate loading cone.
- A specially designed double bend forceps that provides better visualization.
- The Ives (Fansler) Rectal Speculum is the instrument of choice for Ligation procedures.

Also included are 100 elastic "O" Rings that can be reordered as 80-1951.

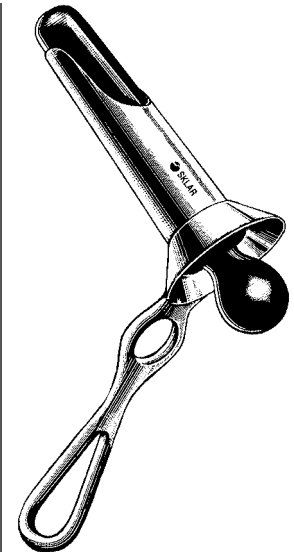
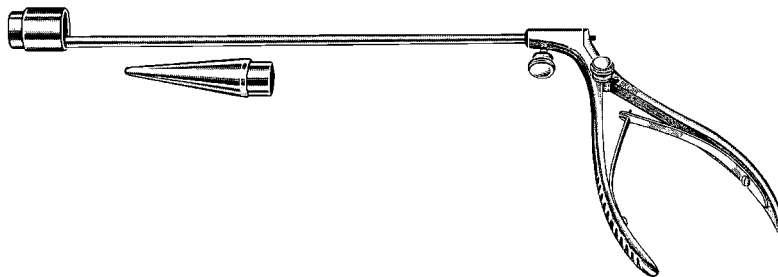


80-1945 Set Includes: Ligator, Forceps, 100 "O" Rings and Speculum



SKLAR HEMORRHOIDAL FORCEPS

80-1872 7 1/4"

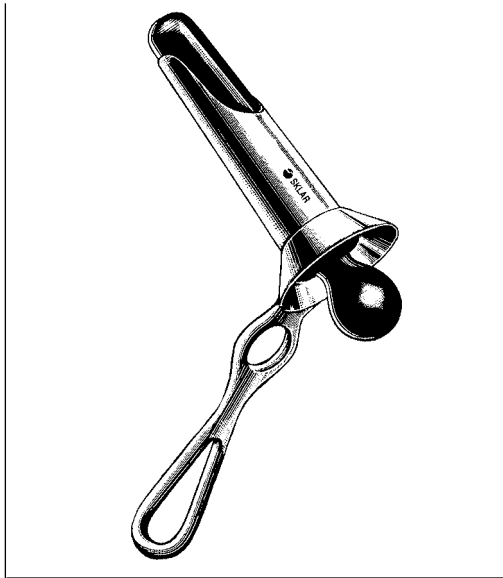


IVES RECTAL SPECULUM (FANSLER)

80-2245 3 1/4" Long
80-2244 Obturator only

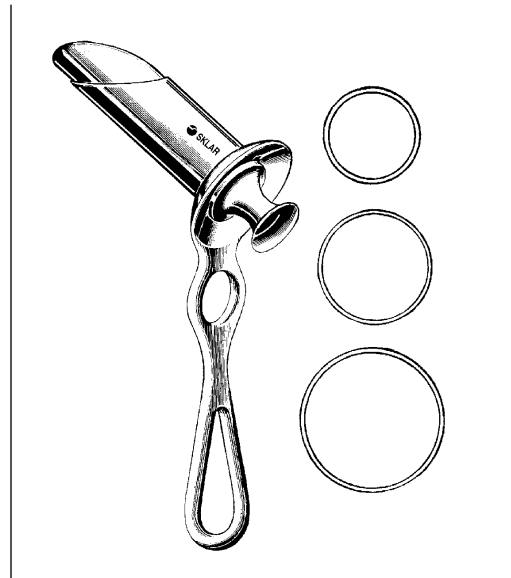
McGIVNEY HEMORRHOIDAL LIGATOR

- 80-1950 7" Complete With Loading Cone and 100 'O' Rings
- 80-1952 Loading Cone Only for McGivney
- 80-1951 Elastic 'O' Rings Package of 100



**IVES RECTAL SPECULUM
(FANSLER)**

80-2245 3 1/4" Long
80-2244 Obturator only

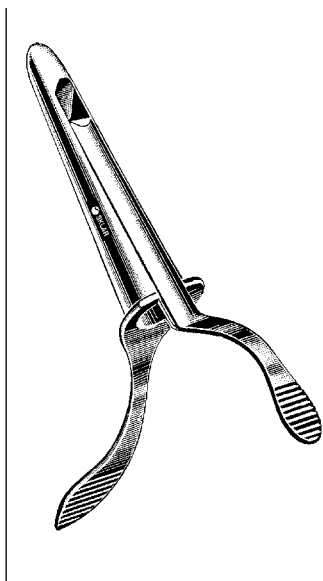


HIRSCHMAN ANOSCOPE

80-2688 1/16" Diameter Small 2 3/4"
80-2689 1 1/16" Diameter Med 2 3/4"
80-2690 7/8" Diameter Large 2 7/8"

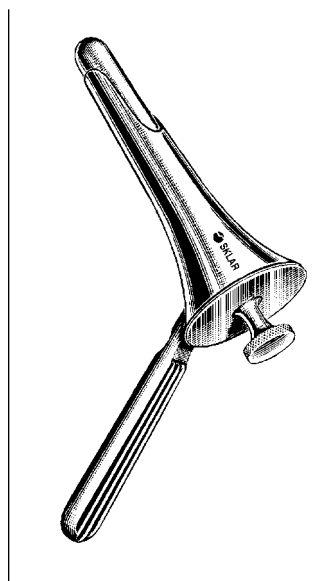
Proctoscope

80-2595 5" Long x 7/8"



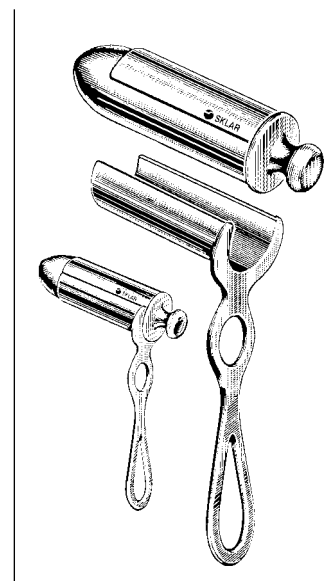
**BRINCKERHOFF
SPECULUM**

80-2142 Small
80-2143 Medium
80-2144 Large



HINKLE-JAMES SPECULUM

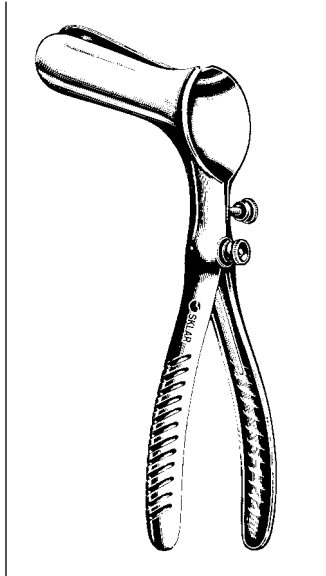
80-2271 5 1/8" Long
Tapered from 1 1/16" to 2 1/8"
80-2272 4 3/8" Long
Tapered from 5/8" to 2"



**CHELSEA EATON ANAL
SPECULUM**

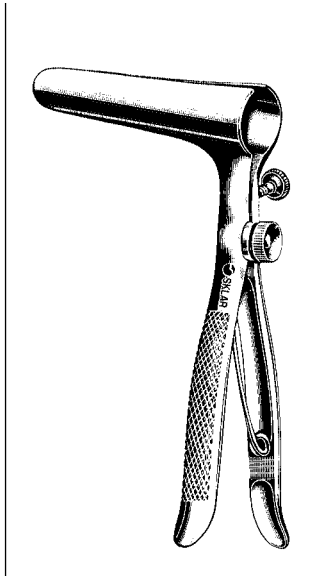
80-2260 Small
80-2261 Large

RECTAL INSTRUMENTS



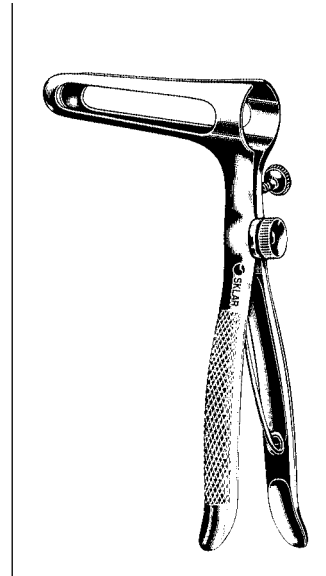
PRATT RECTAL SPECULUM

With Set Screw
80-2132



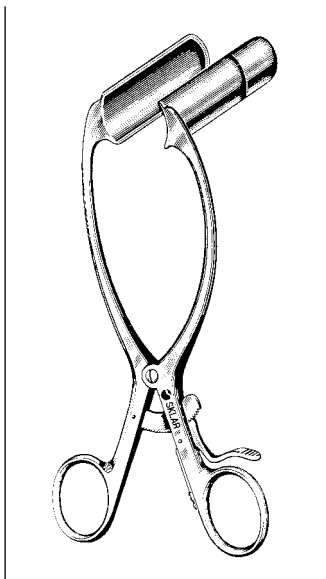
BODENHAMMER RECTAL SPECULUM

With Set Screw
80-2120 3½" Blades



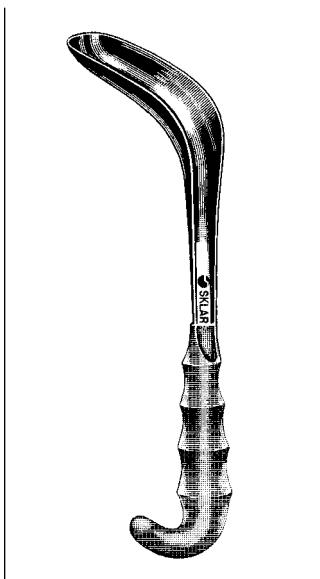
SIM RECTAL SPECULUM

With Set Screw
80-2125 Fenestrated Blades



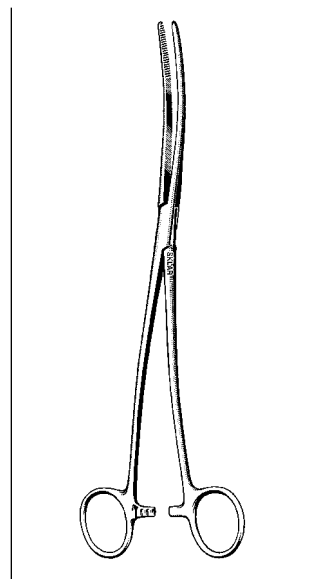
BARR RECTAL RETRACTOR

Tru-Grip Ratchet
80-2100 2¾" Blades



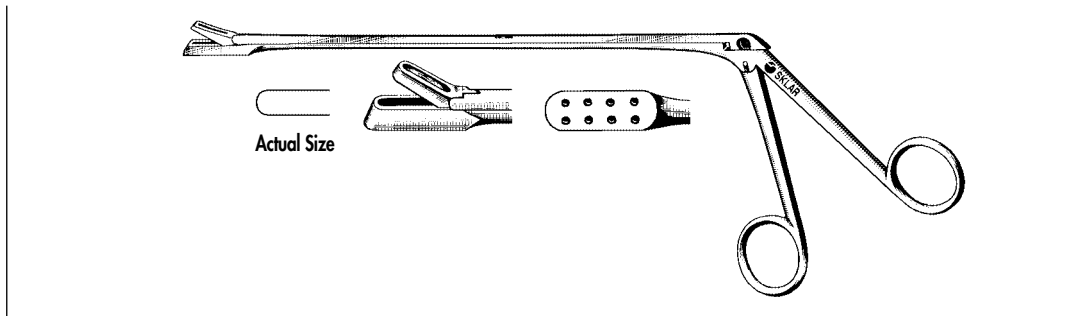
SAWYER RECTAL RETRACTOR

With Sklar Grip Handle
80-3922 2¼" x 7/8" Small
80-3927 2¾" x 1" Medium
80-3935 3½" x 1¼" Large



BOZEMAN DRESSING FORCEPS

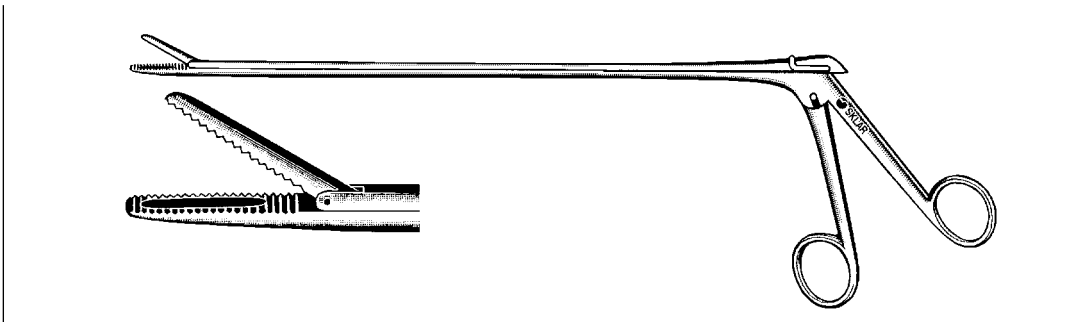
80-1410 10½" S-Curve
90-7610 10½" Straight
One large ring
90-7710 10½" S-Curve



YEOMAN SKLAR RECTAL BIOPSY PUNCH

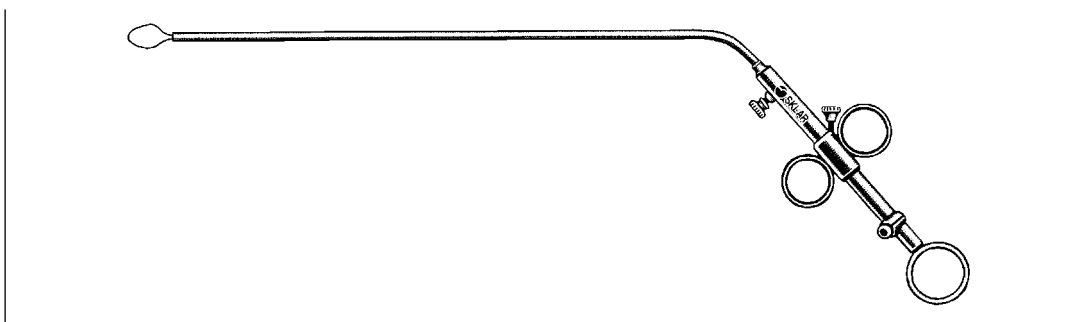
With Basket

80-1735 13³/₄" 80-1742 16¹/₂"



JACKSON ALLIGATOR GRASPING FORCEPS

79-3230 12" Serrated

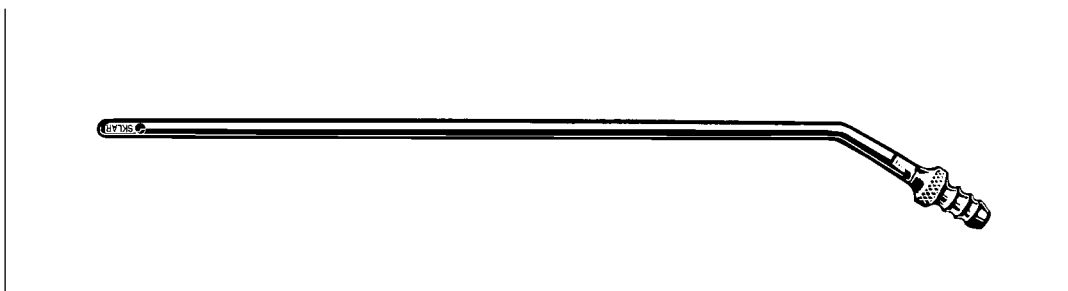


WESTON RECTAL SNARE

80-3812 12"

80-3814 Cut Snare Wires #5 (Package of 12)

80-3813 Stylet only for 80-3812

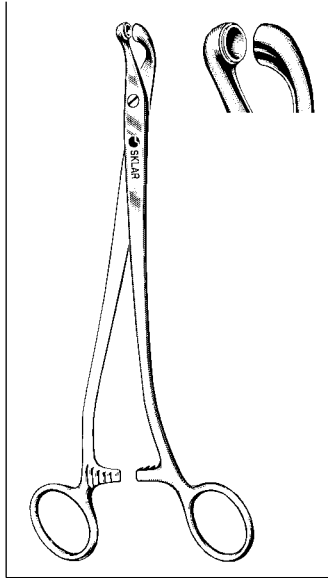


BUIE SUCTION TUBE

80-2815 15 French without Valve

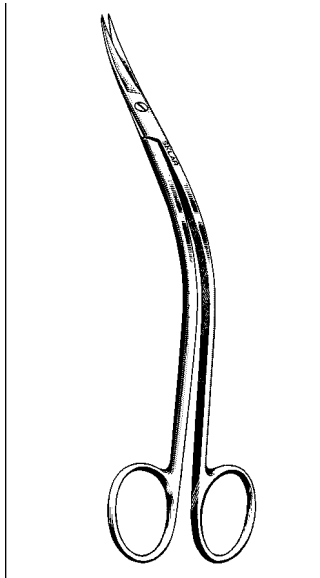
80-2715 15 French with Valve

RECTAL INSTRUMENTS



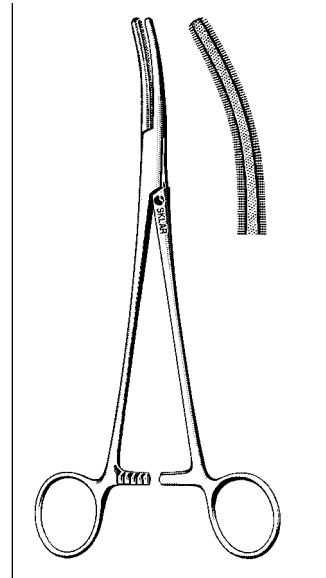
**THOMS-GAYLOR
BIOPSY FORCEPS**

Improved
80-1695 9½"



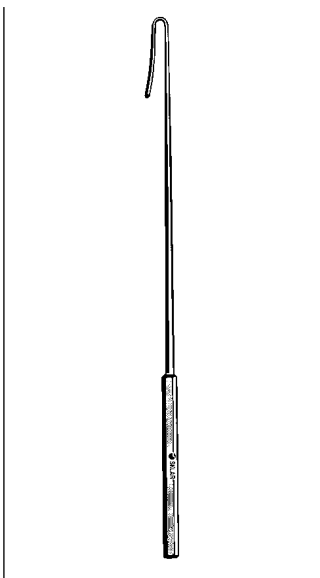
**MILLER RECTAL
SCISSORS**

Double Curve
80-1565 6½" Serrated



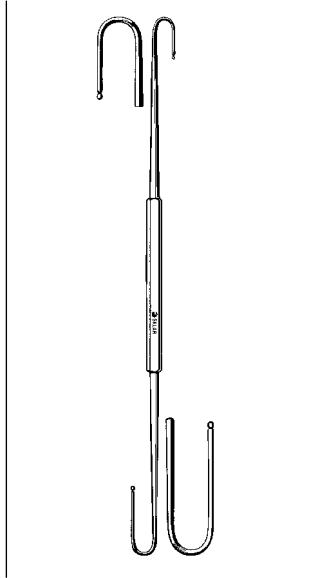
BUIE PILE CLAMP

80-1082 8½"



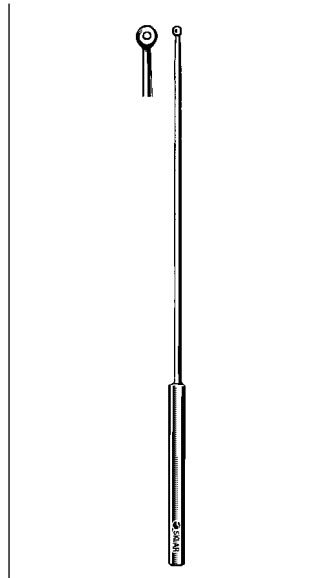
PRATT CRYPT HOOK

80-3185 8½"



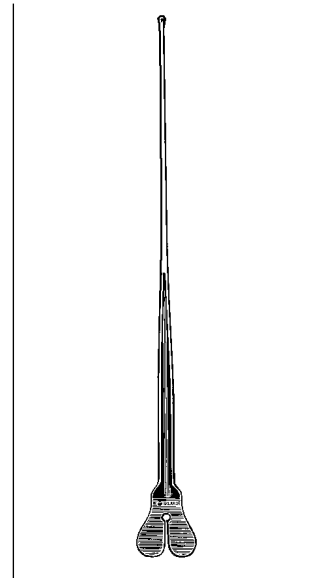
BARR CRYPT HOOK

Double End
80-3510 10½"



BARR FISTULA PROBE

With Eye
80-2910 10¾" Malleable



LARRY RECTAL PROBE

80-2870 7⅛"

MARLOW LASER BLACK ANAL SPECULUM

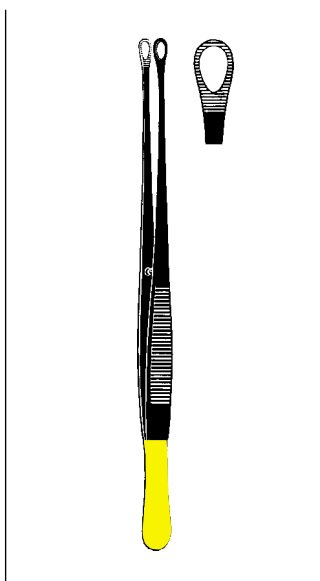
80-3990

The Marlow Anal Speculum features an opening that allows lesions to be isolated and lasered while the speculum is in place. Tissue compresses into the opening, and the plume is evacuated through a disposable tube in the handle base.

The Marlow speculum can be rotated a full 360° to view the entire anal canal and is also useful for hemorrhoidal examination.

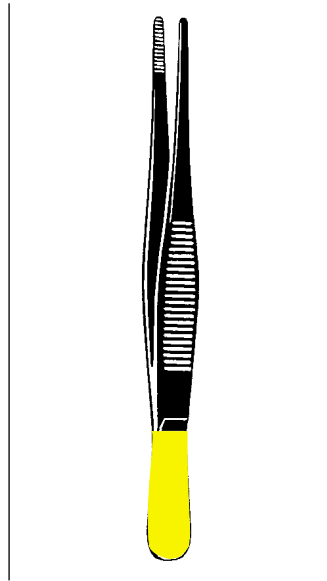
Also Available:

- 90-2270 Sklar Laser Black Surgery Forceps 7"
- 90-2276 Sklar Laser Black Allis Forceps 7½"
- 90-2278 Sklar Laser Black Babcock Forceps 8"
- 90-2306 Sklar Laser Black Dressing Forceps 8"



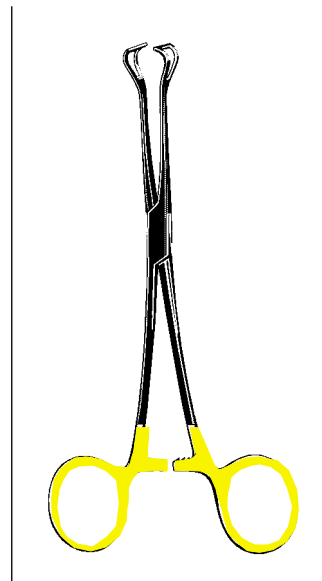
SKLAR LASER BLACK SURGERY FORCEPS

90-2270 7" Tuttle



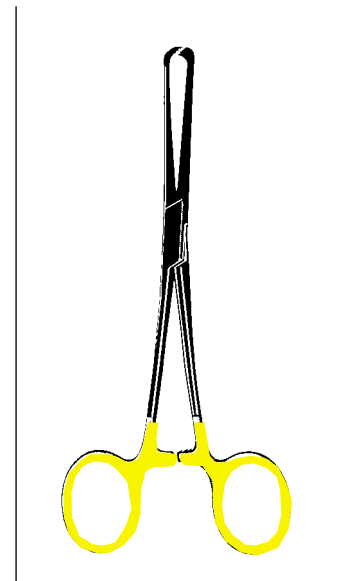
SKLAR LASER BLACK DRESSING FORCEPS

Potts-Smith
90-2306 10"



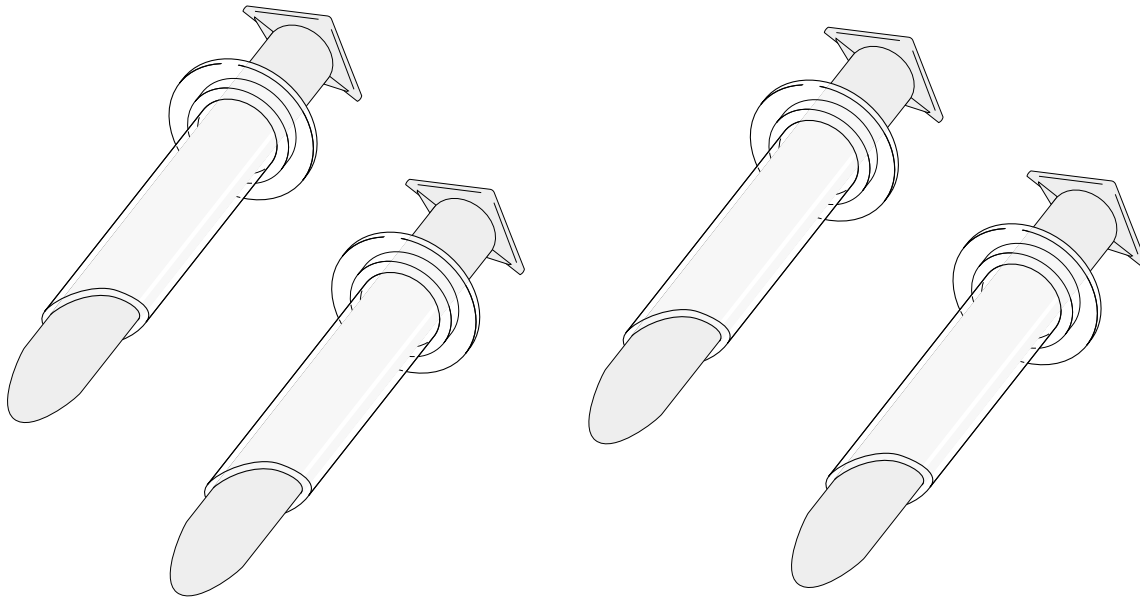
SKLAR LASER BLACK BABCOCK FORCEPS

90-2278 8"



SKLAR LASER BLACK ALLIS FORCEPS

90-2276 7½"



HIRSCHMAN TYPE PROCTOSCOPE

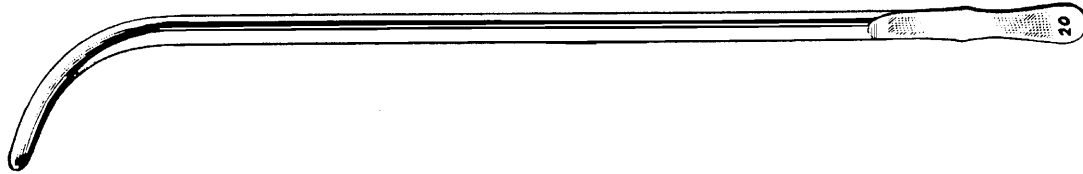
96-0910 Medium Pack of 25

The Sklar disposable proctoscope is convenient and easy to use. The transparent material offers a wider field of view during surgery or examination while eliminating the risk of cross infection.

Sklar Lifetime Warranty

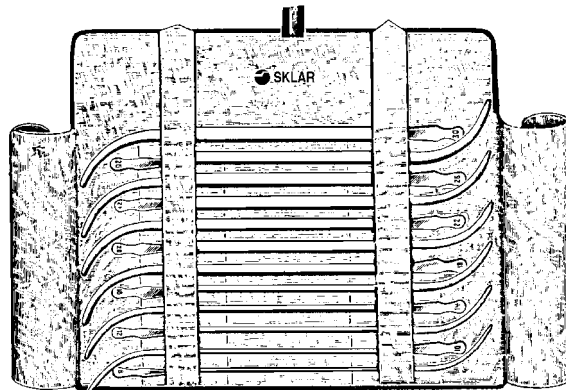
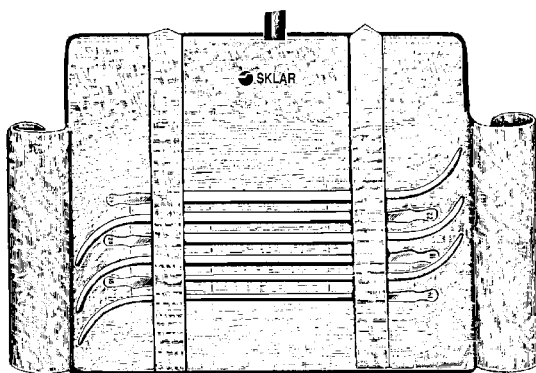
All Sklar Instruments are guaranteed for life against manufacturing defects provided the instrument is used for its intended surgical purpose.

Sklar will either repair or replace the instrument without charge at our discretion. Our guarantee is unqualified because Sklar instruments are checked by our own quality control inspectors.



VAN BUREN URETHRAL SOUND

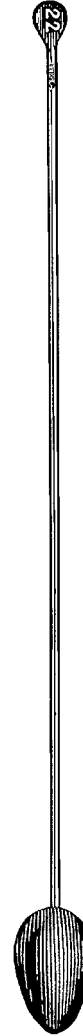
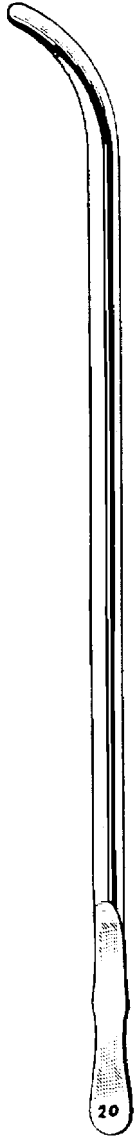
85-1008	8 Fr.	85-1018	18 Fr.	85-1028	28 Fr.	85-1038	38 Fr.
85-1010	10 Fr.	85-1020	20 Fr.	85-1030	30 Fr.	85-1040	40 Fr.
85-1012	12 Fr.	85-1022	22 Fr.	85-1032	32 Fr.	85-1065	Complete Set of all 17 sizes
85-1014	14 Fr.	85-1024	24 Fr.	85-1034	34 Fr.	85-1070	Set of 6 in Khaki Case, Sizes 14-16-18-20-22-24 French Diameter
85-1016	16 Fr.	85-1026	26 Fr.	85-1036	36 Fr.	85-1075	Set of 12 in Khaki Case, Sizes 8-10-12-14-16-18-20-22-24-26-28-30 French Diameter
						85-1076	Khaki Case Only



VAN BUREN URETHRAL SOUND

85-1065	Van Buren Sounds, Complete Set of 17
85-1070	Set of 6 in Khaki Case, Sizes 14-16-18-20-22-24 French Diameter
85-1075	Set of 12 in Khaki Case, Sizes 8-10-12-14-16-18-20-22-24-26-28-30 French Diameter
85-1076	Khaki Case Only

GENITO-URINARY INSTRUMENTS



OTIS/DITTEL URETHRAL SOUND

Short Curve

85-1408	8 Fr.	85-1426	26 Fr.
85-1410	10 Fr.	85-1428	28 Fr.
85-1412	12 Fr.	85-1430	30 Fr.
85-1414	14 Fr.	85-1432	32 Fr.
85-1416	16 Fr.	85-1434	34 Fr.
85-1418	18 Fr.	85-1436	36 Fr.
85-1420	20 Fr.	85-1438	38 Fr.
85-1422	22 Fr.	85-1440	40 Fr.
85-1424	24 Fr.		

85-1442	Set of 8 16-30 French
85-1446	Set of all 17 sizes

DITTEL URETHRAL SOUND

Straight-French Diameter

85-1308	No. 8	85-1326	No. 26
85-1310	No. 10	85-1328	No. 28
85-1312	No. 12	85-1330	No. 30
85-1314	No. 14	85-1332	No. 32
85-1316	No. 16	85-1334	No. 34
85-1318	No. 18	85-1336	No. 36
85-1320	No. 20	85-1338	No. 38
85-1322	No. 22	85-1340	No. 40
85-1324	No. 24		

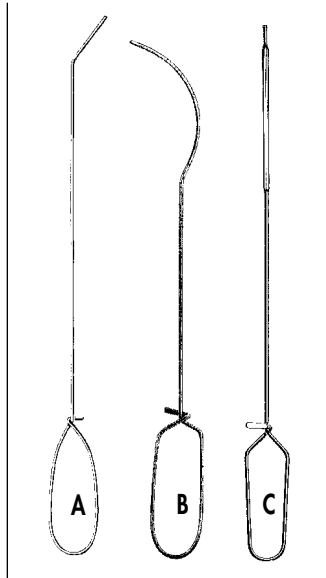
85-1342	Set of 6 in Khaki Case Sizes 8, 12, 16, 20, 24, 30
85-1345	Set of all 17 sizes in Khaki Case

OTIS BOUGIE A BOULE

Chrome

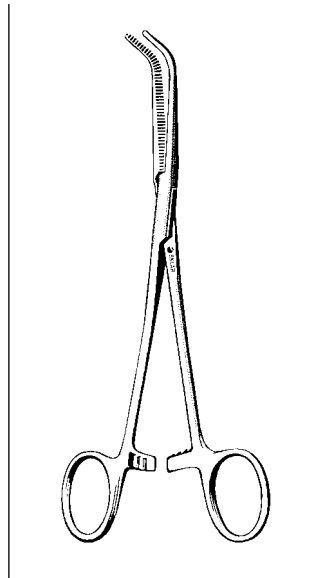
85-1608	8 Fr.	85-1622	22 Fr.
85-1610	10 Fr.	85-1624	24 Fr.
85-1612	12 Fr.	85-1626	26 Fr.
85-1614	14 Fr.	85-1628	28 Fr.
85-1616	16 Fr.	85-1630	30 Fr.
85-1618	18 Fr.	85-1632	32 Fr.
85-1620	20 Fr.		

85-1635	Set of 8 Sizes 16, 18, 20, 22, 24, 26, 28, 30
85-1636	Set of all 13 sizes



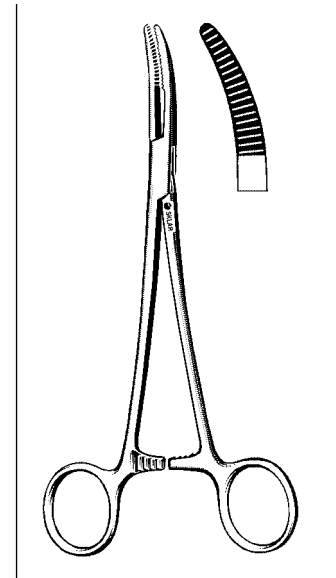
CATHETER GUIDES

- 85-2355 BENIQUE Catheter Guide Flexible 8 Fr. 'A'
- 85-2360 GUYON Catheter Guide Flexible 8 Fr. 'B'
- 85-2365 Catheter Guide, Straight Flexible 8 Fr. 'C'



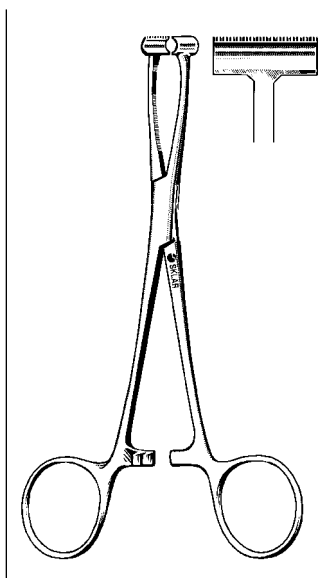
MIXER FORCEPS

- Right Angle
- 18-1250 5½" 55-2892 9¼" Heavy
 - 17-1762 6¼" 55-2894 10½" Longitudinal
 - 17-1772 7¼" 55-3012 12" Longitudinal Serrations Heavy



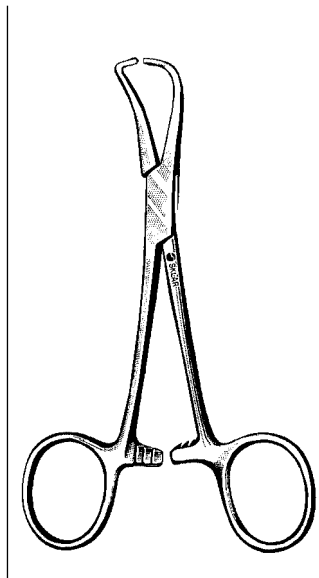
KELLY EXTRA HEAVY FORCEPS

- 74-3270 7" Curved



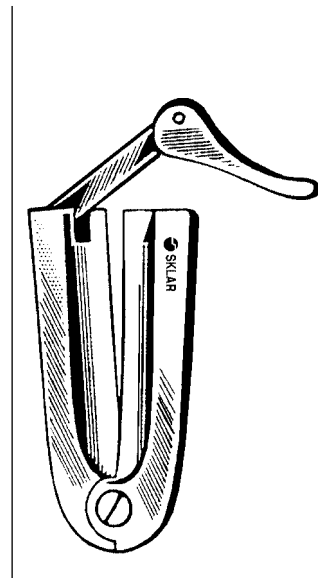
PRATT T SHAPED CLAMP

- 17-1055 6"



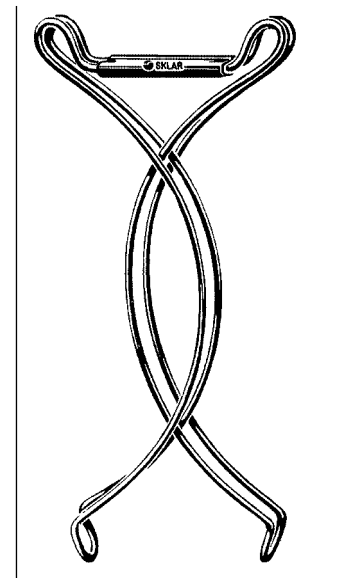
TEXTOR VASECTOMY CLAMP

- 85-6555 5½"



MOGEN CIRCUMCISION CLAMP

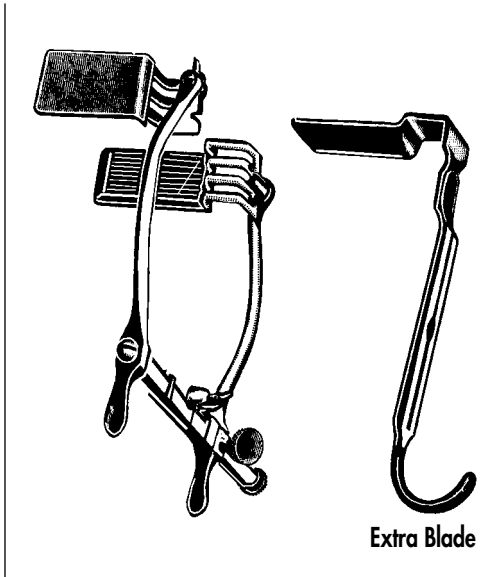
- 85-6550
- 85-6551 Circumcision Probe



STOCKMAN (ZIPSER) PENIS CLAMP

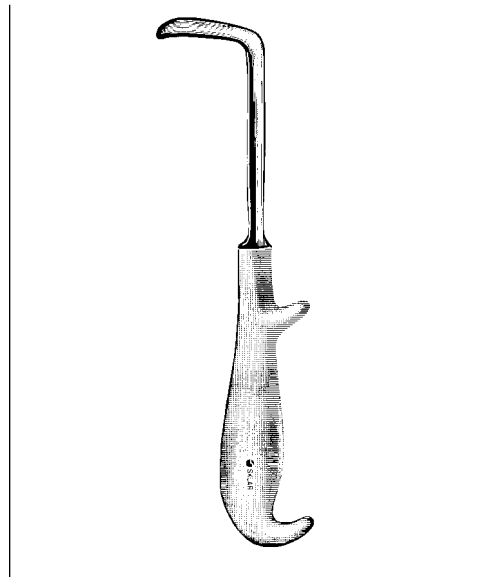
- 85-6450

GENITO-URINARY INSTRUMENTS



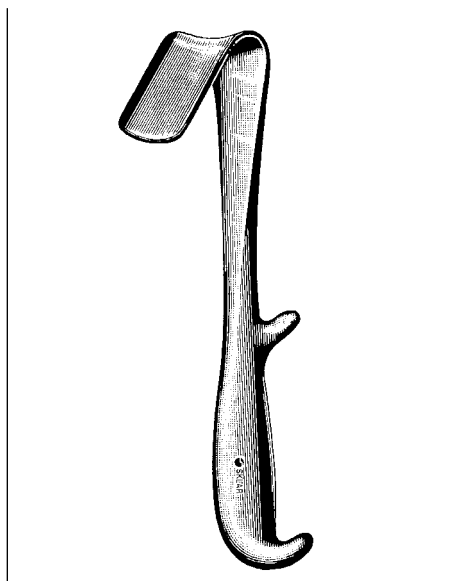
JUDD-MASSON BLADDER AND SUPRAPUBIC RETRACTOR

85-5350 With 2 blades
85-5346 Extra blade only



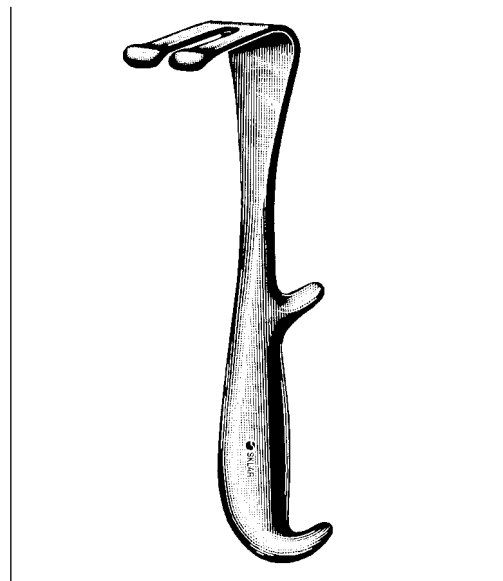
YOUNG PROSTATIC RETRACTOR

85-4697 8½" Lateral



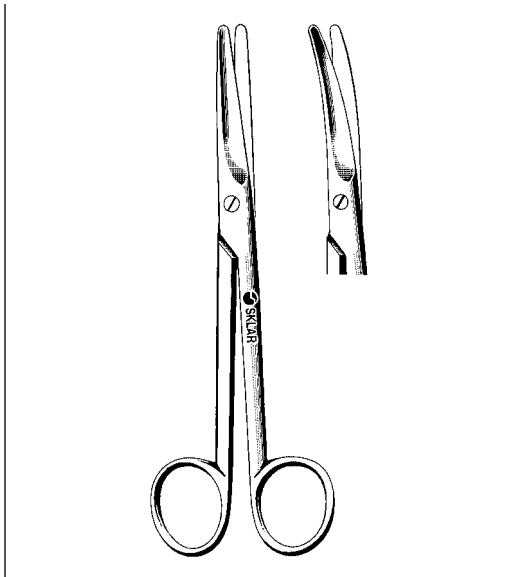
YOUNG RETRACTOR

85-4780 8" Anterior



YOUNG RETRACTOR

Bifurcated
85-4970 8½"



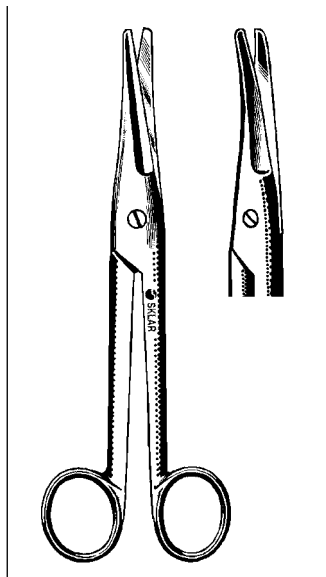
MAYO DISSECTING SCISSORS

Straight		Curved	
15-1555	5½"	15-2555	5½"
15-1567	6¾"	15-2567	6¾"
90-1590	9"	90-1690	9"



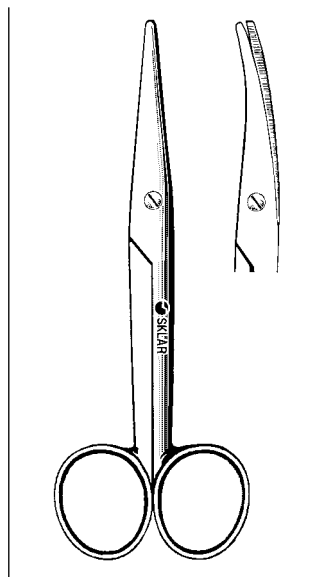
SKLARLITE MAYO DISSECTING SCISSORS

Straight		Curved	
23-1164	5½"	23-1166	5½"
23-1165	6¾"	23-1167	6¾"



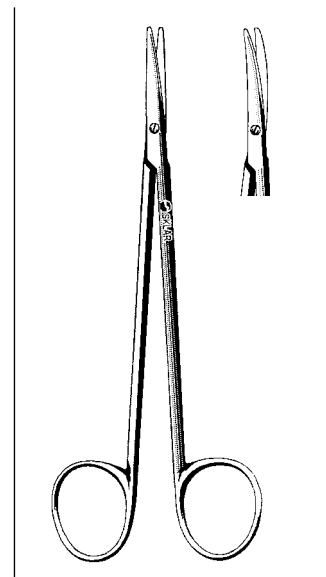
MAYO-NOBLE DISSECTING SCISSORS

Straight		Curved	
15-1762	6½"	15-2762	6½"



MAYO-STILLE DISSECTING SCISSORS ROUNDED BLADES

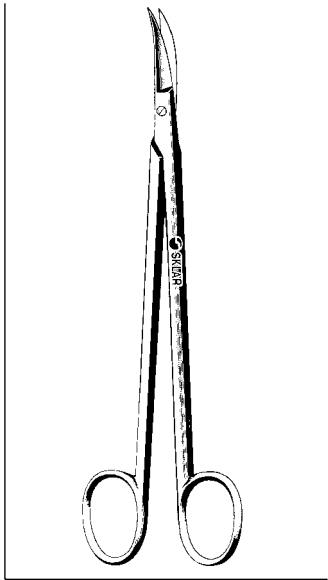
Straight		Curved	
15-1655	5½"	15-2655	5½"
15-1667	6¾"	15-2667	6¾"



METZENBAUM (NELSON) SCISSORS

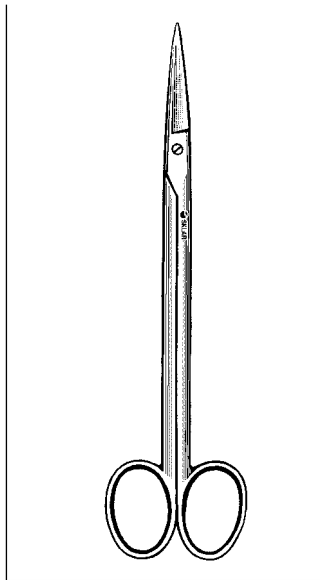
Straight		Curved	
55-9310	10"	55-9210	10"
55-9311	11"	55-9411	11"
		55-9612	12"

GENITO-URINARY INSTRUMENTS



KELLY SCISSORS CURVED

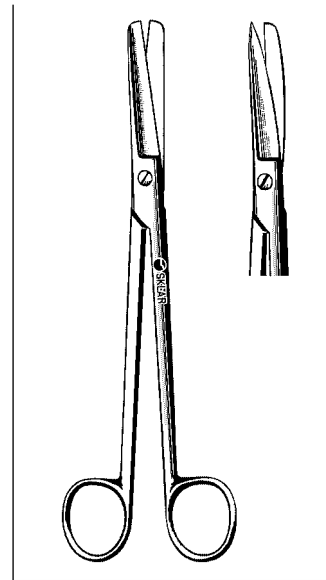
50-4662 6¼" Smooth



KELLY-ADSON SCISSORS

Straight

50-4562 6¼" Smooth
50-4563 6¼" Serrated



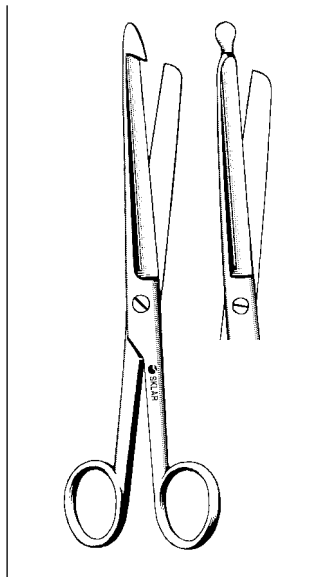
SIMS SCISSORS

Straight

90-1280 8" S/S
90-1180 8" S/B
90-1080 8" B/B

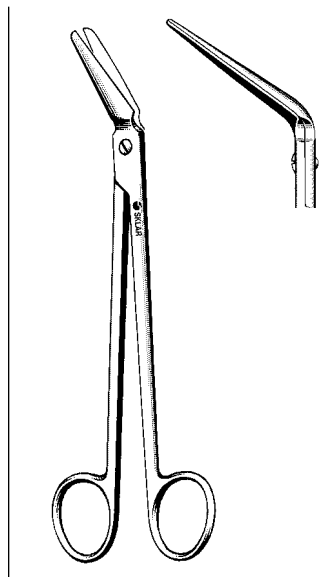
Curved

90-1580 8" S/S
90-1480 8" S/B
90-1380 8" B/B



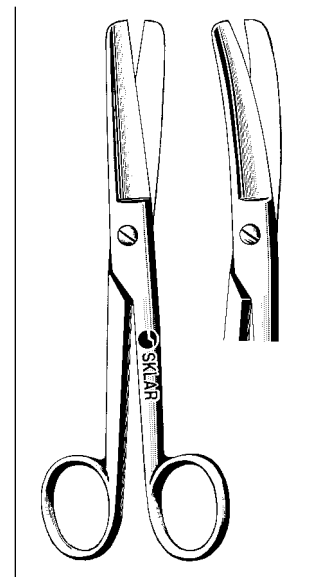
ENTEROTOME SCISSORS

15-1282 8¼" Hook Point
15-1285 8¼" Probe Point



SWEET SCISSORS 45° ANGLE

55-8380 8"



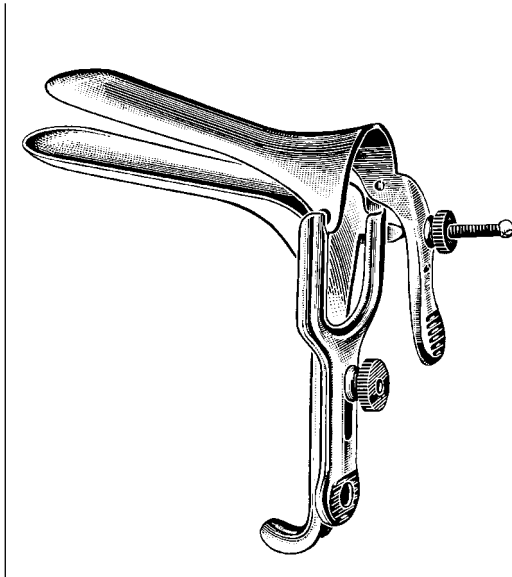
DOYEN SCISSORS

Straight

15-1307 7"
15-1308 7" Serrated

Curved

15-2307 7"
15-2308 7" Serrated



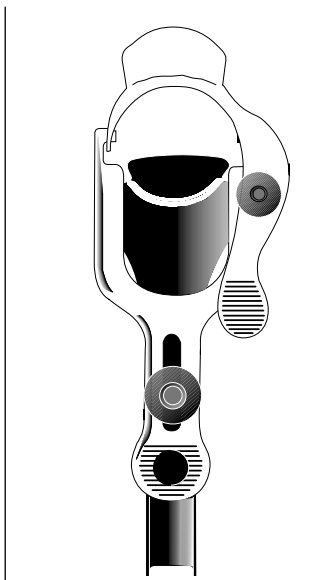
GRAVES VAGINAL SPECULUM

90-3700 3" x 3/4" Small
 90-3701 4" x 1 1/4" Medium
 90-3702 4 1/2" x 1 3/8" Large



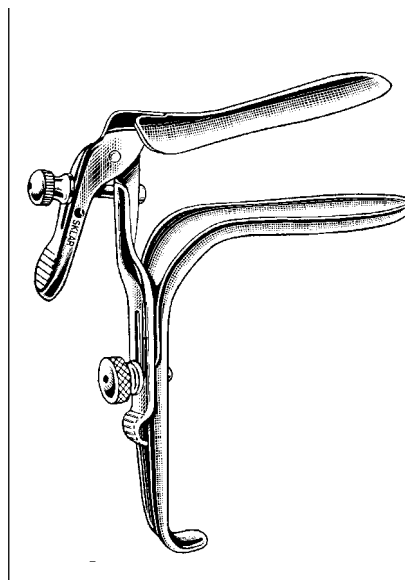
GRAVES VAGINAL SPECULUM

90-3800 3" x 1/2" Extra Small
 90-3802 4 3/4" x 1 1/2" Extra Large



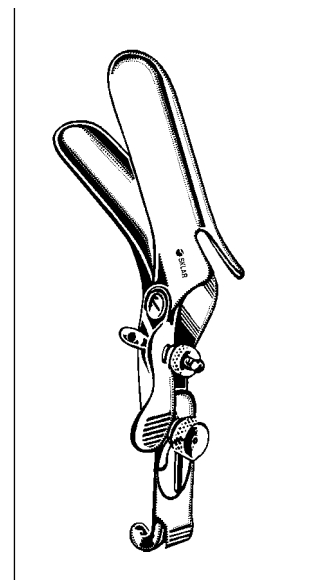
GRAVES VAGINAL SPECULUM WIDE VIEW PATTERN

Wide proximal opening for instrumentation
 90-3705 Wide View



FREEWAY GRAVES VAGINAL SPECULUM

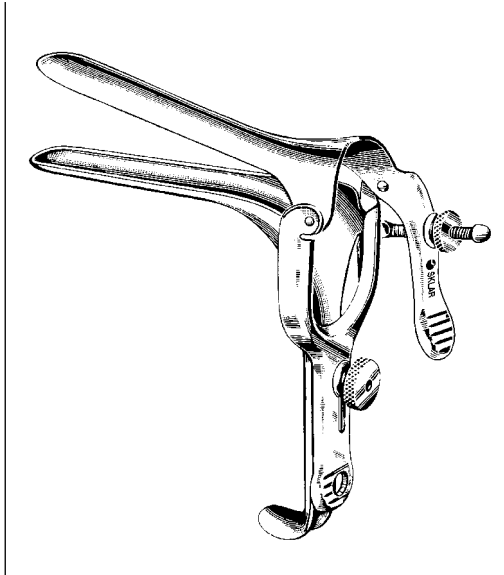
Open Side
 90-3750 4" x 1 1/4" 90° Angle



FREEWAY GRAVES VAGINAL SPECULUM

Open Side
 90-3752 45° Angle

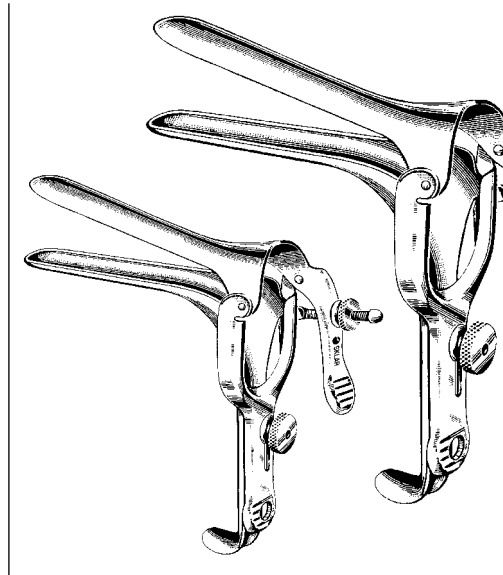
GYNECOLOGICAL INSTRUMENTS



PEDERSON VAGINAL SPECULUM

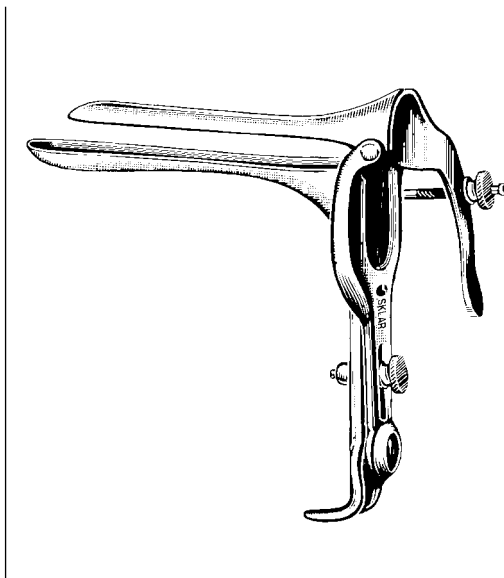
Narrow Blades

- 90-3710 3" x 1/2" Small
- 90-3711 4 3/4" x 1" Large
- 90-3713 4" x 7/8" Medium



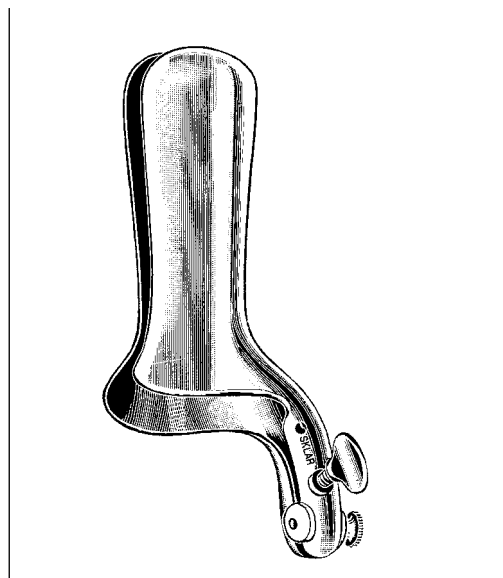
PEDERSON VAGINAL SPECULUM

- 90-3849 Extra Small
- 90-3851 Extra Large



PEDERSON VAGINAL SPECULUM

- 90-3712 4" x 5/8" Slender



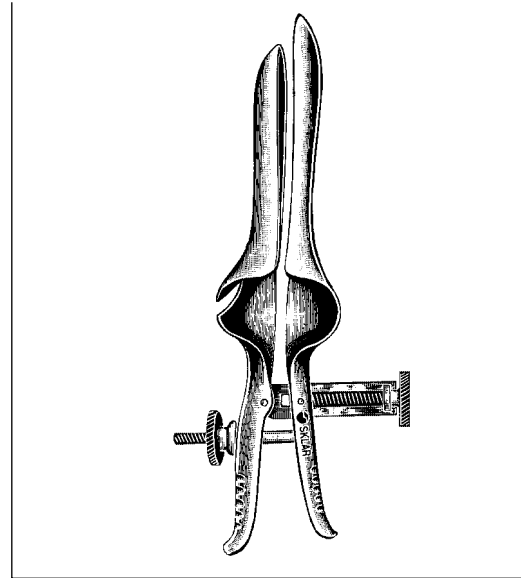
COLLIN VAGINAL SPECULUM

- 90-3945 4 1/4" x 1 1/4" Blades



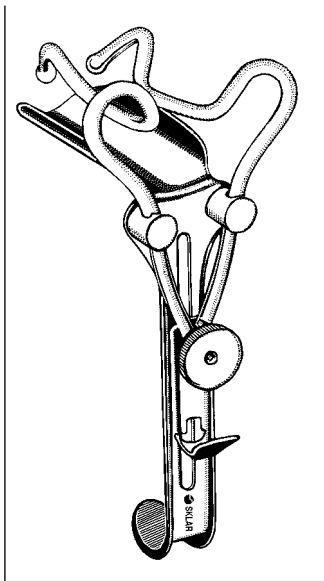
CUSCO VAGINAL SPECULUM

90-3957 3" x 1¼" Small
 90-3959 3½" x 1½" Medium
 90-3960 3¾" x 1¾" Large



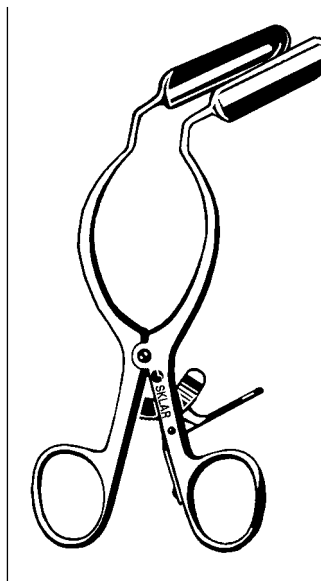
DE VILBISS VAGINAL SPECULUM

(Miller)
 90-3865 4 x 1¼" Blades Parallel Opening, Chrome Plated



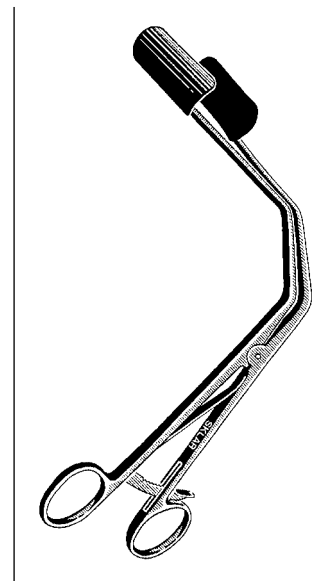
GUTMANN VAGINAL SPECULUM

Examining Type
 90-3954 1¾" x 4" Self Retaining



McGEE LATERAL VAGINAL RETRACTOR

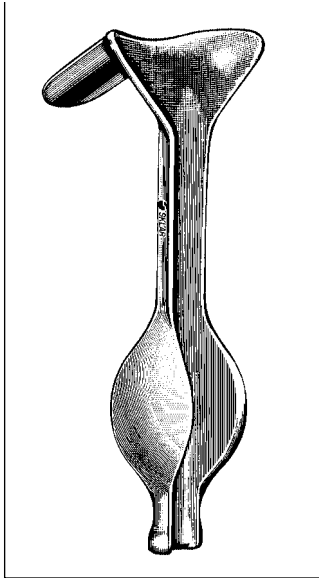
Ratchet Handle
 90-3695 Fits inside Vaginal Speculum



SKLAR LATERAL VAGINAL RETRACTOR

Ratchet Handle
 90-3698 Fits inside Vaginal Speculum

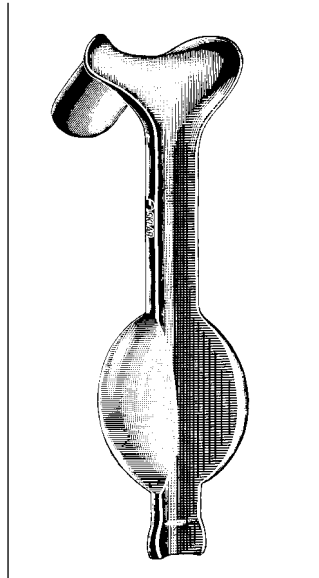
GYNECOLOGICAL INSTRUMENTS



AUWARD WEIGHTED VAGINAL SPECULUM

Blades $2\frac{3}{4}'' \times 1\frac{1}{2}''$

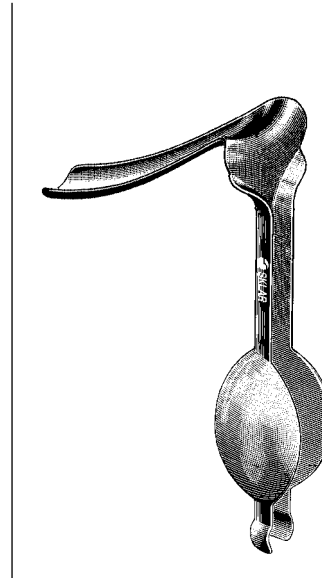
- 90-3525 Light 2 lbs.
- 90-3526 Medium $2\frac{1}{2}$ lbs.
- 90-3527 Heavy 3 lbs.
- Extra Long Blades $4'' \times 1\frac{3}{4}''$
- 90-3530 Medium $2\frac{1}{2}$ lbs.



GARRIGUE WEIGHTED VAGINAL SPECULUM

Blades $3'' \times 1\frac{1}{2}''$

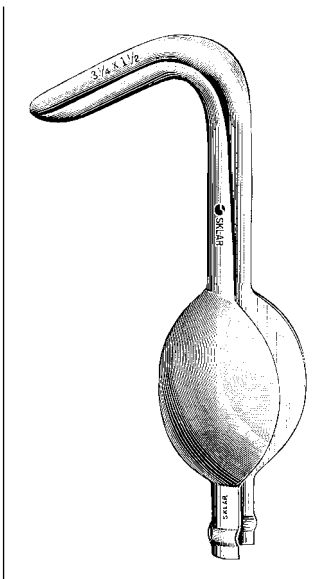
- 90-3535 Light 2 lbs.
- 90-3536 Medium $2\frac{1}{2}$ lbs.
- 90-3537 Heavy 3 lbs.



STEINER-AUWARD WEIGHTED VAGINAL SPECULUM

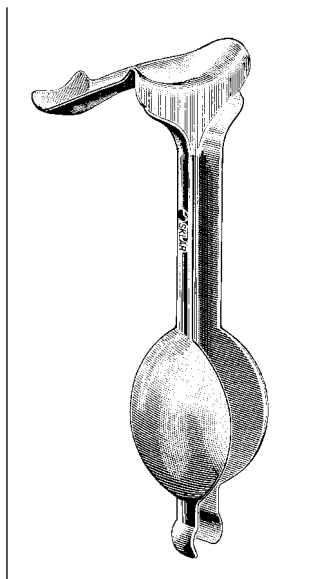
Blades $5\frac{1}{2}'' \times 1\frac{1}{4}''$

- 90-3559 $2\frac{1}{2}$ lbs.
- Laser Pattern
- 90-3560 $2\frac{1}{2}$ lbs. $5\frac{1}{2}'' \times 1\frac{1}{4}''$



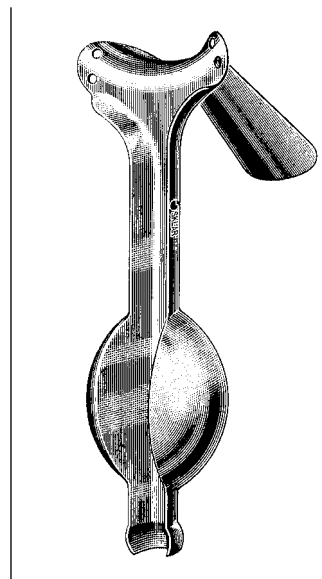
HENROTIN WEIGHTED VAGINAL SPECULUM

- 90-3555 3 lbs. $3\frac{1}{4}'' \times 1\frac{1}{4}''$
30° Blade Angled Down



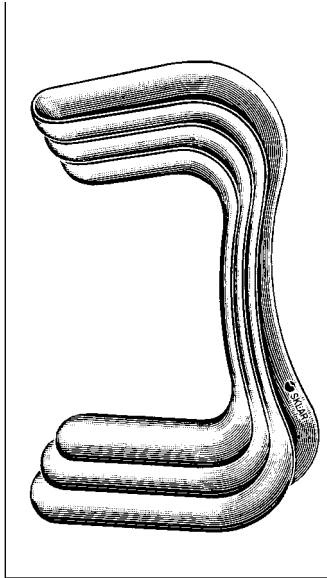
STEINER-SKLAR WEIGHTED VAGINAL SPECULUM

- Chrome with Vertical Lip
- 90-3552 3 lbs. $3\frac{1}{4}'' \times 1\frac{3}{4}''$



BERLIND-AUWARD WEIGHTED VAGINAL SPECULUM

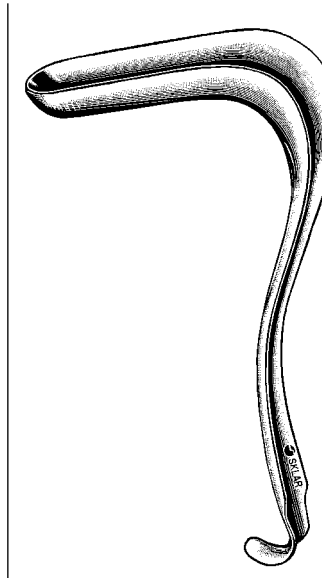
- 90-3558 $2\frac{1}{2}$ lbs. $4\frac{1}{4}'' \times 1\frac{5}{8}''$



SIMS VAGINAL RETRACTOR

Double End

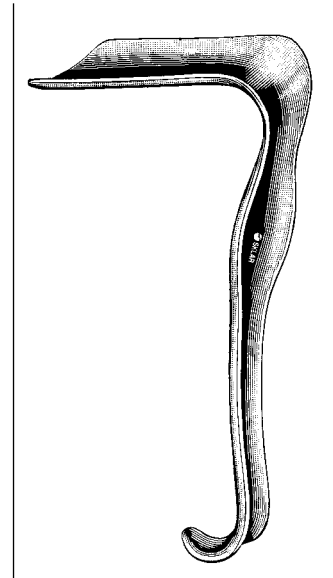
90-3152	1" x 3" and 1 1/4" x 3 1/4"	#3
90-3153	1 1/4" x 3" and 1 1/2" x 3 1/4"	#4
90-3154	1 1/4" x 3 1/4" and 1 1/2" x 4"	#5



SIMS VAGINAL RETRACTOR

Single End

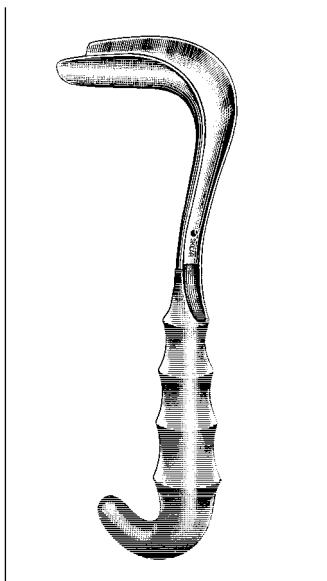
90-3230	3" x 1 1/4"	Medium
---------	-------------	--------



JACKSON VAGINAL RETRACTOR

Single End

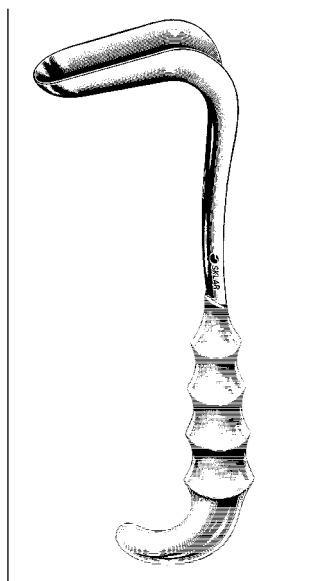
90-3130	3" x 1 1/2"	Small
90-3135	3 1/2" x 1 1/2"	Medium
90-3140	4" x 1 1/2"	Large



SIMS-KELLY VAGINAL RETRACTOR

Sklar-Grip Handle

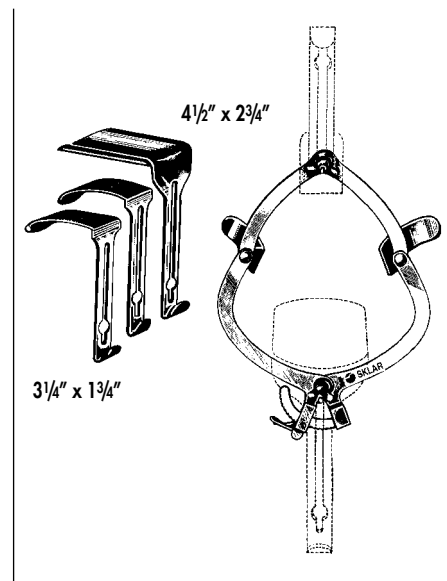
90-3422	2 1/4" x 1"	Small
90-3430	3" x 1 1/2"	Large



SIMS VAGINAL RETRACTOR

Sklar-Grip Handle

90-3327	2 3/4" x 1"	Small
90-3330	3" x 1 1/4"	Medium
90-3335	3 1/2" x 1 1/2"	Large

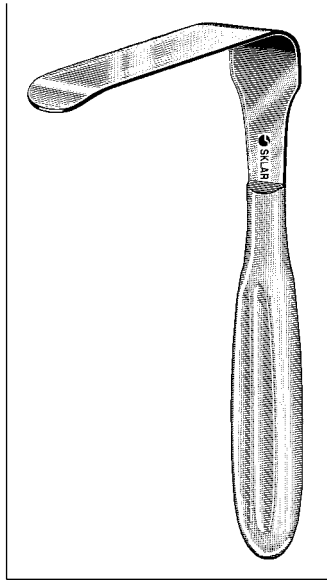


O'SULLIVAN O'CONNER RETRACTOR

With 3 Interchangeable Blades

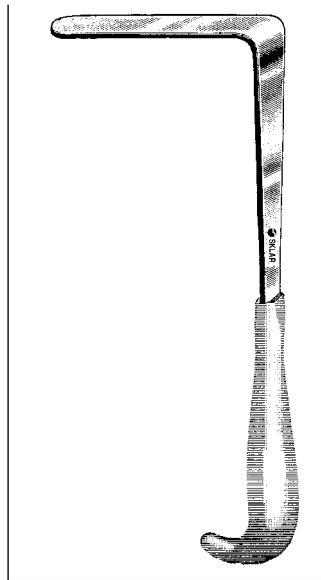
90-3025	2 Large 1 Small
---------	-----------------

GYNECOLOGICAL INSTRUMENTS



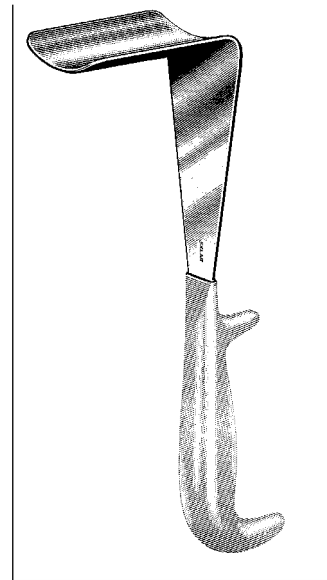
**BRANTLEY-TURNER
VAGINAL RETRACTOR**

90-3470 7" 4" x 1¼" Blade



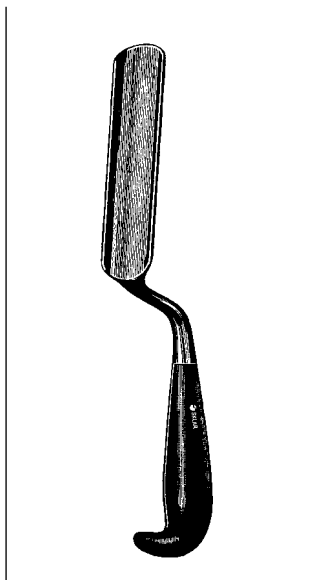
**PRYER-PEAN VAGINAL
RETRACTOR**

90-3510 10¼" 4¼" x 1" Blade



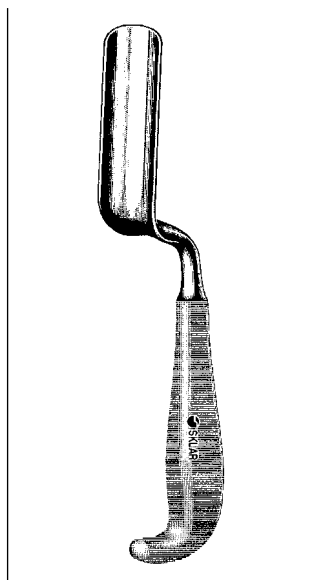
DOYEN RETRACTOR

60-2185 1¾" x 2½" 8½"
60-2190 2½" x 3" 8½"
60-2195 2¼" x 3½" 8½"



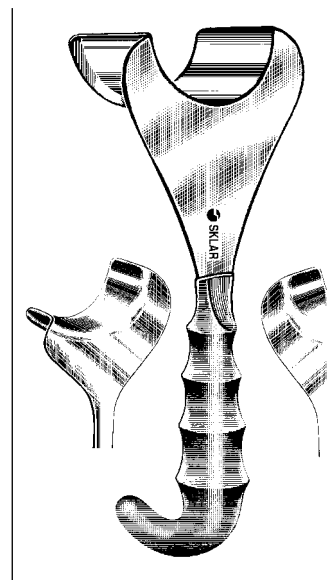
**SEGOND VAGINAL
SPATULA**

90-3610 4¾" x 1⅜"



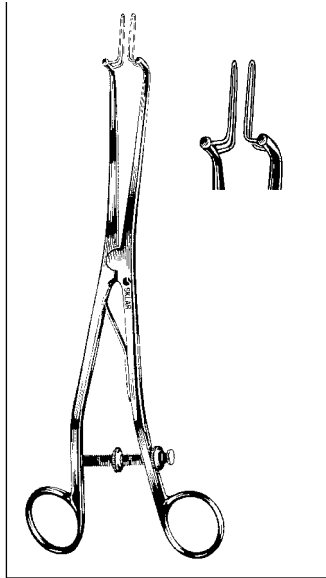
**TAUBER VAGINAL
SPATULA**

90-3692 3½" x 1⅜"



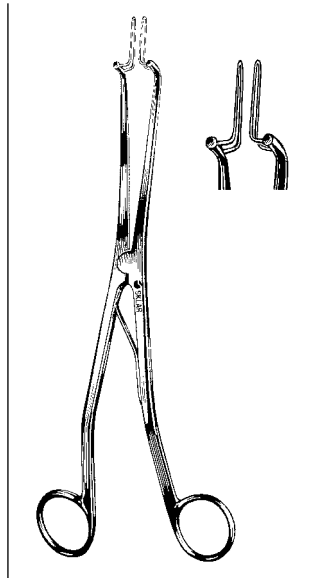
DELEE RETRACTOR

Right
90-3450 2¾" x 2"
Left
90-3451 2¾" x 2"
Universal
90-3452 2¾" x 2"



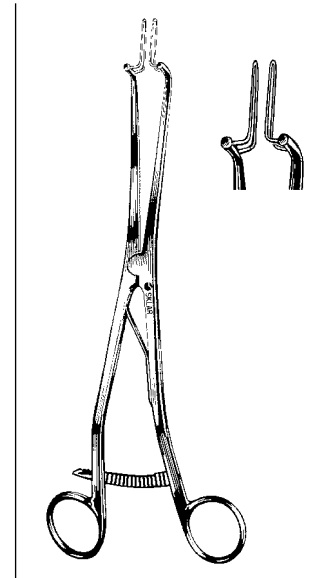
**KOGEN ENDOCERVICAL
SPECULUM**

With Gauge and Screws
90-3990 Narrow Wire Blades



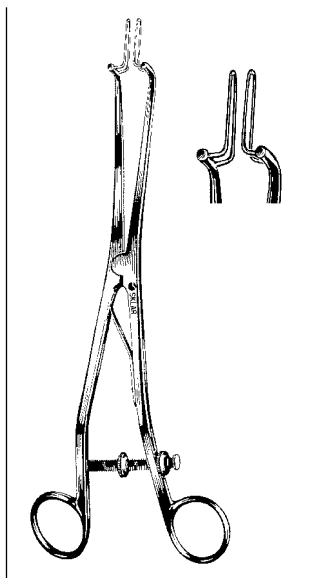
**KOGEN ENDOCERVICAL
SPECULUM**

With Spring
90-3996 Narrow Wire Blades



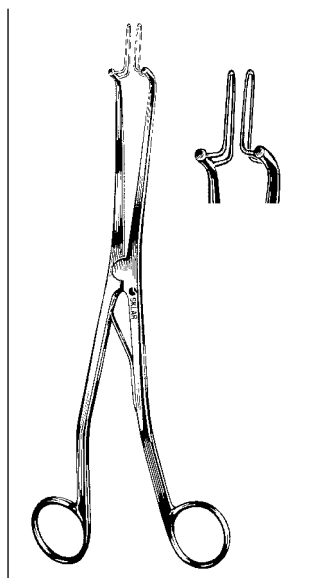
**KOGEN ENDOCERVICAL
SPECULUM**

With Ratchet
90-3997 Narrow Wire Blades



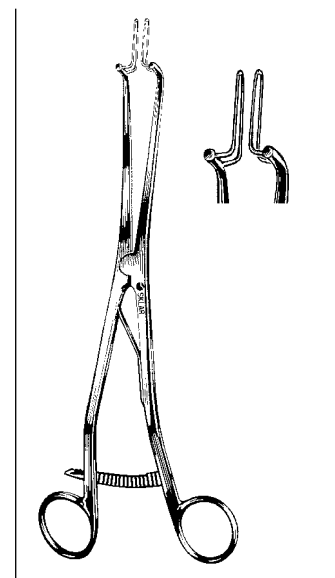
**KOGEN ENDOCERVICAL
SPECULUM**

With Gauge and Screws
90-3995 Wide Wire Blades



**KOGEN ENDOCERVICAL
SPECULUM**

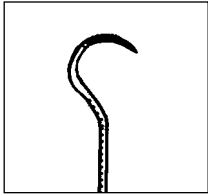
With Spring
90-3994 Wide Wire Blades



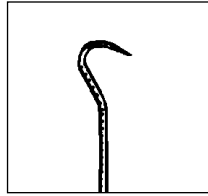
**KOGEN ENDOCERVICAL
SPECULUM**

With Ratchet
90-3998 Wide Wire Blades

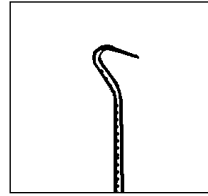
GYNECOLOGICAL INSTRUMENTS



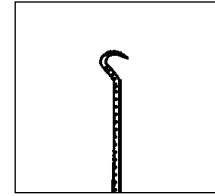
Emmett:
6mm Diameter



Mini Emmett:
4mm Diameter



Maxi Iris:
3mm Diameter



Iris:
1mm Diameter



QUICK RELEASE EMMETT HOOK

- 90-8333 9" #1
- 90-8342 12" #1
- 90-8332 Quick Release Tissue Hooks
9" Set of 4
- 90-8341 Quick Release Tissue Hooks
12" Set of 4

QUICK RELEASE MINI EMMETT HOOK

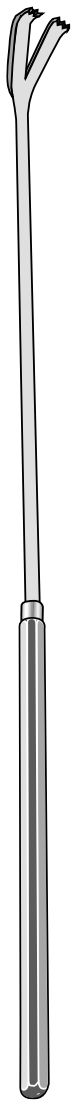
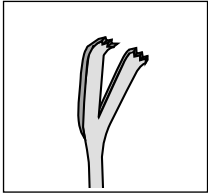
- 90-8334 9" #2
- 90-8344 12" #2

QUICK RELEASE MAXI IRIS HOOK

- 90-8335 9" #3
- 90-8346 12" #3

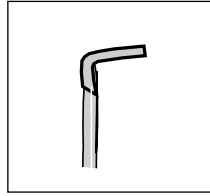
QUICK RELEASE IRIS HOOK

- 90-8336 9" #4
- 90-8348 12" #4



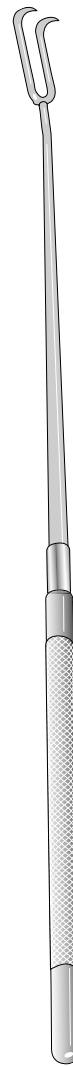
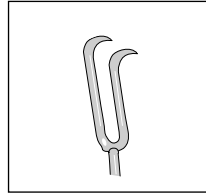
**NEWPORT CERVICAL
MANIPULATOR**

90-8355



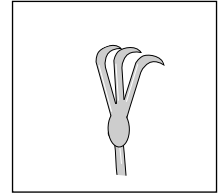
OFFSET HOOK

For Positioning Tissue
90-8362 $\frac{3}{8}$ " 85° Angle



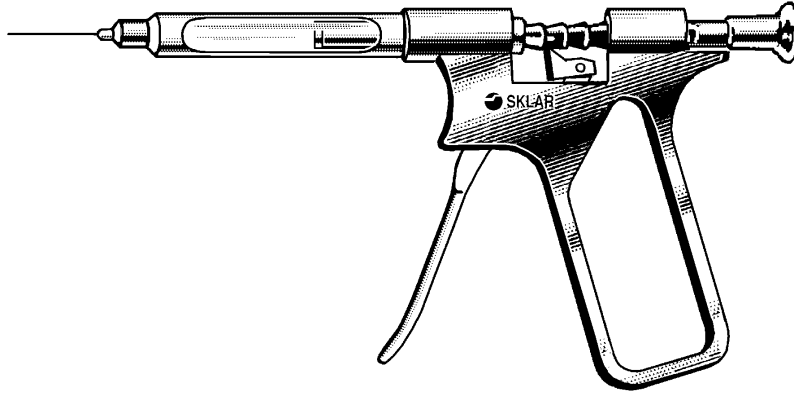
**CAMPION CERVICAL
HOOK**

Two Sharp Prongs
90-8360 20° Angle



CERVICAL HOOK

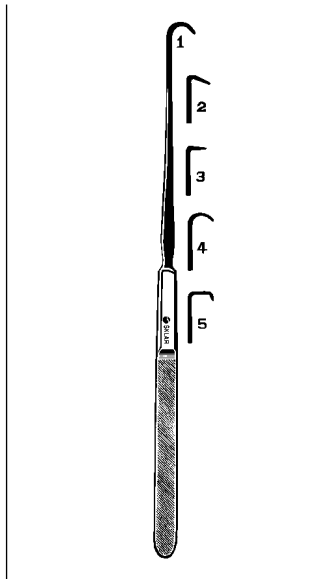
Three Sharp Prongs
90-8361



SKLAR MEASURED DOSE DELIVERY SYRINGE

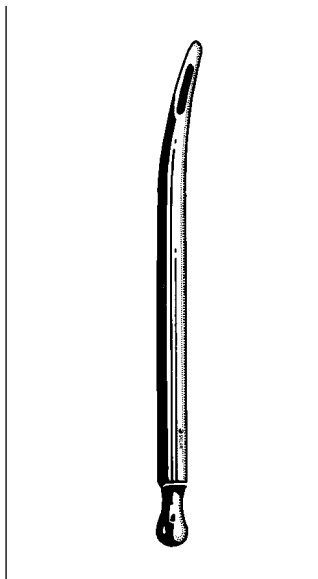
90-8720 Syringe Measured Dose
2cc Carpule

- The most effective delivery system on the market for cervical anesthesia and paracervical blocks.
- Measured dosage delivery system, each squeeze of the trigger delivers precisely 0.2cc of anesthesia.
 - Uses 2cc carpule
 - High injection pressure
 - Design keeps hand conveniently out of your field of view
 - Design also provides stabilization of barrel and needle
 - Overall length adjustable from 5 $\frac{3}{4}$ " to 9 $\frac{1}{4}$ "



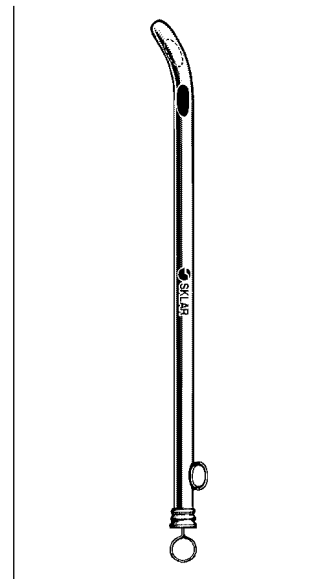
EMMETT HOOK 9"

90-8301 Style 1
90-8302 Style 2
90-8303 Style 3
90-8304 Style 4
90-8305 Style 5
90-8306 Set of 5



WALTHER DILATOR-CATHETERS 5 $\frac{1}{4}$ "

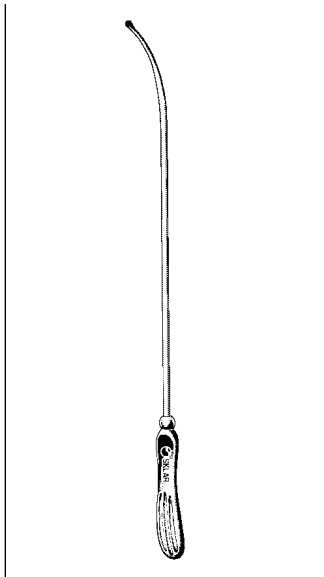
85-2010	Set of 14	85-2026	26 Fr.
85-2012	12 Fr.	85-2028	28 Fr.
85-2014	14 Fr.	85-2030	30 Fr.
85-2016	16 Fr.	85-2032	32 Fr.
85-2018	18 Fr.	85-2034	34 Fr.
85-2020	20 Fr.	85-2036	36 Fr.
85-2022	22 Fr.	85-2038	38 Fr.
85-2024	24 Fr.		



FEMALE CATHETERS

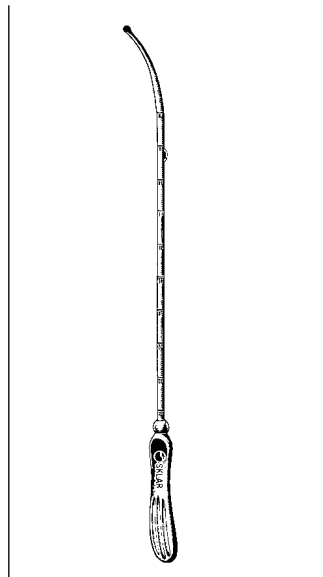
Chrome

85-2210	10 Fr.
85-2212	12 Fr.
85-2214	14 Fr.
85-2216	16 Fr.
85-2218	18 Fr.
85-2220	20 Fr.



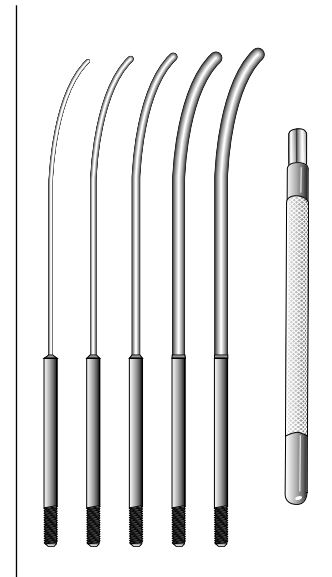
SIMS UTERINE SOUND

Non-Graduated - Silver Plated
90-5312 12½"



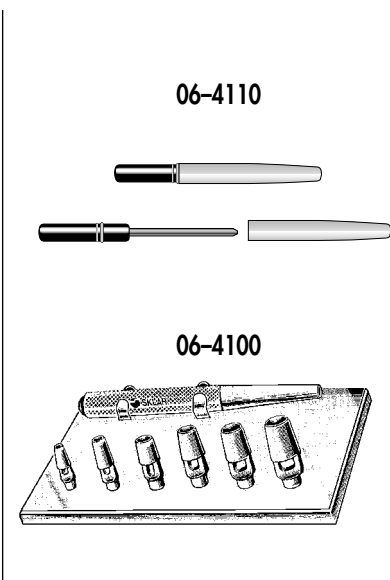
SIMPSON UTERINE SOUND MALLEABLE

Graduated - Silver Plated
90-5412 12½" Inch Markings
90-5413 12½" Cm Markings



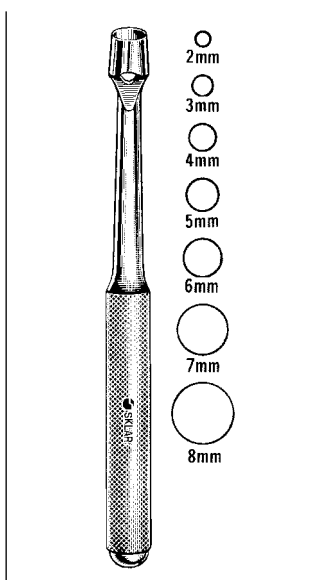
SKLAR MINI-DILATOR/ OS FINDER SET

Small Size Dilator Uterine
90-6280 From 1mm to 3mm in .5mm increments. All five dilators interchange on a universal handle.



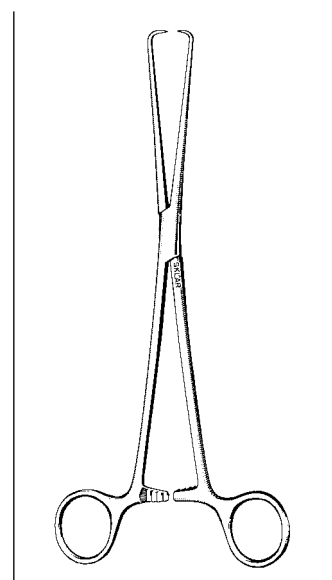
KEYES VULVAR/DERMAL PUNCH

06-4100 6 Punches interchangeable on Universal Handle 2mm thru 7mm with sterilizable base.
06-4110 Keyes Punch Sharpener to maintain a keen edge on all Keyes Punches.



KEYES BIOPSY PUNCH

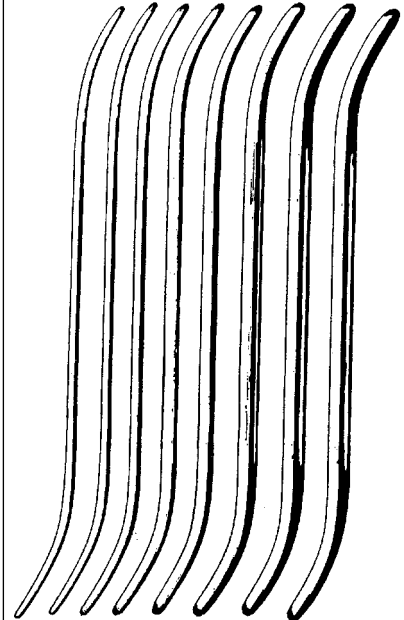
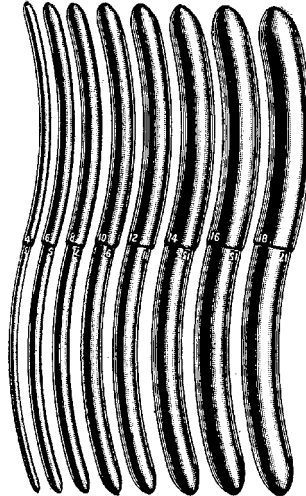
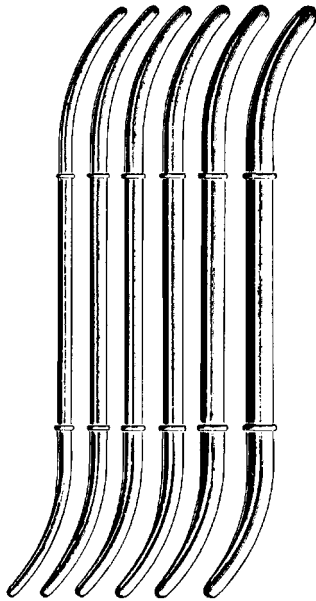
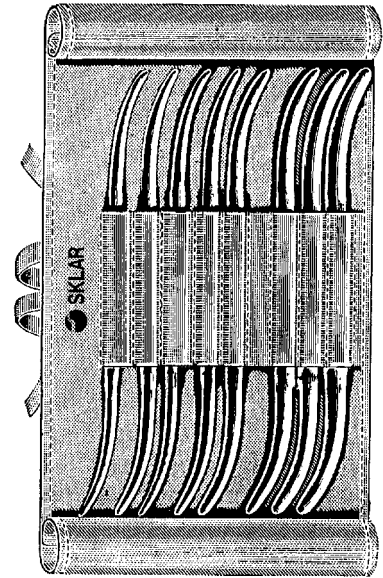
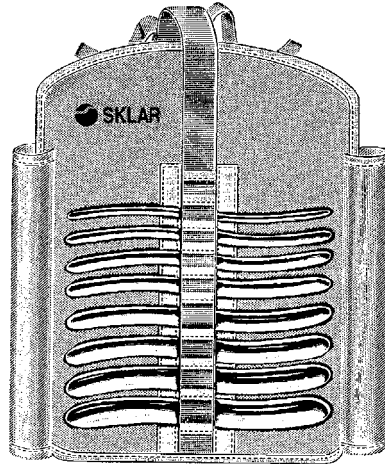
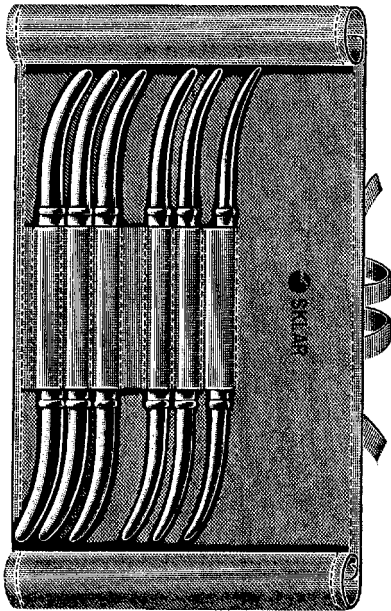
06-4142 2mm
06-4143 3mm
06-4144 4mm
06-4145 5mm
06-4146 6mm
06-4147 7mm
06-4148 8mm
06-4110 Keyes Punch Sharpener



SCHROEDER (BRAUN) TENACULUM FORCEPS

91-1290 9½"
91-1298 10¼" Pozzi

GYNECOLOGICAL INSTRUMENTS



HANK UTERINE DILATOR

- 90-4925 Set of 6 without Khaki Roll
 90-4926 Set of 6 with Khaki Roll

American Scale

- 90-4910 9-10
 90-4912 11-12
 90-4914 13-14
 90-4916 15-16
 90-4918 17-18
 90-4920 19-20

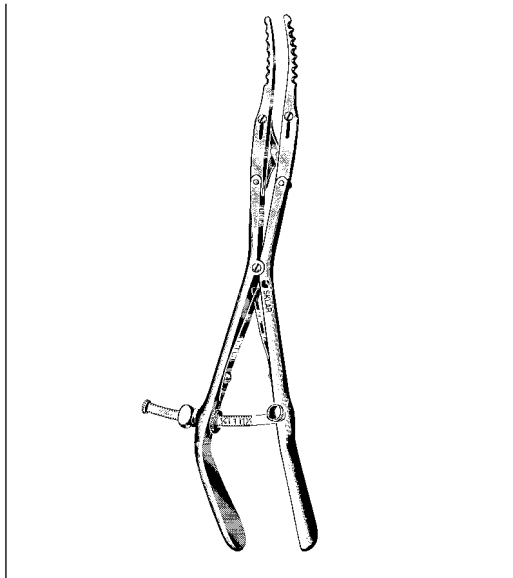
HEGAR UTERINE DILATOR

- 90-4825 Set of 8 without Khaki Roll, Double End
 90-4826 Set of 8 with Khaki Roll, Double End

Double End	Single Sizes-Single End
90-4804 $\frac{3}{4}$ mm	90-4784 1.0 mm
90-4806 $\frac{5}{8}$ mm	90-4785 1.5 mm
90-4808 $\frac{7}{8}$ mm	90-4786 2.0 mm
90-4810 $\frac{9}{10}$ mm	90-4787 2.5 mm
90-4812 $1\frac{1}{2}$ mm	90-4788 3.0 mm
90-4814 $1\frac{3}{4}$ mm	90-4789 3.5 mm
90-4816 $1\frac{5}{8}$ mm	90-4790 4.0 mm
90-4818 $1\frac{7}{8}$ mm	90-4791 4.5 mm
	90-4792 5.0 mm
	90-4793 5.5 mm
	90-4794 6.0 mm
	90-4795 6.5 mm
	90-4796 7.0 mm
	90-4797 7.5 mm
	90-4798 8.0 mm

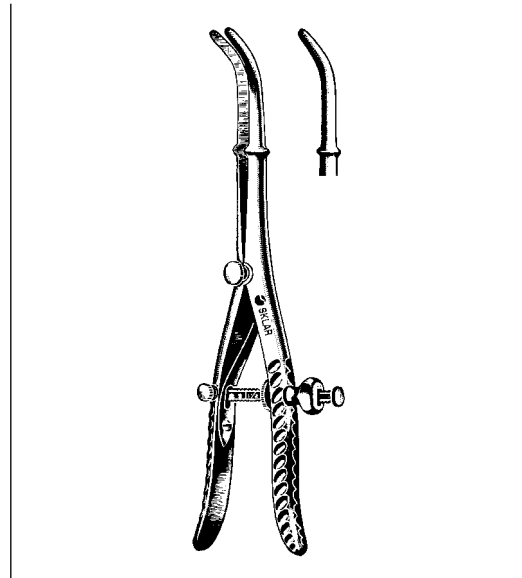
PRATT UTERINE DILATOR

- 90-5250 Set of 8
 90-5215 13-15 French
 90-5219 17-19 French
 90-5223 21-23 French
 90-5227 25-27 French
 90-5231 29-31 French
 90-5235 33-35 French
 90-5239 37-39 French
 90-5243 41-43 French



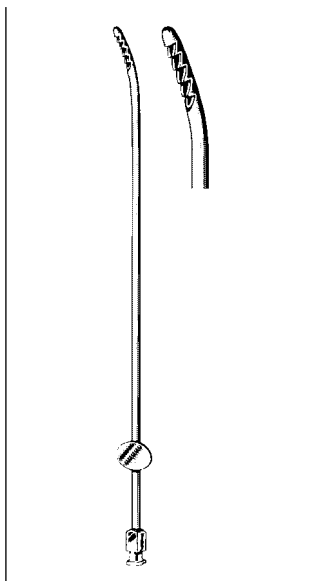
**GOODELL UTERINE
DILATOR**

90-4713 13"



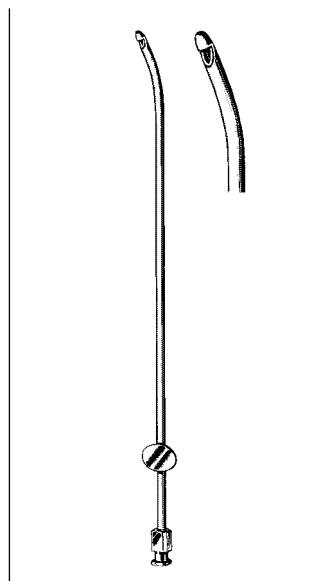
**WYLIE UTERINE
DILATOR**

90-4212 12" Smooth
90-4312 12" Corrugated



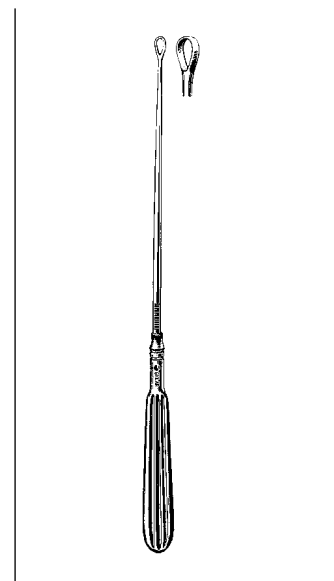
**NOVAK ENDOMETRIAL
CURETTE**

90-6290 9½" 2mm
90-6292 9½" 4mm



**RANDALL
ENDOMETRIAL CURETTE**

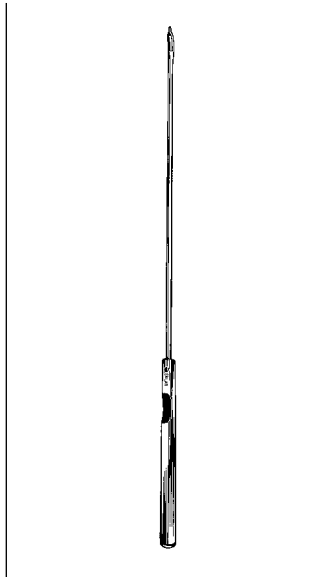
90-6295 9½"



**HOLDEN UTERINE
CURETTE**

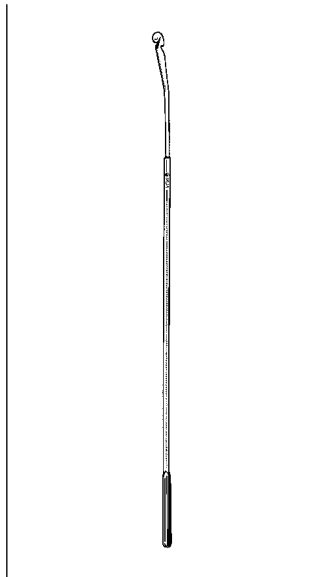
Semi-Sharp
90-5710 10¾" Extra Small

GYNECOLOGICAL INSTRUMENTS



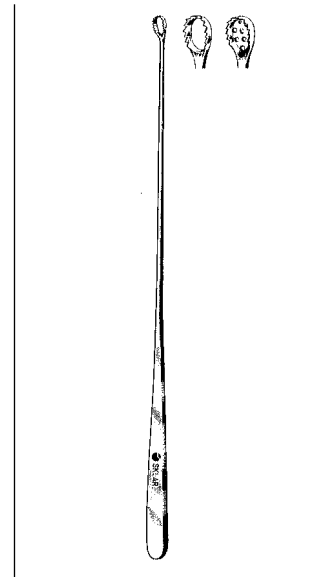
**SKLAR MINI
ENDOCERVICAL CURETTE**

90-6285 Small rounded tip for easier entry into stenosed cervix



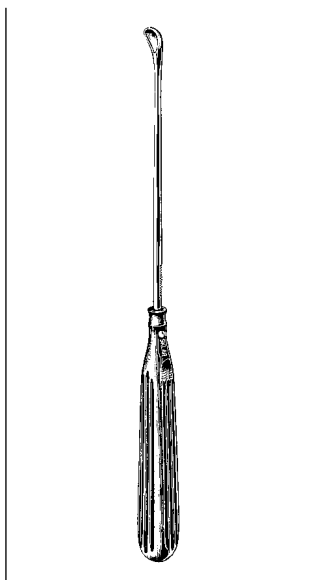
IUD EXTRACTOR

90-8210 10½"



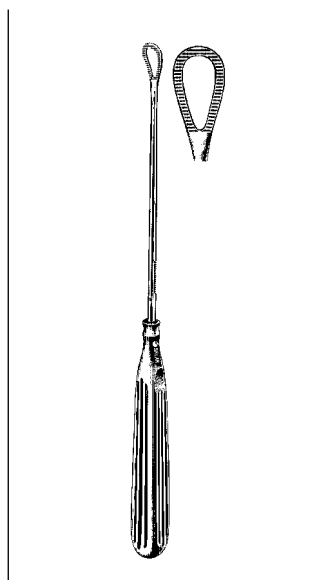
**HEANEY UTERINE
CURETTE**

Serrated
90-6095 9½" Open Curette
90-6195 9½" With Basket



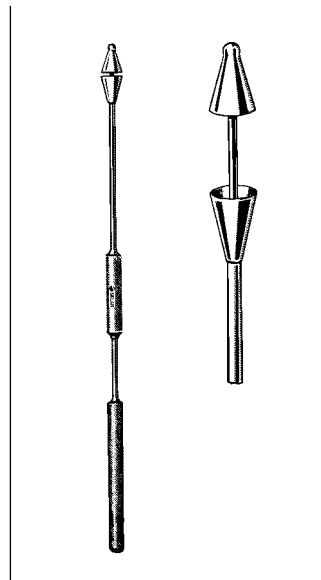
**SKENE UTERINE
CURETTE**

90-5542 10½"



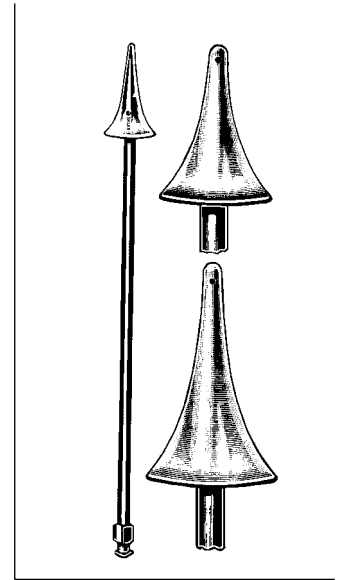
**GREENE UTERINE
CURETTE**

90-5566 11" Serrated



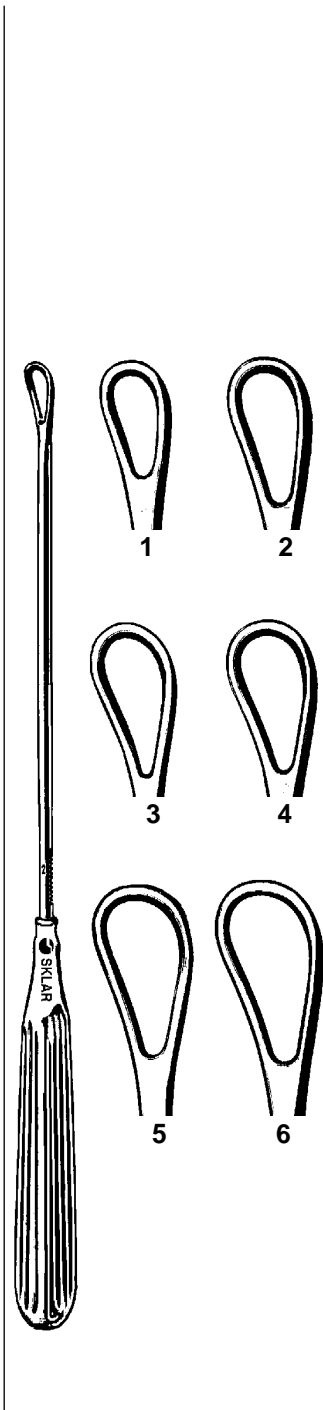
**GUSBERG
ENDOCERVICAL
CURETTE**

90-7195 Medium 9½"



**HOLMAN-MATHIEU
CANNULA**

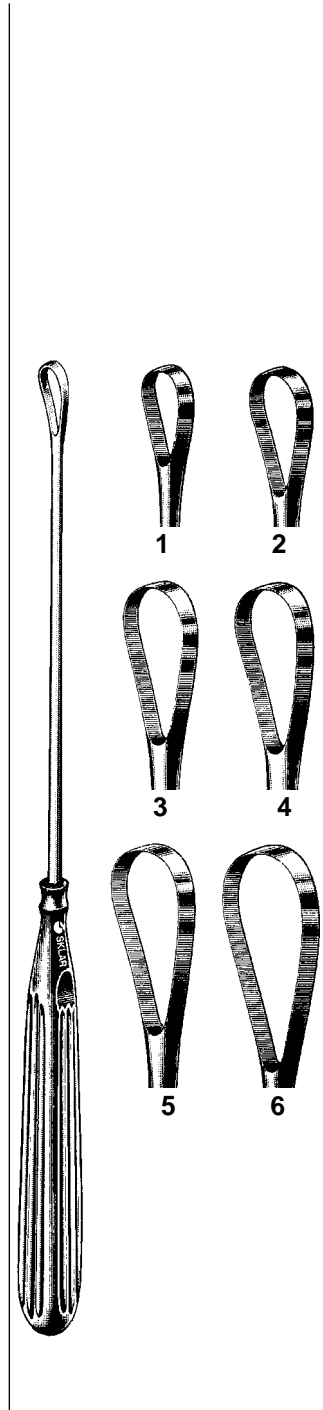
For Histerosalphingography
90-6582 8½" (21cm)
With Luer-Lok Hub
Chrome Plated Small Size
90-6590 9" (22.9cm)
Large Size



THOMAS UTERINE CURETTES

Blunt, 11"

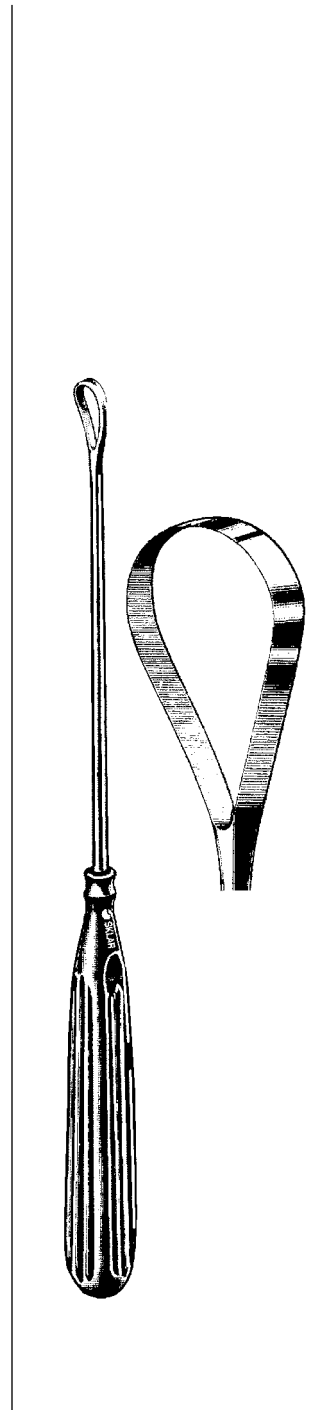
- 90-5431 No. 1
- 90-5432 No. 2
- 90-5433 No. 3
- 90-5434 No. 4
- 90-5435 No. 5
- 90-5436 No. 6
- 90-5438 Set of 6



SIMS UTERINE CURETTES

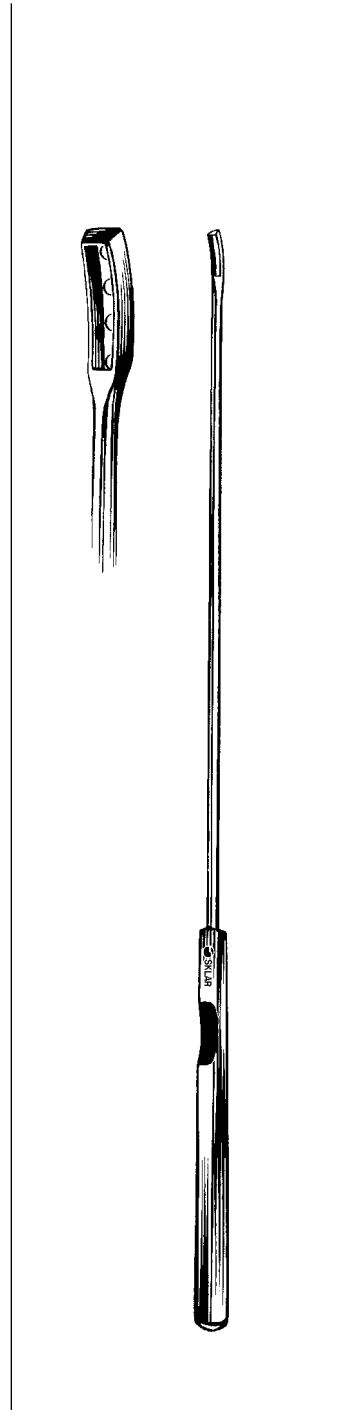
Sharp, 11"

- 90-5421 No. 1
- 90-5422 No. 2
- 90-5423 No. 3
- 90-5424 No. 4
- 90-5425 No. 5
- 90-5426 No. 6
- 90-5428 Set of 6



LOUNSBURY PLACENTA CURETTE

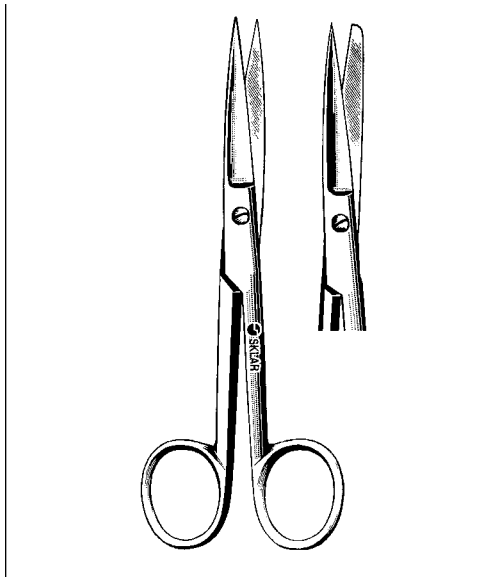
90-5713 11" $\frac{3}{4}$ " Wide



KEVORKIAN-YOUNGE ENDOCERVICAL CURETTE

Narrow Tip

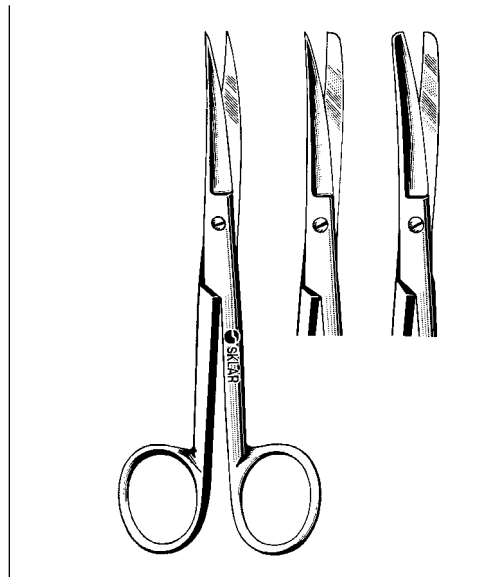
- 90-6611 12" Standard Model
- 90-6612 12" With Basket



OPERATING SCISSORS

Straight

S/S		S/B	
13-1055	5½"	14-1055	5½"
13-1060	6"	14-1060	6"
13-1065	6½"	14-1065	6½"



OPERATING SCISSORS

Curved

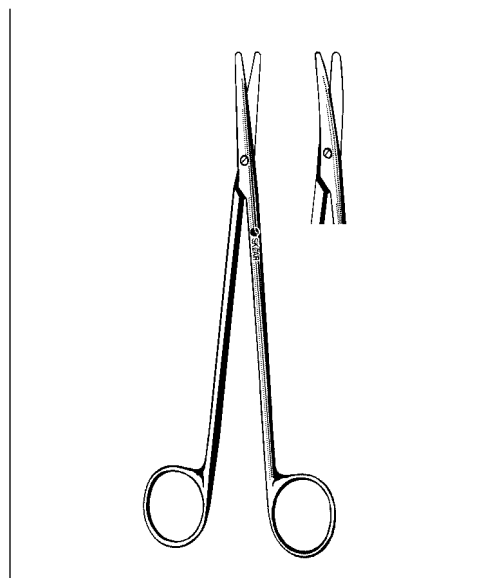
S/S		S/B		B/B	
13-2055	5½"	14-2055	5½"		
13-2060	6"	14-2060	6"	15-2060	6"
13-2065	6½"	14-2065	6½"	15-2065	6½"



METZENBAUM DISSECTING SCISSORS

Straight

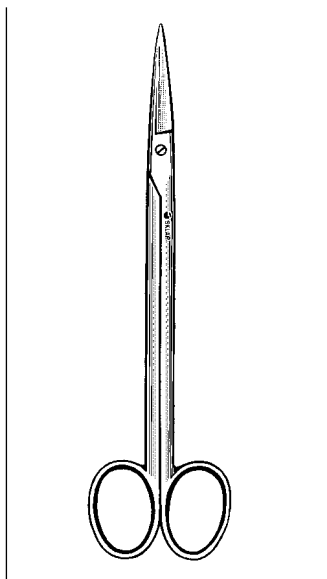
		Curved	
75-5570	7"	75-5670	7"
55-9180	8" (Nelson)	55-9080	8" (Nelson)
55-9190	9" (Nelson)	55-9090	9" (Nelson)
55-9310	10" (Nelson)	55-9210	10" (Nelson)
55-9311	11" (Nelson)	55-9411	11" (Nelson)
		55-9612	12" (Nelson)



METZENBAUM DISSECTING SCISSORS DELICATE

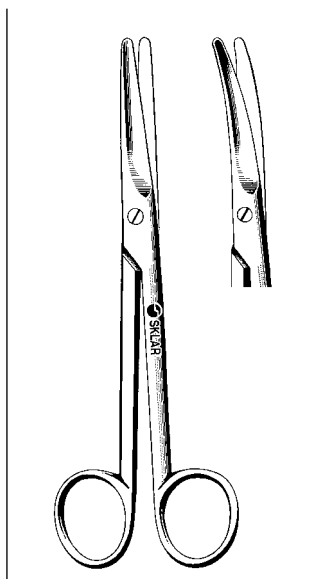
Curved

22-1070	7"
55-9084	8" (Nelson)
55-9094	9" (Nelson)



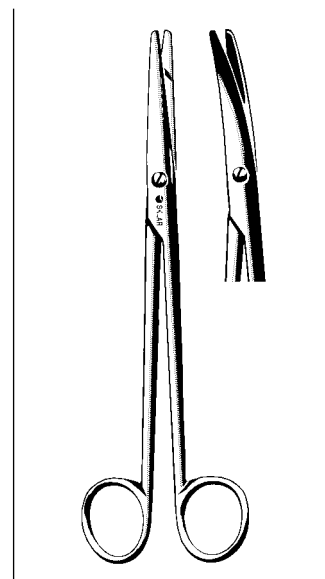
KELLY-ADSON SCISSORS

50-4562	6 1/4"	Smooth/Straight
50-4563	6 1/4"	Serrated/Straight
50-4662	6 1/4"	Smooth/Curved



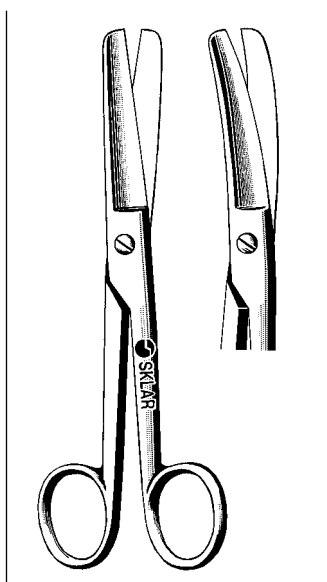
MAYO DISSECTING SCISSORS

Straight		Curved	
15-1555	5 1/2"	15-2555	5 1/2"
15-1567	6 3/4"	15-2567	6 3/4"
90-1590	9"	90-1690	9"
55-8711	11"	55-8611	11"



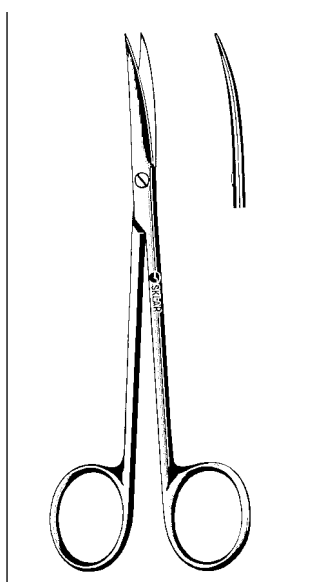
MAYO-STILLE DISSECTING SCISSORS ROUNDED BLADES

Straight		Curved	
15-1655	5 1/2"	15-2655	5 1/2"
15-1667	6 3/4"	15-2667	6 3/4"



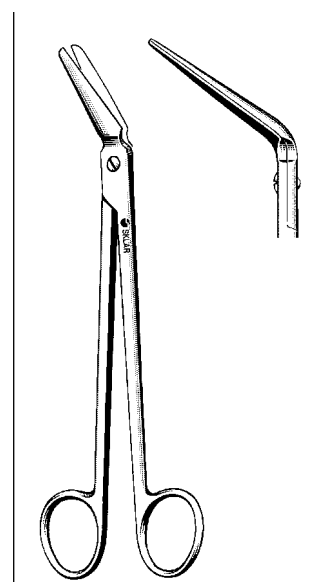
DOYEN SCISSORS

Straight		Curved	
15-1307	7" Smooth	15-2307	7" Smooth
15-1308	7" Serrated	15-2308	7" Serrated



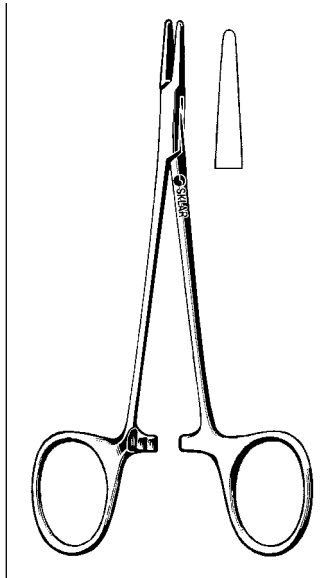
SULLIVAN SCISSORS

22-2755	5 1/4" Serrated
---------	-----------------



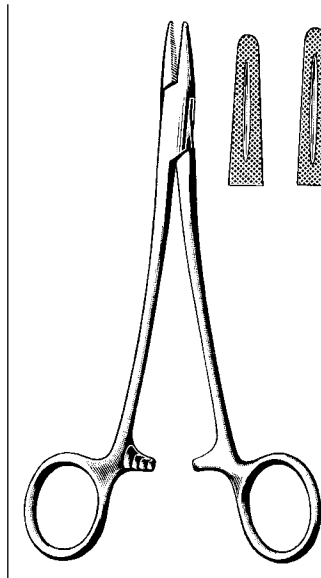
SWEET SCISSORS 45° ANGLE

55-8380	8"
---------	----



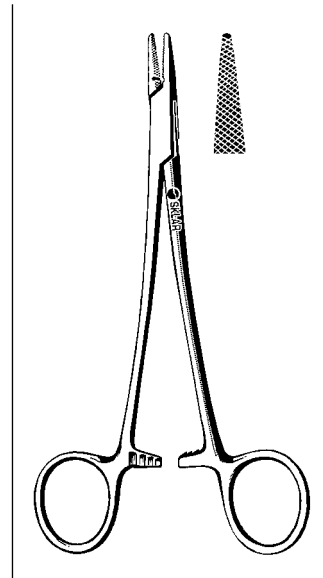
WEBSTER NEEDLE HOLDER

20-1352 5" (13cm) Serrated Jaw
20-1350 5" (13cm) Smooth Jaw



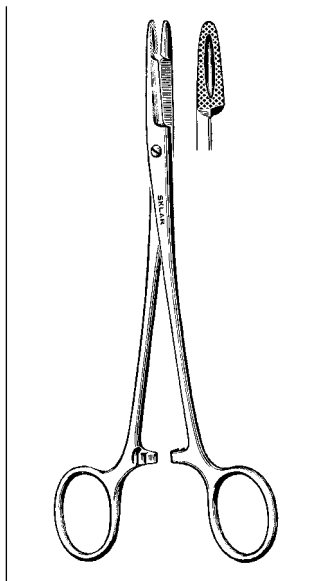
MAYO-HEGAR NEEDLE HOLDER

Serrated
20-2480 8"
20-2910 10½" Masson
20-2070 7"



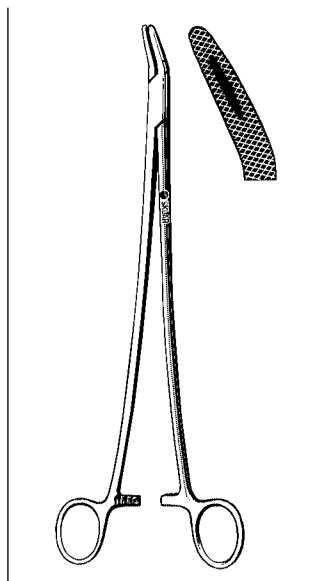
CRILE-WOOD NEEDLE HOLDER

Serrated
20-1270 7" DeBakey Type
20-1280 8" DeBakey Type
20-1290 9" DeBakey Type
20-1295 10½" DeBakey Type



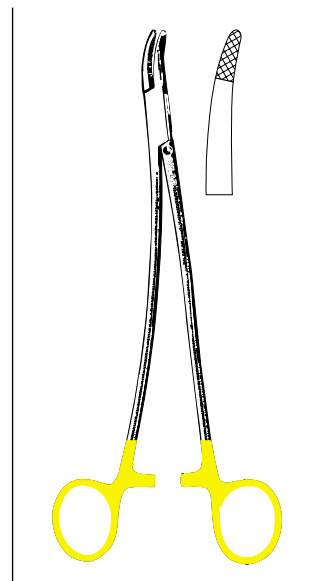
OLSEN-HEGAR NEEDLE HOLDER

Scissors combination
20-2765 6½"
20-2775 7"



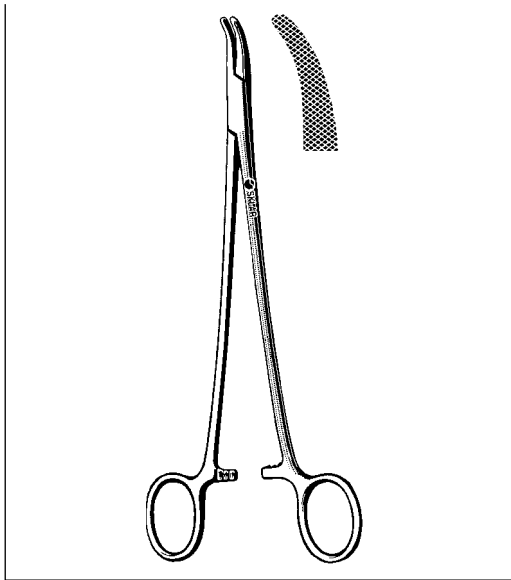
FINOCHIETTO NEEDLE HOLDER

20-4510 10¼"



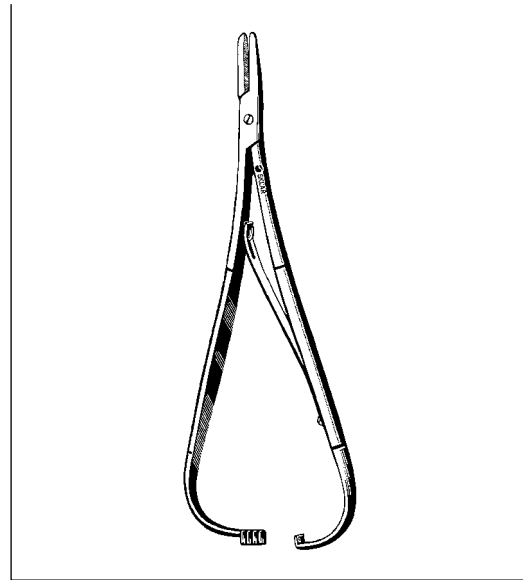
STRATTE NEEDLE HOLDER

20-4795 9" Standard
21-8065 9" Tungsten Carbide



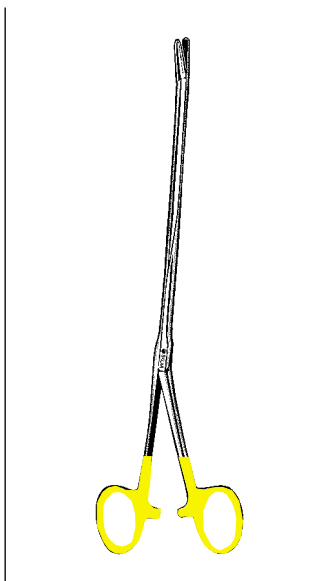
HEANEY NEEDLE HOLDER

20-4682 8 1/4"



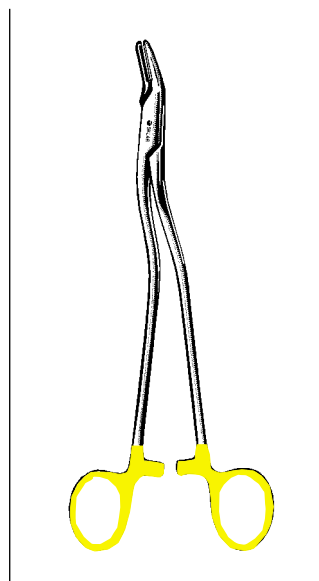
MATHIEU NEEDLE HOLDER

20-3075 7 1/2" Standard
20-8071 7 1/2" Tungsten Carbide



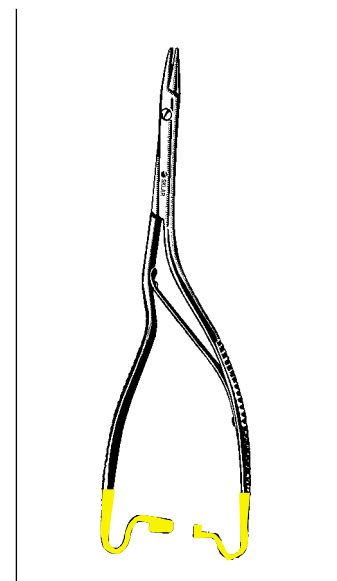
**T-C ANASTOMOSIS
NEEDLE HOLDER**

21-8078 9 1/4" (23.5cm)
Tungsten Carbide



**T-C BOZEMAN-HEANEY
NEEDLE HOLDER**

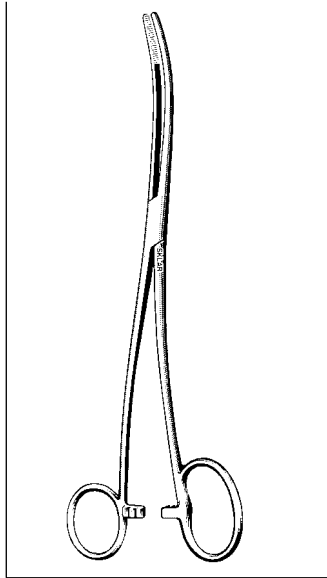
21-8062 10 1/2" (26.5cm)
Tungsten Carbide



**T-C LUETHY-BECK
NEEDLE HOLDERS**

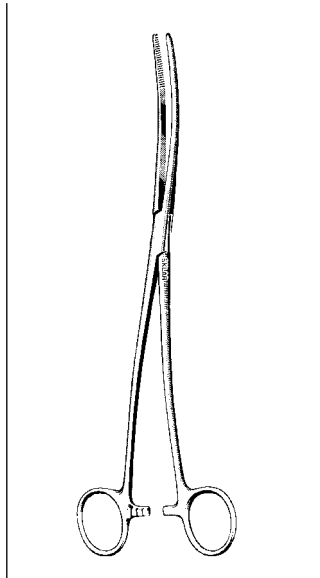
21-8064 8" (20cm)
Tungsten Carbide

GYNECOLOGICAL INSTRUMENTS



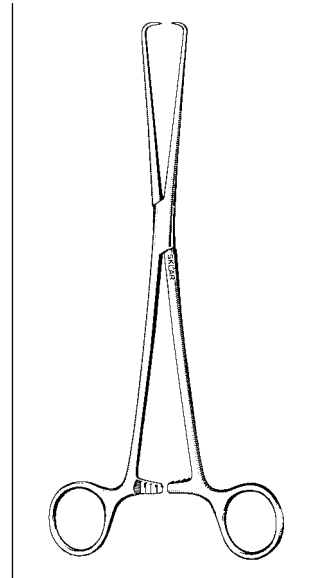
BOZEMAN FORCEPS

One Large Ring
90-7710 10¼" S-Curve



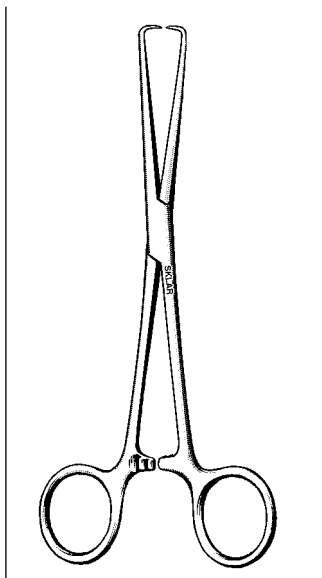
BOZEMAN FORCEPS

90-7610 10½" Straight
80-1410 10¼" S-Curve



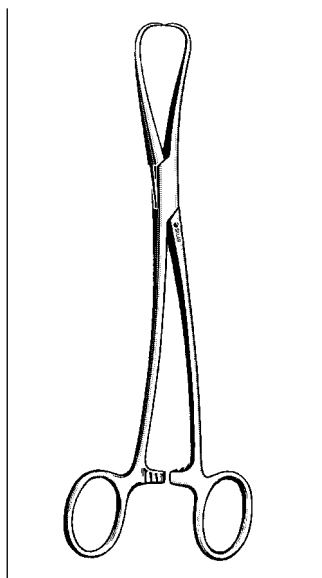
SCHROEDER (BRAUN) TENACULUM FORCEPS

91-1290 9½"
91-1298 10¼" Pozzi



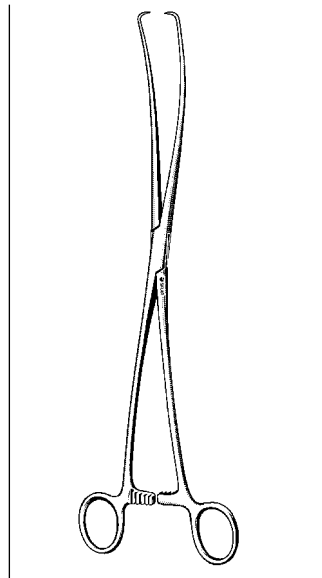
BARRETT TENACULUM FORCEPS

91-1070 7"



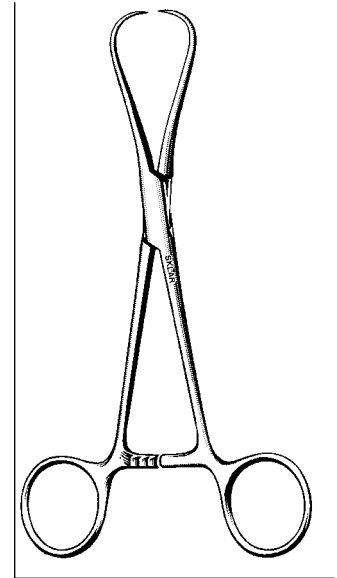
JARCHO TENACULUM FORCEPS

91-1275 7½" Double Curve



DUPLAY TENACULUM FORCEPS

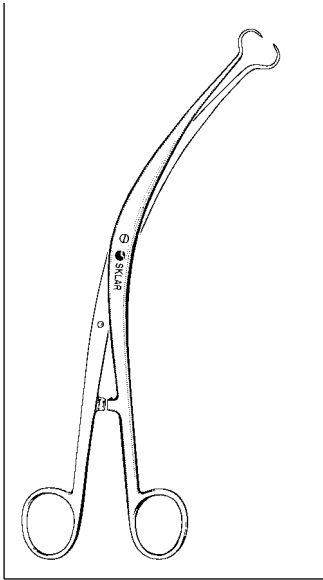
91-1111 11" S-Curve



STAUDE TENACULUM FORCEPS

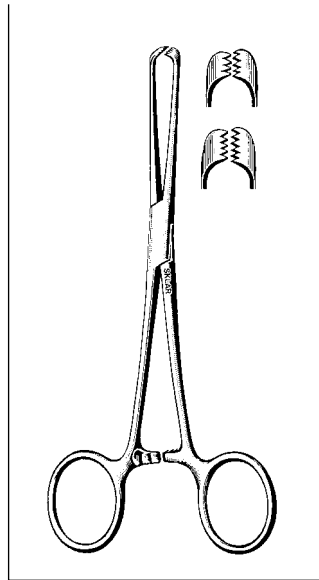
91-1455 5½"

Staude-Moore
91-1465 6½"



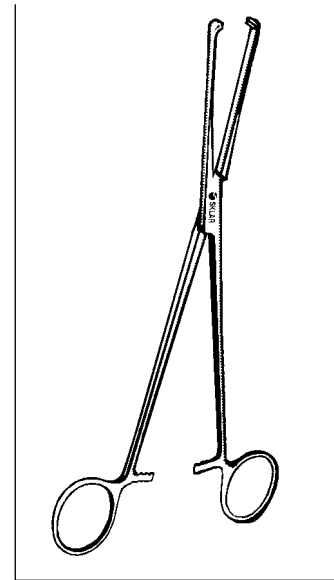
**GRAVES TENACULUM
FORCEPS**

91-2598 9" Curved Sideways



**ALLIS TISSUE FORCEPS
DELICATE**

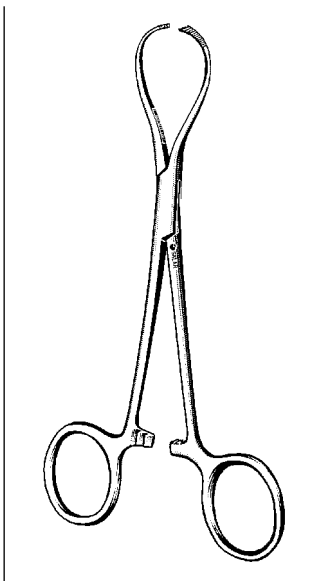
18-2140 4" 4 x 5
18-2155 5" 4 x 5
18-2162 6" 4 x 5
18-2164 6" 5 x 6
36-2275 7½" 5 x 6
36-2295 9½" 5 x 6



ALLIS FORCEPS

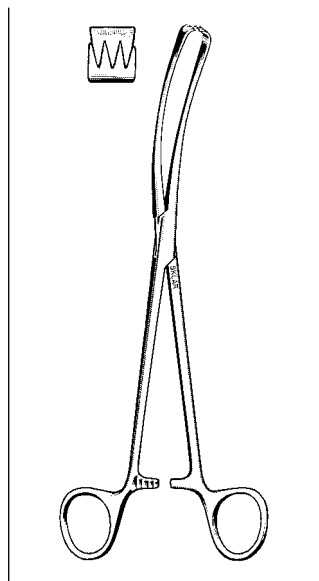
With Atraumatic Jaws

36-2298 10" Straight
36-2385 6" Straight



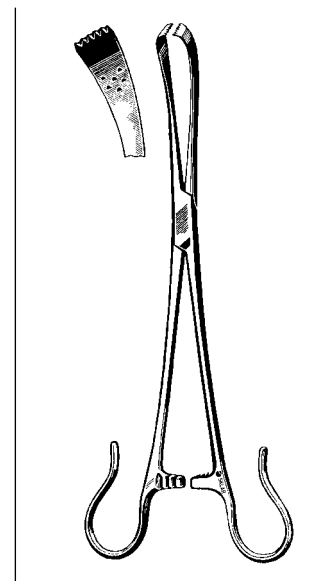
**ABRAMSON-ALLIS
FORCEPS**

Small Jaw
91-1562 5½"



**TEALE VULSELLUM
FORCEPS**

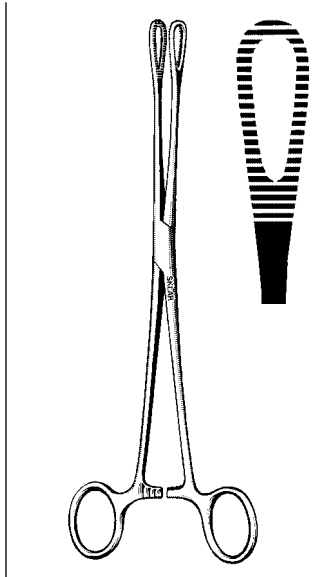
Curved Sideways
91-2695 9" 3 x 4 teeth



CRAIG FORCEPS

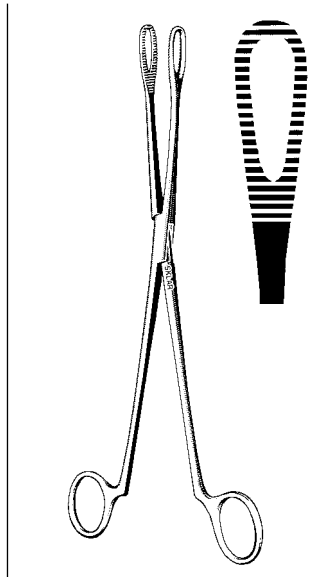
74-1280 8" 2 Open Rings

GYNECOLOGICAL INSTRUMENTS



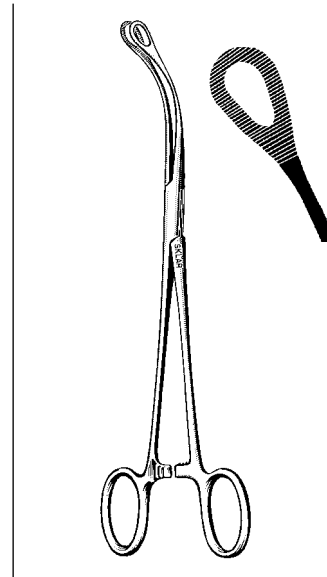
SCHWEIZER FORCEPS

90-7995 9½" Straight



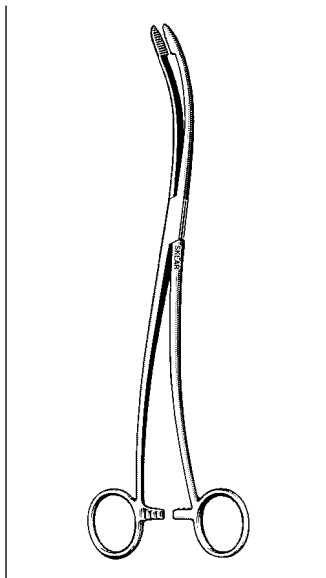
CLEMENTSON FORCEPS

90-7895 9½" Straight
No Ratchet



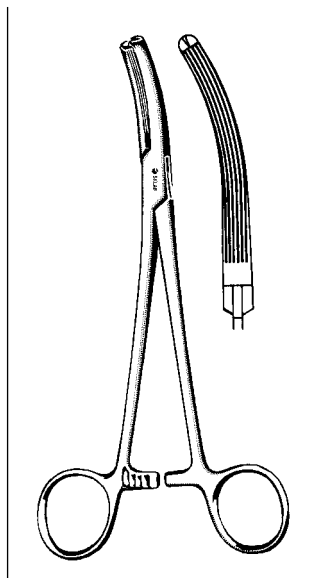
LAFE UTERINE POLYP FORCEPS

90-7977 7¾" Curved



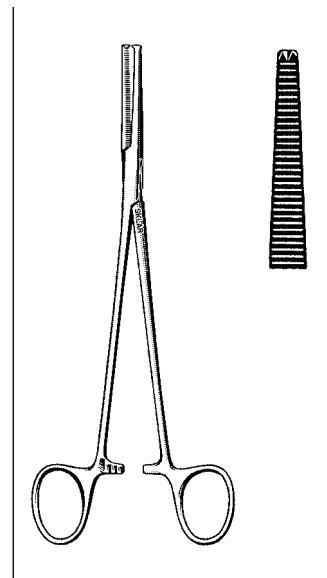
DELEE UTERINE FORCEPS

90-8111 11" Heavy



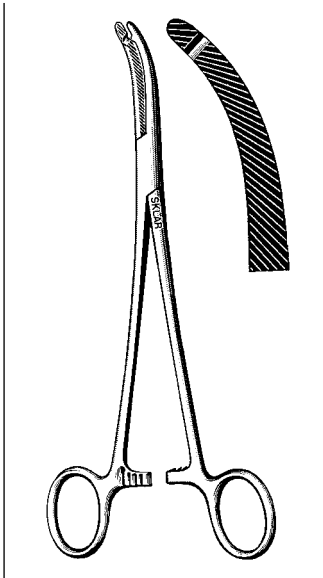
LONG FORCEPS

90-2690 7½"



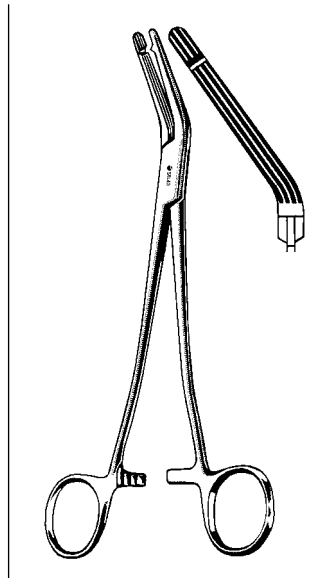
PHANEUF FORCEPS

90-2682 8¾"



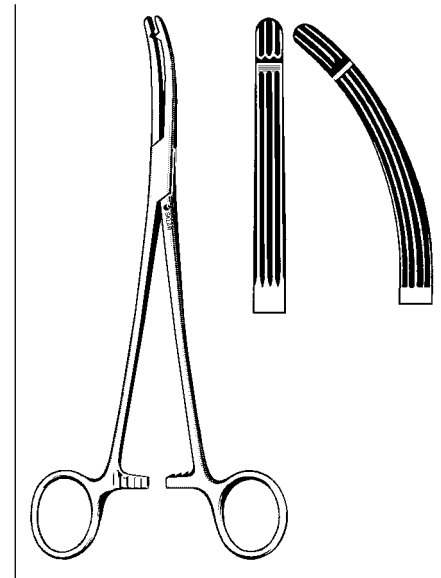
HEANEY FORCEPS

90-2177 7 $\frac{3}{4}$ "



LAWTON FORCEPS

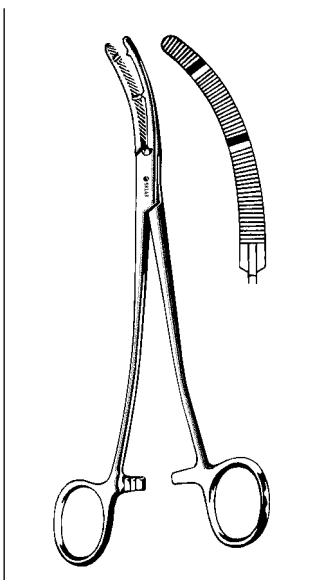
90-2180 8 $\frac{1}{4}$ "



HEANEY-BALLENTINE FORCEPS

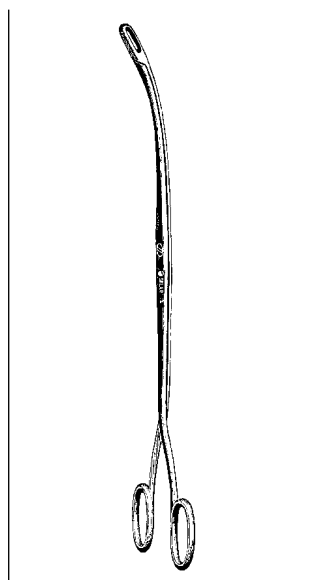
Longitudinal Serrations

90-2480	8"	Straight
90-2580	8"	Curved
90-2582	8"	Angular



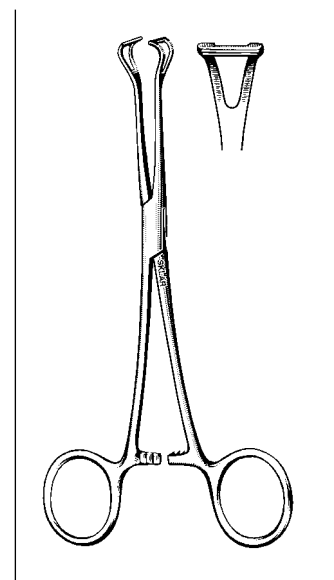
HEANEY-KANTER FORCEPS

90-2379 8 $\frac{1}{4}$ "



CAMPION FORCEPS

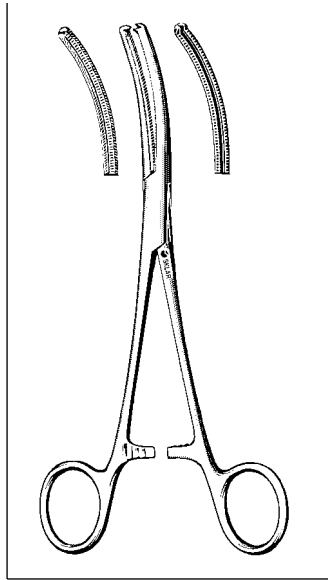
90-7898 9 $\frac{1}{4}$ " Curved



BABCOCK FORCEPS

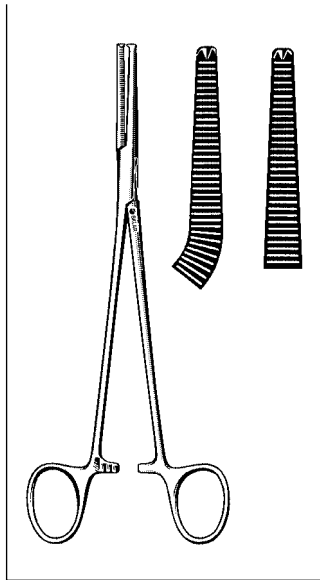
22-6155	5 $\frac{1}{2}$ "
36-1662	6 $\frac{1}{4}$ "
36-1677	8"
36-1692	9 $\frac{1}{2}$ "

GYNECOLOGICAL INSTRUMENTS



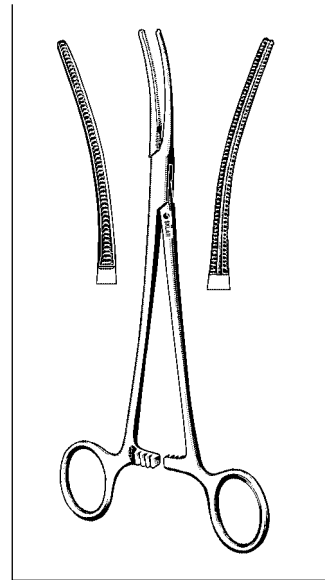
GELPI-LOWRIE FORCEPS

90-1885 8½"



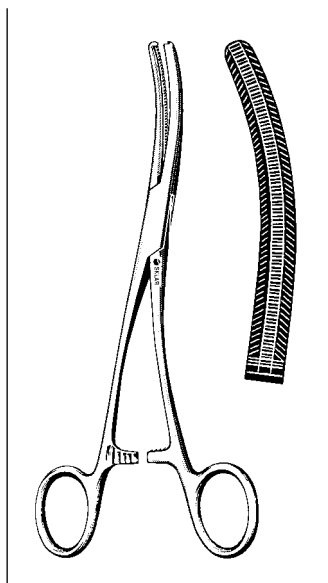
PHANEUF FORCEPS

90-2680 8½" Curved
90-2682 8½" Straight



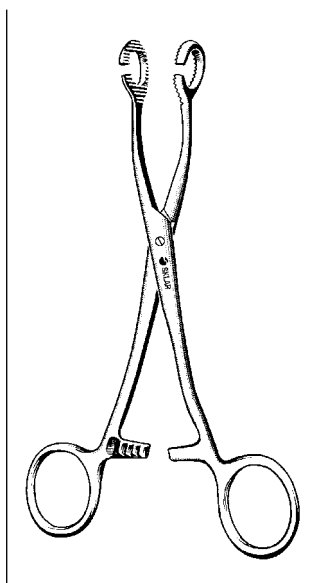
**GUSBERG
HYSTERECTOMY CLAMP**

90-2780 8" Curved



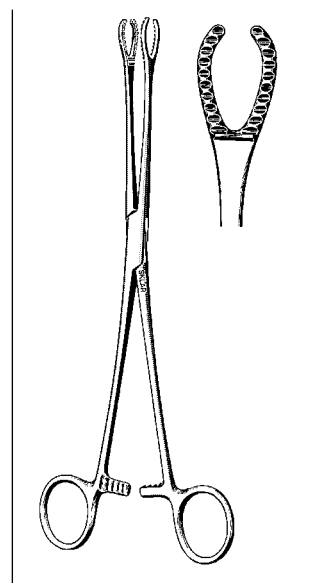
DE ALVAREZ CLAMP

90-2782 8½" Double Curve



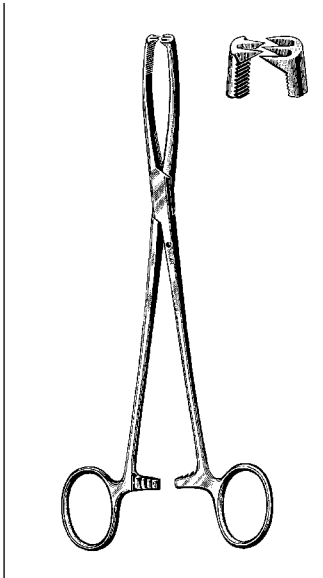
HILDEBRANDT FORCEPS

90-8065 6½"



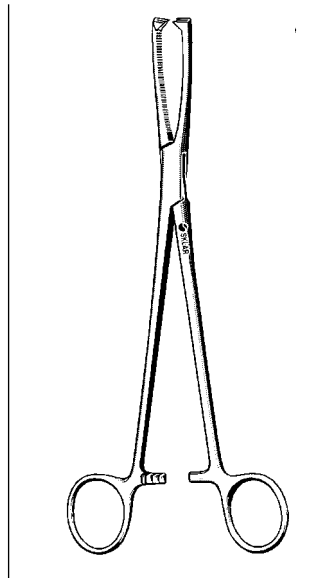
**GUTGLASS CERVIX
FORCEPS**

90-8090 9½"



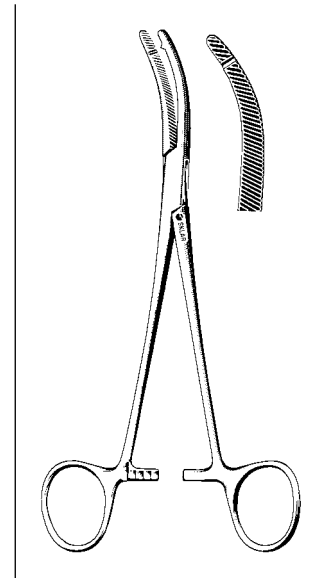
**HENROTIN VULSELLUM
FORCEPS**

91-2585 8½" 2 x 3 teeth



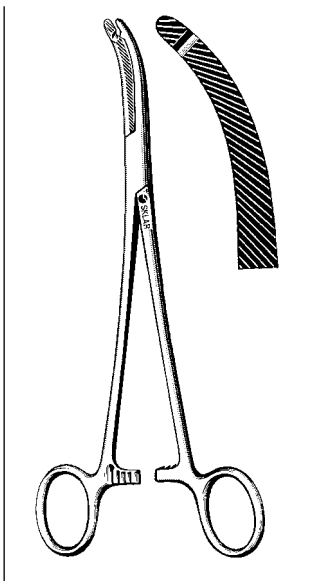
**DOYEN VULSELLUM
FORCEPS**

91-2482 8¼"



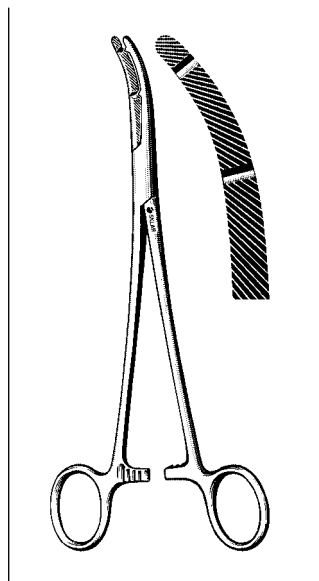
HEANEY FORCEPS

Single tooth
90-1977 7¾" Light Model



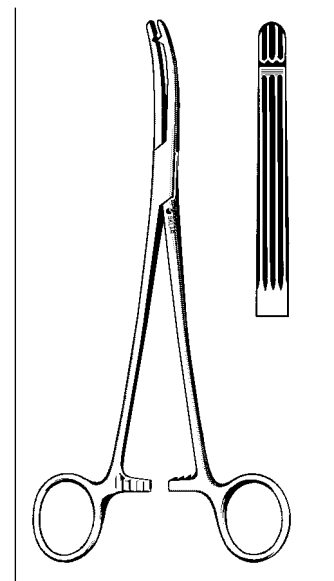
HEANEY FORCEPS

Single tooth
90-2177 8¾" Heavy Model



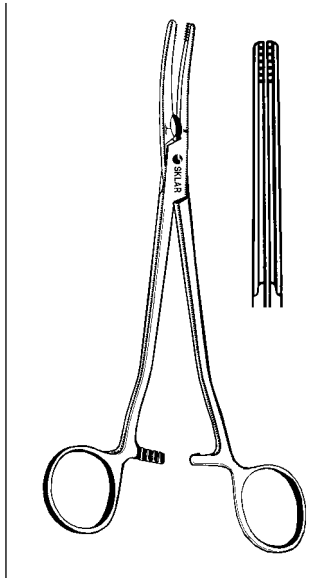
HEANEY FORCEPS

Heavy Double tooth
90-2280 8"
90-2387 8¾"



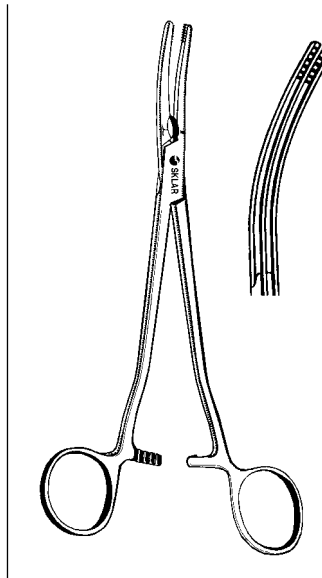
**HEANEY-BALLENTINE
FORCEPS**

90-2480 8" Straight
90-2580 8" Curved



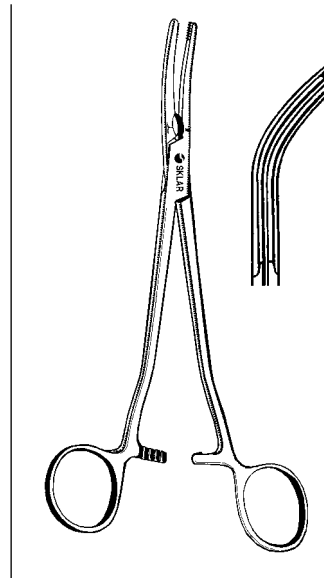
HYSTERECTOMY CLAMP

90-2790 9 1/2" Straight



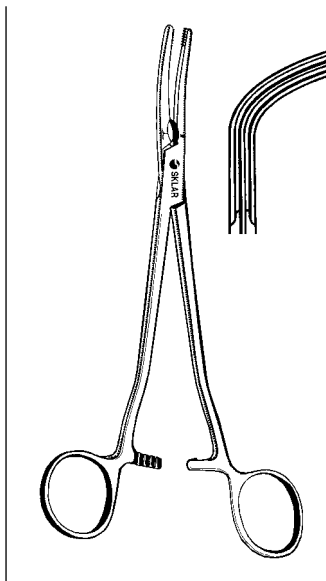
HYSTERECTOMY CLAMP

90-2792 9 1/2" Slight Curve



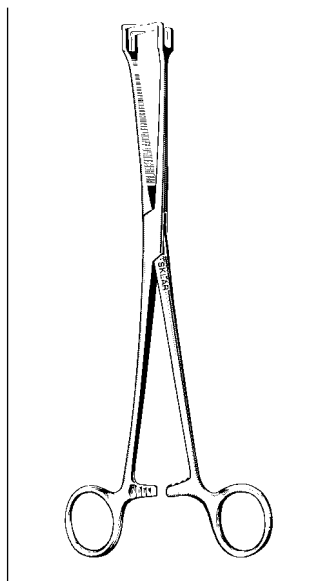
HYSTERECTOMY CLAMP

90-2794 9 1/2" Angular



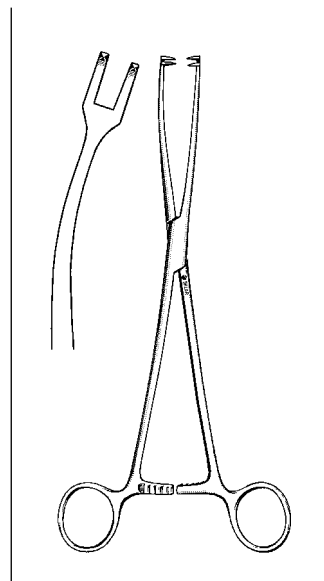
HYSTERECTOMY CLAMP

90-2793 9 1/2" Full Curve



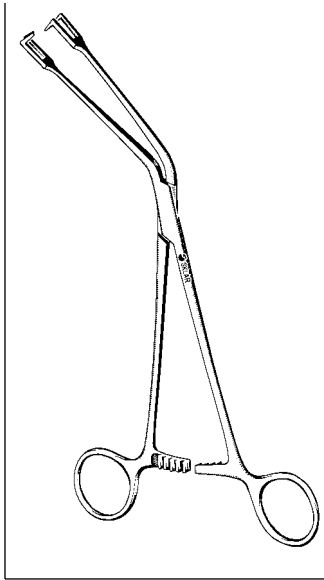
**SCHROEDER VULSELLUM
FORCEPS**

91-1590 9 1/2"



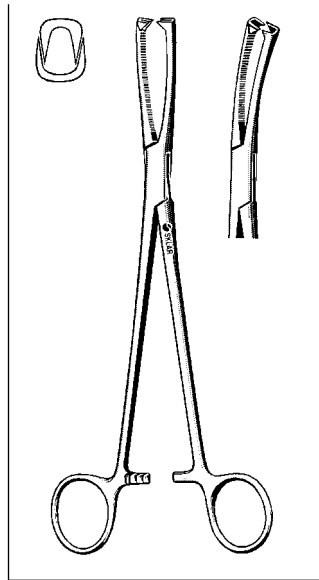
**SCHROEDER
VULSELLUM FORCEPS**

Curved
91-1690 9"



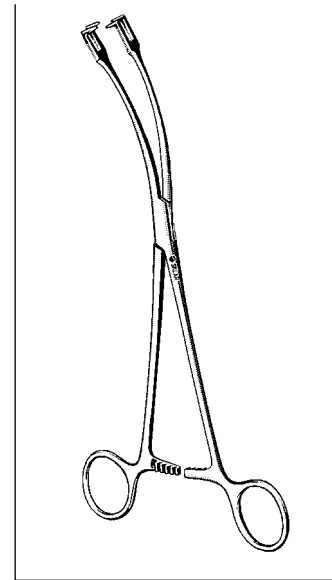
SCHROEDER VULSELLUM FORCEPS

Angled Sideways
91-1990 9"



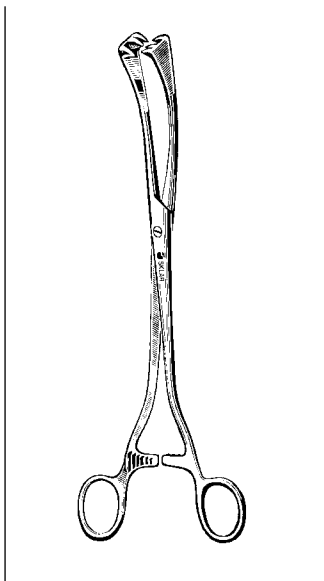
JACOBS VULSELLUM FORCEPS

Serrated Jaws
91-2282 8 1/2" Straight
91-2382 8 1/2" Angular



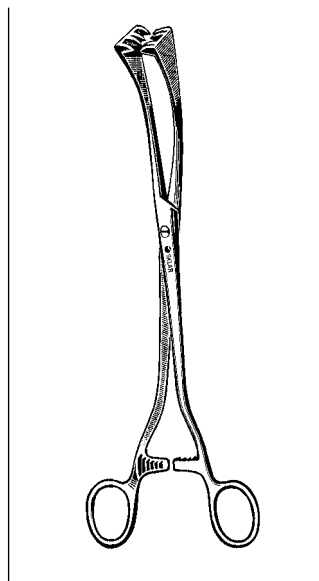
SCHROEDER VULSELLUM FORCEPS

Slight Curve Sideways
91-1890 9"



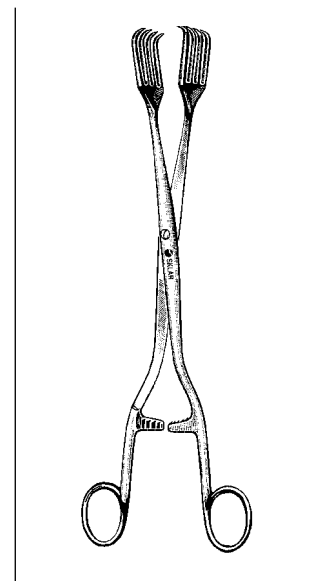
SECOND (COLLIN) FORCEPS

3 x 3 Teeth
91-3095 9 1/2" Straight
91-3195 9 1/2" Curved sideways



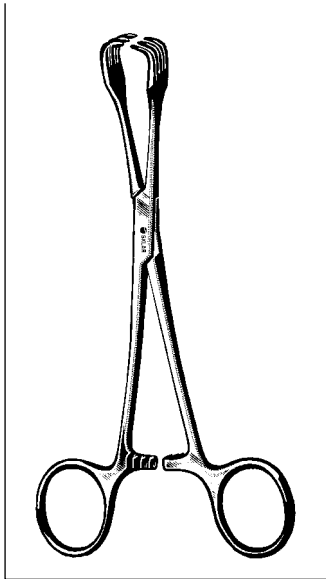
SECOND (COLLIN) FORCEPS

4 x 4 Teeth
91-3695 9 1/2" Curved sideways
91-3795 9 1/2" Curved on flat



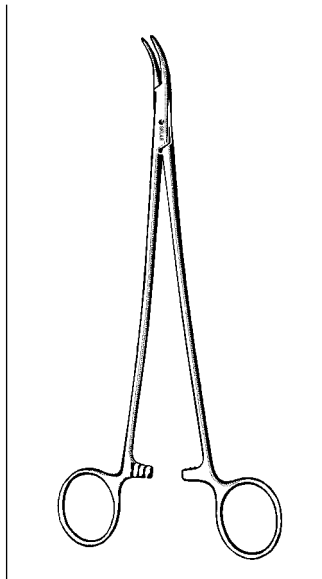
BILLROTH FORCEPS

91-3810 10 3/4" 4 x 4 teeth
91-3910 10 3/4" 3 x 3 teeth
Tumor Forceps



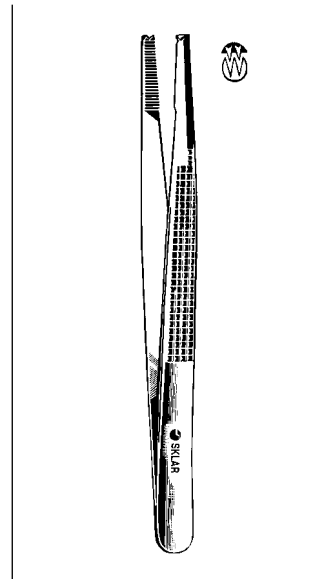
LAHEY TRACTION

17-3562 6 1/4" Light Pattern
91-2080 8" Regular Pattern (MGH)



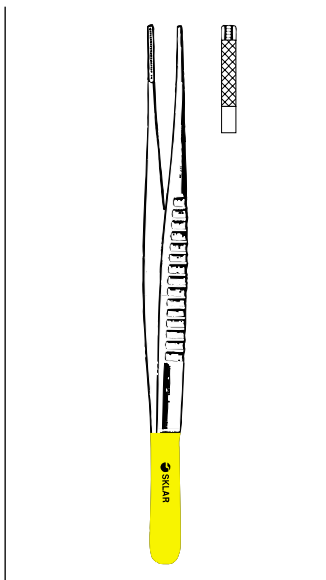
CLARK ARTERY FORCEPS

Side Curved
90-2354 8 3/4"



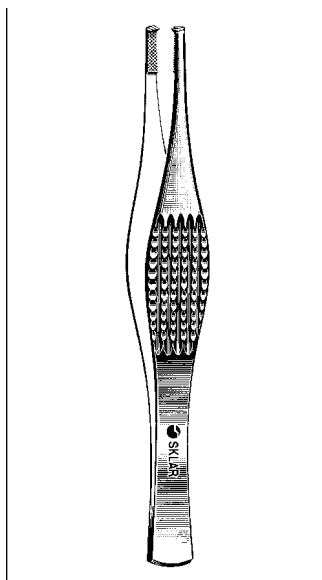
BONNEY TISSUE FORCEPS

1 x 2 Teeth
19-2170 7"



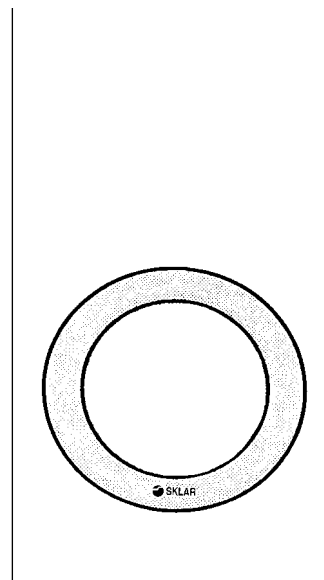
T-C DEBAKEY FORCEPS

97-1530 6" 2.0 mm Tips
97-1531 6" 2.7 mm Tips
97-1540 8" 2.0 mm Tips
97-1541 8" 2.7 mm Tips



FERRIS-SMITH TISSUE FORCEPS

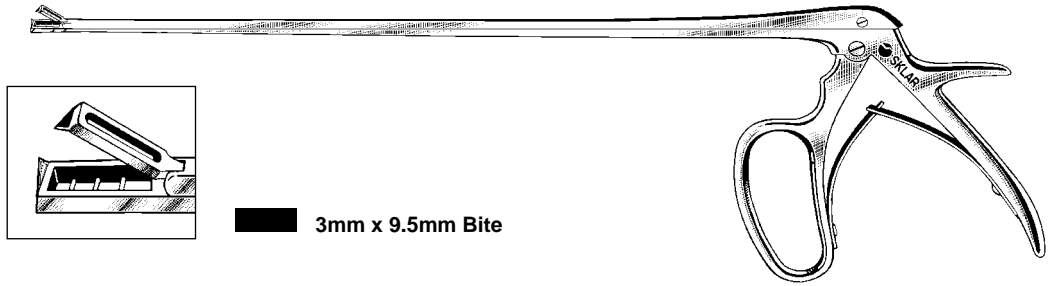
52-4070 7" 3 x 4 teeth
47-1470 7" 1 x 2 teeth



LAPAROTOMY RING

90-8715 1 1/2" ID
90-8717 1 3/4" ID

NEW!



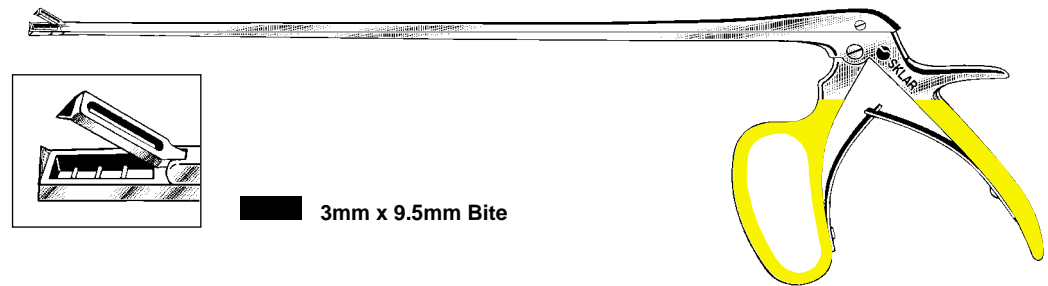
3mm x 9.5mm Bite

TISCHLER CERVICAL BIOPSY PUNCH
With Kevorkian Style Bite

90-6887

3mm x 9.5mm Bite

NEW!



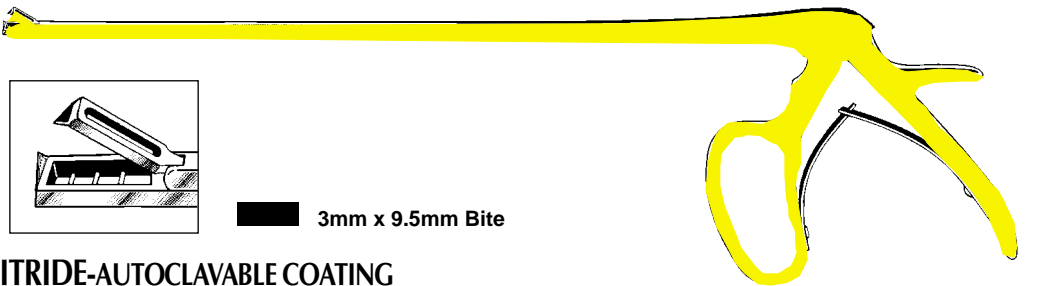
3mm x 9.5mm Bite

MICRO-CUT TISCHLER CERVICAL BIOPSY PUNCH
Micro-Cut with Kevorkian Style Bite

90-8920

3mm x 9.5mm Bite

NEW!



3mm x 9.5mm Bite

TITANIUM NITRIDE-AUTOCLAVABLE COATING

TISCHLER CERVICAL BIOPSY PUNCH

25-9005

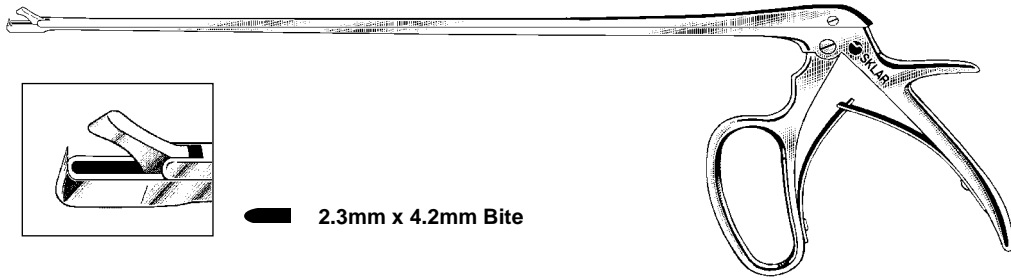
3mm x 9.5mm Bite

- Superior corrosion resistance
- Saves money-increased wear resistance results in extended life of the instrument
- Hardest possible ceramic coating provides the ultimate cutting edge

GYNECOLOGY BIOPSY FORCEPS



NEW!



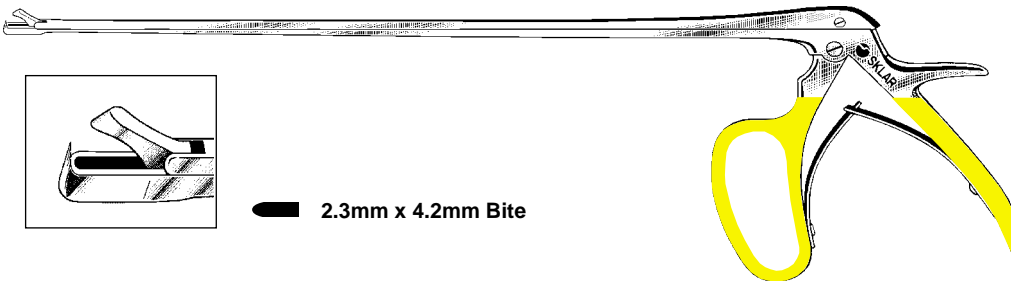
2.3mm x 4.2mm Bite

SKLAR MINI TISCHLER DELICATE PUNCH

90-7530

2.3mm x 4.2mm Bite (Baby Tischler)

NEW!



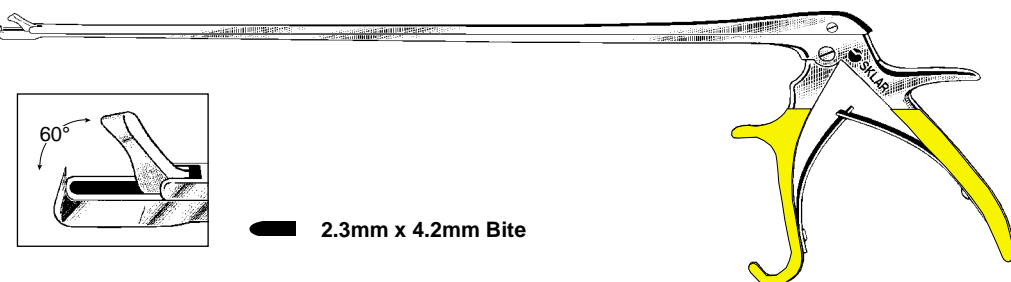
2.3mm x 4.2mm Bite

MICRO-CUT MINI TISCHLER DELICATE PUNCH

90-8945

2.3mm x 4.2mm Bite (Baby Tischler)

NEW!



2.3mm x 4.2mm Bite

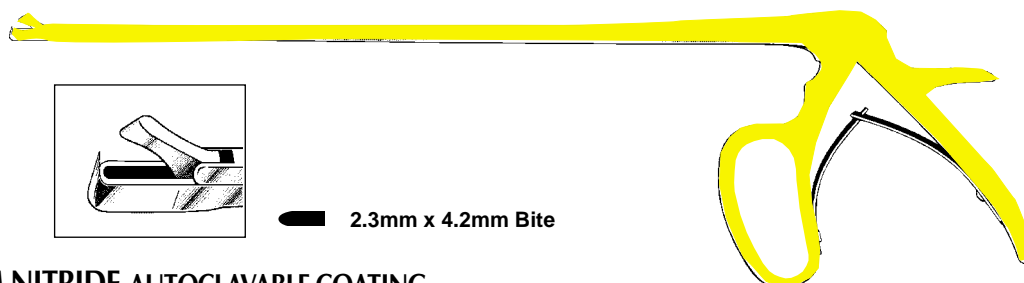
WIDE BITE MINI TISCHLER DELICATE PUNCH

90-9555

2.3mm x 4.2mm Bite (Baby Tischler)

Opens to 60° for easy removal of biopsy and safer cleaning

NEW!



2.3mm x 4.2mm Bite

TITANIUM NITRIDE-AUTOCLAVABLE COATING

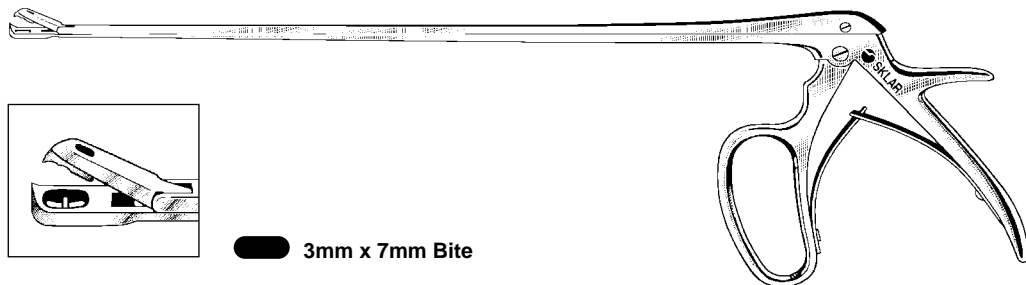
SKLAR MINI TISCHLER DELICATE PUNCH

25-9010

2.3mm x 4.2mm Bite (Baby Tischler)

- Superior corrosion resistance
- Saves money-increased wear resistance results in extended life of the instrument
- Hardest possible ceramic coating provides the ultimate cutting edge

NEW!

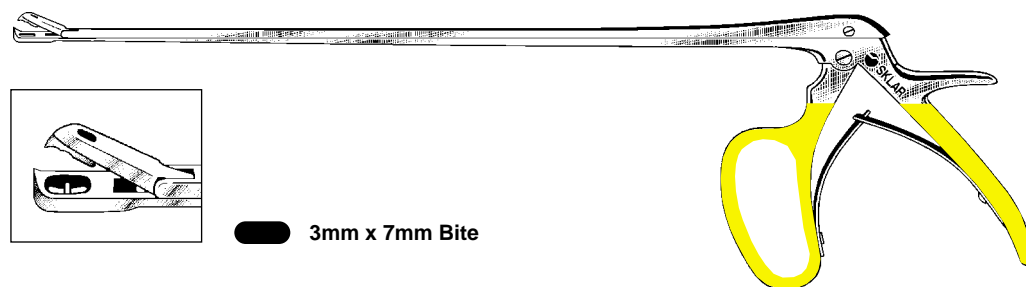


SKLAR TISCHLER OVAL BIOPSY PUNCH

90-7520

3mm x 7mm Bite

NEW!

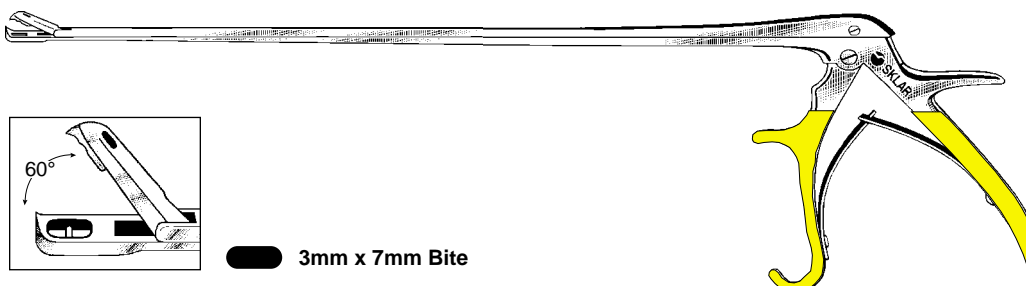


MICRO-CUT SKLAR TISCHLER OVAL BIOPSY PUNCH

90-8940

3mm x 7mm Bite

NEW!



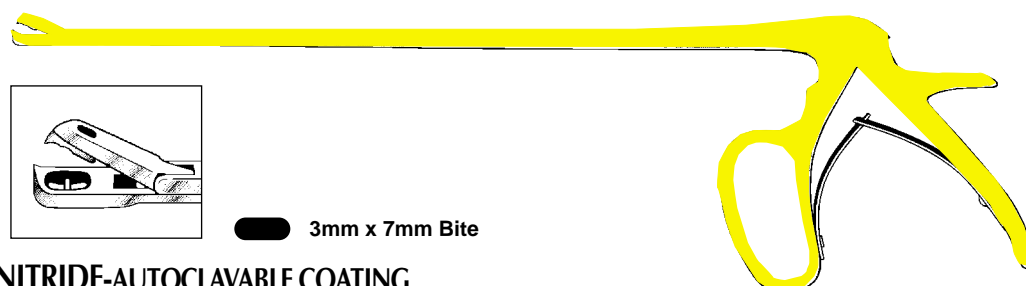
WIDE BITE SKLAR TISCHLER OVAL BIOPSY PUNCH

90-9560

3mm x 7mm Bite

Opens to 60° for easy removal of biopsy and safer cleaning

NEW!



TITANIUM NITRIDE-AUTOCALVABLE COATING

SKLAR TISCHLER OVAL BIOPSY PUNCH

25-9015

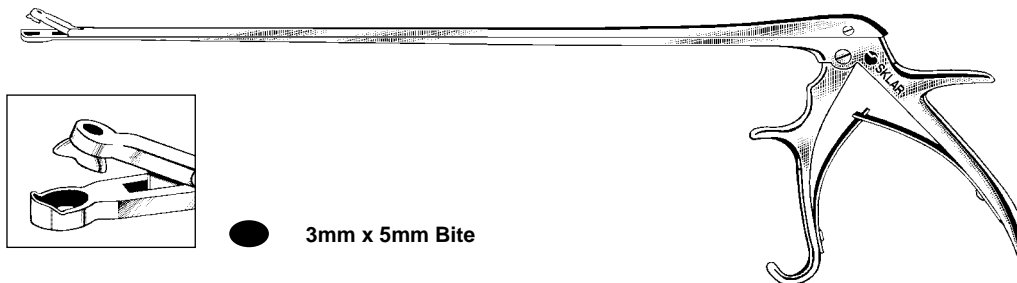
3mm x 7mm Bite

- Superior corrosion resistance
- Saves money-increased wear resistance results in extended life of the instrument
- Hardest possible ceramic coating provides the ultimate cutting edge

OBSTETRICAL- GYNECOLOGY BIOPSY FORCEPS



NEW!

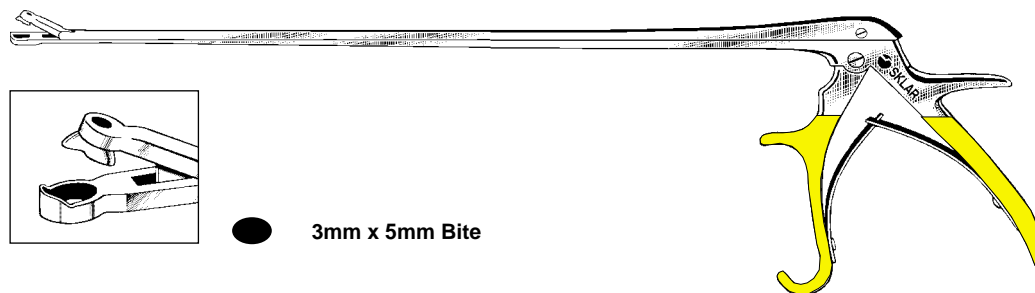


SKLAR OVAL BIOPSY PUNCH

90-7525

3mm x 5mm Bite

NEW!

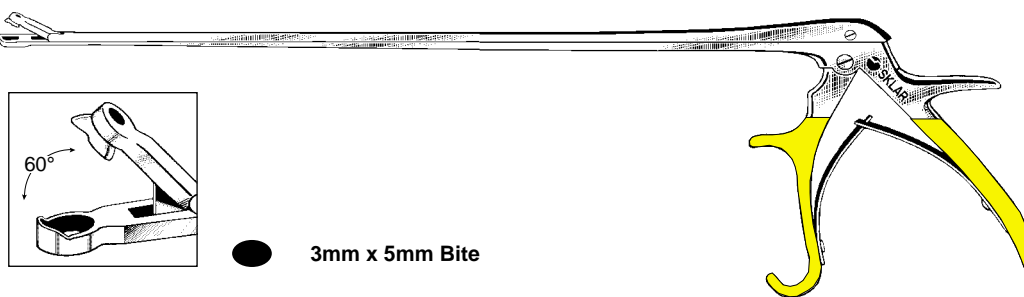


MICRO-CUT SKLAR OVAL BIOPSY PUNCH

90-8948

3mm x 5mm Bite

NEW!



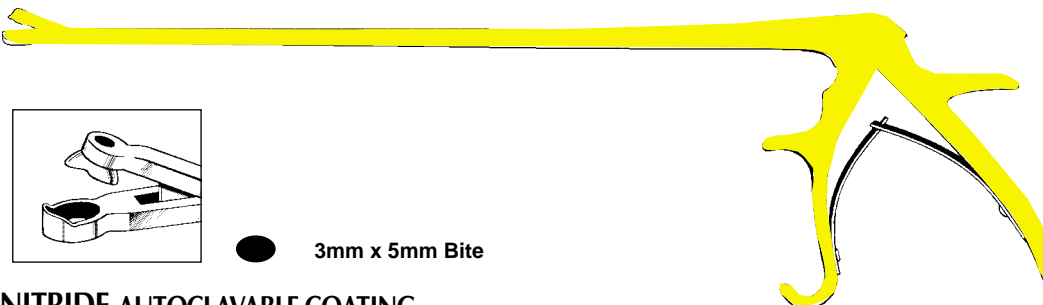
WIDE BITE SKLAR OVAL BIOPSY PUNCH

90-9565

3mm x 5mm Bite

Opens to 60° for easy removal of biopsy and safer cleaning

NEW!



TITANIUM NITRIDE-AUTOCLAVABLE COATING

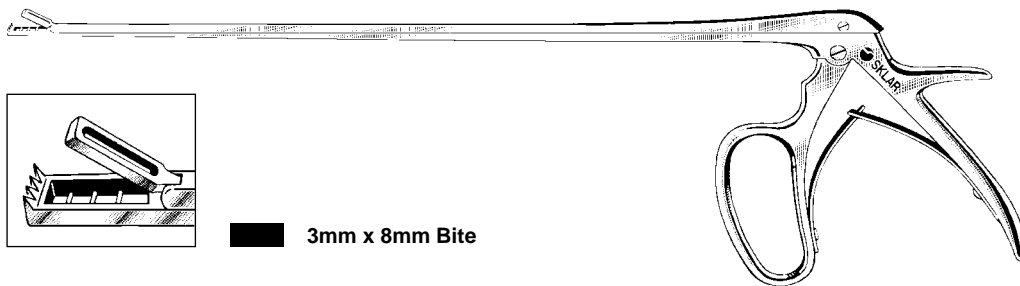
SKLAR OVAL BIOPSY PUNCH

25-9020

3mm x 5mm Bite

- Superior corrosion resistance
- Saves money-increased wear resistance results in extended life of the instrument
- Hardest possible ceramic coating provides the ultimate cutting edge

NEW!

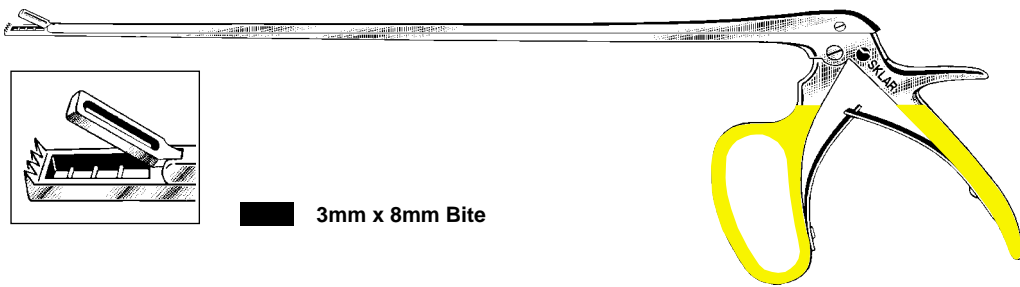


SKLAR KEVORKIAN BIOPSY PUNCH

90-7540

3mm x 8mm Bite

NEW!

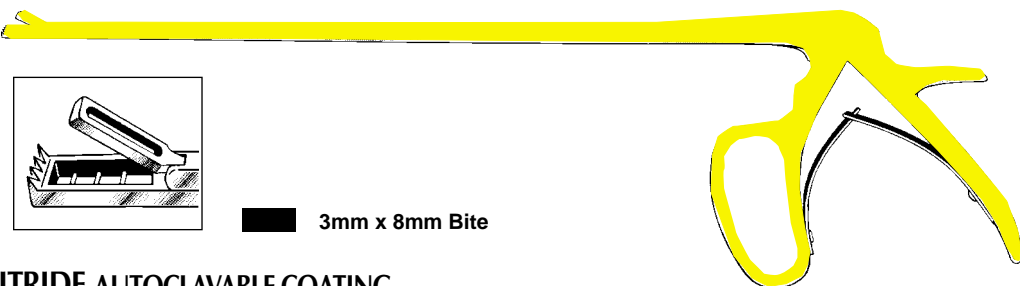


MICRO-CUT SKLAR KEVORKIAN BIOPSY PUNCH

90-8952

3mm x 8mm Bite

NEW!



TITANIUM NITRIDE-AUTOCLAVABLE COATING

SKLAR KEVORKIAN BIOPSY PUNCH

25-9025

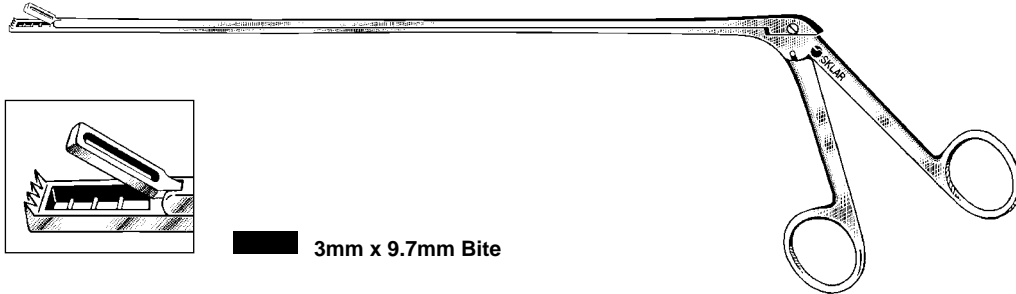
3mm x 8mm Bite

- Superior corrosion resistance
- Saves money-increased wear resistance results in extended life of the instrument
- Hardest possible ceramic coating provides the ultimate cutting edge

GYNECOLOGY BIOPSY FORCEPS



NEW!

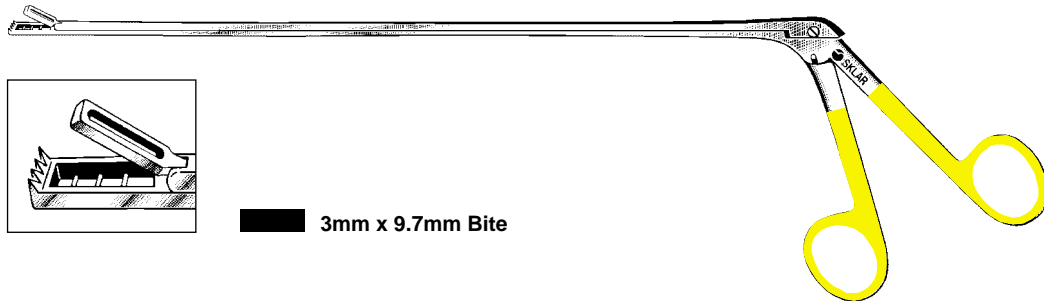


3mm x 9.7mm Bite

KEVORKIAN-YOUNGE BIOPSY PUNCH

90-6610 Teeth on lower jaw 3mm x 9.7mm Bite

NEW!



3mm x 9.7mm Bite

MICRO-CUT KEVORKIAN-YOUNGE BIOPSY PUNCH

90-8905 Teeth on lower jaw 3mm x 9.7mm Bite

NEW!



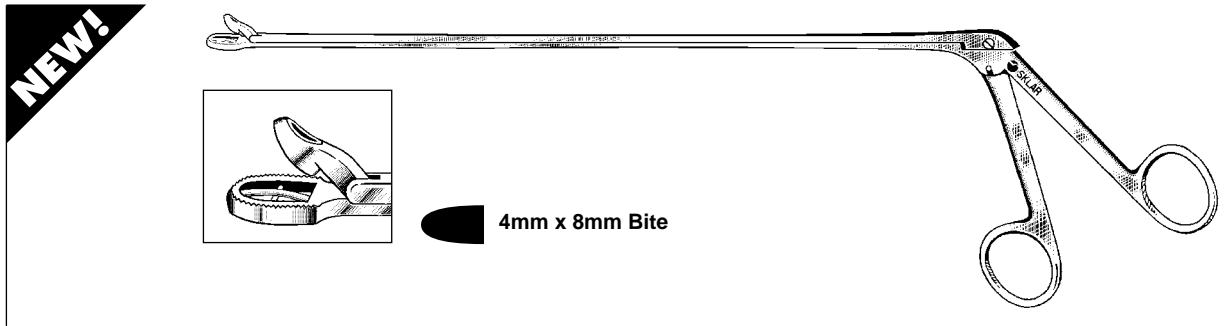
3mm x 9.7mm Bite

TITANIUM NITRIDE-AUTOCLAVABLE COATING

KEVORKIAN-YOUNGE BIOPSY PUNCH

25-9030 Teeth on lower jaw 3mm x 9.7mm Bite

- Superior corrosion resistance
- Saves money-increased wear resistance results in extended life of the instrument
- Hardest possible ceramic coating provides the ultimate cutting edge

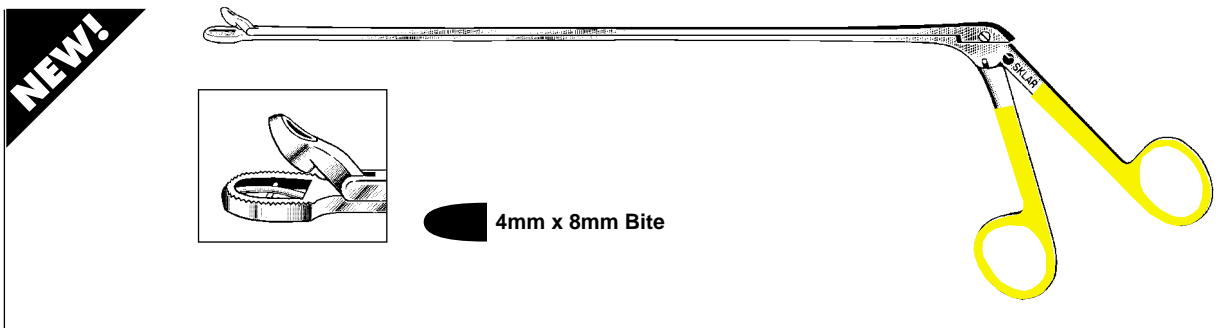


EPPENDORFER BIOPSY PUNCH

90-6820

4mm x 8mm Bite

Improved jaws

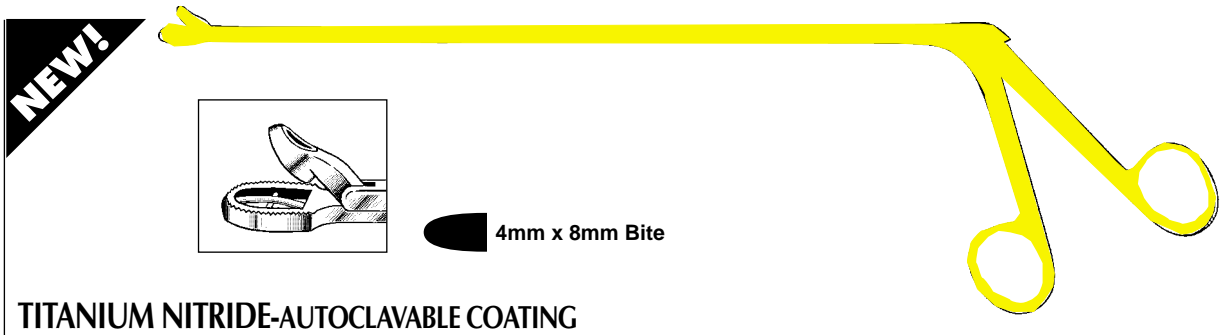


MICRO-CUT EPPENDORFER BIOPSY PUNCH

90-8010

4mm x 8mm Bite

Improved jaws



TITANIUM NITRIDE-AUTOCLAVABLE COATING

EPPENDORFER BIOPSY PUNCH

25-9035

4mm x 8mm Bite

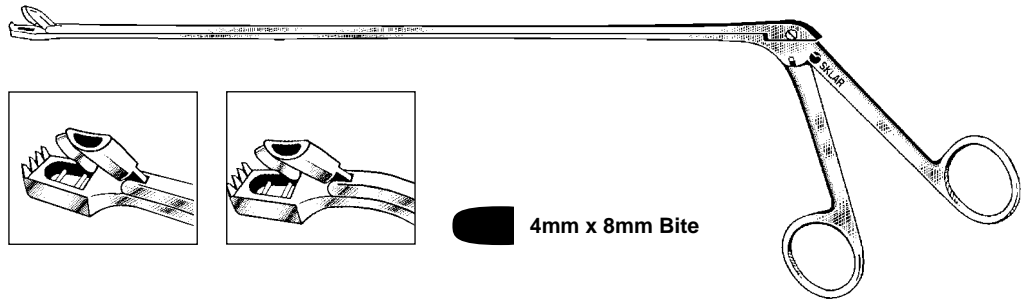
Improved jaws

- Superior corrosion resistance
- Saves money-increased wear resistance results in extended life of the instrument
- Hardest possible ceramic coating provides the ultimate cutting edge

GYNECOLOGY BIOPSY FORCEPS

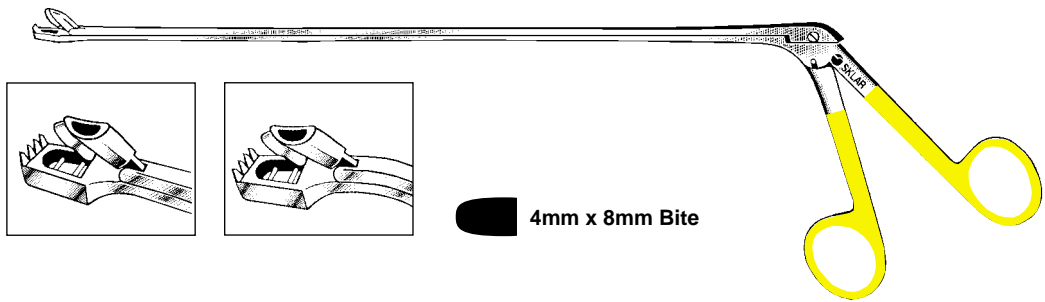


NEW!



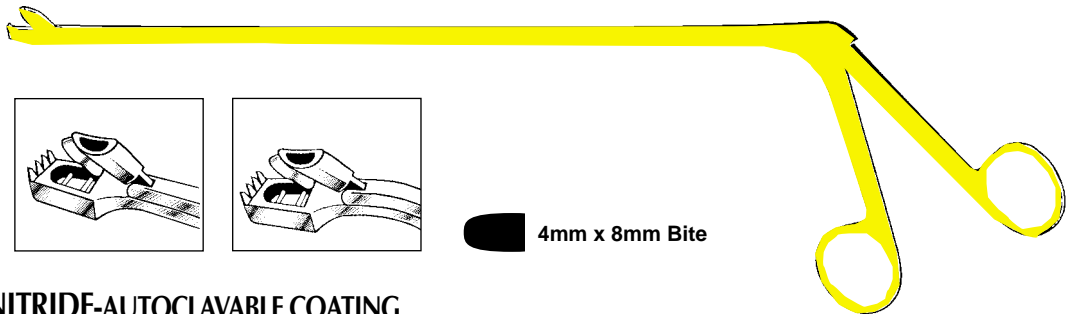
WITTNER UTERINE BIOPSY PUNCH 90-6600 Straight 90-6602 Angular

NEW!



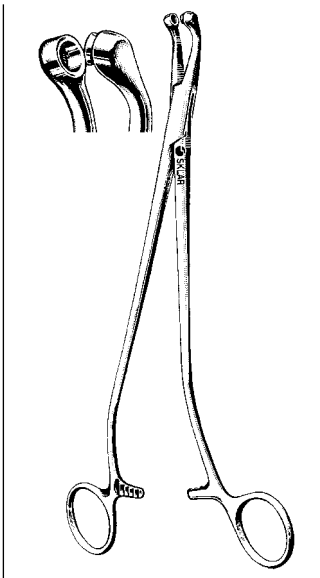
MICRO-CUT WITTNER UTERINE BIOPSY PUNCH 90-8900 Straight 90-8902 Angular

NEW!



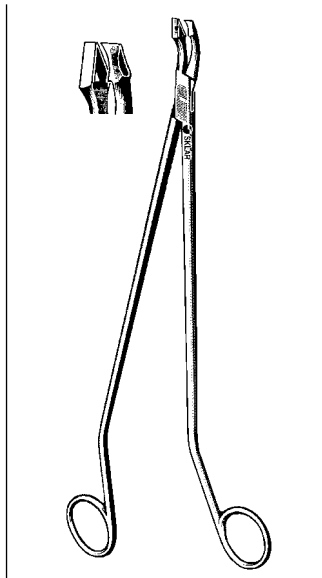
TITANIUM NITRIDE-AUTOCLAVABLE COATING
WITTNER UTERINE BIOPSY PUNCH 25-9040 Straight 25-9042 Angular

- Superior corrosion resistance
- Saves money-increased wear resistance results in extended life of the instrument
- Hardest possible ceramic coating provides the ultimate cutting edge



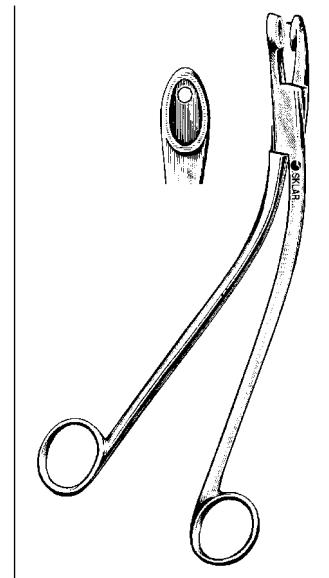
GAYLOR BIOPSY PUNCH

Improved Jaws 90-7385 8½"
Micro-Cut 90-8925 8½"



SCHUBERT-VAN DOREN BIOPSY PUNCH

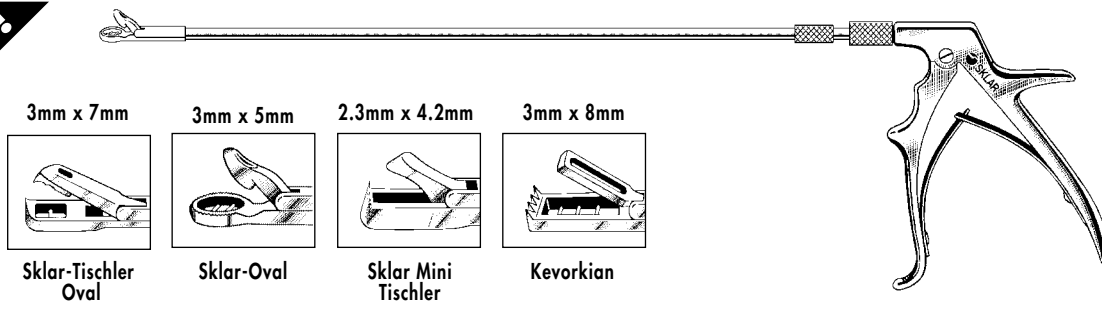
90-7511
10" Angular Tip and Shanks



GELHORN BIOPSY PUNCH

90-7492 9½"
90-8930 9½" Micro-Cut

NEW!



UNIVERSAL STYLE BIOPSY INSTRUMENTS

Complete Instrument

90-7551 Sklar-Tischler Oval
90-7552 Sklar-Oval
90-7553 Sklar Mini Tischler
90-7554 Kevorkian
90-7560 Universal Handle

Cannula W/Tip Only

90-7555 Sklar-Tischler Oval
90-7556 Sklar-Oval
90-7557 Sklar Mini Tischler
90-7558 Kevorkian

MICRO-CUT UNIVERSAL STYLE BIOPSY INSTRUMENTS

Complete Instrument

90-8960 Sklar-Tischler Oval
90-8962 Sklar-Oval
90-8964 Sklar Mini Tischler
90-8966 Kevorkian
90-8980 Universal Gold Handle

Cannula W/Tip Only

90-8970 Sklar-Tischler Oval
90-8972 Sklar-Oval
90-8974 Sklar Mini Tischler
90-8976 Kevorkian



Sklar Blue Electrosurgery Instrumentation

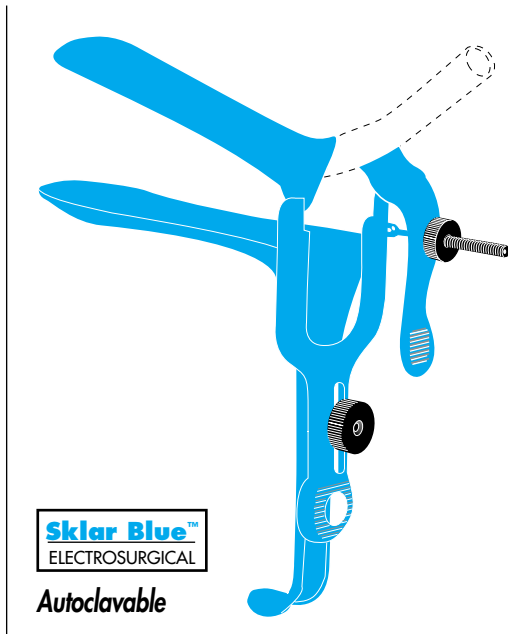
Sklar's new line of electrosurgical instruments features our exclusive Sklar Blue™ coating. Manufactured of the highest quality stainless steel, these instruments are fully autoclavable, and can even be cleaned ultrasonically.

These instruments are designed to provide an effective patient-safe surface that prevents transmission of RF current through the instrument.

All Sklar Blue™ electrosurgery coatings are guaranteed one year against manufacturing defects.

Sklar Blue™
ELECTROSURGICAL

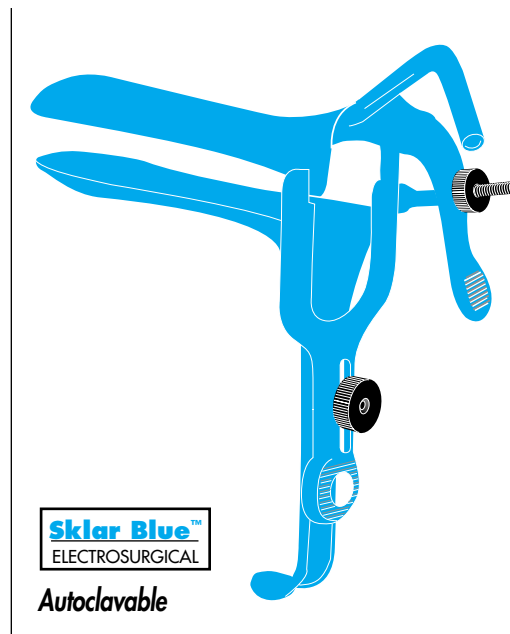
Sklar Exclusive!



**SKLAR BLUE™ GRAVES
VAGINAL SPECULUM**

With slip rings for disposable smoke evacuation tube

91-5010	3"x3/4"	Small
91-5012	4"x1 1/4"	Medium
91-5014	4 1/2"x 1 3/8"	Large
91-5018	4 3/4" x 1 1/2"	Extra Large



**SKLAR BLUE™ GRAVES
VAGINAL SPECULUM**

With permanent smoke evacuation tube

91-5020	3"x3/4"	Small
91-5022	4"x1 1/4"	Medium
91-5024	4 1/2"x 1 3/8"	Large
91-5028	4 3/4" x 1 1/2"	Extra Large

Sklar Blue Electrosurgery Instrumentation

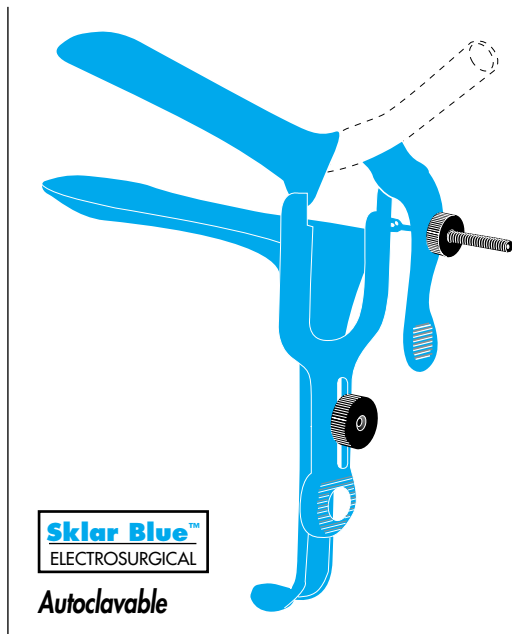
Sklar's new line of electrosurgical instruments features our exclusive Sklar Blue™ coating. Manufactured of the highest quality stainless steel, these instruments are fully autoclavable, and can even be cleaned ultrasonically.

These instruments are designed to provide an effective patient-safe surface that prevents transmission of RF current through the instrument.

All Sklar Blue™ electrosurgery coatings are guaranteed one year against manufacturing defects.



Sklar Exclusive!



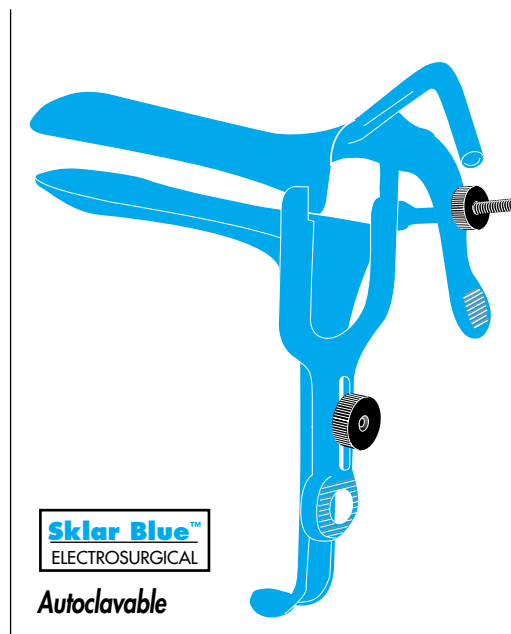
Sklar Blue™
ELECTROSURGICAL

Autoclavable

SKLAR BLUE™ PEDERSON VAGINAL SPECULUM

With slip rings for disposable smoke evacuation tube

91-5032	3" x 1/2"	Small
91-5034	4" x 7/8"	Medium
91-5036	4 3/4" x 1"	Large
91-5040	4" x 5/8"	Slender



Sklar Blue™
ELECTROSURGICAL

Autoclavable

SKLAR BLUE™ PEDERSON VAGINAL SPECULUM

With permanent smoke evacuation tube

91-5042	3" x 1/2"	Small
91-5044	4" x 7/8"	Medium
91-5046	4 3/4" x 1"	Large
91-5050	4" x 5/8"	Slender

GYNECOLOGY ELECTROSURGICAL INSTRUMENTS



SKLAR BLUE™ GRAVES VAGINAL SPECULUM

Without Tube or Ring

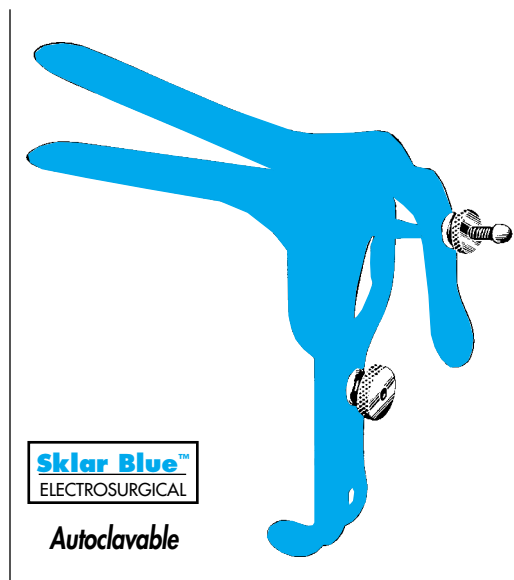
- 91-5060 3" x 3/4" Small
- 91-5062 4" x 1 1/4" Medium
- 91-5064 4 1/2" x 1 3/8" Large



SKLAR BLUE™ GRAVES VAGINAL SPECULUM

Without Tube or Ring

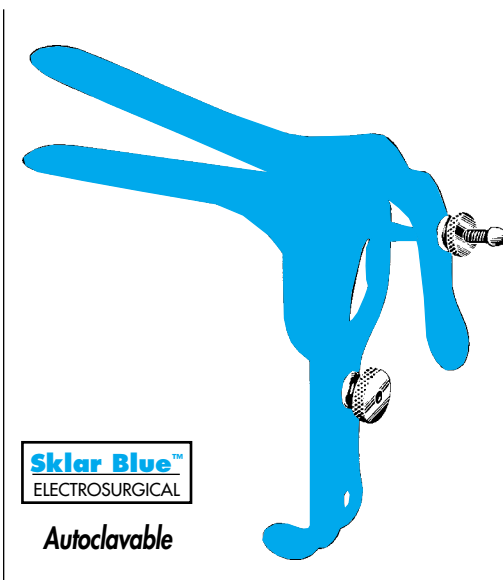
- 91-5066 3" x 1/2" Extra Small
- 91-5068 4 3/4" x 1 1/2" Extra Large



SKLAR BLUE™ PEDERSON VAGINAL SPECULUM

Without Tube or Ring

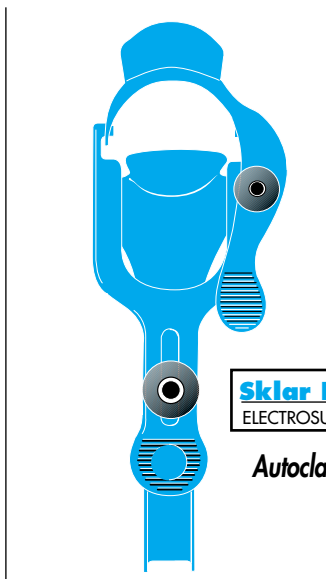
- 91-5082 3" x 1/2" Small
- 91-5084 4" x 7/8" Medium
- 91-5086 4 3/4" x 1" Large



SKLAR BLUE™ PEDERSON VAGINAL SPECULUM

Without Tube or Ring

- 91-5088 2 3/4" x 5/8" Extra Small
- 91-5092 4" x 5/8" Slender



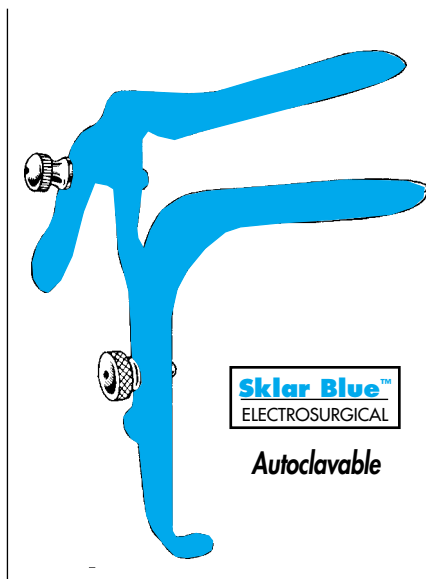
Sklar Blue™
ELECTROSURGICAL

Autoclavable

SKLAR BLUE™ GRAVES VAGINAL SPECULUM WIDE VIEW PATTERN

With large proximal opening for instrumentation

91-5080 4" x 1 1/4" Medium, With loops for holding and directing Smoke Evacuation Tubing

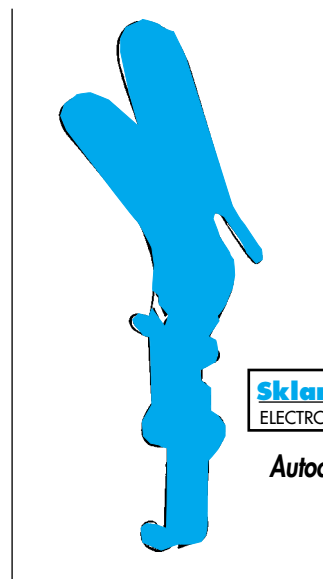


Sklar Blue™
ELECTROSURGICAL

Autoclavable

SKLAR BLUE™ FREEWAY GRAVES VAGINAL SPECULUM

Open Side 90° Angle
91-5160 4" x 1 1/4"

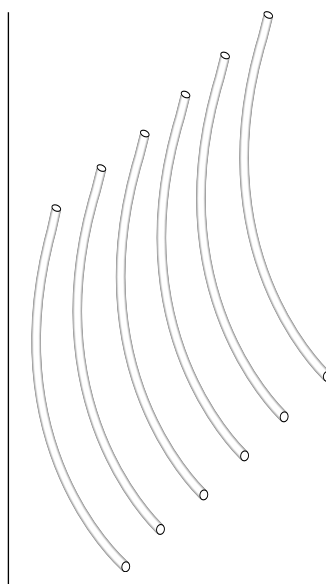


Sklar Blue™
ELECTROSURGICAL

Autoclavable

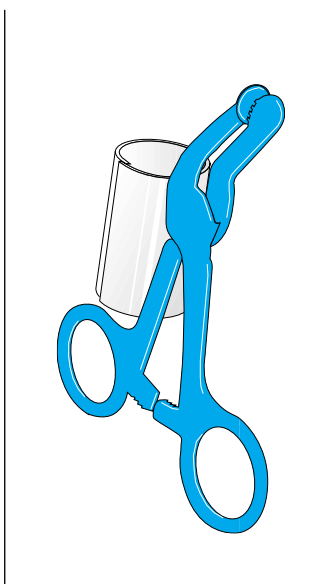
SKLAR BLUE™ FREEWAY VAGINAL SPECULUM

Open Side
91-5162 45° Angle



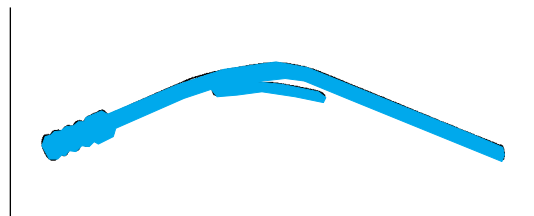
DISPOSABLE SMOKE EVACUATION TUBING

93-2160 Case of 50 in 10" precut lengths—7/8" x 10"



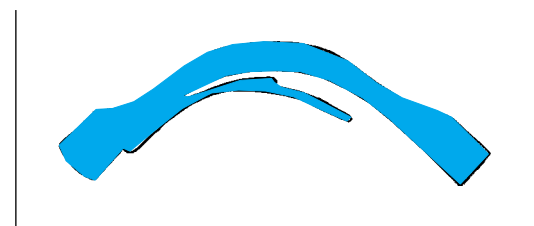
SKLAR BLUE™ WAND CLAMP

93-2165 Blue Nylon Glass Wand Clamp to hold 1/4" smoke evacuation tubing



SKLAR BLUE™ SMOKE EVACUATION TUBE

91-5110 Clip-on



SKLAR BLUE™ SMOKE EVACUATION TUBE HOLDER

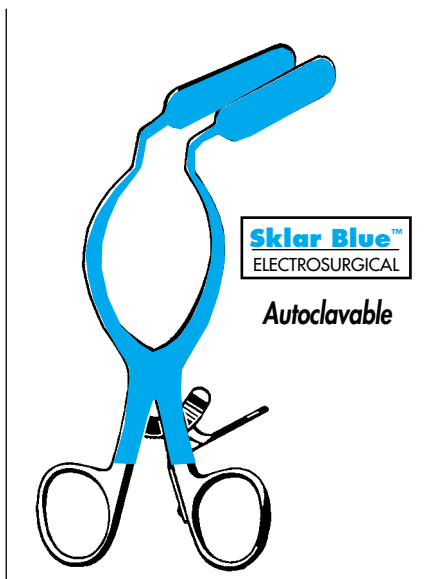
Holds disposable tubing to top of speculum
91-5112

GYNECOLOGY ELECTROSURGICAL INSTRUMENTS



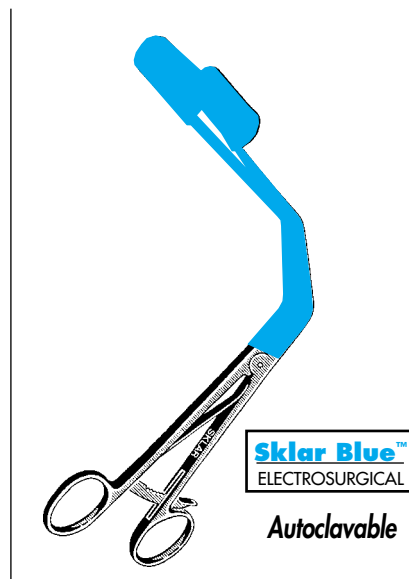
SKLAR BLUE™ CUSCO VAGINAL SPECULUM

91-5150 3" x 1 1/4" Small
 91-5152 3 1/3" x 1 1/3" Medium
 91-5154 3 3/4" x 1 3/8" Large



SKLAR BLUE™ McGEE LATERAL VAGINAL RETRACTOR

With True Grip Ratchet
 Fits Outside Vaginal Speculum
 91-5188



SKLAR BLUE™ LATERAL VAGINAL RETRACTOR

Ratchet Handle
 Fits Inside Vaginal Speculum
 91-5190



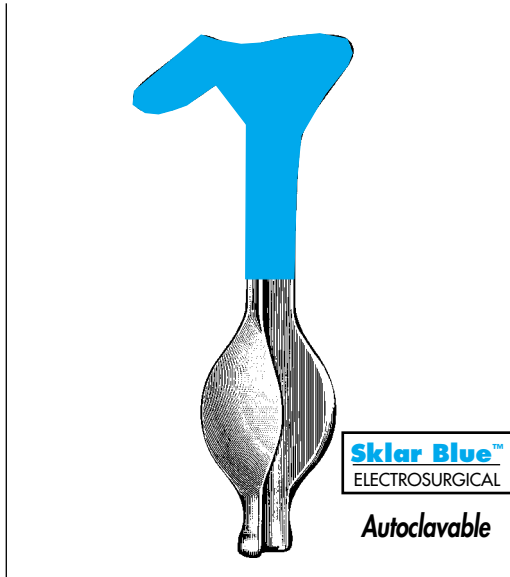
SKLAR BLUE™ VAGINAL SPATULA

Blade 3 1/2" x 1 3/8"
 91-5176 9 1/4" Tauber
 Blade 4 3/4" x 1 3/8"
 91-5178 10 1/2" Segund



SKLAR BLUE™ COLLIN VAGINAL SPECULUM

91-5180 4 1/4" x 1 1/4" Blades
 With permanent smoke tube
 91-5185 4 1/4" x 1 1/4" Blades
 With loops

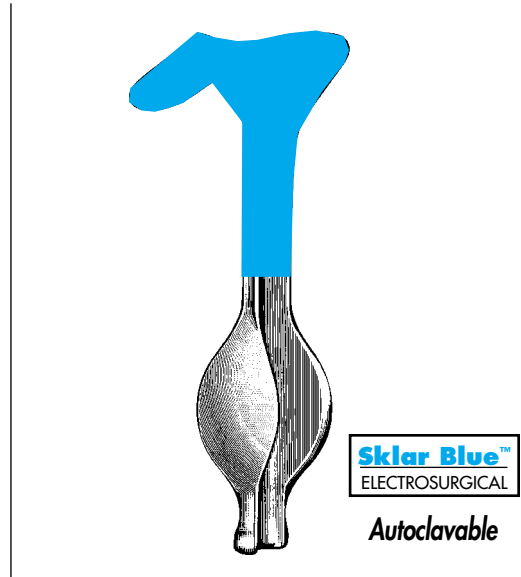


SKLAR BLUE™ AUVARD VAGINAL SPECULUM

Blades 2³/₄" x 1¹/₂"

91-5120 Medium 2¹/₂ lbs.

91-5122 Medium 2¹/₂ lbs., with loop to hold and direct disposable evacuation tubing.



SKLAR BLUE™ AUVARD VAGINAL SPECULUM

Extra Long Blades 4" x 1³/₄"

91-5130 Medium 2¹/₂ lbs.

91-5132 Medium 2¹/₂ lbs., with loop to hold and direct disposable evacuation tubing.

Sklar Blue™ Electrosurgery Instruments

- Prevents Transmission of RF Current
- Non-Conductive
- Ultrasonically Cleanable
- Autoclavable
- One Year Guarantee Against Manufacturing Defects



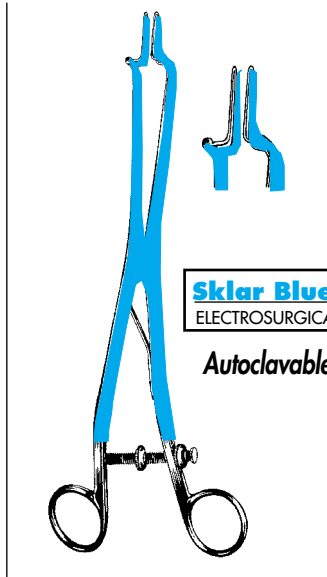
SKLAR BLUE™ STEINER-AUVARD VAGINAL SPECULUM

Blades 5¹/₂" x 1¹/₄"

91-5140 2¹/₂ lbs.

91-5142 2¹/₂ lbs. With loop to hold and direct disposable evacuation tubing.

GYNECOLOGY ELECTROSURGICAL INSTRUMENTS

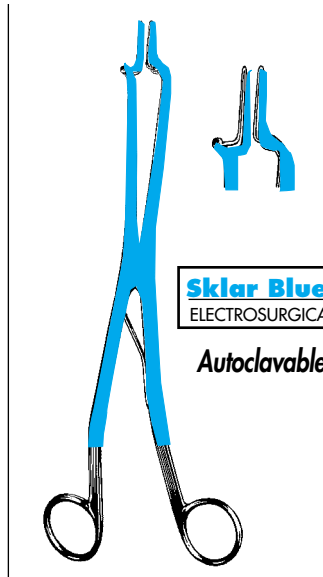


Sklar Blue™
ELECTROSURGICAL

Autoclavable

SKLAR BLUE™ KOGAN ENDOSPECULUM

With Gauge and Screws
91-5230 Narrow Wire Blades

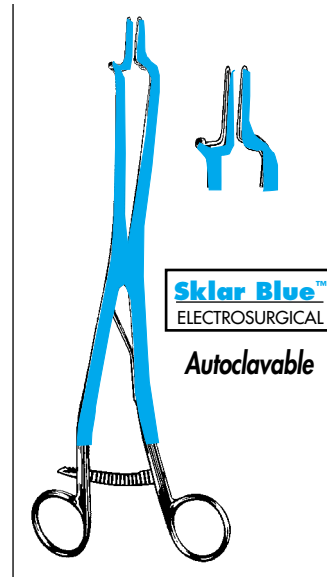


Sklar Blue™
ELECTROSURGICAL

Autoclavable

SKLAR BLUE™ KOGAN ENDOSPECULUM

With Spring
91-5228 Narrow Wire Blades

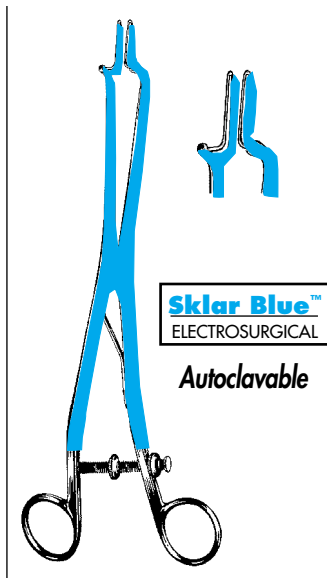


Sklar Blue™
ELECTROSURGICAL

Autoclavable

SKLAR BLUE™ KOGAN ENDOSPECULUM

With Ratchet
91-5235 Narrow Wire Blades

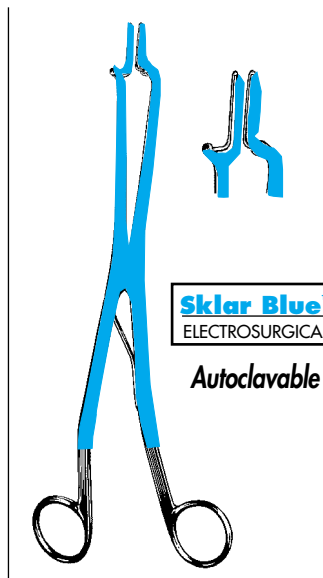


Sklar Blue™
ELECTROSURGICAL

Autoclavable

SKLAR BLUE™ KOGAN ENDOSPECULUM

With Gauge and Screws
91-5232 Wide Wire Blades

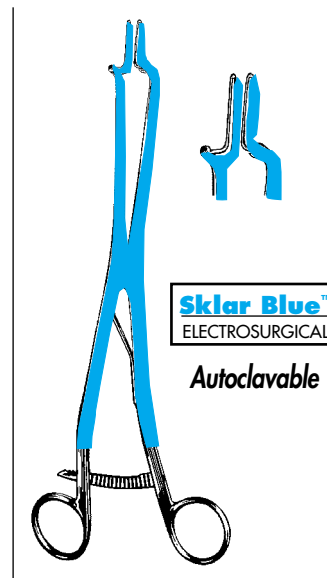


Sklar Blue™
ELECTROSURGICAL

Autoclavable

SKLAR BLUE™ KOGAN ENDOSPECULUM

With Spring
91-5226 Wide Wire Blades



Sklar Blue™
ELECTROSURGICAL

Autoclavable

SKLAR BLUE™ KOGAN ENDOSPECULUM

With Ratchet
91-5234 Wide Wire Blades



SKLAR BLUE™ SIMS RETRACTOR

Single End

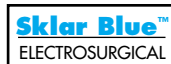
- 91-5200 Medium
- 91-5202 Medium, With loop to hold and direct disposable smoke evacuation tubing.



SKLAR BLUE™ SIMS RETRACTOR

Double End

- 91-5210 Medium
- 91-5212 Medium, With loop to hold and direct disposable smoke evacuation tubing.



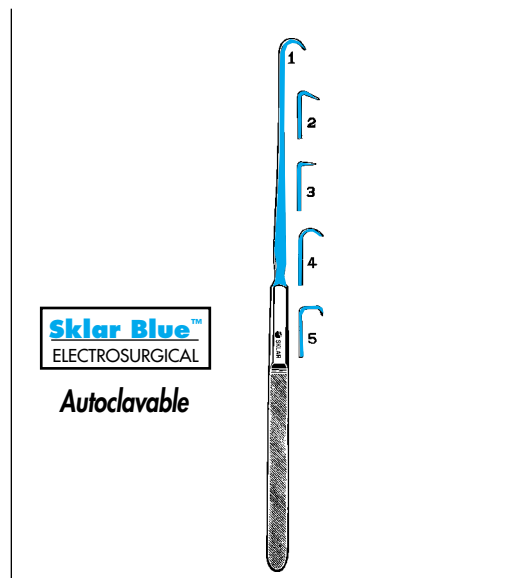
Autoclavable



SKLAR BLUE™ JACKSON VAGINAL RETRACTOR

Single End

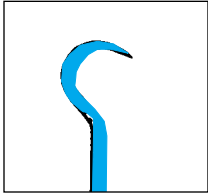
- 91-5215 Small
 - 91-5218 Medium
 - 91-5220 Large
 - 91-5222 Small
 - 91-5224 Medium
 - 91-5225 Large
- With loop to hold and direct disposable smoke evacuation tubing.



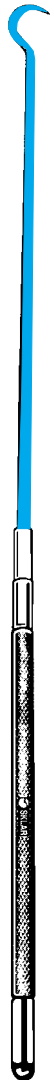
SKLAR BLUE™ EMMETT HOOKS

- 91-5251 Style 1
- 91-5252 Style 2
- 91-5253 Style 3
- 91-5254 Style 4
- 91-5255 Style 5
- 91-5250 Set of 5

GYNECOLOGY ELECTROSURGICAL INSTRUMENTS

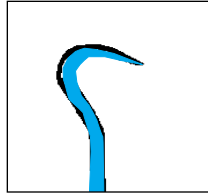


Emmett:
6mm Diameter

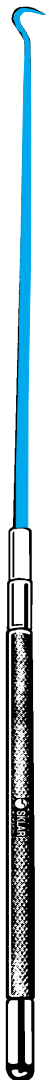


Sklar Blue™
ELECTROSURGICAL

Autoclavable

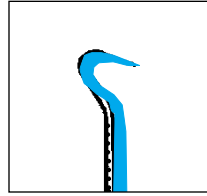


Mini Emmett:
4mm Diameter

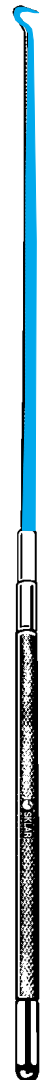


Sklar Blue™
ELECTROSURGICAL

Autoclavable

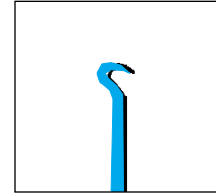


Maxi Iris:
3mm Diameter



Sklar Blue™
ELECTROSURGICAL

Autoclavable



Iris:
1mm Diameter



Sklar Blue™
ELECTROSURGICAL

Autoclavable

SKLAR BLUE™ EMMETT HOOK

91-5241 9" Quick Release
91-5245 12" Quick Release

SKLAR BLUE™ MINI EMMETT HOOK

91-5242 9" Quick Release
91-5246 12" Quick Release

SKLAR BLUE™ MAXI IRIS HOOK

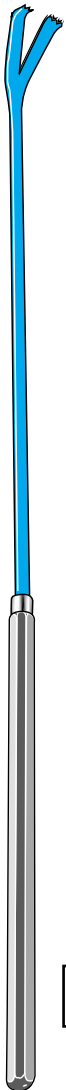
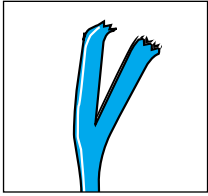
91-5243 9" Quick Release
91-5247 12" Quick Release

SKLAR BLUE™ IRIS HOOK

91-5244 9" Quick Release
91-5248 12" Quick Release

Set of All 4-Tissue Hooks

91-5236 9" Quick Release
91-5238 12" Quick Release

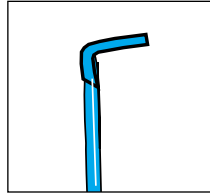


Sklar Blue™
ELECTROSURGICAL

Autoclavable

**SKLAR BLUE™ CERVICAL
MANIPULATOR**

91-5240 With micro serrations to
prevent slippage

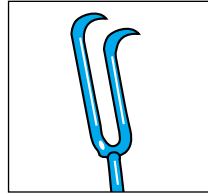


Sklar Blue™
ELECTROSURGICAL

Autoclavable

**SKLAR BLUE™ OFFSET
HOOK**

For Position Tissue
91-5258 3/8" 85° Angle

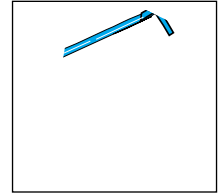


Sklar Blue™
ELECTROSURGICAL

Autoclavable

**SKLAR BLUE™ CERVICAL
HOOK**

91-5260 Double sharp hooks offset
20 degrees



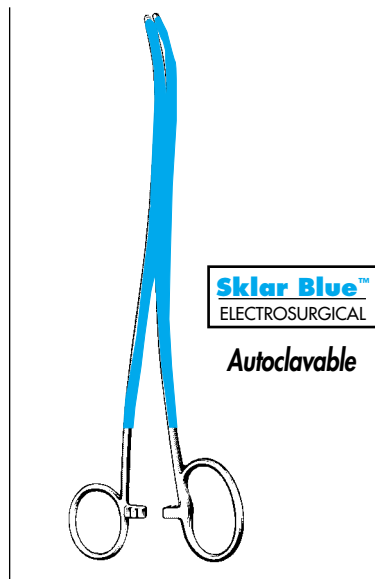
Sklar Blue™
ELECTROSURGICAL

Autoclavable

**SKLAR BLUE™ CERVICAL
HOOK**

91-5264 Three Sharp Prongs

GYNECOLOGY ELECTROSURGICAL INSTRUMENTS

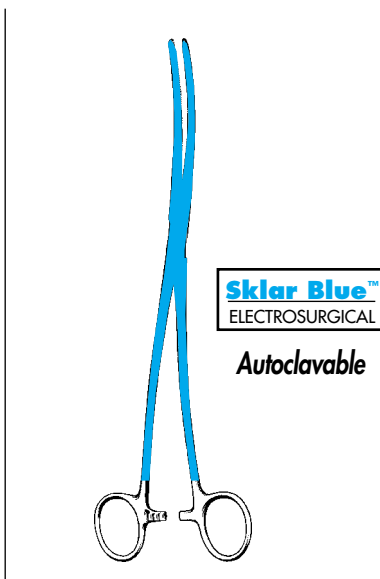


Sklar Blue™
ELECTROSURGICAL

Autoclavable

SKLAR BLUE™ BOZEMAN FORCEPS

One Large Ring
91-5310 10¼" Curved

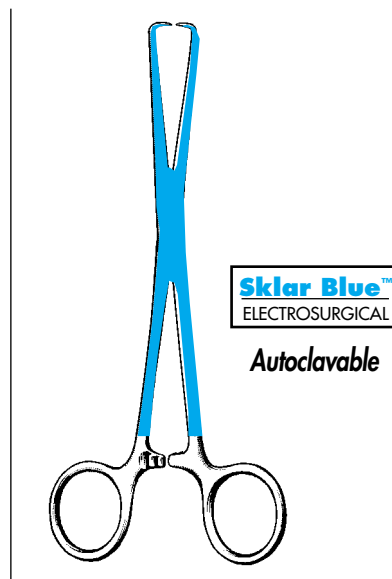


Sklar Blue™
ELECTROSURGICAL

Autoclavable

SKLAR BLUE™ BOZEMAN FORCEPS

91-5307 10½" Straight
91-5308 10¼" Double Curve

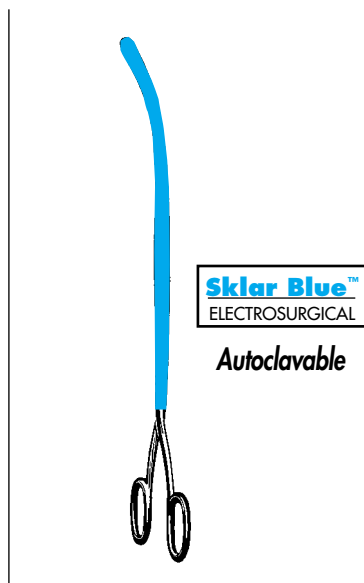


Sklar Blue™
ELECTROSURGICAL

Autoclavable

SKLAR BLUE™ SCHROEDER TENACULUM FORCEPS

91-5450 9¼"
91-5452 10" Pozzi
91-5455 10¼" Braun

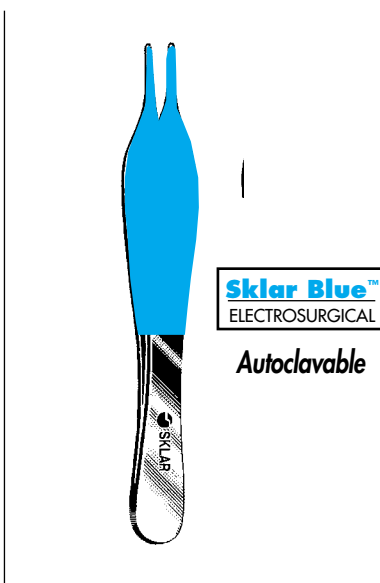


Sklar Blue™
ELECTROSURGICAL

Autoclavable

SKLAR BLUE™ CAMPION GRASPING FORCEPS

91-5410 9¼" Curved



Sklar Blue™
ELECTROSURGICAL

Autoclavable

SKLAR BLUE™ ADSON FORCEPS

91-5428 4¾" Serrated

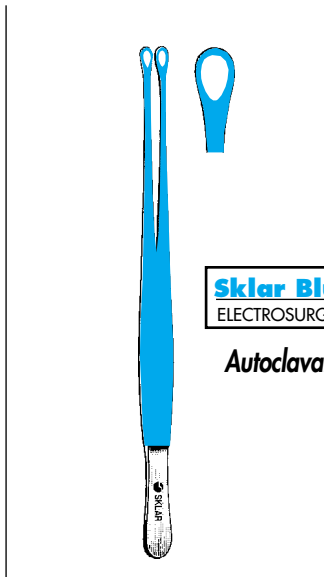


Sklar Blue™
ELECTROSURGICAL

Autoclavable

SKLAR BLUE™ POTTS-SMITH FORCEPS

91-5411 7" Serrated

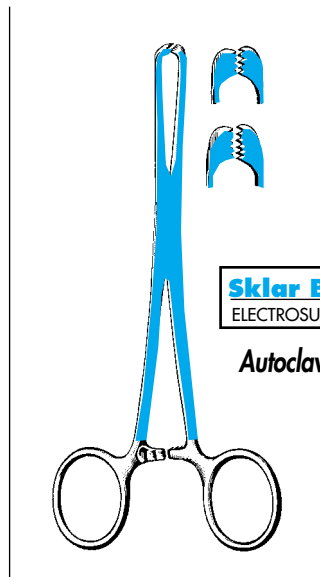


Sklar Blue™
ELECTROSURGICAL

Autoclavable

SKLAR BLUE™ TUTTLE/SINGLEY FORCEPS

91-5300 7" Tuttle
91-5302 9" Singley

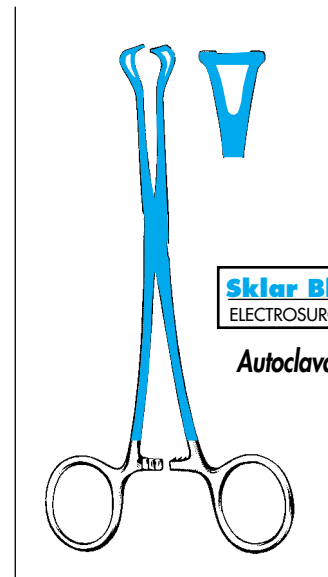


Sklar Blue™
ELECTROSURGICAL

Autoclavable

ALLIS TISSUE FORCEPS

91-5274 5" 4 x 5 Teeth
91-5278 7½" 5 x 6 Teeth
91-5440 10" 5 x 6 Teeth

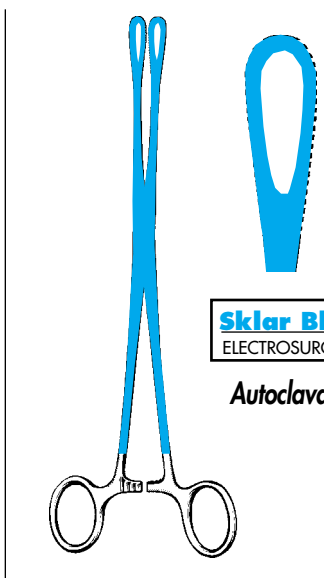


Sklar Blue™
ELECTROSURGICAL

Autoclavable

SKLAR BLUE™ FORCEPS

91-5268 8" Babcock
91-5270 9½" Babcock

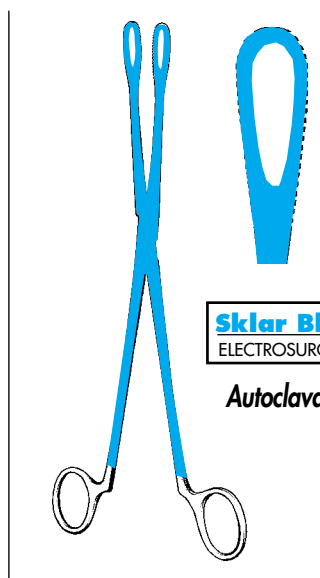


Sklar Blue™
ELECTROSURGICAL

Autoclavable

SKLAR BLUE™ SCHWEIZER FORCEPS

91-5404 9½" Straight

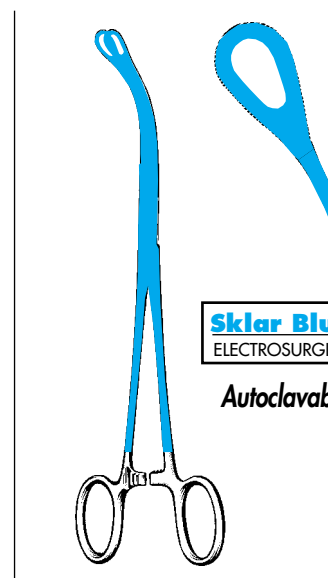


Sklar Blue™
ELECTROSURGICAL

Autoclavable

SKLAR BLUE™ CLEMETSON FORCEPS

91-5400 9½" Straight
No Ratchet



Sklar Blue™
ELECTROSURGICAL

Autoclavable

SKLAR BLUE™ LAUFE UTERINE POLYP FORCEPS

91-5408 7¾" Curved



Gynecology Laser Instrumentation

Sandblasted vs Coated Instruments

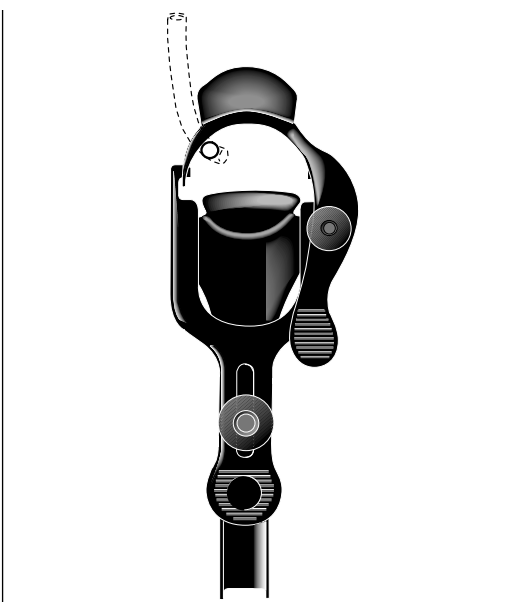
Testing demonstrated that the Sklar black coating over a roughened surface reduced reflected laser energy to less than one-tenth of one percent!

Sklar uses an improved black polymer coating developed specifically for Laser surgery. The coating is durable and safe, resulting in an instrument you can use with confidence and rely on for years of service.

All Sklar Laser coatings are guaranteed one year against manufacturing defects.



Sklar Exclusive!



LASER GRAVES VAGINAL SPECULUM

With slip rings for smoke evacuation tubing

90-9000	3" x 3/4"	Small
90-9002	4" x 3 1/4"	Medium
90-9004	4 1/2" x 1 3/8"	Large
90-9005	3" x 3/4"	Extra Small



LASER GRAVES VAGINAL SPECULUM

With permanent smoke evacuation tubing

90-9015	3" x 3/4"	Small
90-9016	4" x 3 1/4"	Medium
90-9018	4 1/2" x 1 3/8"	Large
90-9020	4 3/4" x 1 1/2"	Extra Large

Gynecology Laser Instrumentation

Sandblasted vs Coated Instruments

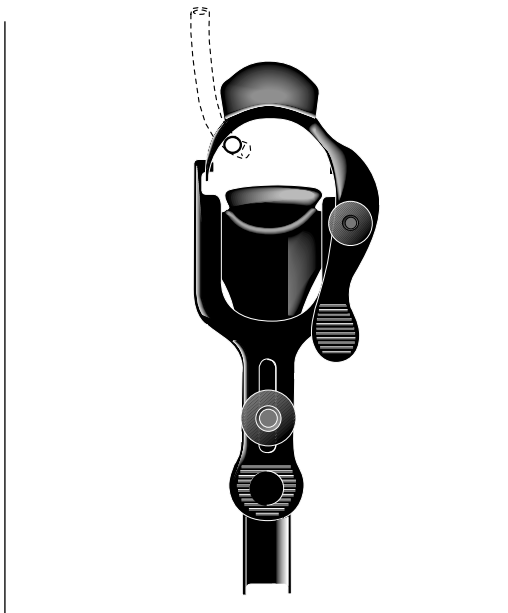
Testing demonstrated that the Sklar black coating over a roughened surface reduced reflected laser energy to less than one-tenth of one percent!

Sklar uses an improved black polymer coating developed specifically for Laser surgery. The coating is durable and safe, resulting in an instrument you can use with confidence and rely on for years of service.

All Sklar Laser coatings are guaranteed one year against manufacturing defects.



Sklar Exclusive!



LASER PEDERSON VAGINAL SPECULUM

With slip rings for smoke evacuation tubing

90-9030	3" x 1/2"	Small
90-9032	4" x 7/8"	Medium
90-9034	4 3/4" x 1"	Large
90-9035	2 3/4" x 5/8"	Extra Small
90-9038	4" x 5/8"	Slender



LASER PEDERSON VAGINAL SPECULUM

With permanent smoke evacuation tubing

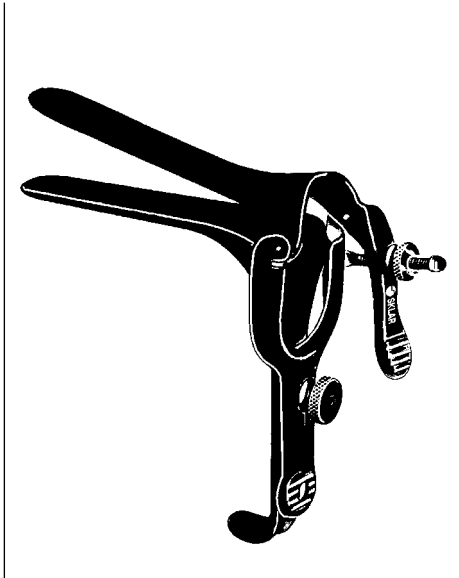
90-9040	3" x 1/2"	Small
90-9042	4" x 7/8"	Medium
90-9044	4 3/4" x 1"	Large
90-9046	2 3/4" x 5/8"	Extra Small
90-9048	4 3/4" x 1 5/8"	Extra Large
90-9050	4" x 5/8"	Slender

GYNECOLOGY LASER INSTRUMENTS



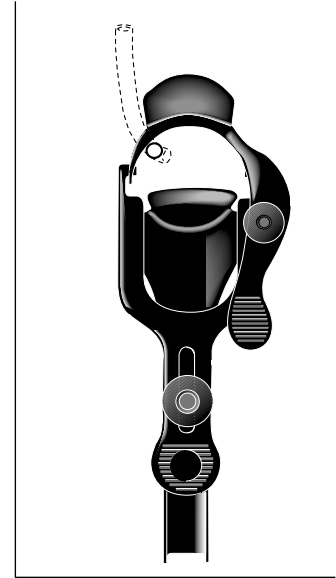
LASER GRAVES VAGINAL SPECULUM

90-3804	3" x 3/4"	Small
90-3806	4" x 1 1/4"	Medium
90-3808	4 1/2" x 1 3/8"	Large
90-3812	3" x 1/2"	Extra Small
90-3810	4 3/4" x 1 1/2"	Extra Large



LASER PEDERSON VAGINAL SPECULUM

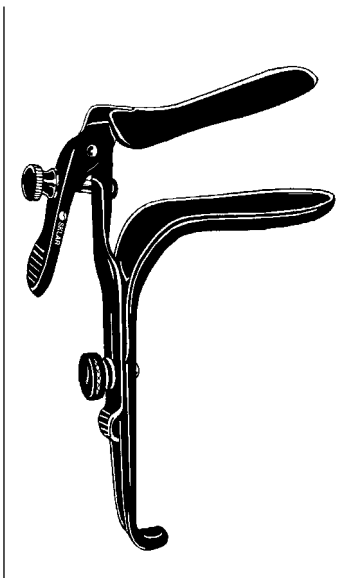
90-3833	3" x 1/2"	Small
90-3835	4 3/4" x 1"	Large
90-3837	4" x 5/8"	Slender
90-3839	4" x 7/8"	Medium
90-3841	2 3/4" x 5/8"	Extra Small



LASER GRAVES WIDE VIEW VAGINAL SPECULUM

Wide proximal opening for instrumentation

90-9055 Medium 4" x 1 1/4"
With loop to hold and direct disposable smoke evacuation tubing

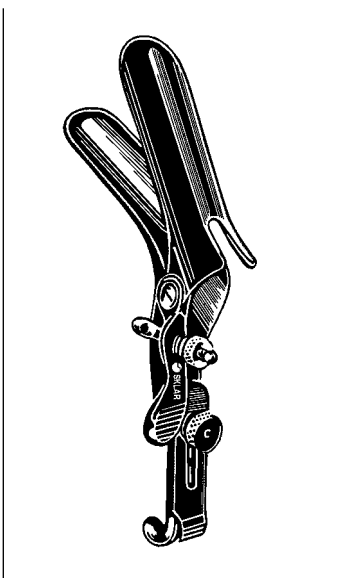


LASER FREEWAY GRAVES VAGINAL SPECULUM

Open Side

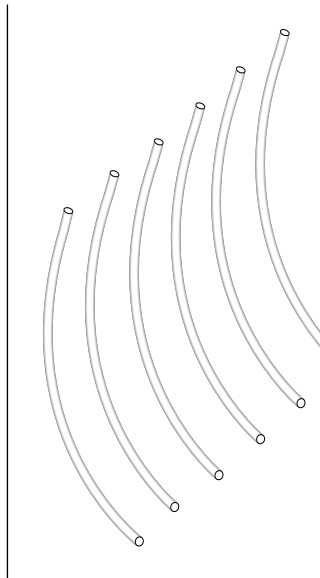
90-3754	4" x 1 1/4"
	Without loop
90-3755	4" x 1 1/4"

With loop to hold and direct disposable smoke evacuation tubing



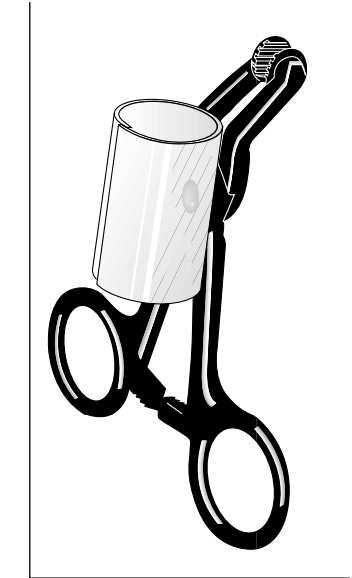
LASER FREEWAY GRAVES VAGINAL SPECULUM

90-3815 45° Angle
Medium



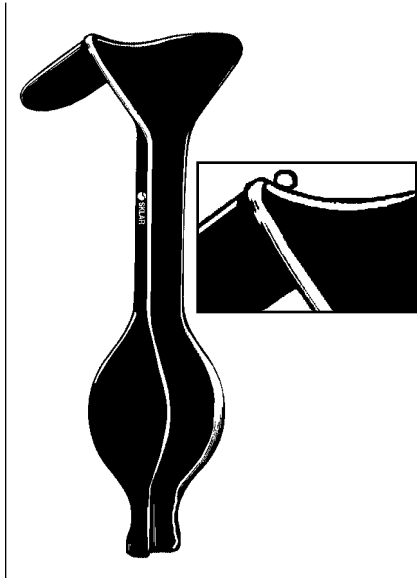
DISPOSABLE SMOKE EVACUATION TUBING

93-2160 Case of 50 in 10" precut
3/8" ID 1/4" OD



LASER WAND CLAMP

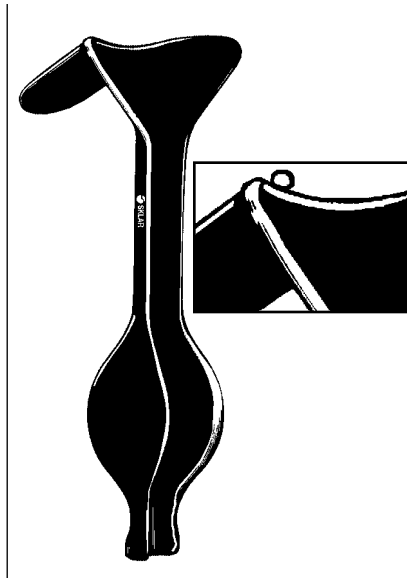
93-2165 Blue Nylon Glass Wand Clamp to hold 1/4" smoke evacuation tubing



**LASER AUVARD
VAGINAL SPECULUM**

Blades 2¾" x 1½"

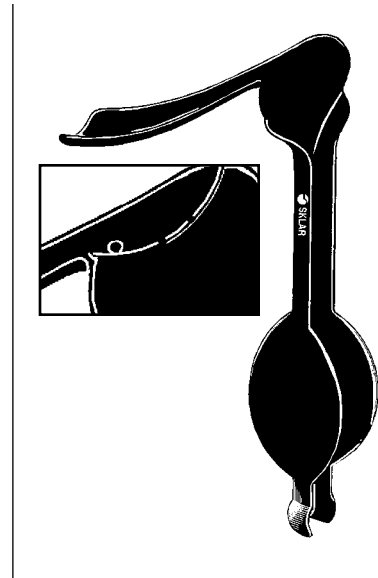
- 90-9100 Medium 2½ lbs. Without loop
- 90-9102 Medium 2½ lbs., With loop to hold and direct disposable evacuation tubing.



**LASER AUVARD
VAGINAL SPECULUM**

Extra Long Blades 4" x 1¾"

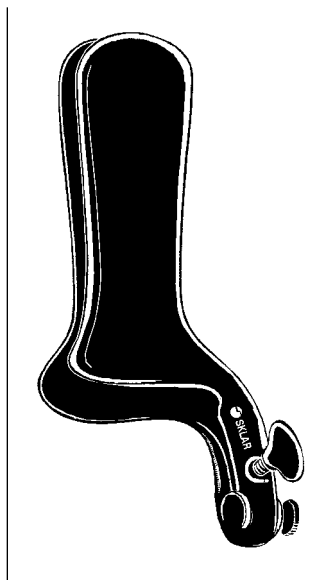
- 90-9106 Medium 2½ lbs. Without loop
- 90-9108 Medium 2½ lbs., With loop to hold and direct disposable evacuation tubing.



**LASER STEINER-AUVARD
VAGINAL SPECULUM**

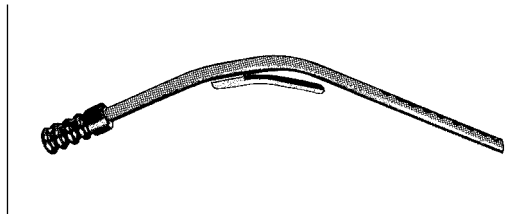
Blades 5½" x 1¼"

- 90-3560 2½ lbs. Without loop
- 90-3561 2½ lbs., With loop to hold and direct disposable evacuation tubing.



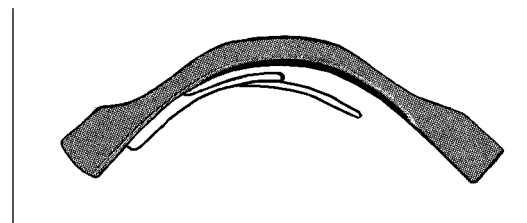
**LASER COLLIN VAGINAL
SPECULUM**

- 90-3946 Medium with Permanent Smoke Evacuation Tube
- 90-3948 Medium with Loop



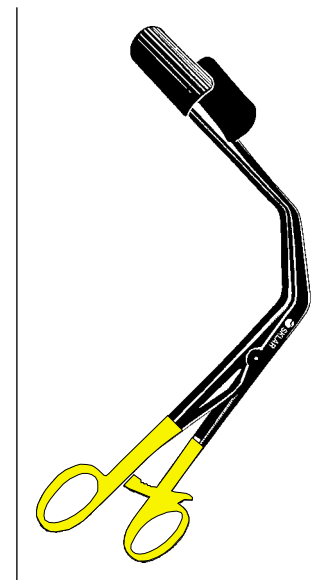
LASER SMOKE EVACUATION TUBE

- 90-8885 Clip-on



**LASER SMOKE EVACUATION
TUBE HOLDER**

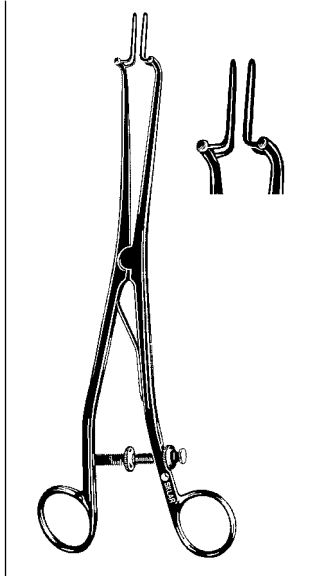
- Holds disposable tubing to top of speculum
- 90-8886



**LASER LATERAL
VAGINAL SPECULUM**

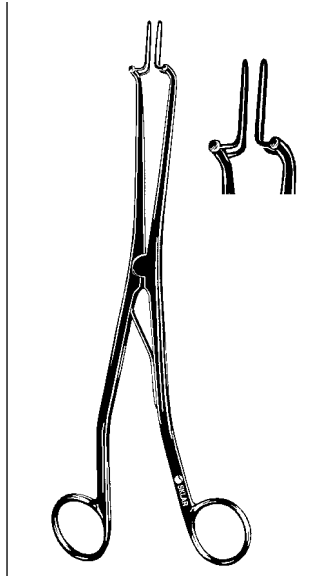
- 90-8845 Ratchet Handle

GYNECOLOGY LASER INSTRUMENTS



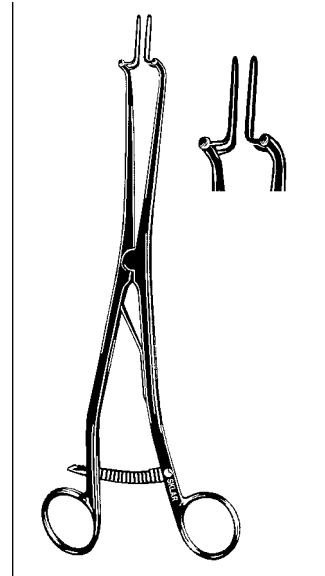
LASER KOGAN ENDOSPECULUM

With Gauge and Screws
90-8855 Narrow Wire Blades



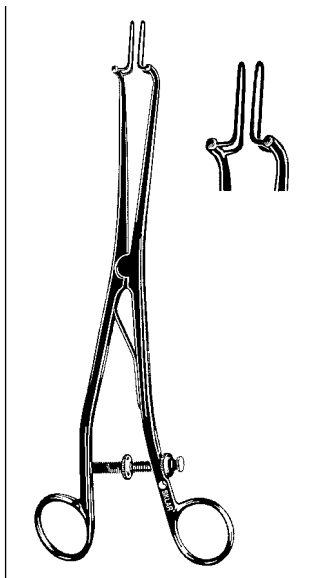
LASER KOGAN ENDOSPECULUM

With Spring
90-8865 Narrow Wire Blades



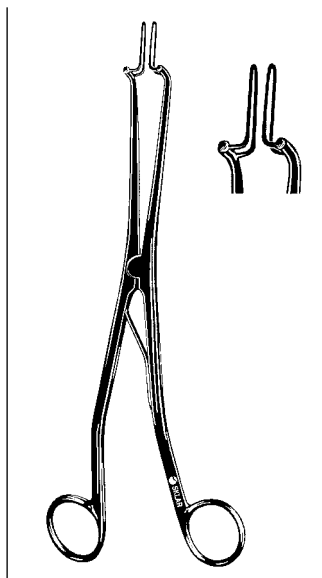
LASER KOGAN ENDOSPECULUM

With Ratchet
90-8862 Narrow Wire Blades



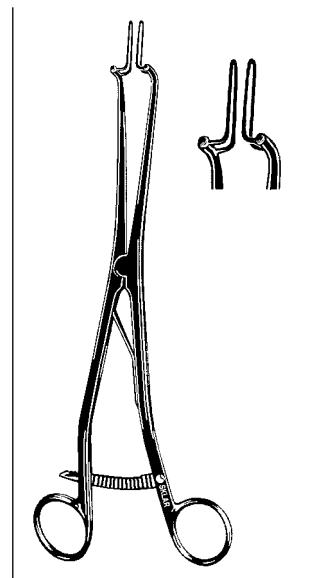
LASER KOGAN ENDOSPECULUM

With Gauge and Screws
90-8858 Wide Wire Blades



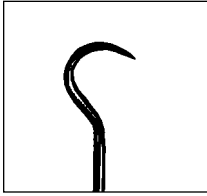
LASER KOGAN ENDOSPECULUM

With Spring
90-8850 Wide Wire Blades

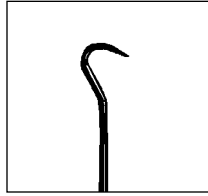


LASER KOGAN ENDOSPECULUM

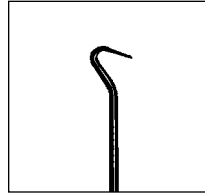
With Ratchet
90-8860 Wide Wire Blades



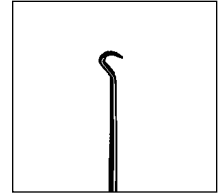
Emmett:
6mm Diameter



Mini Emmett:
4mm Diameter



Maxi Iris:
3mm Diameter



Iris:
1mm Diameter



LASER EMMETT HOOK

90-2114 9" Quick Release
90-2116 12" Quick Release

LASER MINI EMMETT HOOK

90-2118 9" Quick Release
90-2120 12" Quick Release

LASER MAXI IRIS HOOK

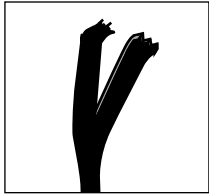
90-2122 9" Quick Release
90-2124 12" Quick Release

LASER IRIS HOOK

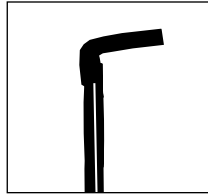
90-2126 9" Quick Release
90-2128 12" Quick Release

Set of All 4-Tissue Hooks
90-2160 9" Quick Release
90-2131 12" Quick Release

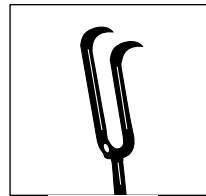
GYNECOLOGY LASER INSTRUMENTS



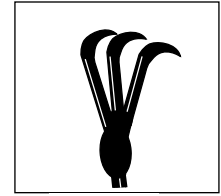
**LASER NEWPORT
CERVICAL
MANIPULATION HOOK**
90-2250



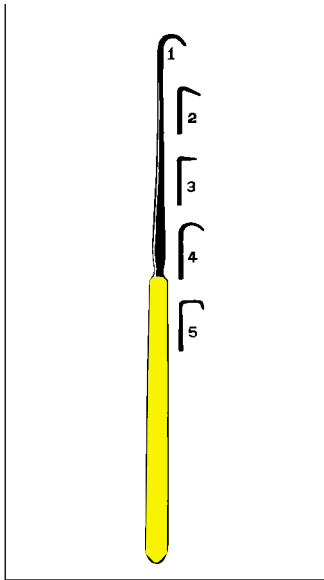
LASER OFFSET HOOK
For Positioning Tissue
90-2254 $\frac{3}{8}$ " 85° Angle



**LASER CHAMPION
CERVICAL HOOK**
Two Sharp Prongs
90-2252 20° Angle

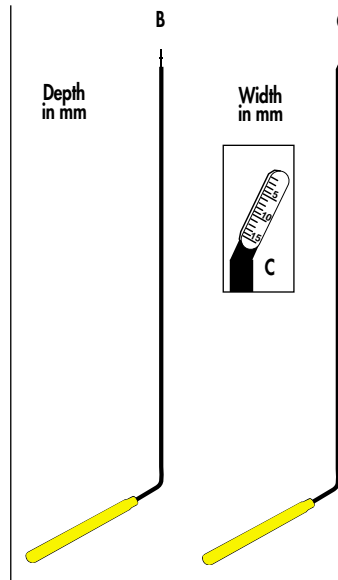


LASER CERVICAL HOOK
Three Sharp Prongs
90-2258



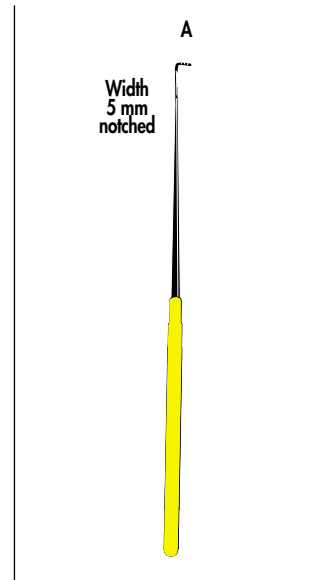
LASER TENACULUM HOOKS

- 90-2171 Emmett #1
- 90-2172 Emmett #2
- 90-2173 Emmett #3
- 90-2174 Emmett #4
- 90-2175 Emmett #5
- 90-2170 Set of 5



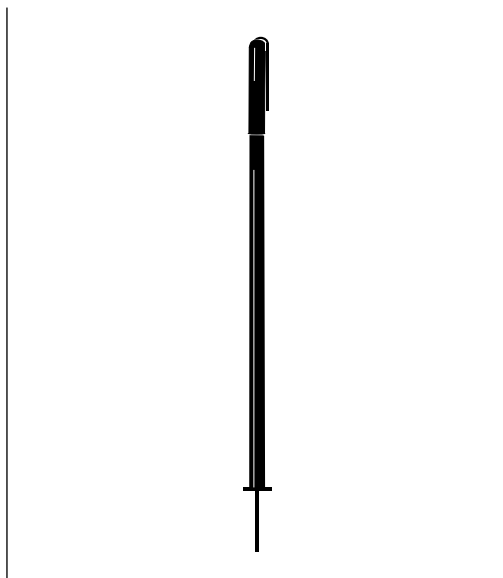
LASER DEPTH AND WIDTH RULERS

- 11" Overall Length
- 90-2242 Depth in mm Style B
- 90-2244 Width in mm Style C



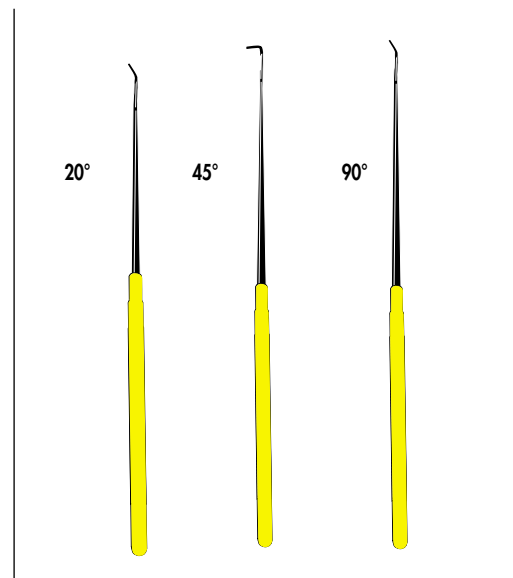
LASER WIDTH RULER

- 11" Overall Length
- 90-2240 Width in mm Style A



LASER DEPTH RULER

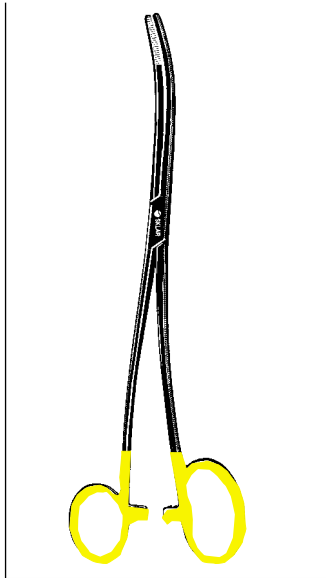
- Designed to be read from proximal end
- 90-2238 Depth in mm



LASER BACKSTOPS

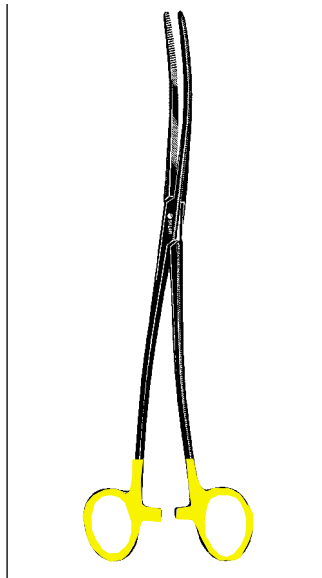
- | | |
|-------------------------|--------------------------|
| 90-2200 3mm 20° 9" | 90-2220 3mm 20° 12" |
| 90-2201 3mm 45° 9" | 90-2222 3mm 45° 12" |
| 90-2202 3mm 90° 9" | 90-2224 3mm 90° 12" |
| 90-2204 3mm 9" Set of 3 | 90-2226 3mm 12" Set of 3 |
| 90-2210 5mm 20° 9" | 90-2230 5mm 20° 12" |
| 90-2212 5mm 45° 9" | 90-2232 5mm 45° 12" |
| 90-2214 5mm 90° 9" | 90-2234 5mm 90° 12" |
| 90-2216 5mm 9" Set of 3 | 90-2236 5mm 12" Set of 3 |

GYNECOLOGY LASER INSTRUMENTS



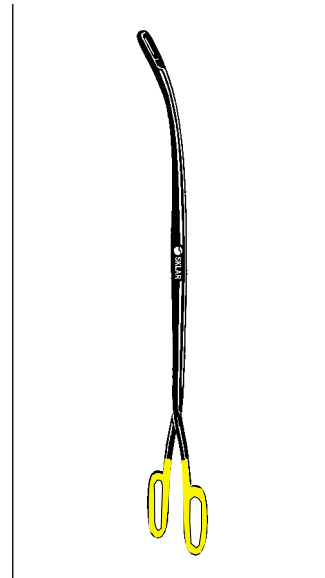
LASER BOZEMAN FORCEPS

One Large Ring
90-2342 10¼" S-Curve



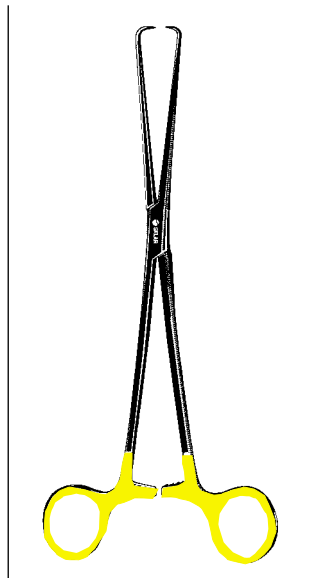
LASER BOZEMAN FORCEPS

90-2340 10¼" S-Curve



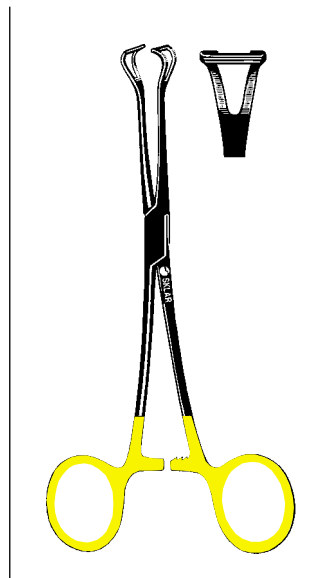
LASER CAMPION GRASPING FORCEPS

90-2298 9¼" Curved



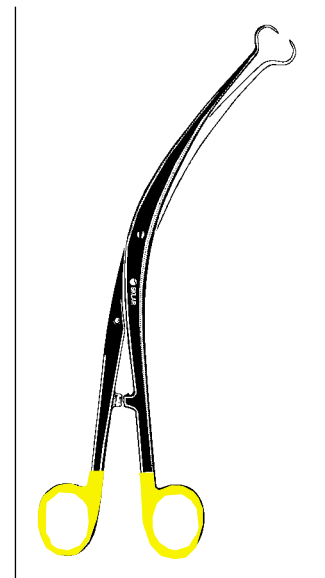
LASER SCHROEDER TENACULUM FORCEPS

90-2325 9½" (Braun)
90-2326 10¼" (Pozzi)



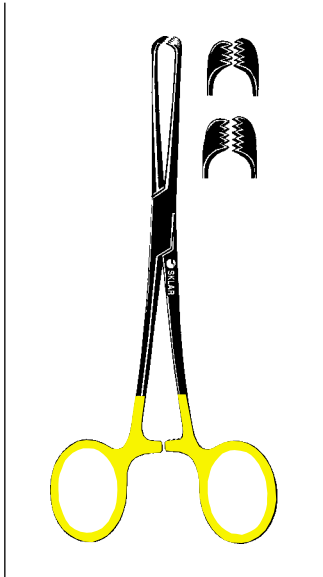
LASER BABCOCK FORCEPS

90-2278 8"
90-2279 9½"



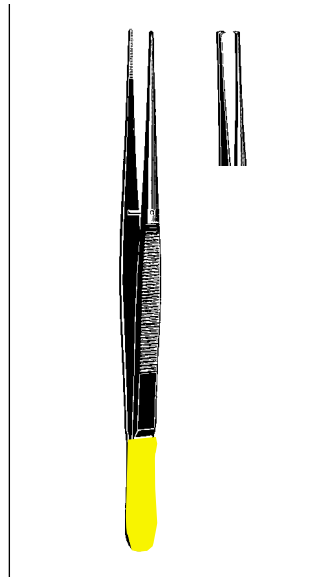
LASER GRAVES TENACULUM FORCEPS

90-2352 9" Curved sideways



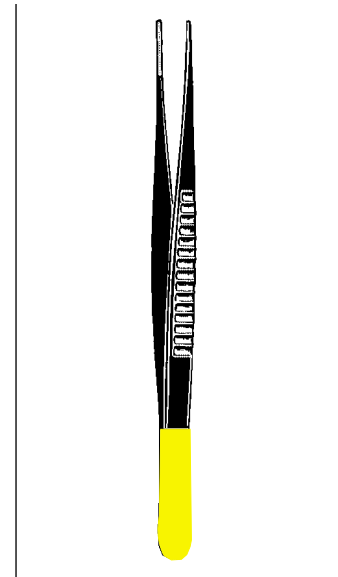
LASER ALLIS/FORCEPS

90-2274 5" Baby Allis
 90-2276 7½" Allis, 5 x 6
 90-2279 9½" Allis, 5 x 6



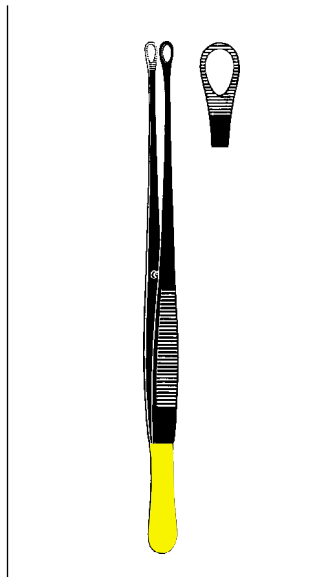
POTTS-SMITH FORCEPS

90-2304 7" Serrated
 90-2306 10" Serrated



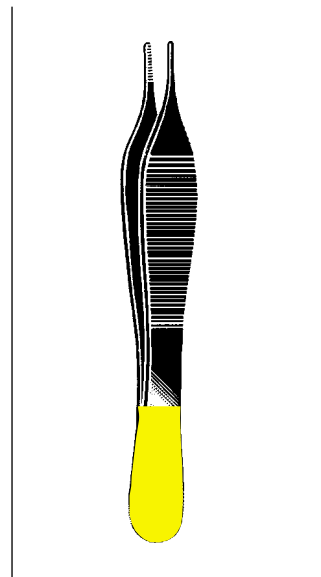
DEBAKEY ATRAUMATIC TISSUE FORCEPS

2.0 mm jaws
 90-2310 7¾"
 90-2312 9½"



LASER TUTTLE/SINGLEY FORCEPS

90-2270 7" Tuttle
 90-2272 9" Singley



LASER ADSON TISSUE FORCEPS

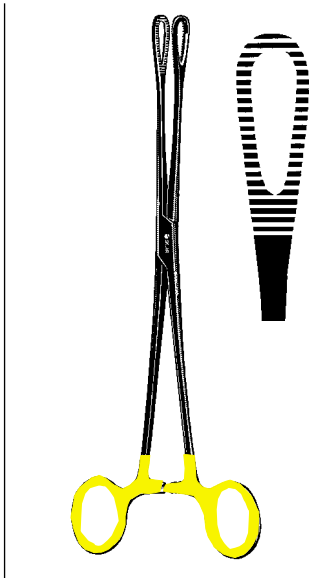
90-2261 Serrated



LASER ROCHESTER-PEAN FORCEPS

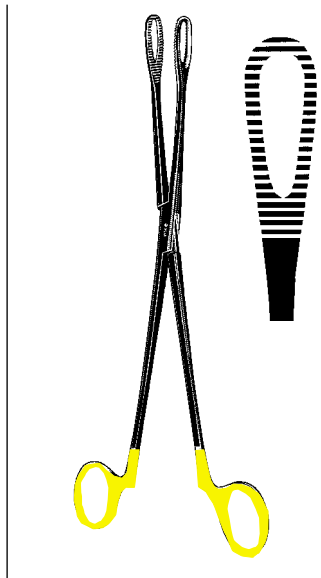
90-2290 7¼" Straight
 90-2292 7¼" Curved
 90-2294 8" Longitudinal, Straight

GYNECOLOGY LASER INSTRUMENTS



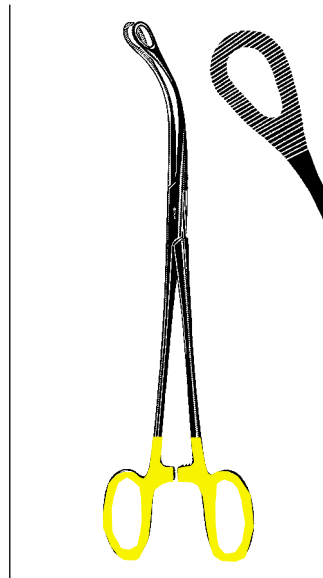
LASER SCHWEIZER FORCEPS

90-2350 9½" Straight



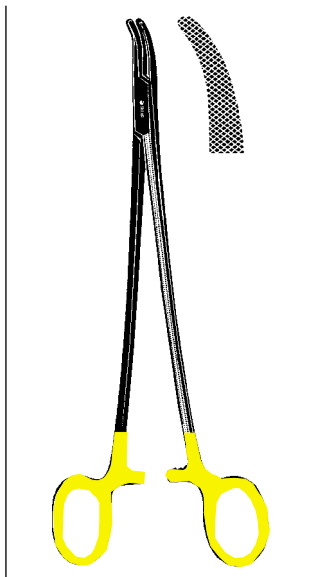
LASER CLEMETSON FORCEPS

90-2348 9½" No-Ratchet



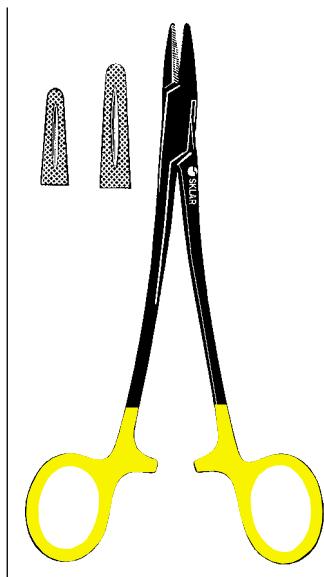
LASER LAUFE UTERINE POLYP FORCEPS

90-2345 7¾" Curved



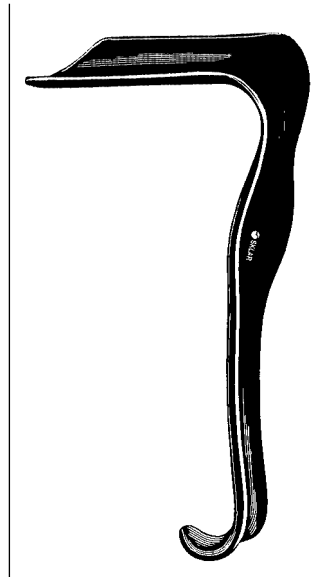
LASER HEANEY NEEDLE HOLDER

90-2330 8¼"



LASER MAYO-HEGAR NEEDLE HOLDER

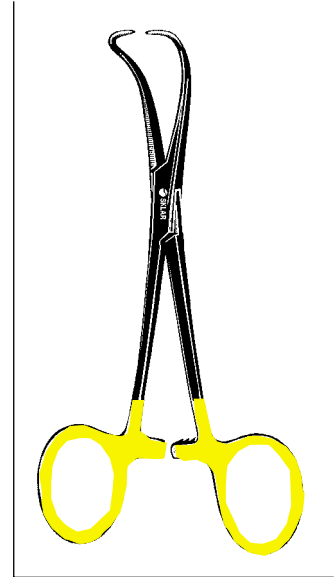
90-2287 7"
90-2288 8"



LASER JACKSON RETRACTOR

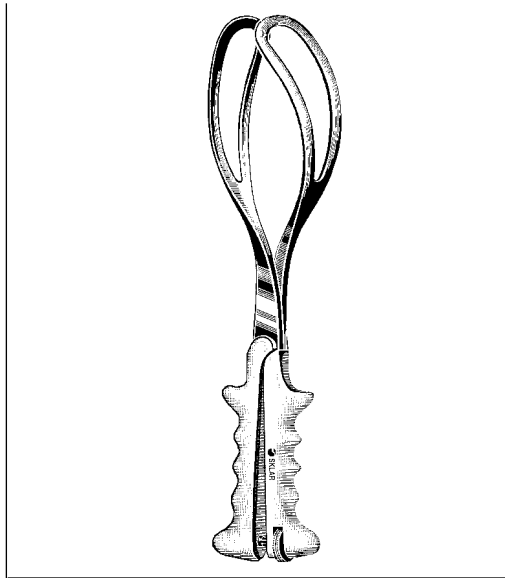
Single End
90-9065 3½" x 1½" Medium
90-9066 3½" x 1½"

With loop to hold and direct disposable smoke evacuation tubing



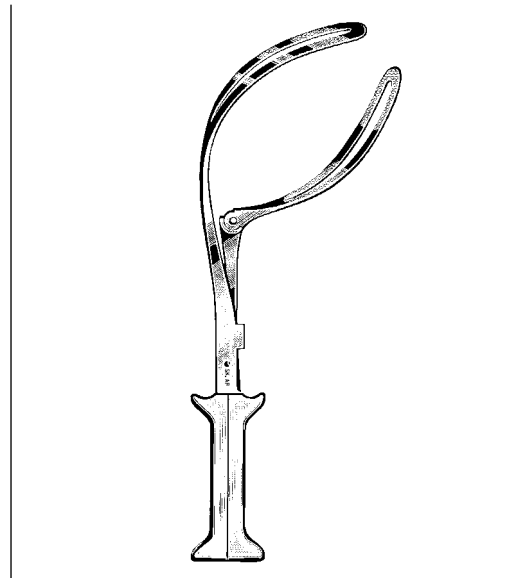
LASER BACKHAUS TOWEL CLAMP

90-2302 3½"
90-2300 5¼"



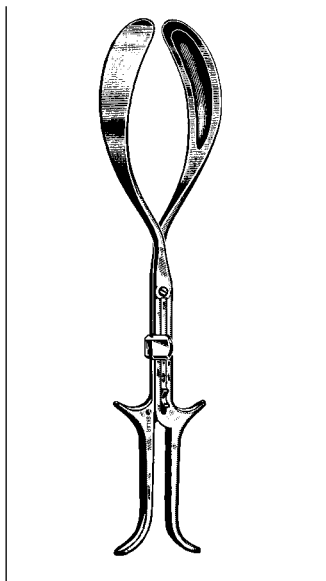
**ELLIOTT OBSTETRICAL
FORCEPS**

92-1715 15" Long



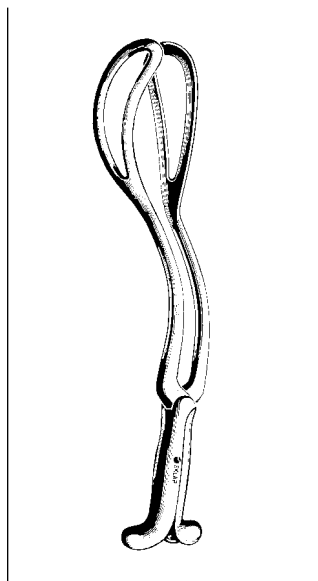
BARTON OBSTETRICAL FORCEPS

92-1814 14"



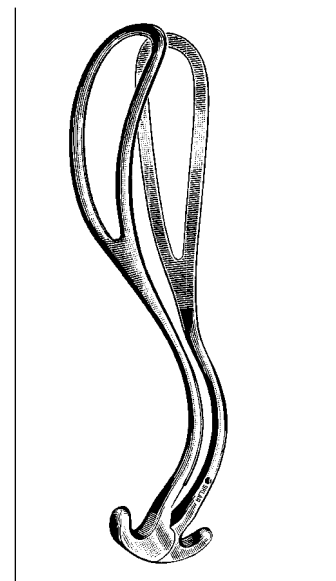
**LAUFE-BARTON-
KIELAND FORCEPS**

92-2516 16" With hinged blade
Luikart modification



**PIPER OBSTETRICAL
FORCEPS**

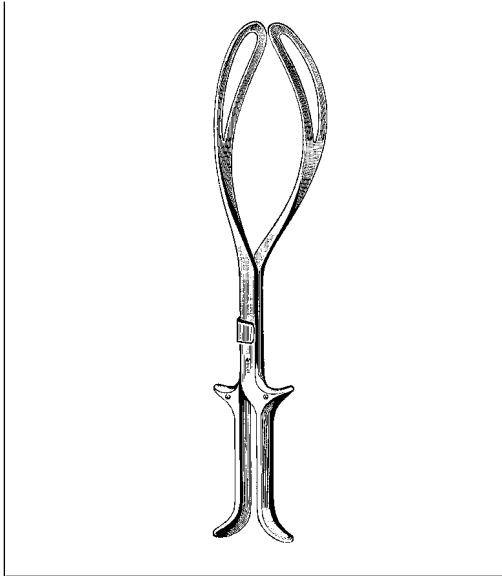
For Breech Presentation
92-2717 17½"



**LAUFE-PIPER
OBSTETRICAL FORCEPS**

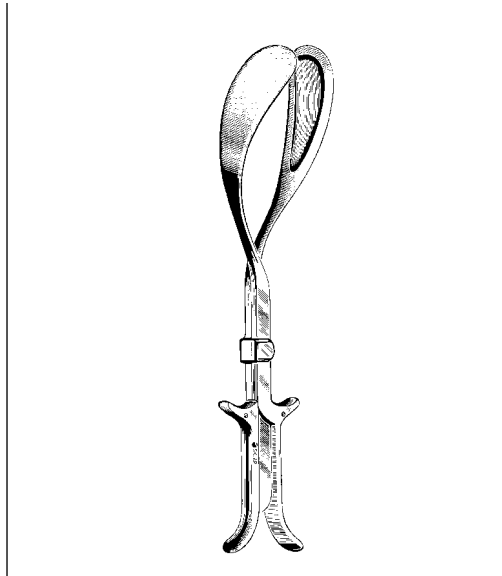
For Breech Presentation
92-2812 12"

OBSTETRICAL FORCEPS



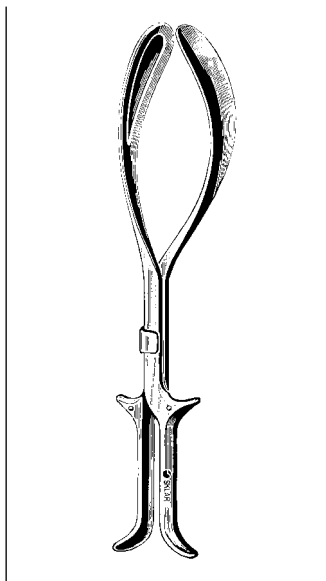
**KIELAND OBSTETRICAL
FORCEPS**

92-1915 15½"



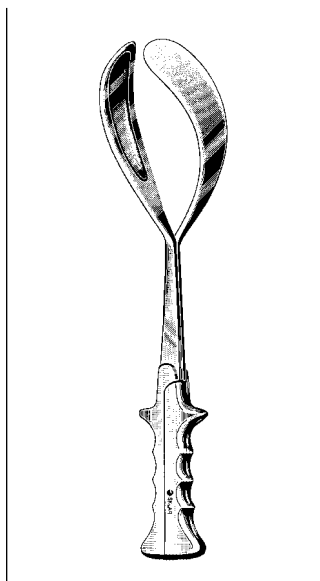
LUIKART OBSTETRICAL FORCEPS

92-2015 15¾"



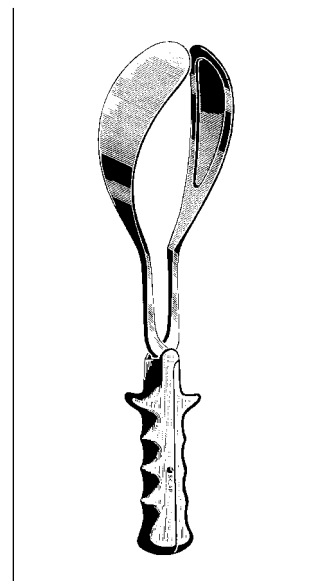
**KIELAND-LUIKART
OBSTETRICAL FORCEPS**

92-2115 15¾"



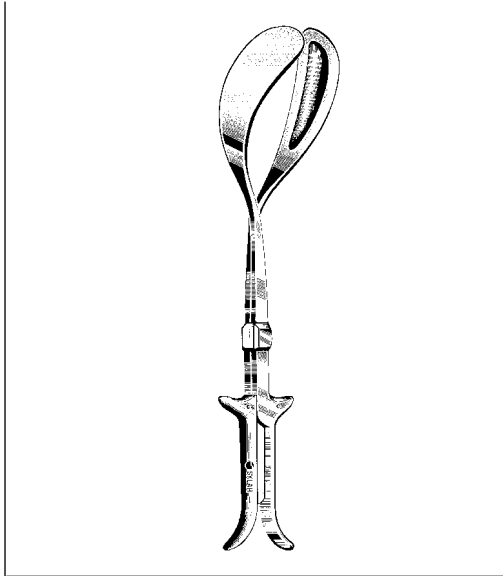
**McLANE-TUCKER-
LUIKART OBSTETRICAL
FORCEPS**

92-2215 15½"



**SIMPSON-LUIKART
OBSTETRICAL FORCEPS**

Long Pattern
92-2314 14"



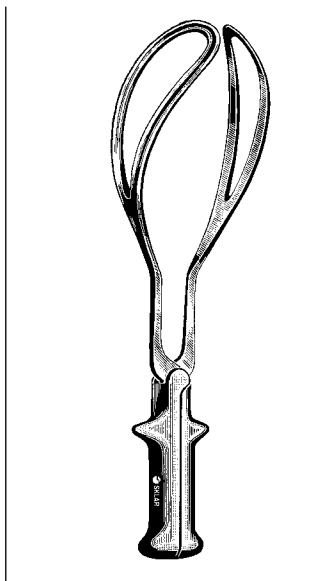
**McLANE-TUCKER-KIELAND
OBSTETRICAL FORCEPS**

Modified by Luikart
92-2415 15 1/4"



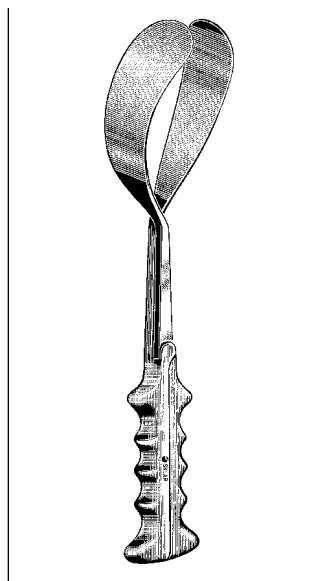
DE LEE OBSTETRICAL FORCEPS

92-1012 Short, for cesarean section, length 12"
92-1014 Standard, length 14"
92-1015 Extra long, length 15 1/4"



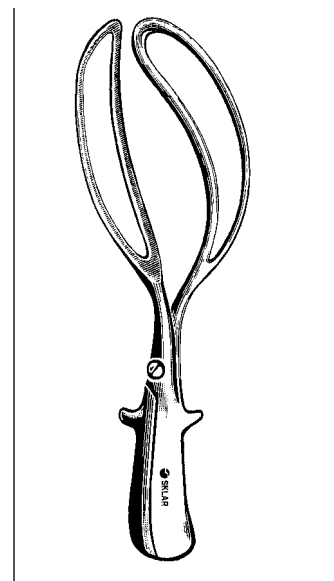
**SIMPSON OBSTETRICAL
FORCEPS**

92-1112 12" Short
92-1114 14 1/4" Long



**McLANE-TUCKER
OBSTETRICAL FORCEPS**

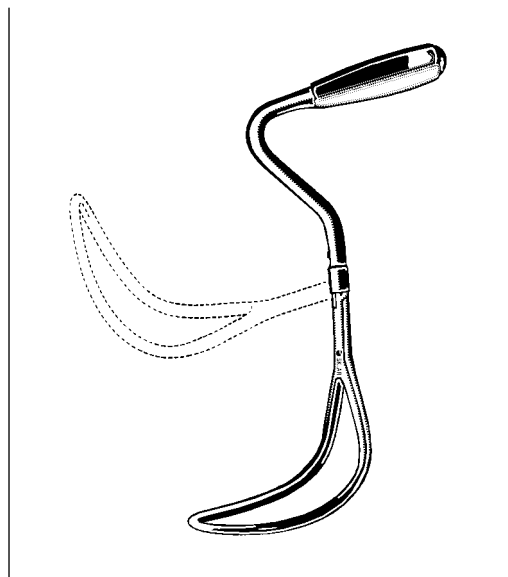
Solid Blades
92-1415 15 1/4"



**HALE OBSTETRICAL
FORCEPS**

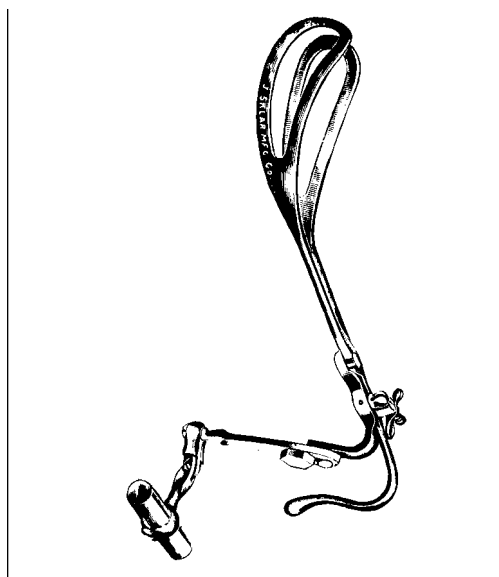
92-1610 10 1/4"

OBSTETRICAL FORCEPS



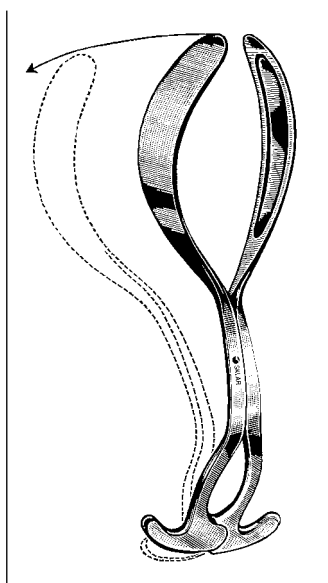
MURLESS HEAD EXTRACTOR

For Caesarean
92-2915 10"



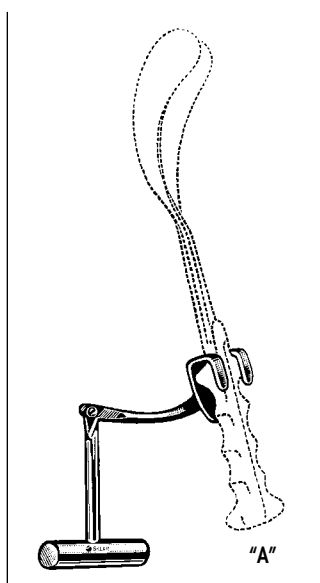
DEWEY OBSTETRICAL FORCEPS

92-3215 15" Axis Traction



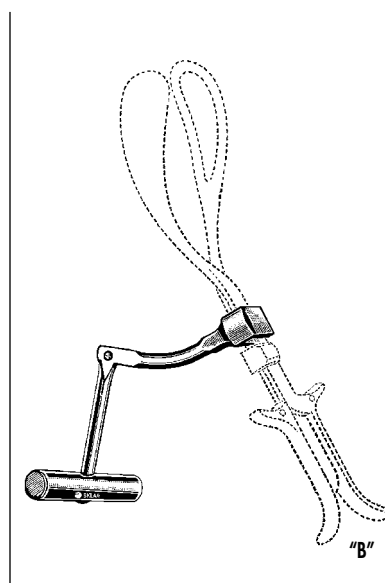
LAUFE DIVERGENT OUTLET OBSTETRICAL FORCEPS

92-2912 12½"



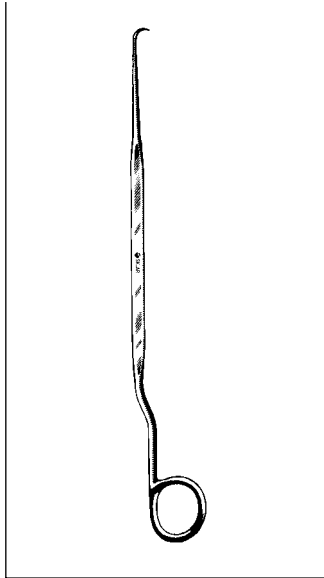
BILL TRACTION HANDLE

For Use on Standard Forceps
92-3350 "A"



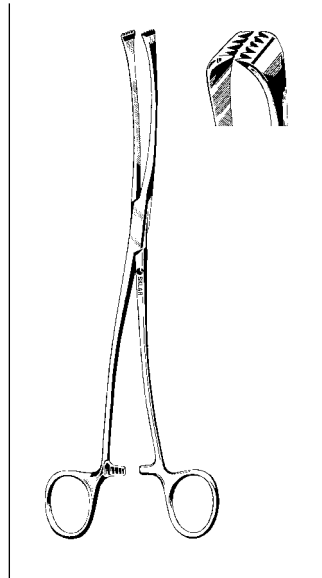
LUIKART-BILL TRACTION HANDLE

For Use with Luikart Handles
92-3360 "B"



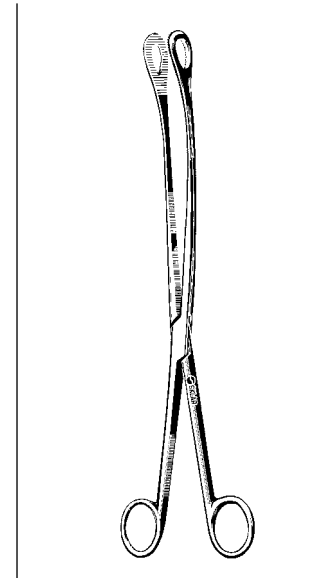
BEACHAM AMNIOTOME

91-4210 10½" (26 cm)



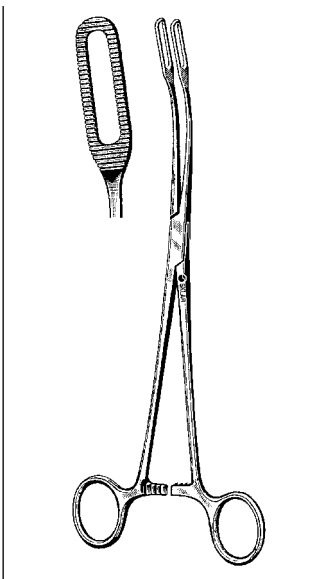
**IOWA MEMBRANE
FORCEPS**

91-4310 10"



**KELLY PLACENTA
FORCEPS**

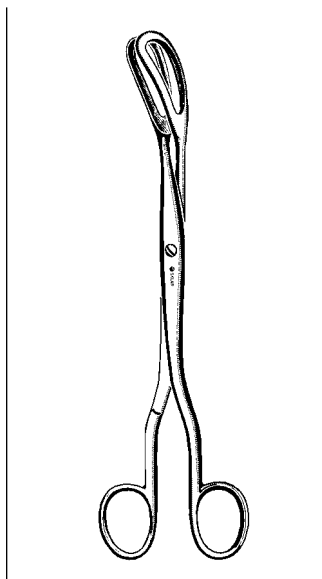
Curved
92-5012 12"



**JAVERTS PLACENTA
FORCEPS**

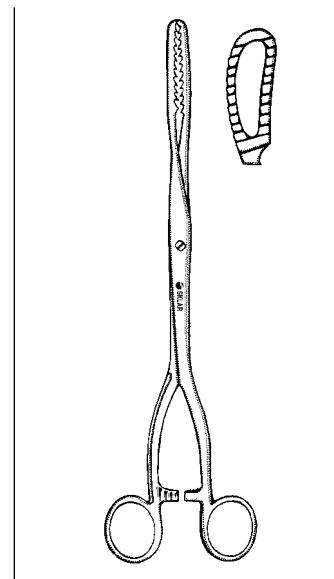
(Long Island College)

92-5095 9½" Serrated
92-5195 9½" Smooth



COREY OVUM FORCEPS

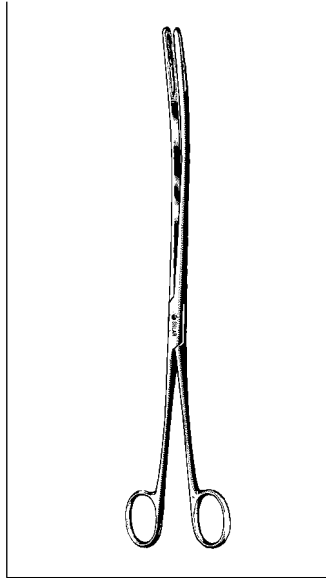
92-5295 9½"



BIERER OVUM FORCEPS

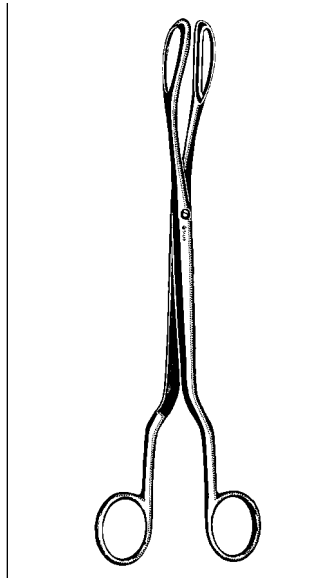
Serrated Jaw
92-5298 11" 16 mm

OBSTETRICAL FORCEPS



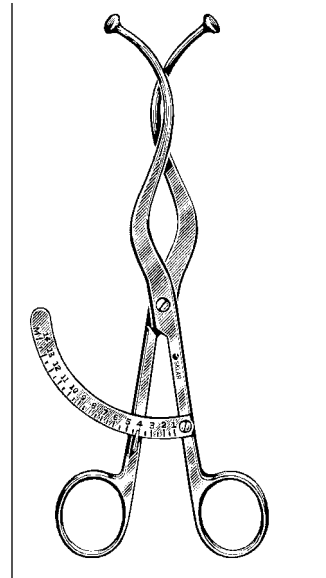
**BOND PLACENTA
FORCEPS**

92-5412 12"



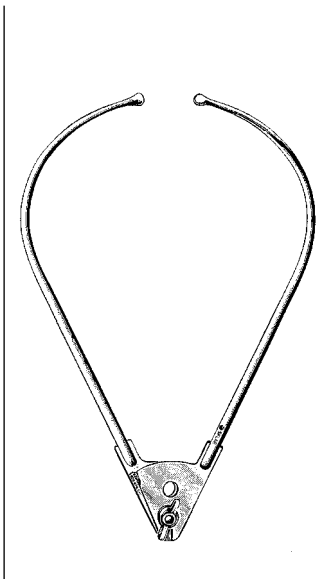
**BARRETT PLACENTA
FORCEPS**

92-5310 10"



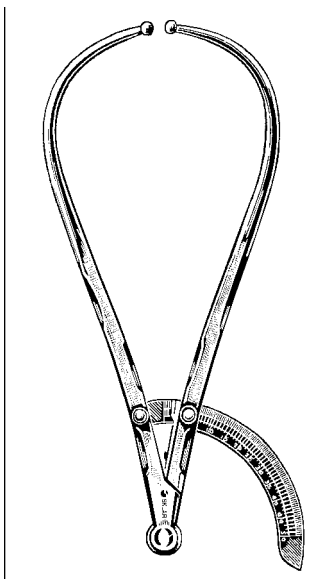
**DELEE INTERNAL
PELVIMETER**

92-4165



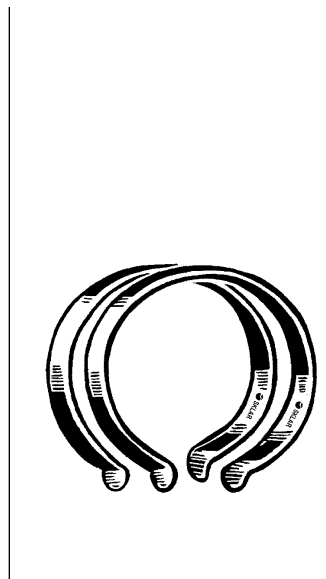
COLLYER PELVIMETER

92-4100



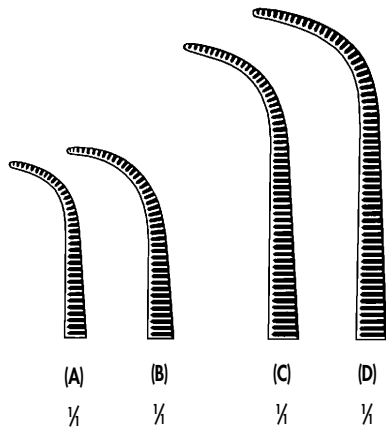
MARTIN PELVIMETER

92-4130

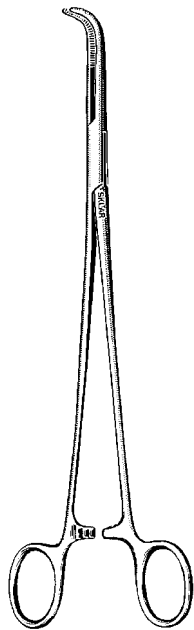


BETHEA SHEET HOLDER

92-6535 Pair

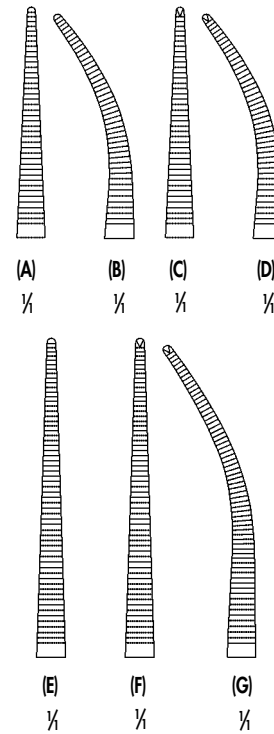


(A) 5 1/2"
(B) 6 1/4"
(C) 8"
(D) 9"

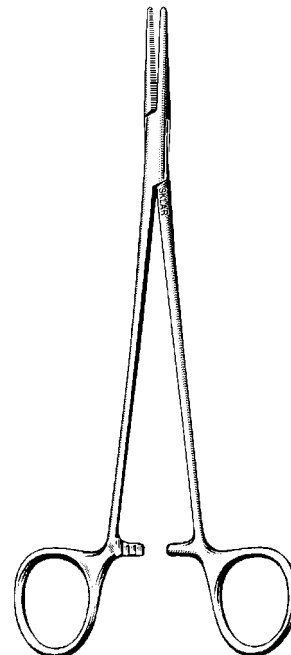


GEMINI FORCEPS DELICATE RIGHT ANGLE

- 55-2855 5 1/2" (A)
- 55-2870 6 1/4" (B)
- 55-2880 8" (C)
- 55-2890 9" (D)
- 55-2898 11"

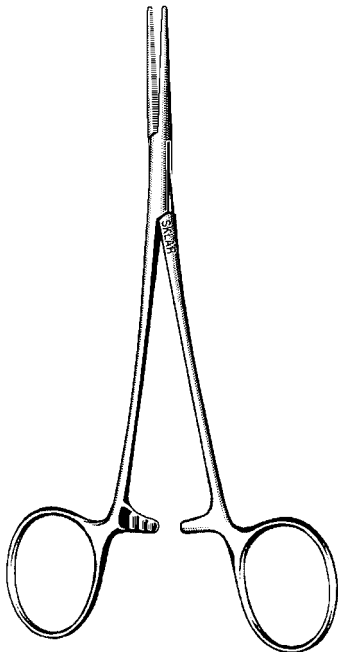
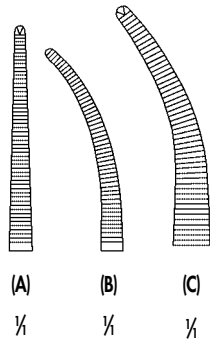


(A) 7"
(B) 7"
(C) 7"
(D) 7"
(E) 8 1/4"
(F) 8 1/4"
(G) 8 1/4"



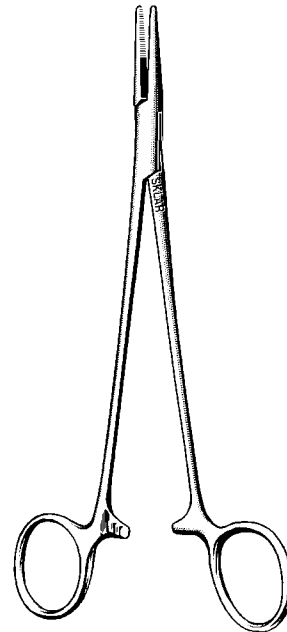
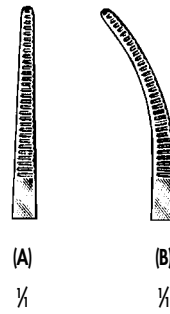
DELICATE-LONG MOSQUITO FORCEPS

- 55-2021 7" Straight Serrated (A)
- 55-2022 7" Curved Serrated (B)
- 55-2023 7" Straight Serrated 1x2 (C)
- 55-2024 7" Curved Serrated 1x2 (D)
- 55-2025 8 1/4" Straight Serrated (E)
- 55-2026 8 1/4" Straight Serrated 1x2 (F)
- 55-2027 8 1/4" Curved Serrated 1x2 (G)



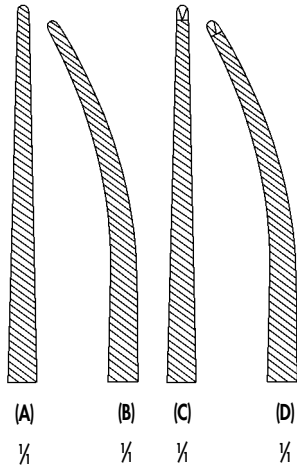
LERICHE FORCEPS

- 55-2035 6 1/2" Straight Serrated 1 x 2 (A)
- 55-2038 7" Curved Serrated (B)
- 55-2040 7" Curved Heavy Serrated 1 x 2 (C)

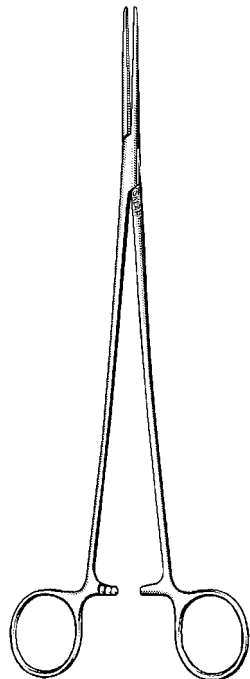


ADSON FORCEPS

- 50-1372 7 1/2" Straight Half Serrated (A)
- 50-1472 7 1/2" Curved Half Serrated (B)



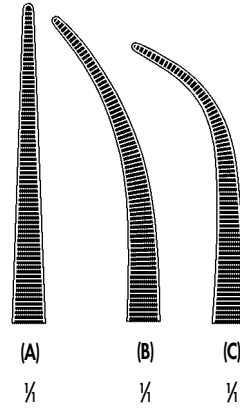
(A) 1/4
(B) 1/4
(C) 1/4
(D) 1/4



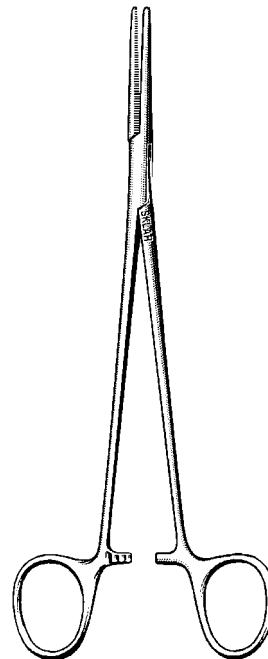
BENGOLEA FORCEPS

Diagonal Serrations

55-2045	8 1/4"	Straight Serrated (A)
55-2050	10 1/4"	Curved Serrated (B)
55-2060	10 1/4"	Straight Serrated 1x2 (C)
55-2062	10 1/4"	Curved Serrated 1x2 (D)

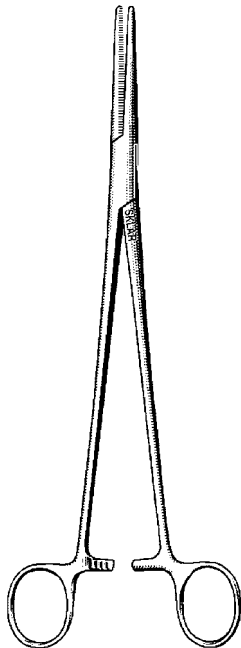
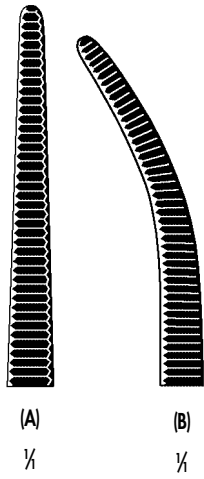


(A) 1/4
(B) 1/4
(C) 1/4



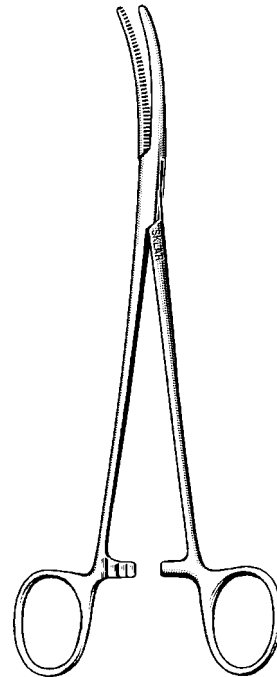
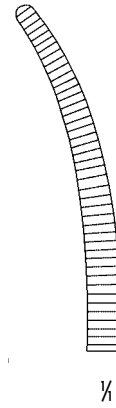
HEISS FORCEPS

55-2320	8"	Serrated Straight (A)
55-2322	8"	Serrated Half-Curved (B)
55-2324	8"	Serrated Full-Curved (C)



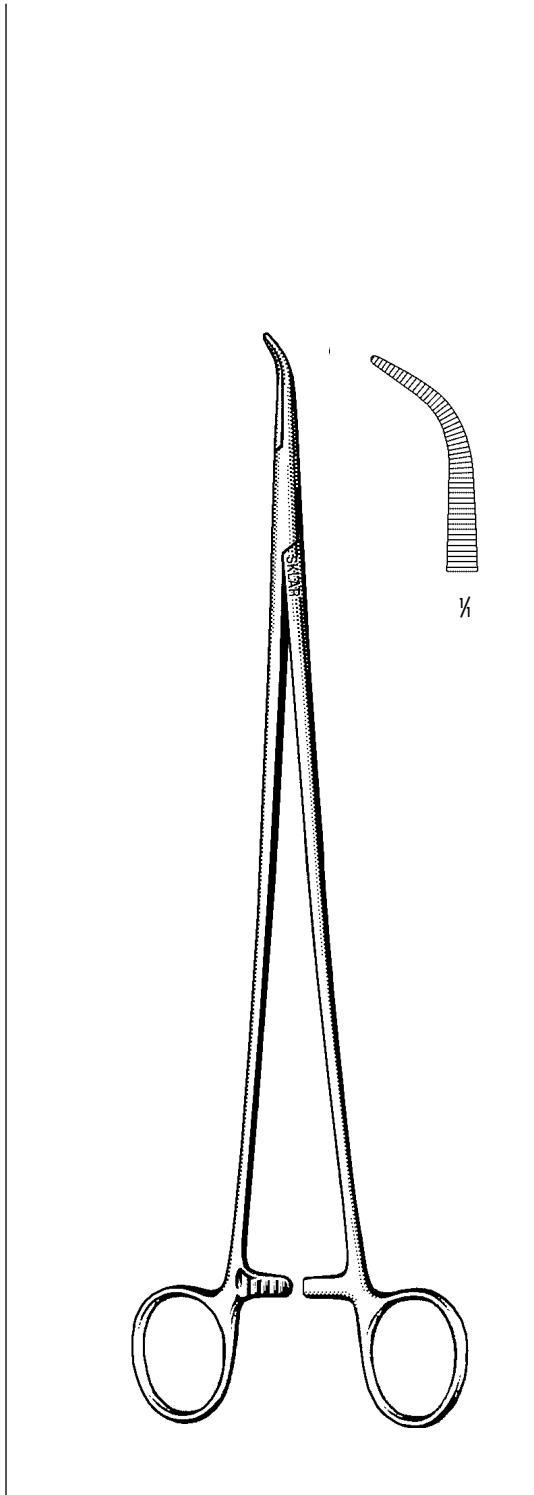
ROBERTS FORCEPS

55-2682 9 $\frac{3}{4}$ " Straight Serrated (A)
55-2684 9 $\frac{3}{4}$ " Curved Serrated (B)

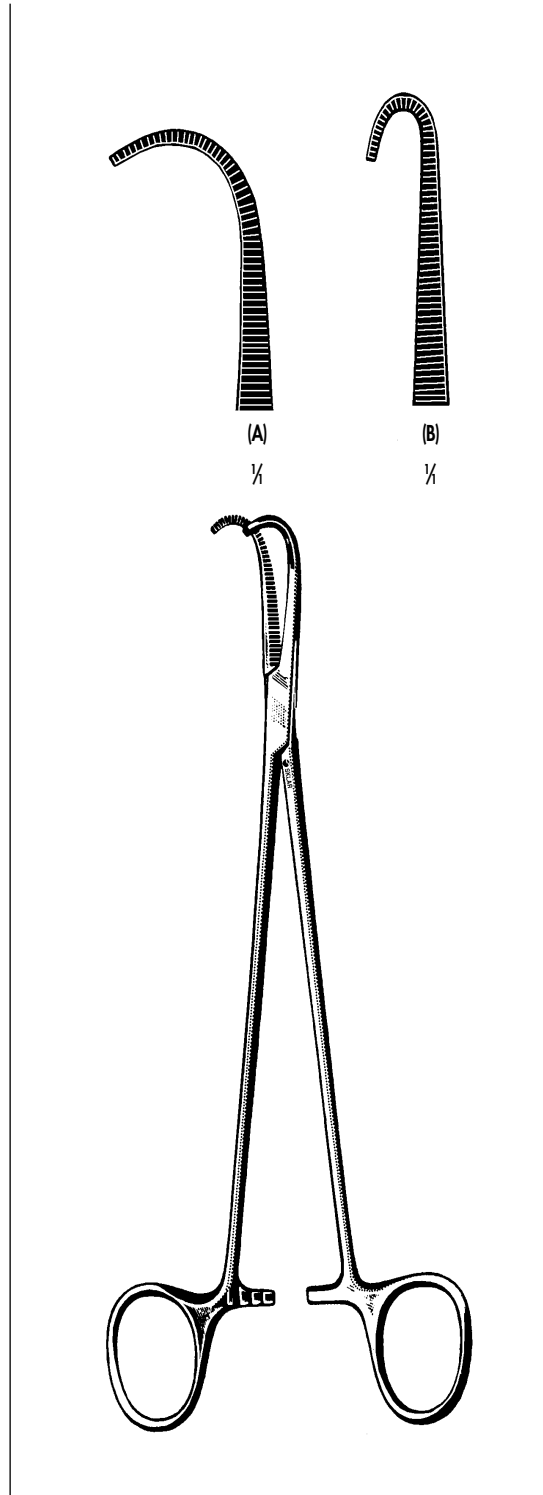


VANDERBILT UNIVERSITY FORCEPS

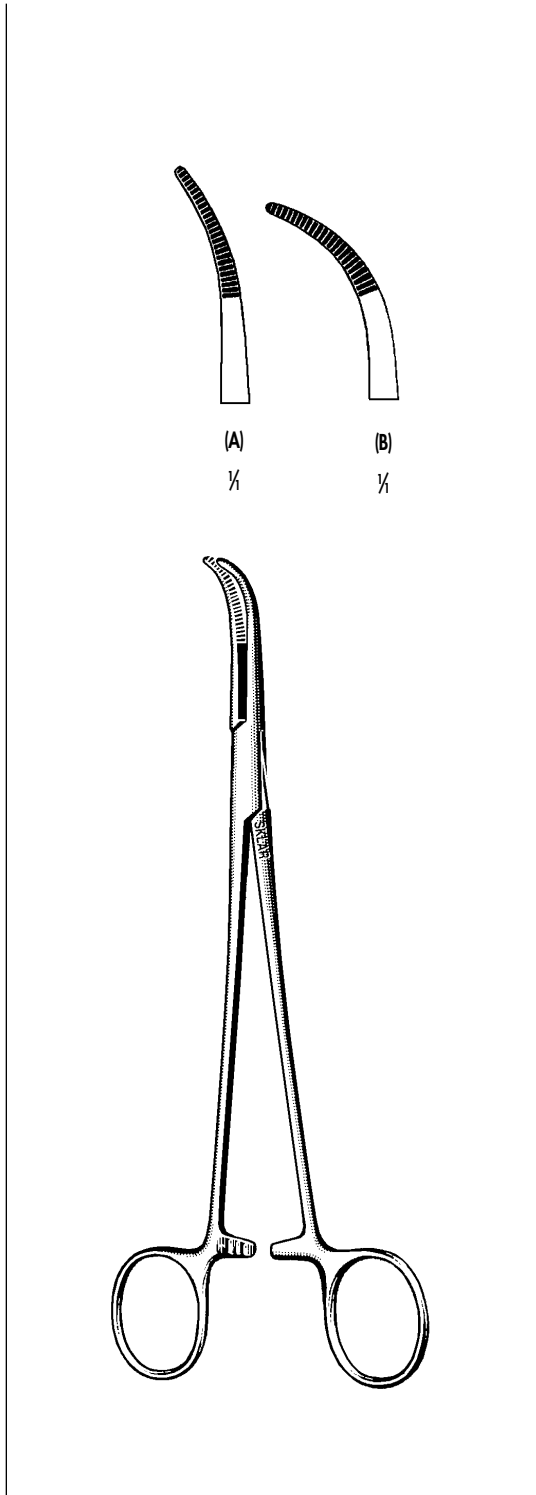
55-2688 8 $\frac{1}{2}$ " Curved Serrated



LAWRENCE FORCEPS
55-2685 10 1/2" Curved Serrated

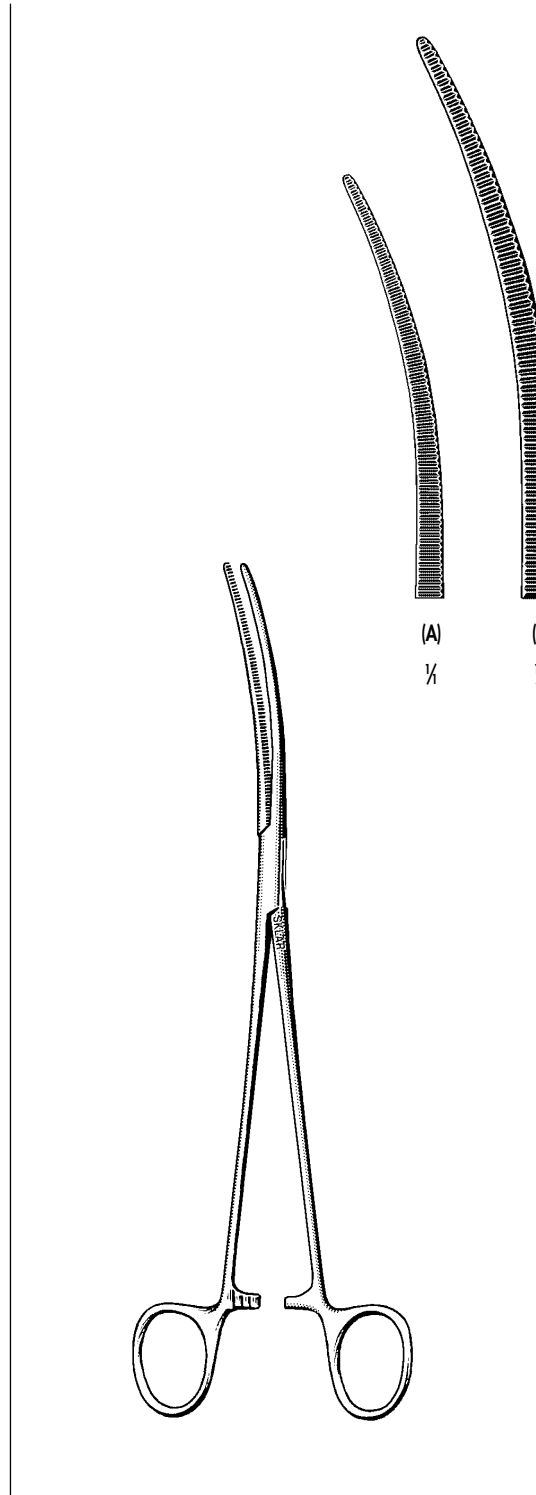


NEGUS HEMOSTATIC FORCEPS
55-2340 7 1/2" Small Hook Shaped Curve (B)
55-2342 7 1/2" Full Curve (A)



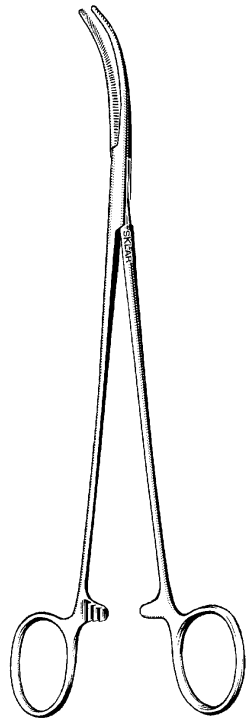
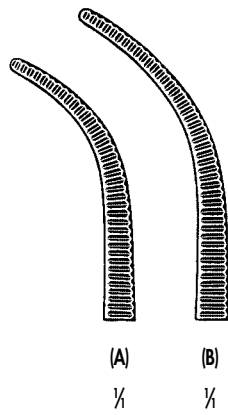
SCHNIDT FORCEPS

- 74-3075 7½" Serrated Half Curved (A)
- 74-3175 7½" Serrated Full Curved (B)



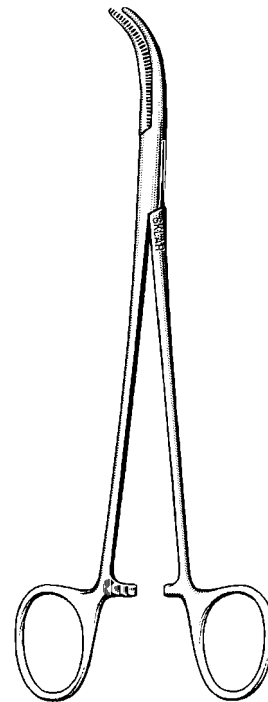
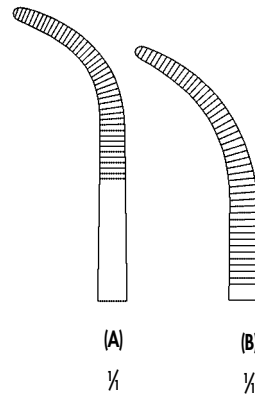
CRAFORD FORCEPS

- 55-2330 7" Curved Serrated (A)
- 55-2334 9½" Curved Serrated (B)



OVERHOLT FORCEPS

- 55-2187 8 1/4" Small Jaw (A)
- 55-2190 8 1/4" Medium Jaw (B)

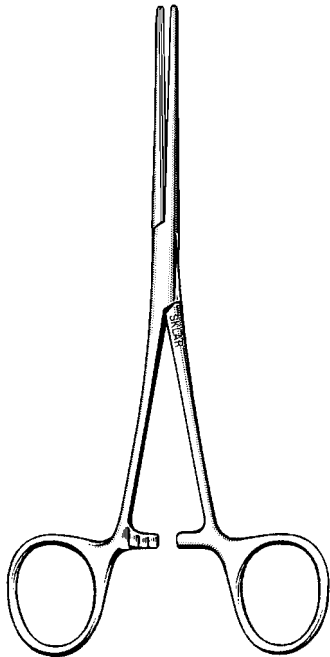


OVERHOLT-GEISSENDOERFER FORCEPS

- 55-2350 8 1/4" Curved Half-Serrated (A)
- 55-2352 8 1/4" Curved Full-Serrated (B)



1/4

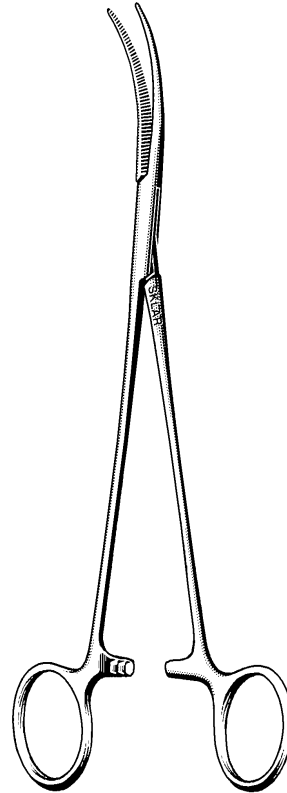


BAINBRIDGE FORCEPS

17-3660 6" Longitudinal Serrations

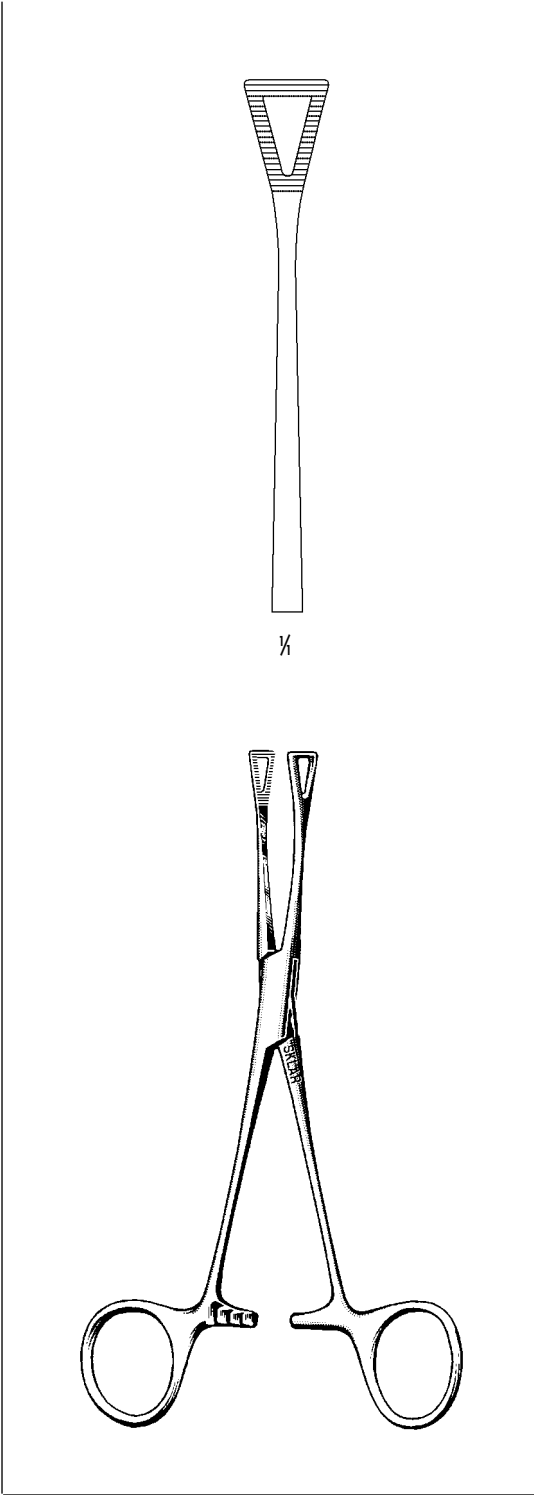


1/4



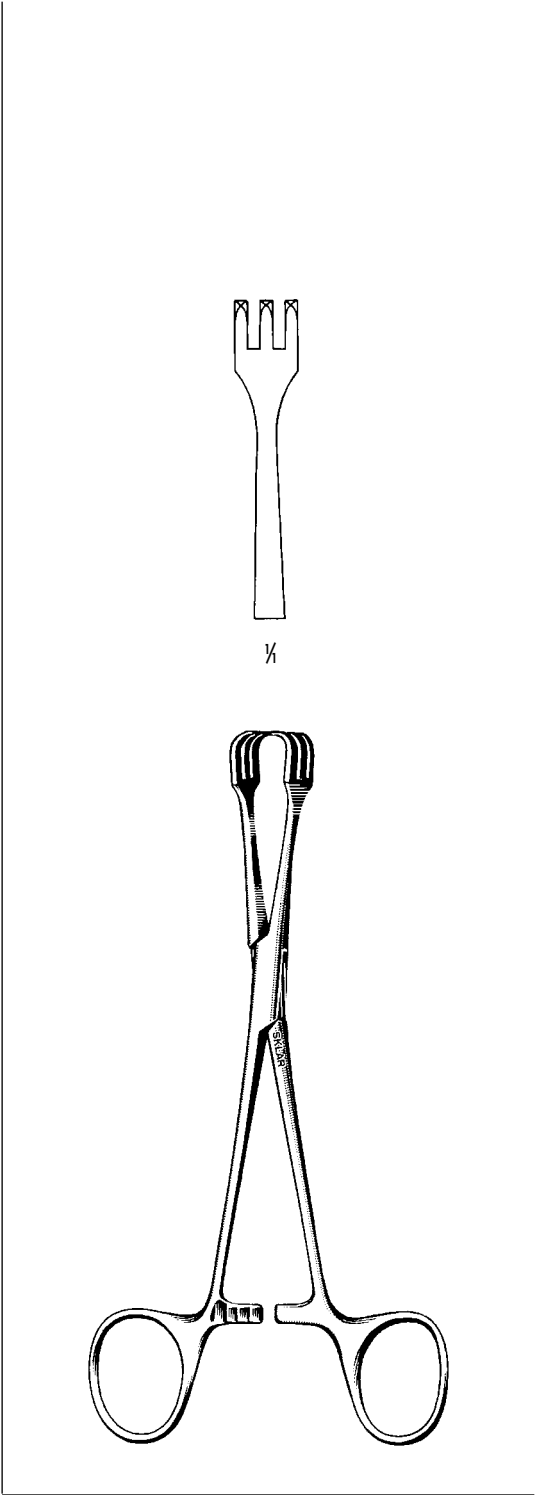
SKLAR SPECIAL HEMOSTATIC FORCEPS

55-2360 9 1/2" Curved Serrated
With Very Fine Tips



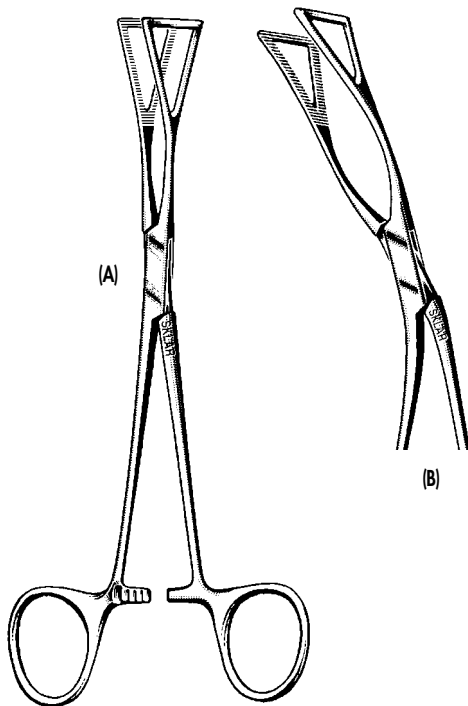
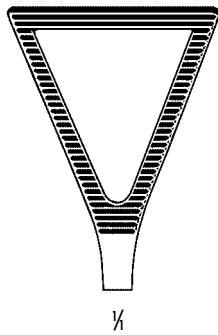
PENNINGTON GRASPING FORCEPS

17-2957 5½"
17-2958 8"



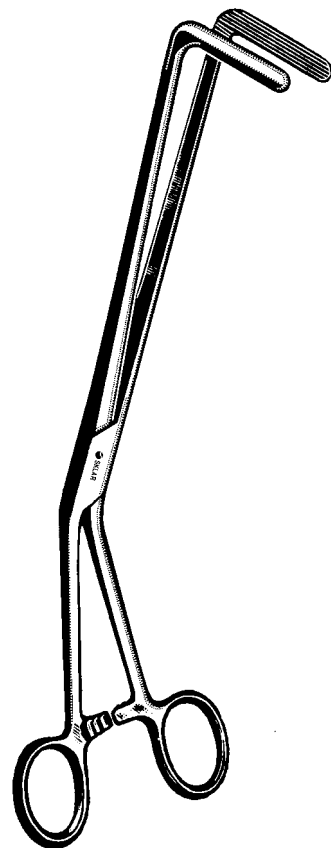
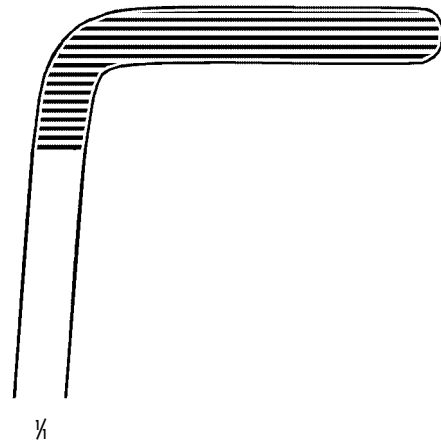
LAHEY TRACTION FORCEPS

17-3562 6¼"



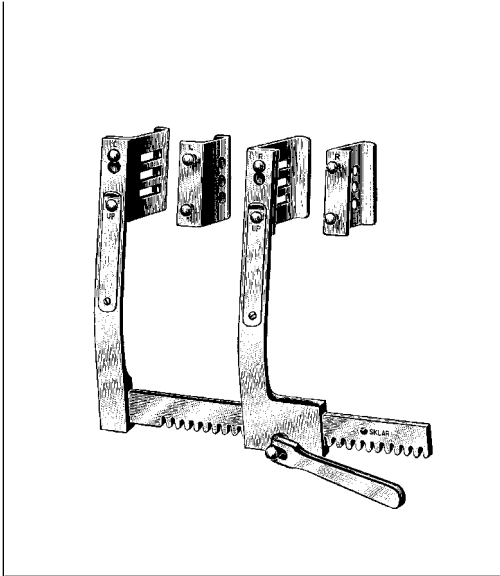
LOVELACE GRASPING FORCEPS

32-2477 7½" Straight (A)
32-2470 7" Angled To Side (B)



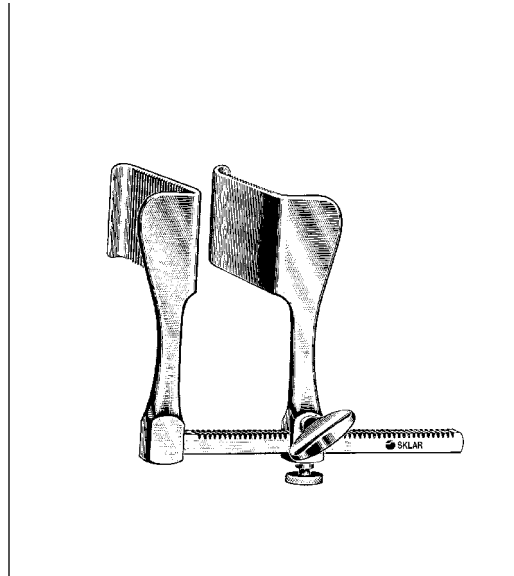
HARRINGTON CLAMP FORCEPS

55-2311 11¾"



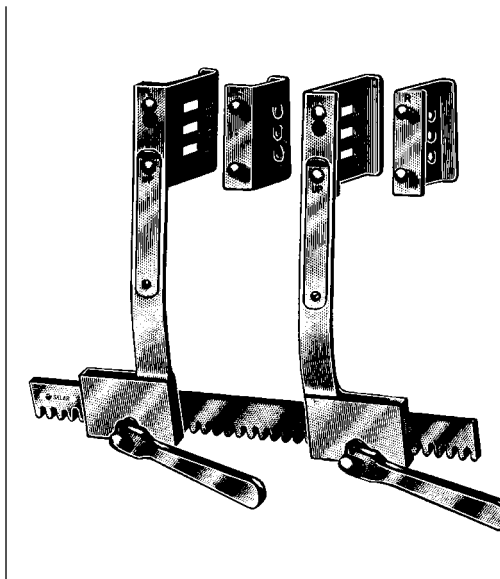
BURFORD-FINOCHIETTO RIB SPREADER

2 sets of blades
 55-7880 2½" x 2½" 8" spread
 1½" x 2½"



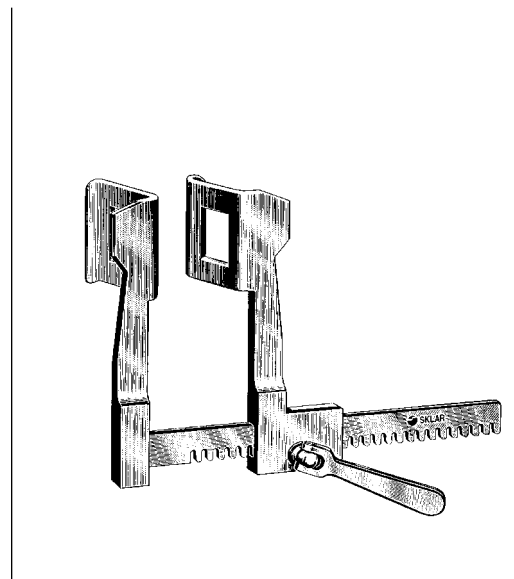
TUFFIER RIB SPREADER

55-7445 2" x 2" 4½" Spread
 55-7465 2" x 2" 6½" Spread



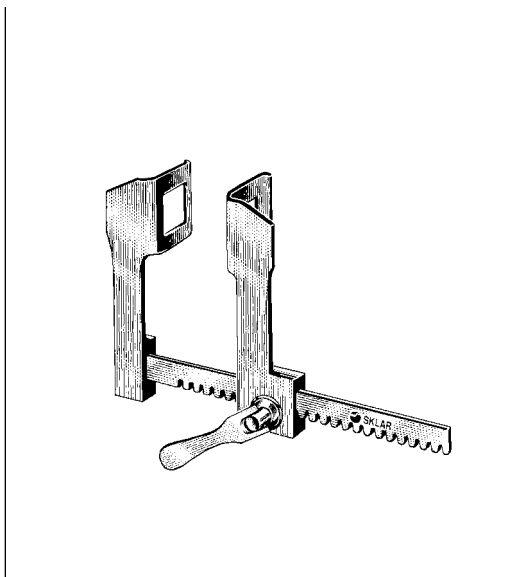
BURFORD-FINOCHIETTO RIB SPREADER

55-7980 With both arms movable and two sets of interchangeable blades, large, 2½" x 2½" (6.4 x 7 cm), small, 1½" x 2½" (6.4 x 5.1 cm), curved arms, total opening 8" (20.3 cm)



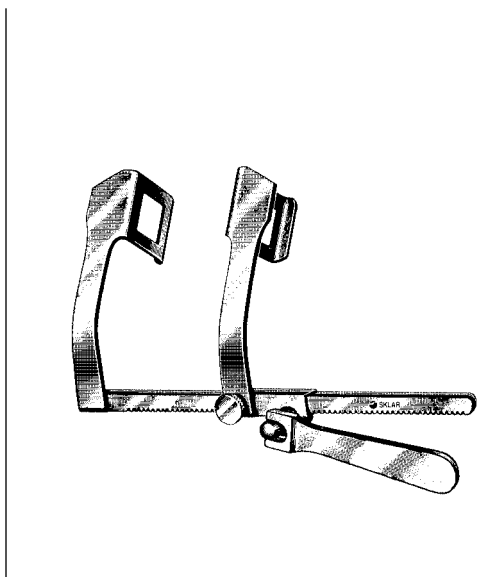
FINOCHIETTO RIB SPREADER

55-7675 1¼" x 1¾" 6" Spread
 55-7685 1¼" x 2½" 8½" Spread



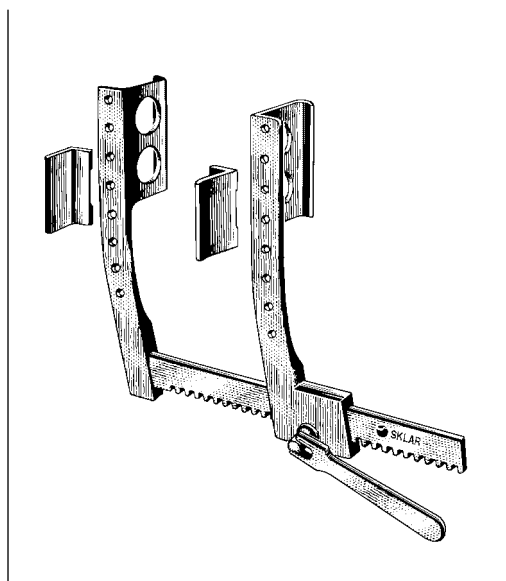
**HAIGHT-FINOCHIETTO
RIB RETRACTOR**

22-7855 Total opening 3"



WILSON RIB SPREADER

22-7875 1½" x 1½"
Total opening 7"



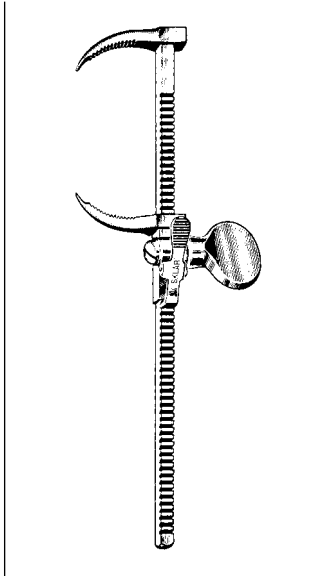
HARKEN RIB SPREADER

55-7785 1¾" deep x 3" wide, solid
scapula blades, 1½" deep x 2"
wide, total opening 8½"



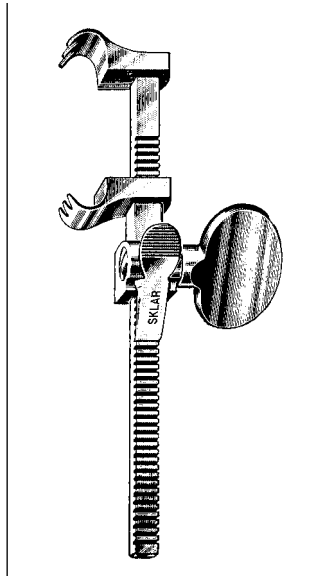
NELSON RETRACTOR (GOSSET)

Self-Retaining
55-7355 2½" x 1" blades 5½" spread
60-6240 ¾" x 1½" blades 4" spread



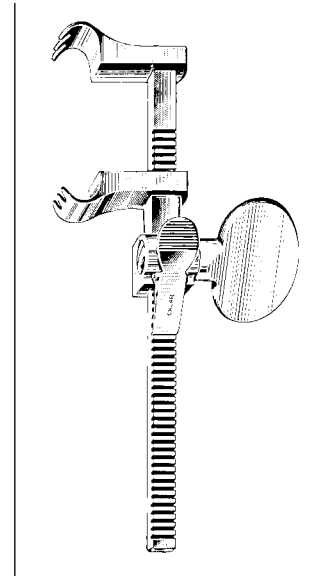
LEMMON STERNAL APPROXIMATOR

55-7360



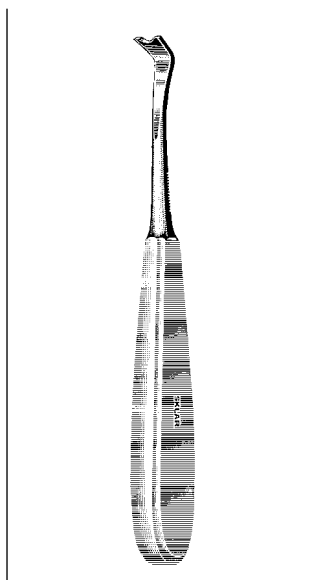
BAILEY RIB CONTRACTOR

55-7365



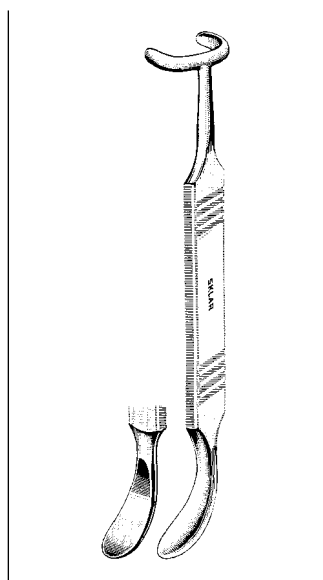
BAILEY-GIBBON RIB CONTRACTOR

55-7366 Adult



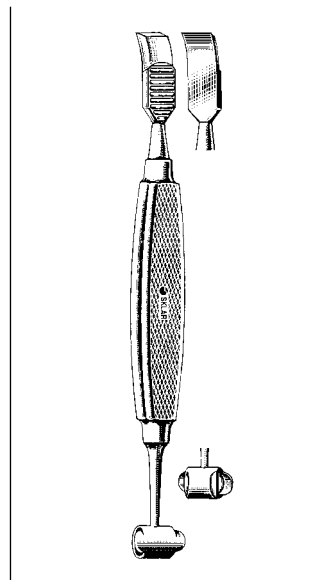
SEMB RASPATORY

Notched End
55-4510 Angular 8"



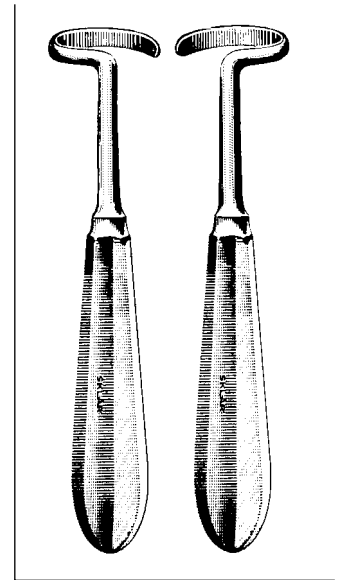
MATSON RIB STRIPPER

Double End
55-6887 Adult 8 1/2"



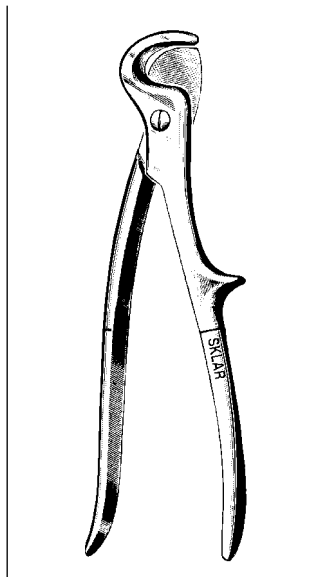
ALEXANDER RASPATORY

Double End
22-7560 Pediatric 6"
55-5980 Adult 8"



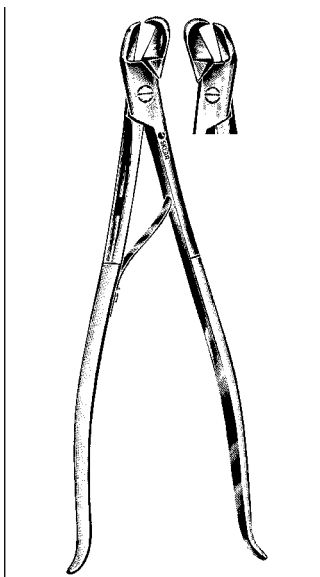
DOYEN RIB RASPATORY

22-7660 Pediatric Right 6"
22-7760 Pediatric Left 6"
55-6965 Adult Right 6 1/2"
55-7065 Adult Left 6 1/2"



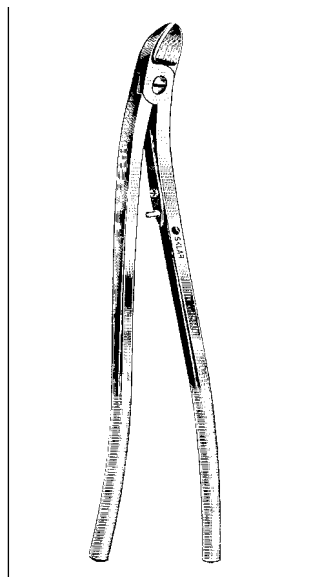
STILLE RIB SHEARS

55-1685 8½"



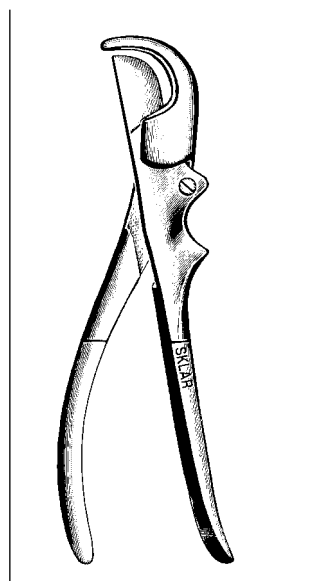
CORYLLOS RIB SHEARS

55-1414 14" Right
55-1514 14" Left



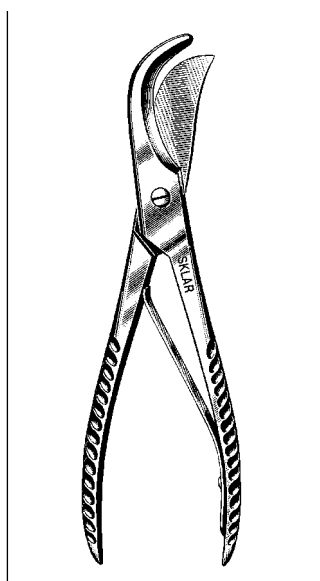
BETHUNE RIB SHEARS

55-1614 14" (Nelson)



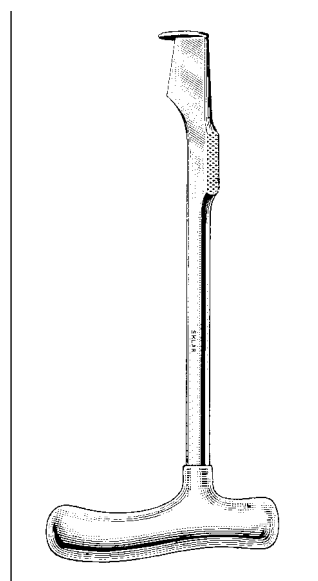
GLUCK RIB SHEARS

55-1687 8¾"



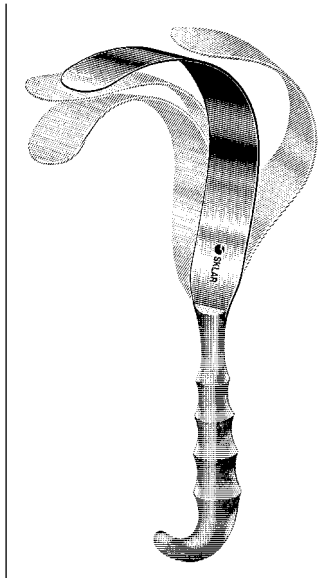
COLLINS RIB SHEARS

55-1692 9½"



**LEBSCHE STERNUM
CHISEL**

55-2010 10"

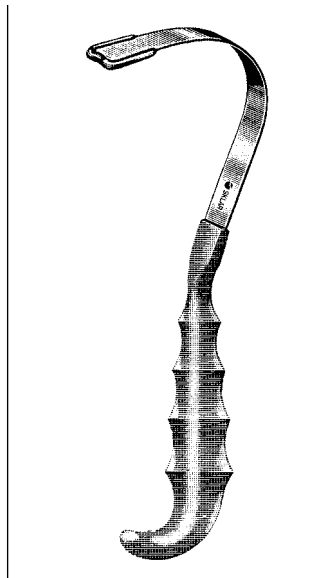


ZALKIND LUNG RETRACTOR

Malleable

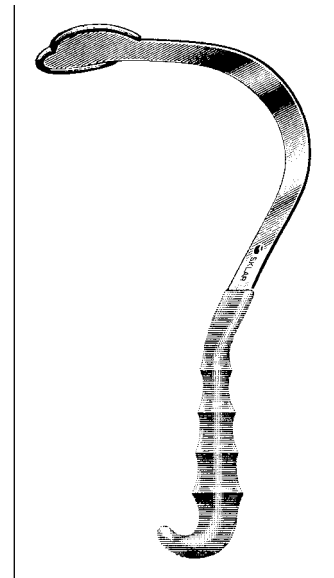
55-7220 2" x 12"

55-7230 3" x 12"



HARRINGTON RETRACTOR

22-7795 3/4" x 9 1/2" Pediatric

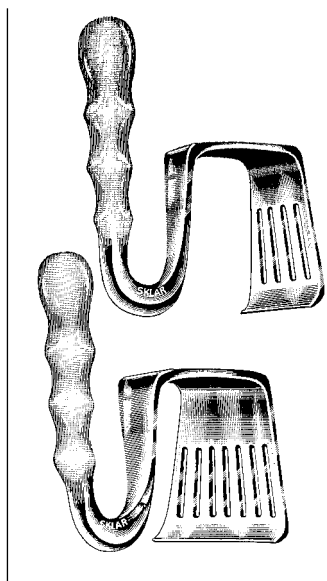


HARRINGTON SPLANCHNIC RETRACTOR

12" Long

55-7115 1 1/2" x 5" Blade

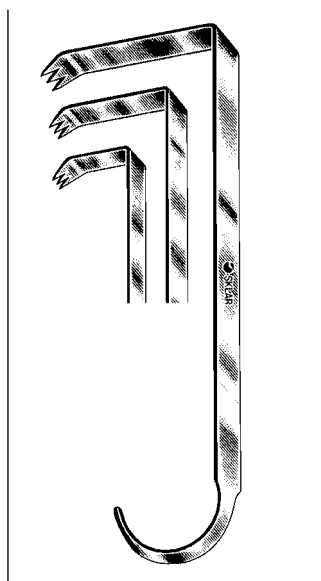
55-7125 2 1/2" x 5" Blade



DAVIDSON SCAPULA RETRACTOR

55-7195 Large 3" x 3 1/2"

55-7196 Small 3" x 2"

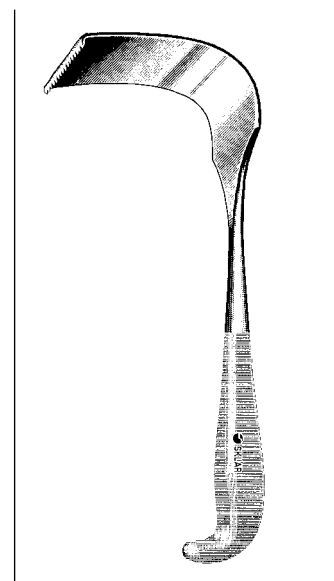


HIBBS RETRACTOR

55-7167 1/2" x 1 1/4" 6 3/4"

55-7175 5/8" x 2" 9"

55-7192 1" x 3" 9 1/2"

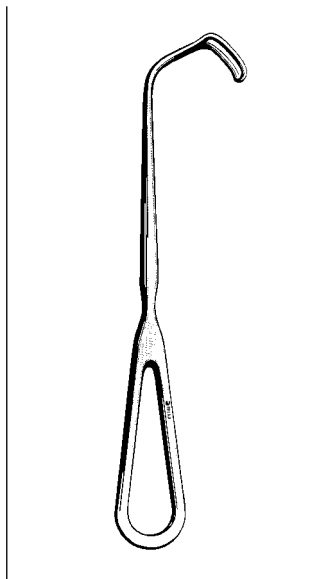


MEYERDING RETRACTOR

42-2085 7 3/4" Small 5/8" x 2" Blade

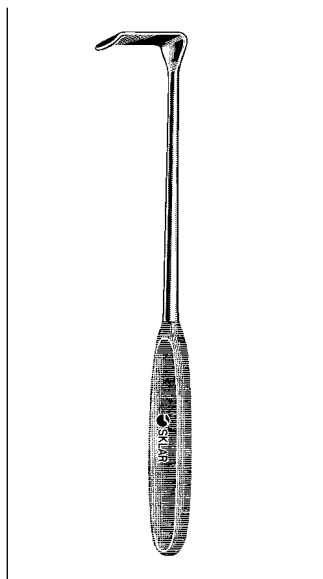
42-2092 8 3/4" Medium 1" x 3" Blade

42-2095 9 1/2" Large 2" x 3 1/2" Blade



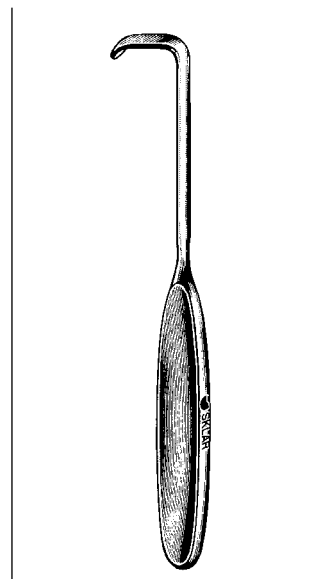
**SKLAR FENESTRATED
RETRACTOR**

50-1280 8"



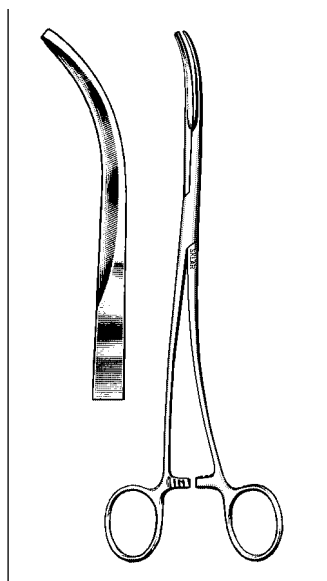
**LANGENBECK
RETRACTOR**

60-1891 $\frac{3}{8}$ " x $1\frac{1}{8}$ " 9"
60-1892 $\frac{1}{2}$ " x $1\frac{1}{4}$ " 9"
60-1891 $\frac{3}{8}$ " x $1\frac{1}{4}$ " 9"



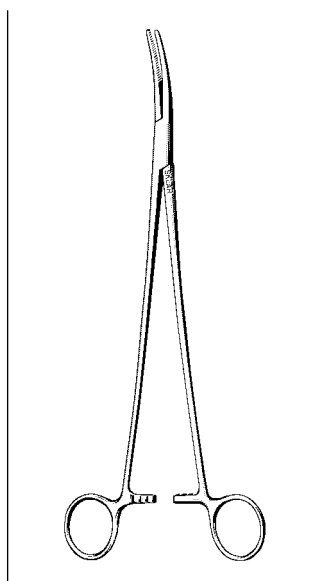
LAHEY RETRACTOR

52-1277 7"



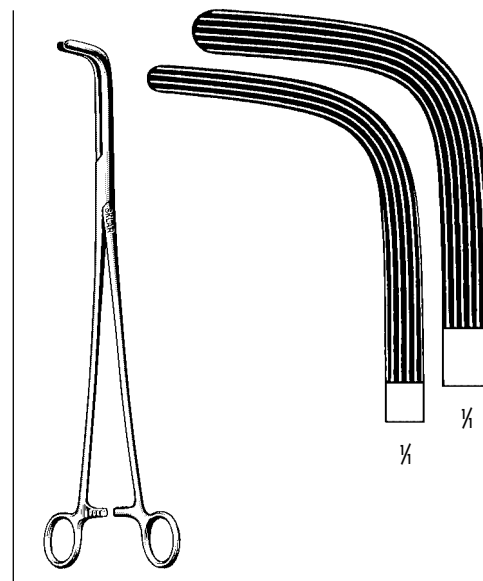
**SEMB DISSECTING
FORCEPS**

55-2395 Shallow Curve 9 $\frac{1}{2}$ "



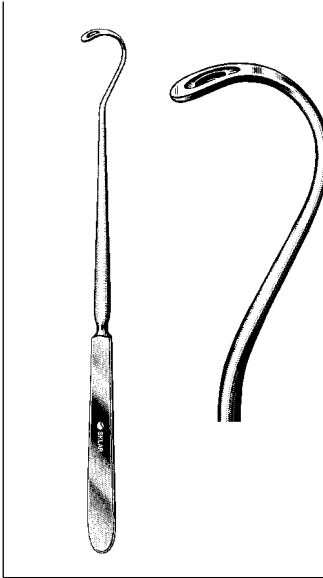
**SKLAR THORACIC
CLAMP**

55-3080 8" Curved
55-3110 10 $\frac{1}{4}$ " Curved



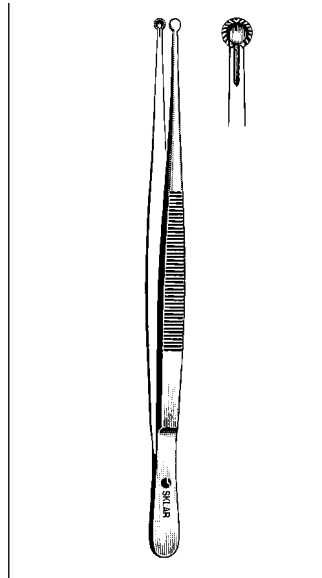
**HARRINGTON-MIXTER
CLAMP**

55-2912 12" Curved, Light Model
55-3012 12" Curved, Heavy Model



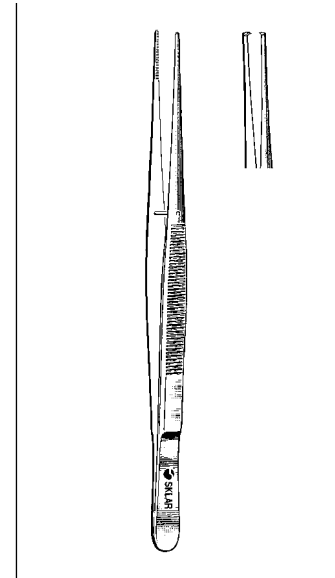
**NELSON LIGATURE
NEEDLE**

55-6492 9 1/4"



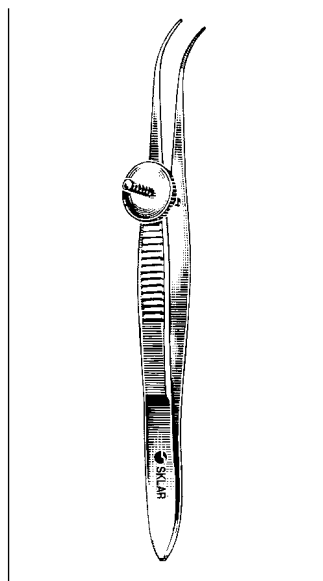
SELMAN FORCEPS

Non-Slip
52-4260 6"
52-4280 8"
52-4310 10"



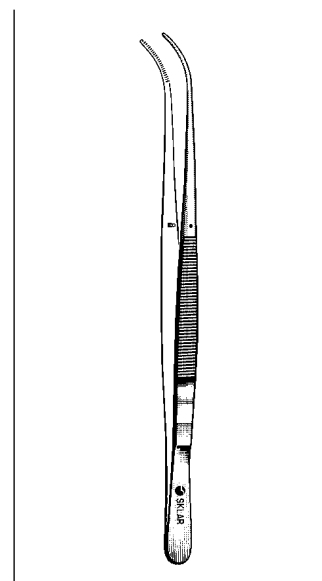
POTTS-SMITH FORCEPS

52-3270	7"	Serrated
52-3282	8 1/4"	Serrated
52-3370	7"	1 x 2
52-3382	8 1/4"	1 x 2
52-3310	10"	Serrated
52-3410	10"	1 x 2



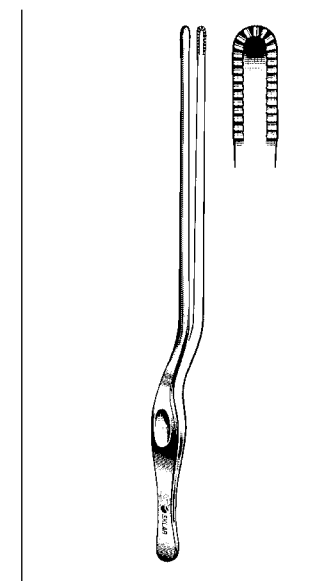
**GORDON CATHETER
INTRODUCING FORCEPS**

52-3240 4" Half Curved, Serrated



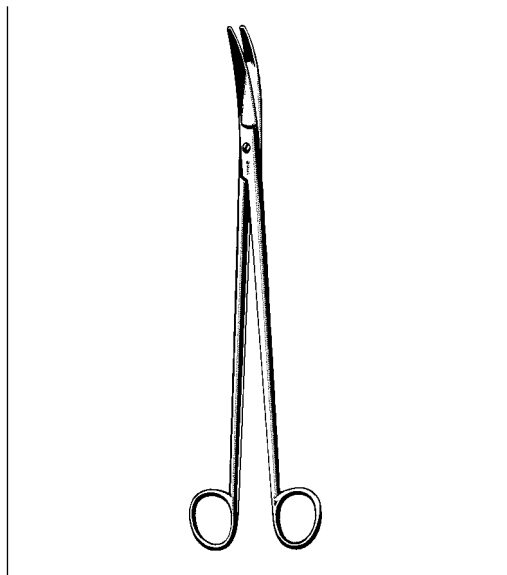
**KANTROWITZ TISSUE
FORCEPS**

52-3597 9 3/4" Curved, 1 x 2



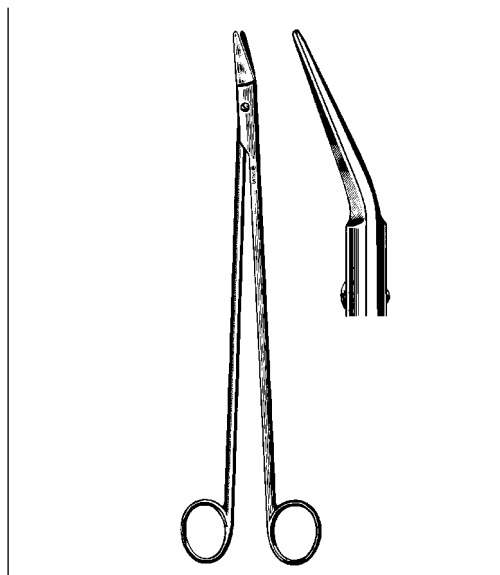
**HARRINGTON-MAYO
BAYONET TISSUE FORCEPS**

55-4114 14"



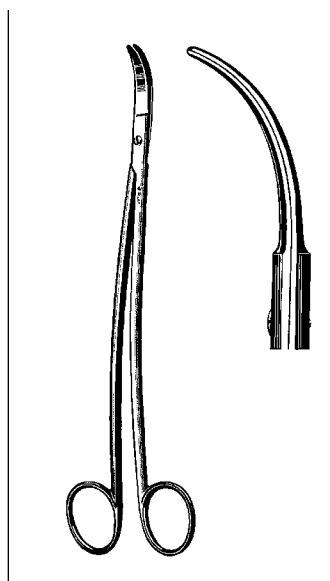
MAYO DISSECTING SCISSORS

Straight Curved
55-8711 11" 55-8611 11"



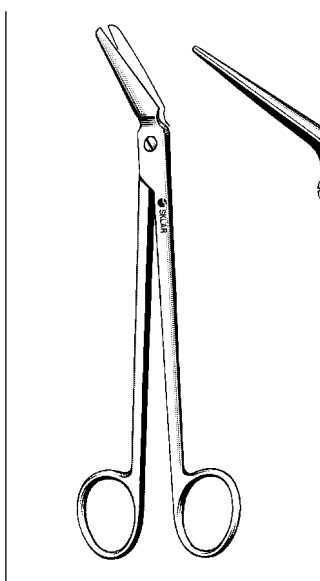
FINOCHIETTO SCISSORS

Thoracic Scissors, Angular
55-8310 10 3/4"



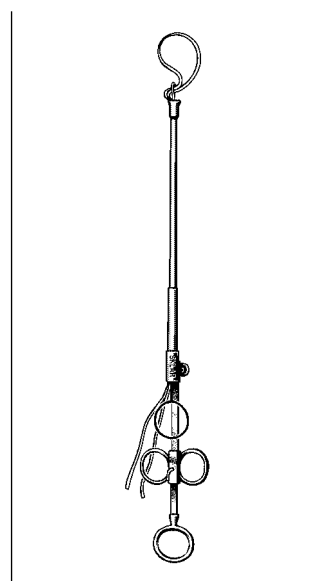
SATINSKY SCISSORS

Double Curve
55-8495 9 1/2"



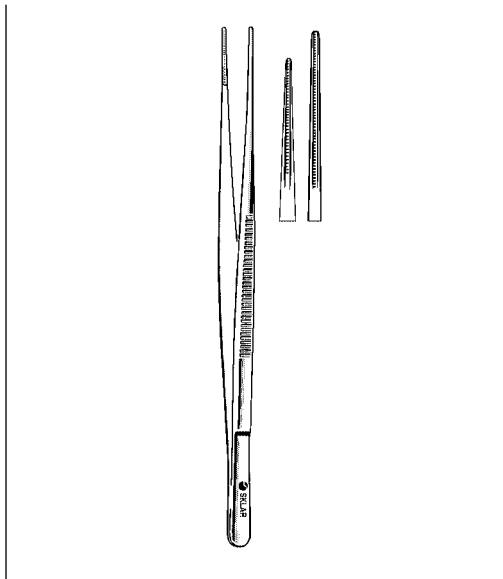
SWEET SCISSORS 45° ANGLE

55-8380 8"



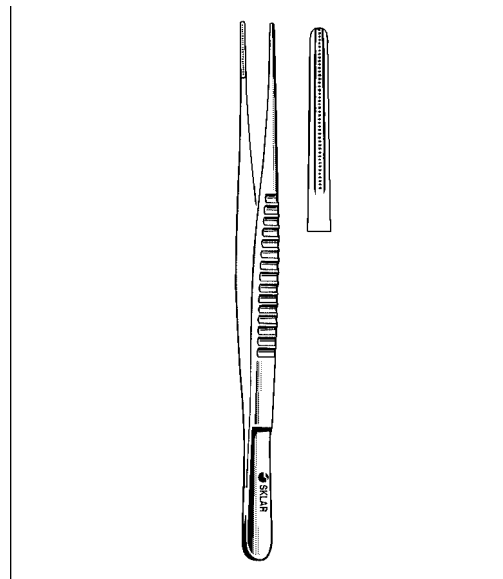
RUMEL TOURNIQUET

Complete with threading stylet
52-4113 13"



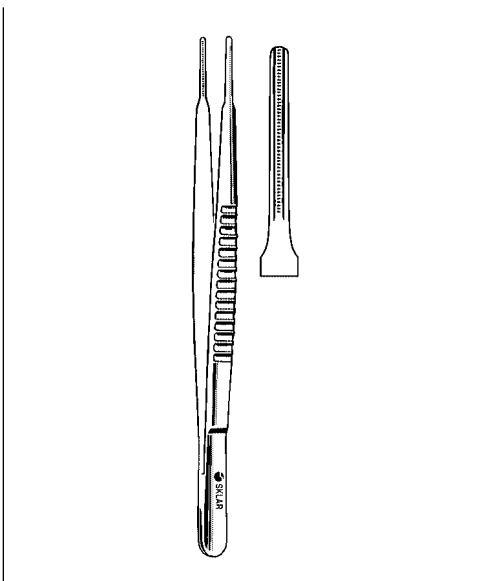
DEBAKEY ATRAUMATIC TISSUE FORCEPS

1.5 mm jaws
 52-5062 6¼"
 52-5077 7¼"
 52-5095 9½"



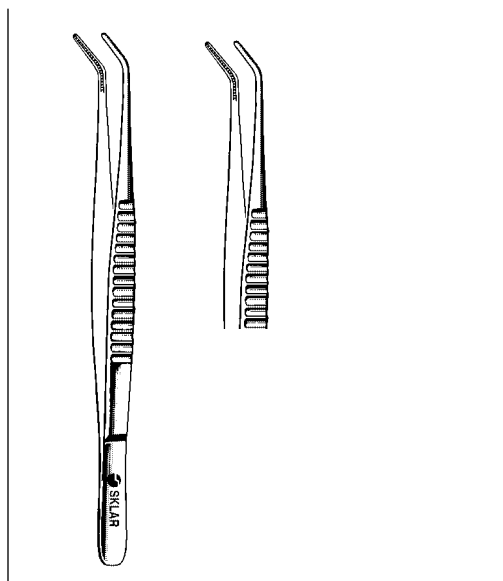
DEBAKEY ATRAUMATIC TISSUE FORCEPS

2.0 mm jaws
 52-5162 6¼"
 52-5177 7¼"
 52-5195 9½"



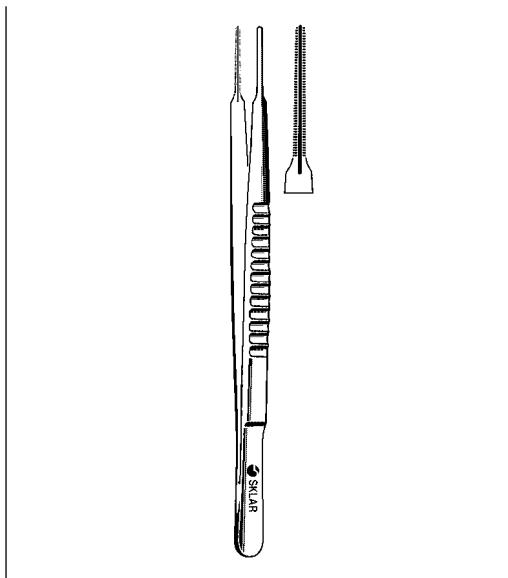
DEBAKEY ATRAUMATIC TISSUE FORCEPS

3.5 mm jaws
 52-5262 6¼"
 52-5277 7¼"
 52-5295 9½"



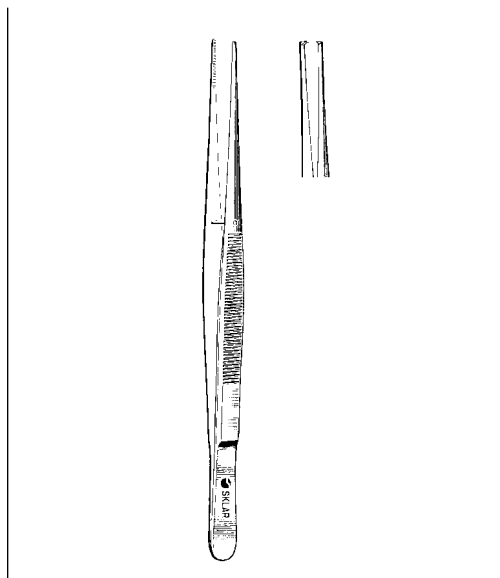
DEBAKEY ATRAUMATIC TISSUE FORCEPS

52-5306	6¼"	2 mm
52-5307	7¼"	2 mm
52-5309	9½"	2.5 mm
52-5312	12"	2.5 mm



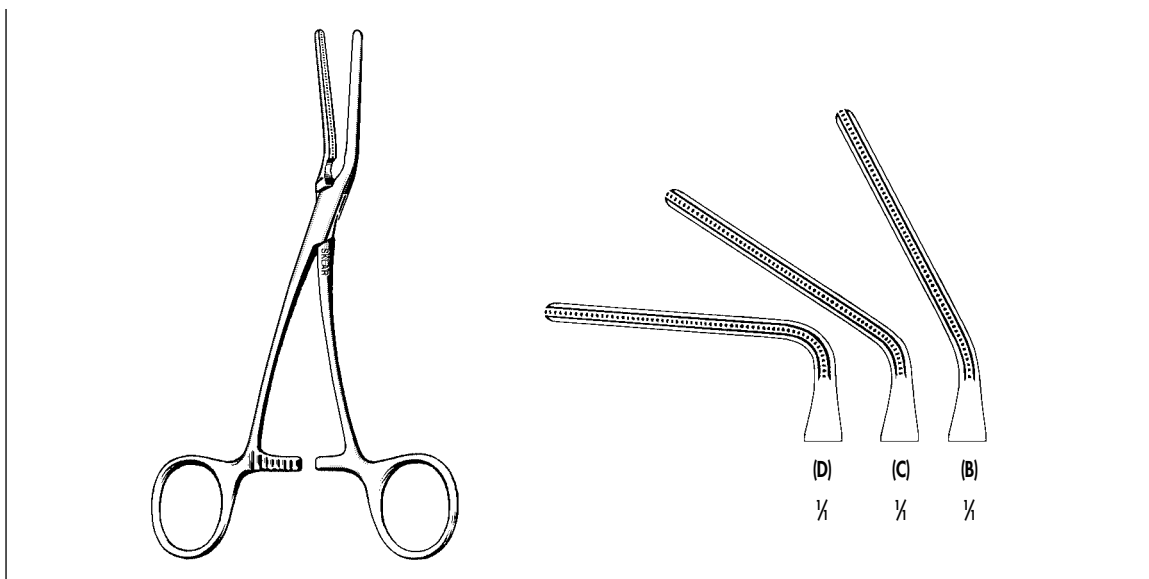
COOLEY VASCULAR TISSUE FORCEPS

- 52-6690 6"
- 52-6694 8"
- 52-6696 9½"



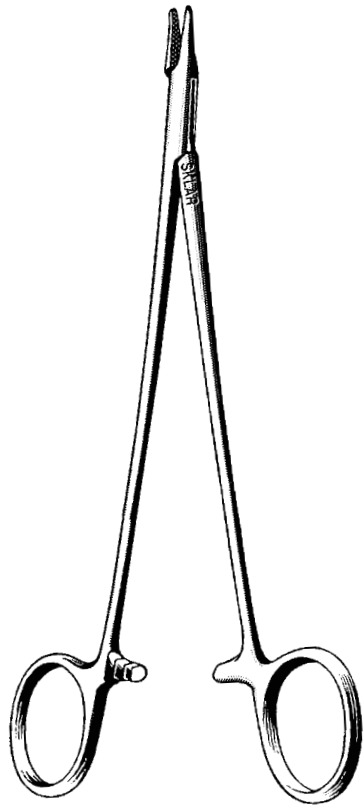
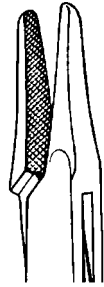
POTTS-SMITH FORCEPS

- 52-3270 7" Serrated
- 52-3282 8¼" Serrated
- 52-3370 7" 1 x 2
- 52-3382 8¼" 1 x 2
- 52-3310 10" Serrated
- 52-3410 10" 1 x 2



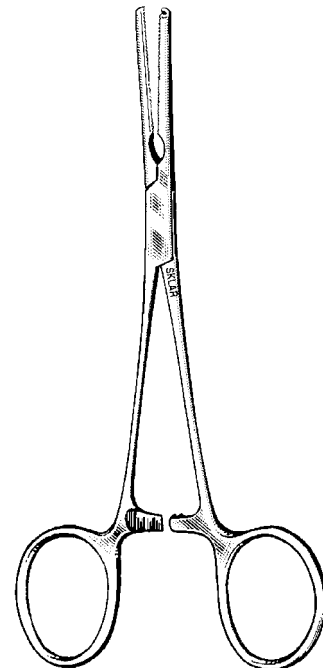
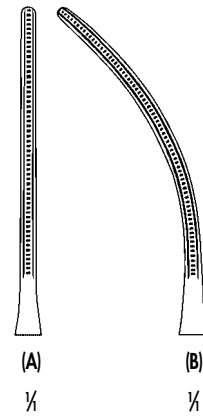
DEBAKEY ATRAUMATIC TISSUE FORCEPS

- 52-6585 Pediatric Straight 5½"
- 52-6587 Pediatric Angular 30° 5½" (B)
- 52-6588 Pediatric Angular 60° 5½" (C)
- 52-6589 Pediatric Angular 90° 5½" (D)



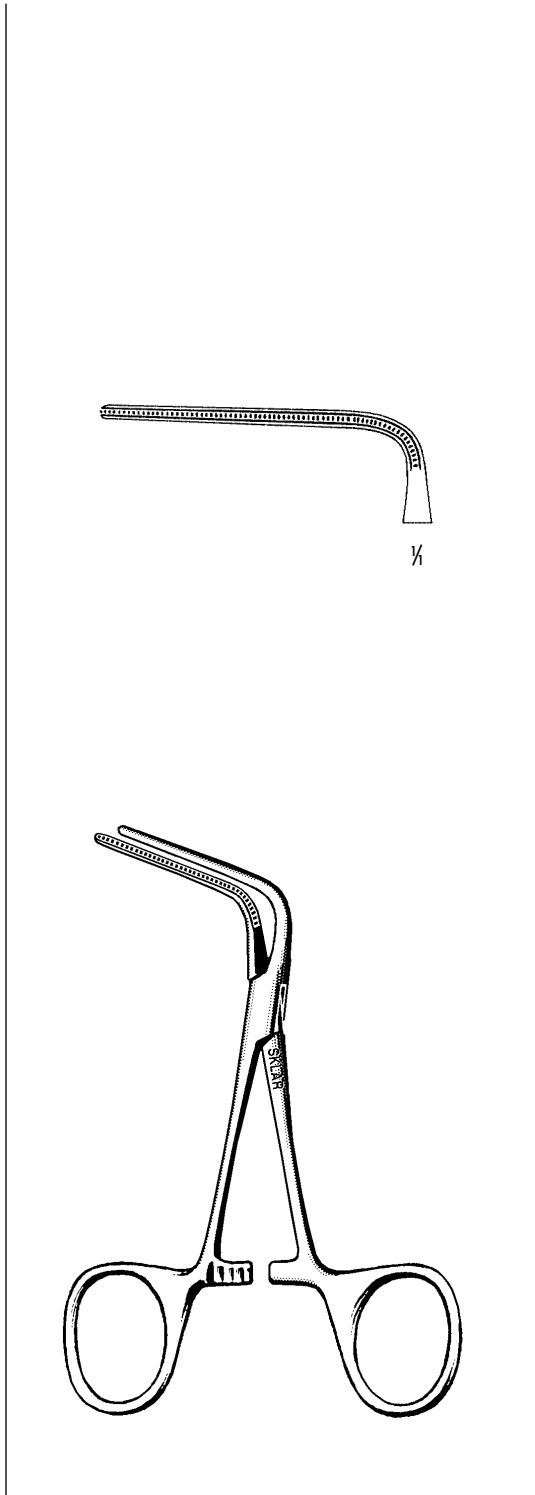
LEMMON VASCULAR NEEDLE HOLDER

20-4175 6³/₄"
20-4178 7³/₄"



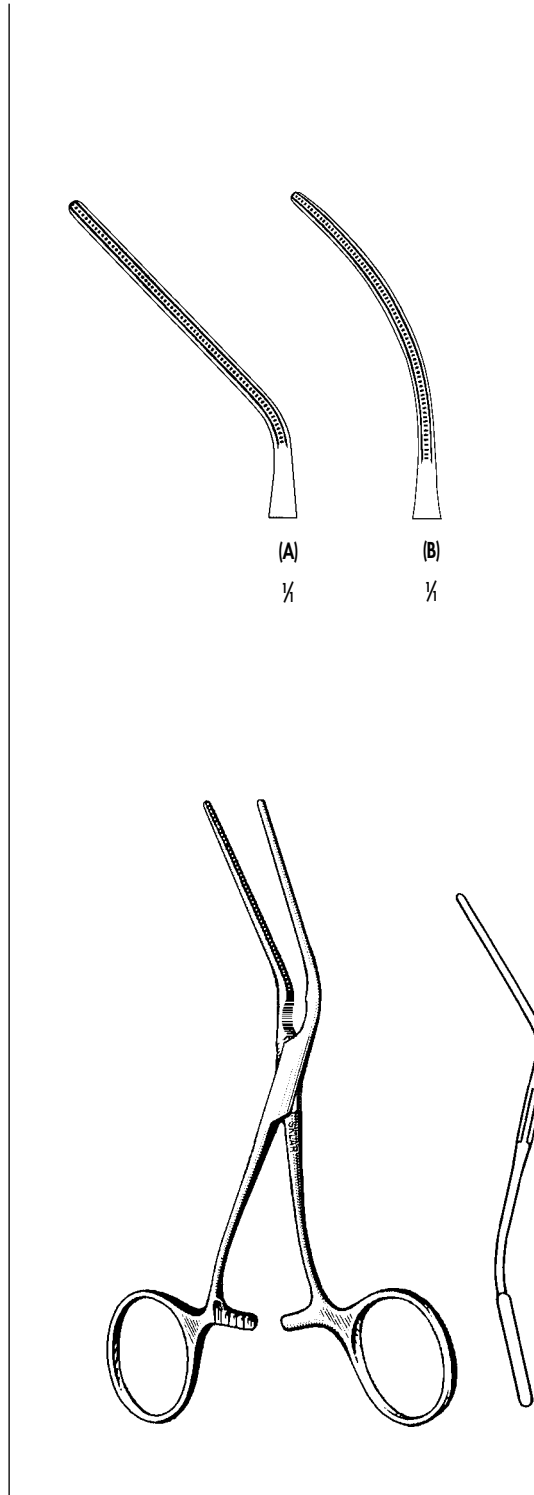
DEBAKEY ATRAUMATIC VASCULAR TISSUE FORCEPS

52-6575 Ring Handle Bulldog Straight 5" (A)
52-6577 Ring Handle Bulldog Curved 5" (B)



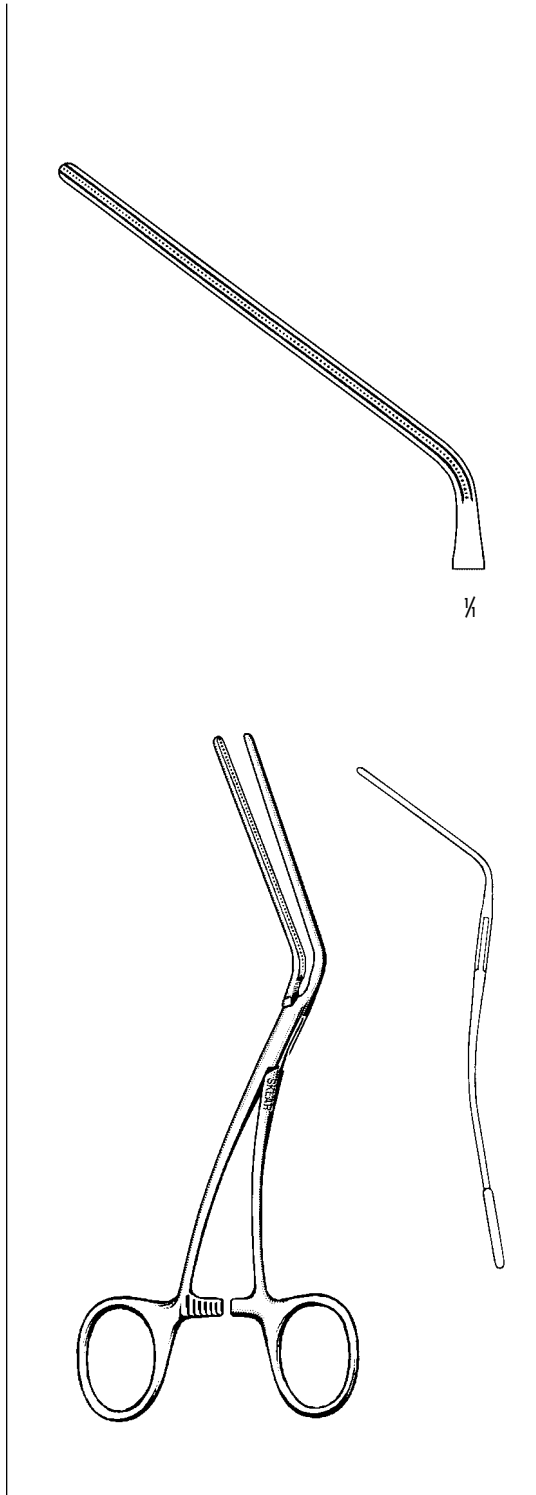
DEBAKEY ATRAUMATIC VASCULAR FORCEPS

52-6579 Ring Handle Bulldog 90° Angle 5"



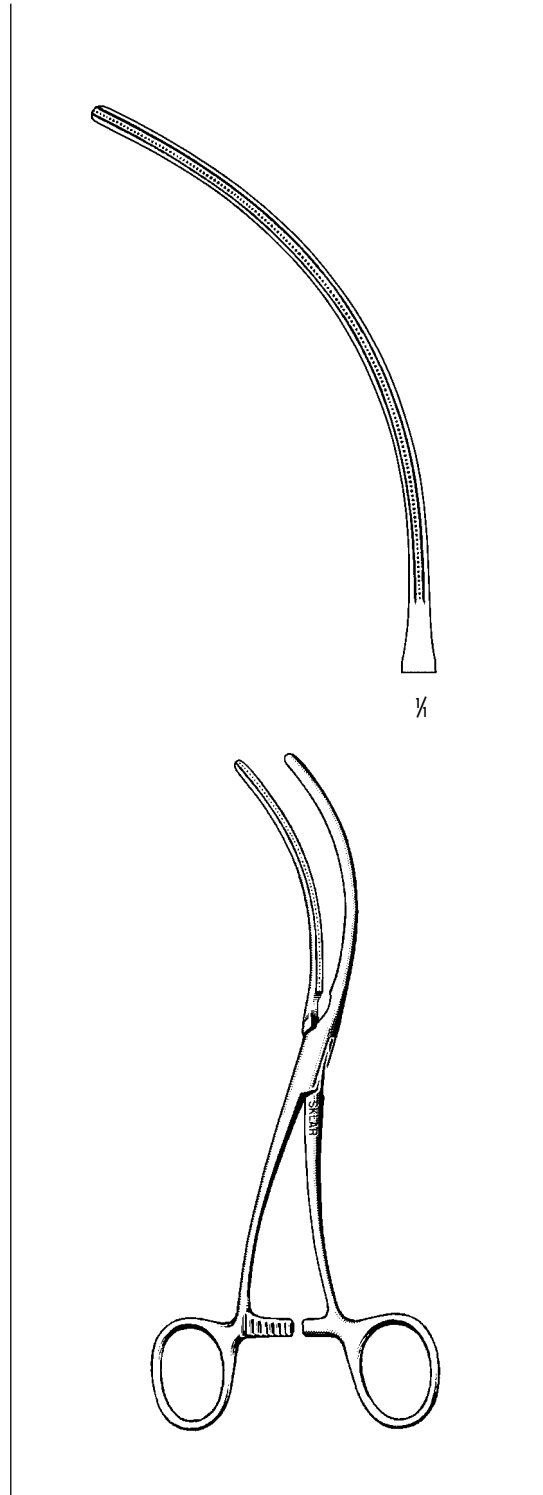
DEBAKEY ATRAUMATIC VASCULAR FORCEPS

52-6580 Ring Handle Bulldog 45° Angle 4 1/4" (A)
52-6582 Ring Handle Bulldog S Curved 5" (B)



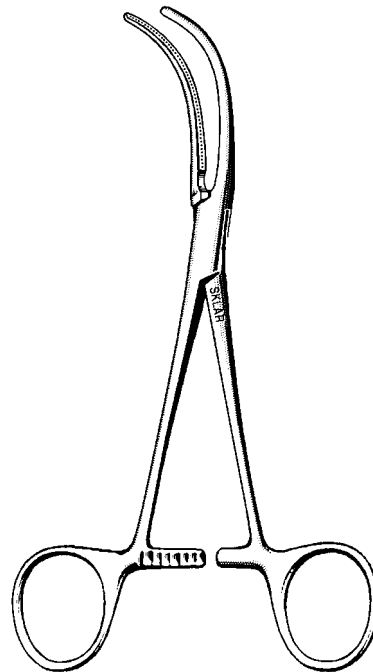
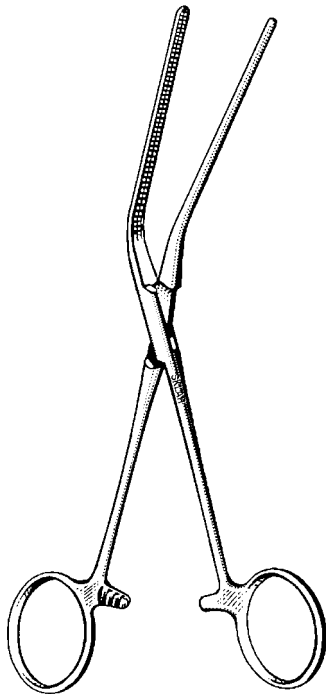
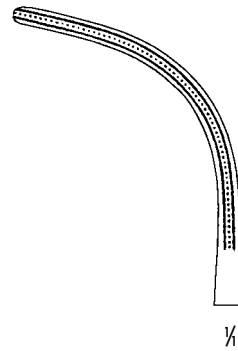
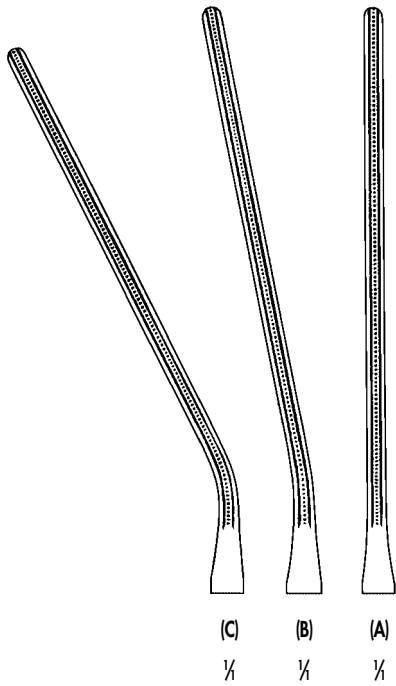
DEBAKEY ATRAUMATIC PERIPHERAL VESSEL FORCEPS

52-6600 Jaw Length 65 mm 7"



DEBAKEY PERIPHERAL VASCULAR CLAMP

52-6603 8" S Shaped



DEBAKEY ATRAUMATIC FORCEPS

Leland Jones Pattern

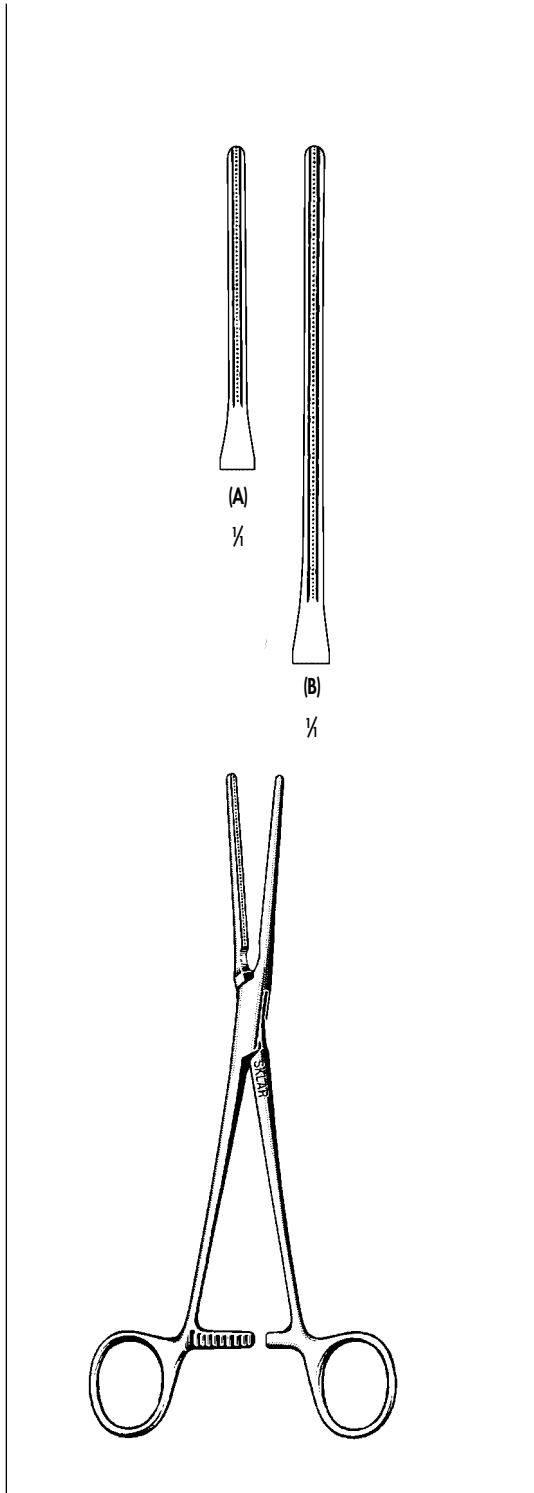
52-6655 Straight 7 1/2" (A)

52-6657 15° Angle 7 1/2" (B)

52-6659 30° Angle 7 1/2" (C)

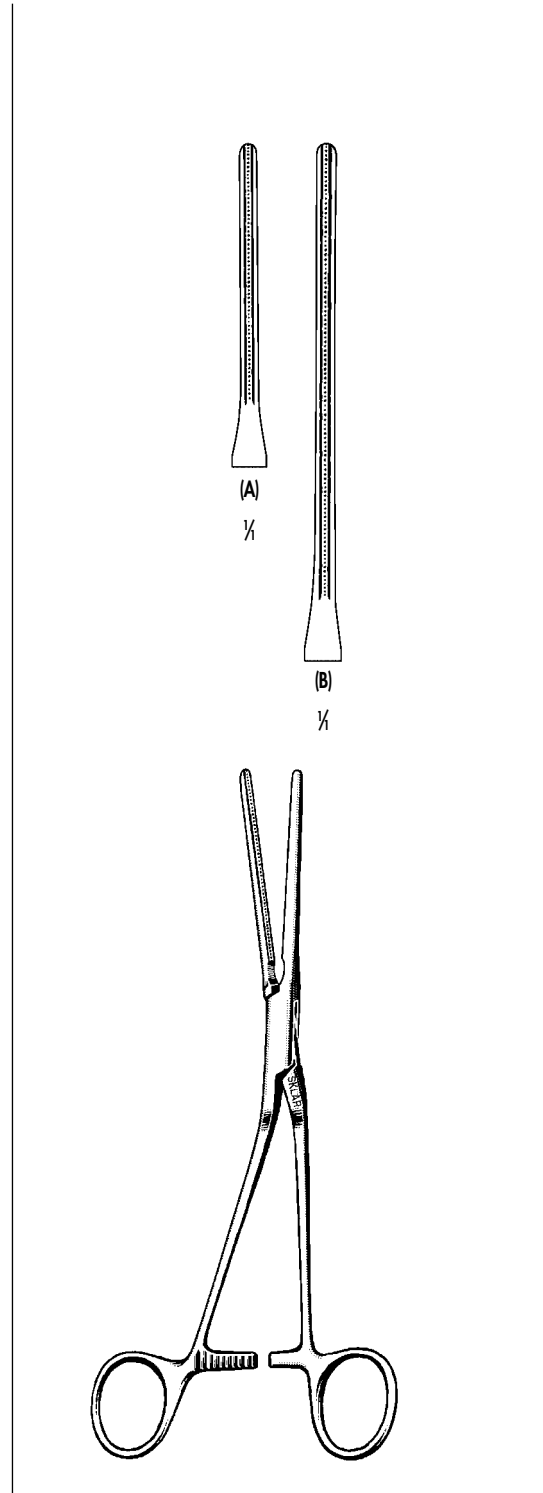
DEBAKEY ATRAUMATIC FORCEPS

52-6602 6" Full curve with straight handle



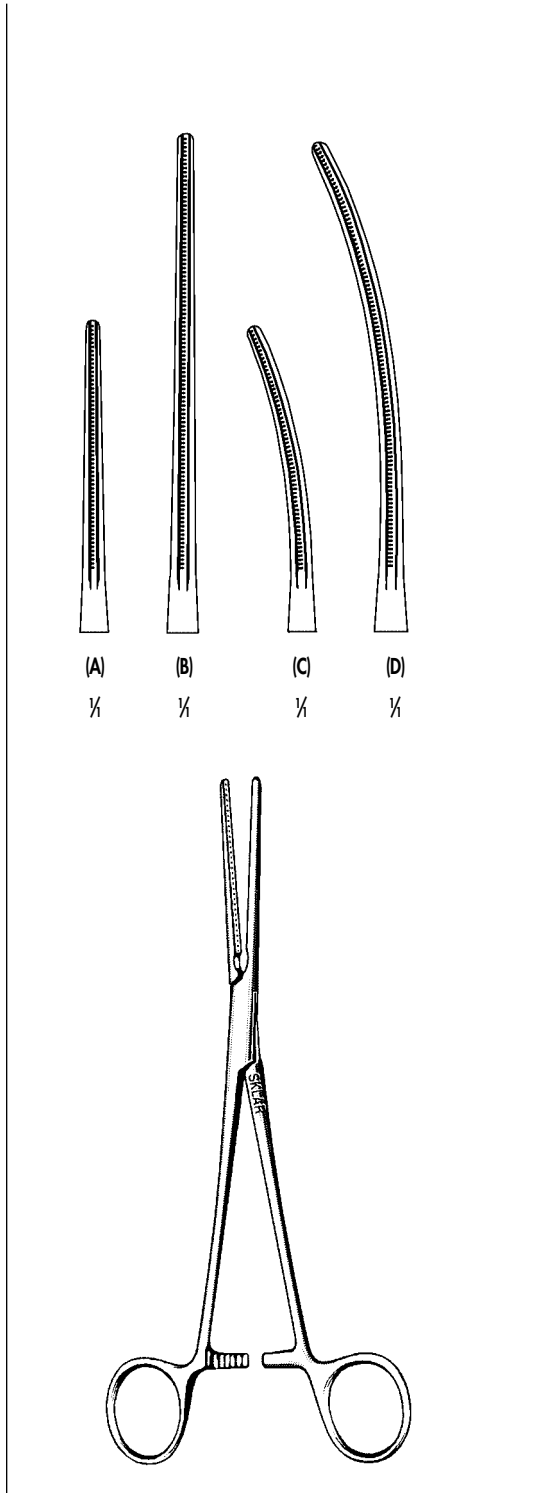
DEBAKEY ATRAUMATIC FORCEPS

- 52-6590 Patent Ductus Straight 8 1/4" (A)
- 52-6594 Coarctation Straight 8 3/4" (B)



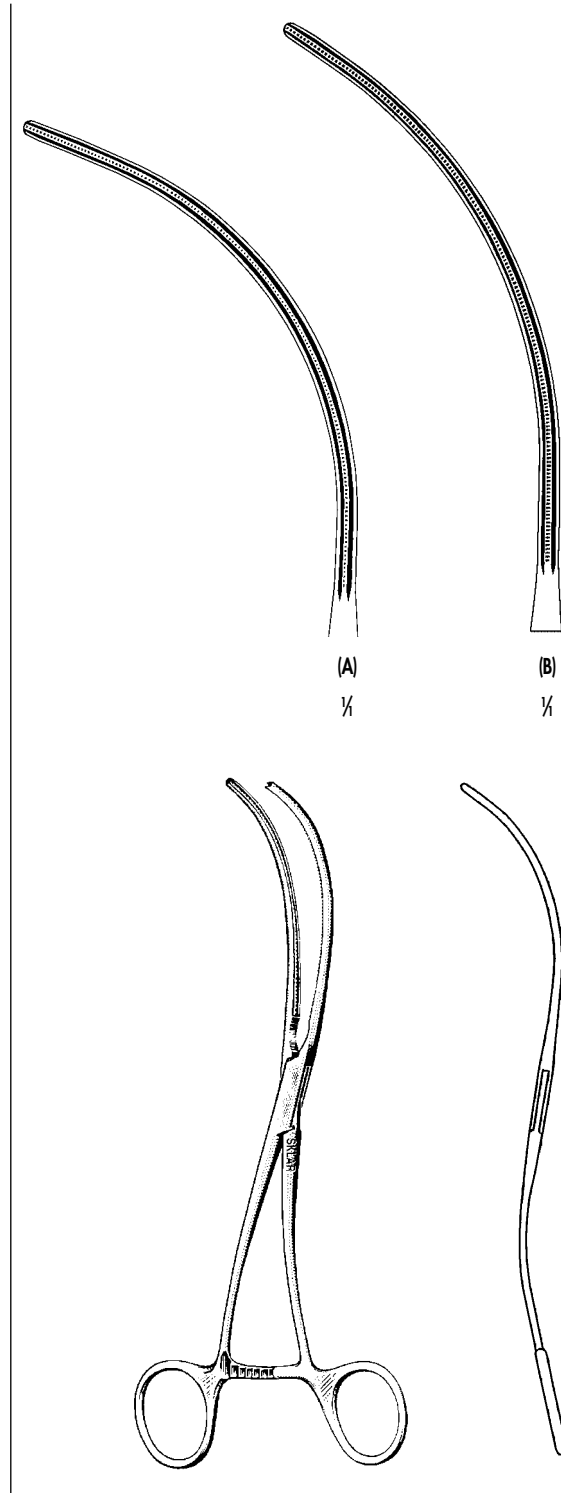
DEBAKEY ATRAUMATIC FORCEPS

- 52-6592 Patent Ductus Angular 8 1/4" (A)
- 52-6596 Coarctation Angular 8 3/4" (B)



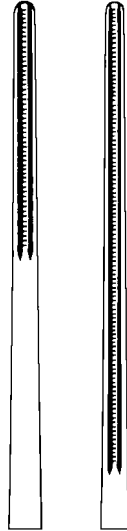
DEBAKEY BAINBRIDGE VASCULAR FORCEPS

- 52-6700 6" Straight (A)
- 52-6702 7" Straight (B)
- 52-6704 6" Curved (C)
- 52-6706 7" Curved (D)

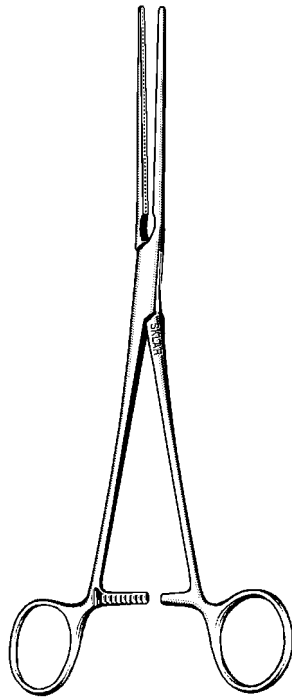


DEBAKEY ATRAUMATIC PERIPHERAL VESSEL FORCEPS

- 52-6604 S Curve Acute 85 mm Jaw 7 1/2" (A)
- 52-6605 S Curve 85 mm Jaw 8" (B)



(A) 1/2
(B) 1/2

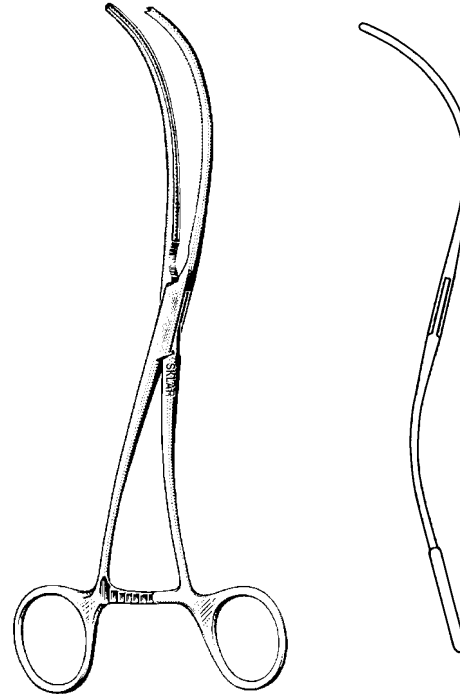


GLOVER FORCEPS

52-1980 Patent Ductus Straight 8 1/2" (A)
52-2082 Coarctation Straight 8 3/4" (B)

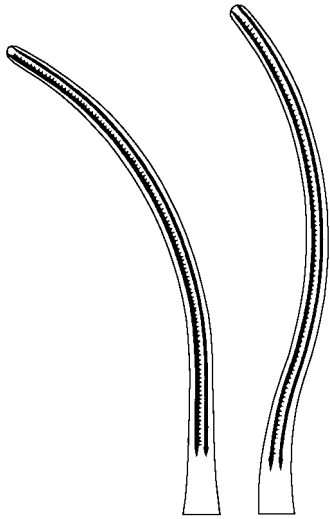


(A) 1/2
(B) 1/2

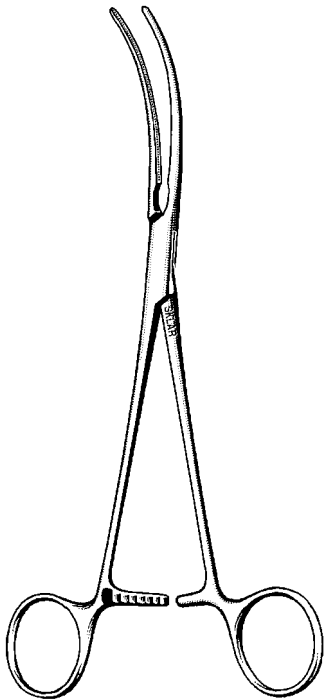


GLOVER FORCEPS

52-1975 Patent Ductus Angular 8 1/2" (A)
52-2080 Coarctation Angular 8 3/4" (B)

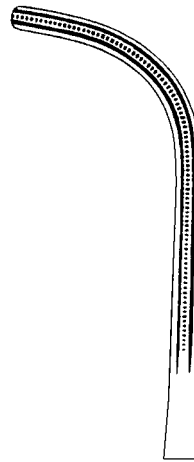


(A) 1/2
(B) 1/2

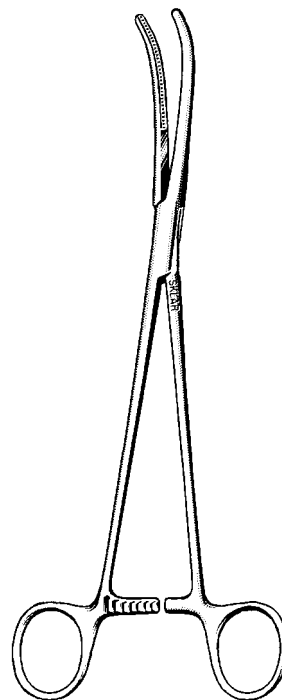


GLOVER FORCEPS

52-2178 Curved 8 3/4" (A)
52-2180 Spoon-Shaped 8 3/4" (B)

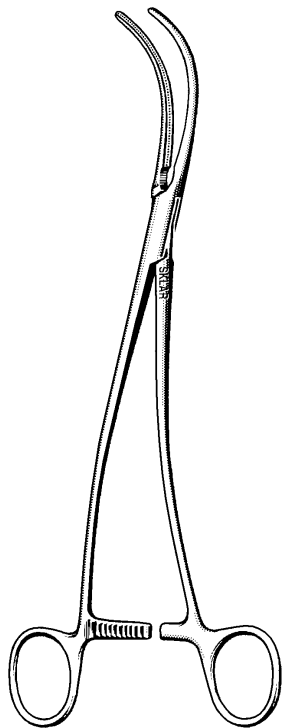
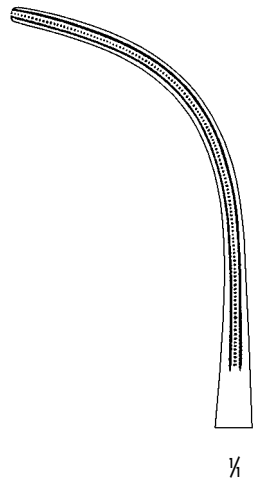


1/2



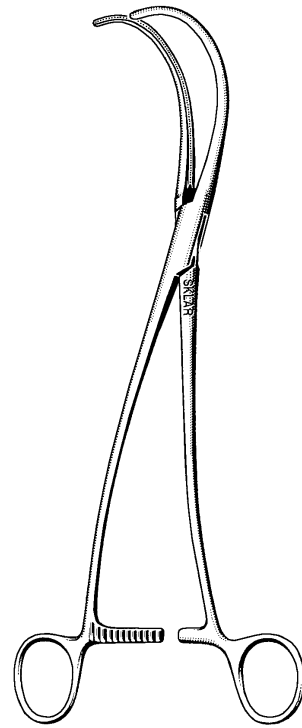
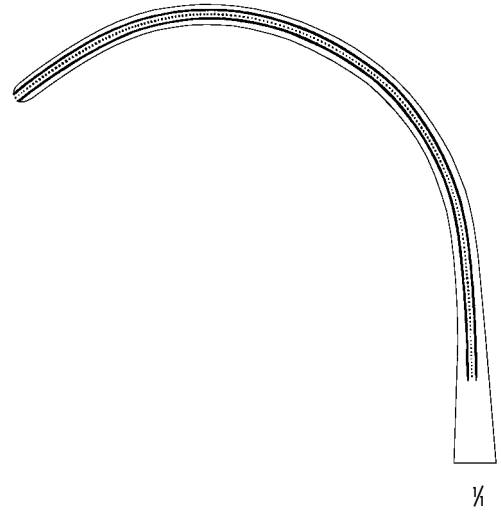
DEBAKEY-RUMEL CLAMP

52-6724 9 1/2" Full Curve #4



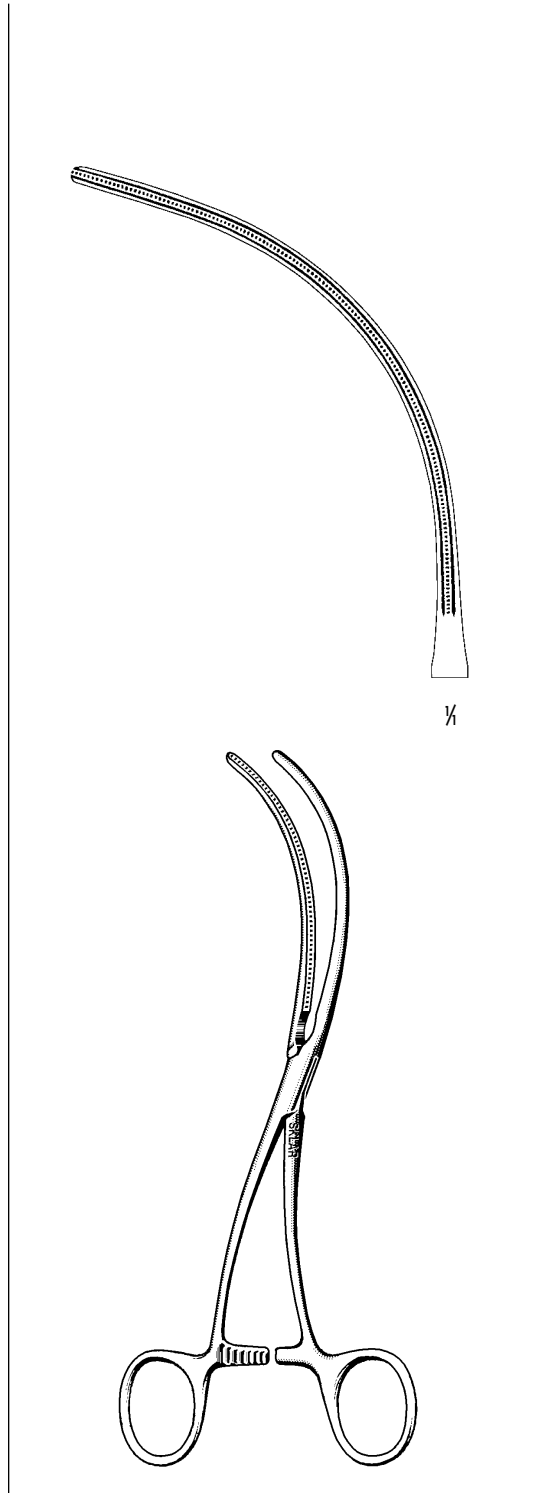
DEBAKEY VASCULAR CLAMP

52-6732 Full Curved 9½"



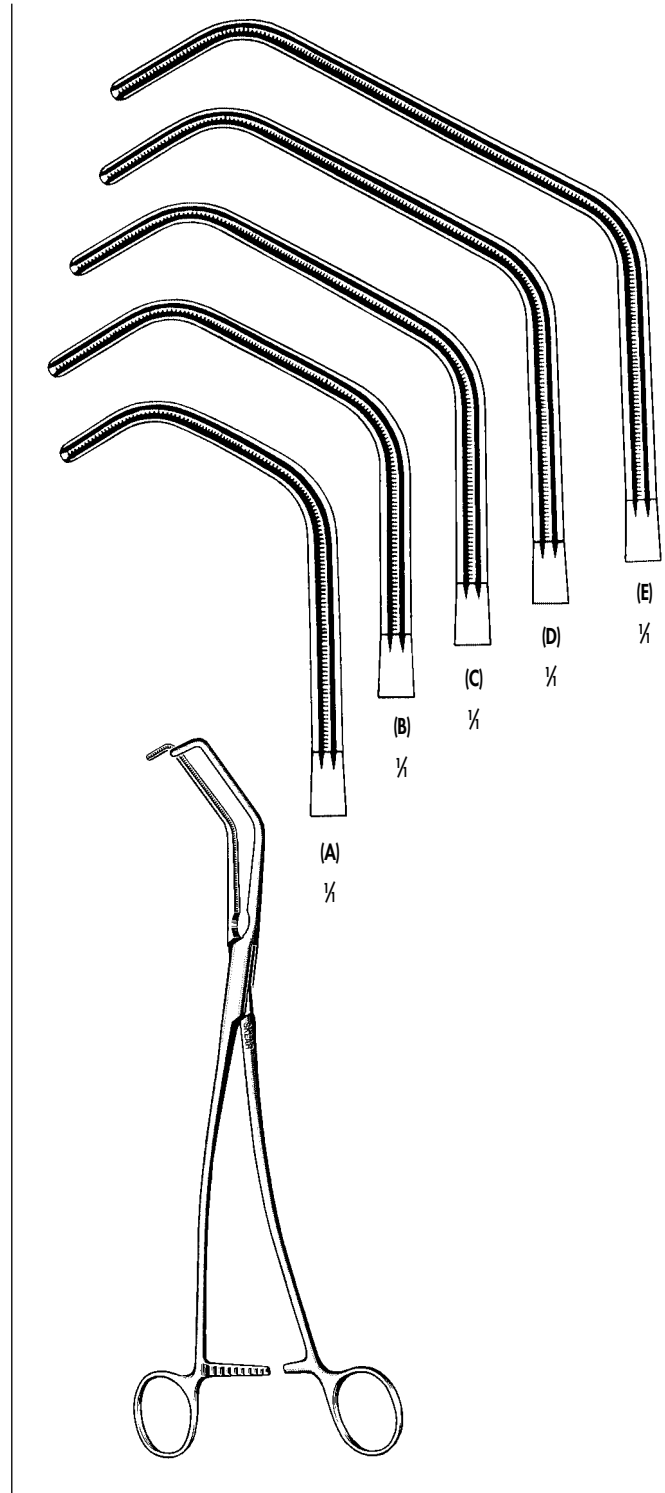
DEBAKEY VASCULAR CLAMP

52-6730 Acutely Curved, Extra Large 10"
Jaw Length 9.5 cm



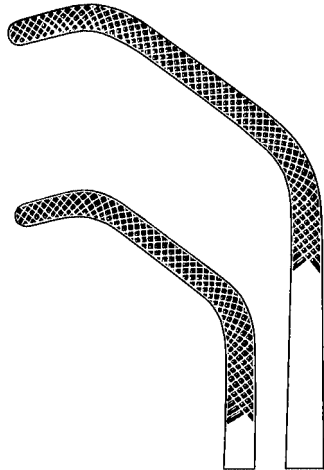
DEBAKEY AORTIC EXCLUSION CLAMP

52-6601 Acute S-Shaped 7 1/4"

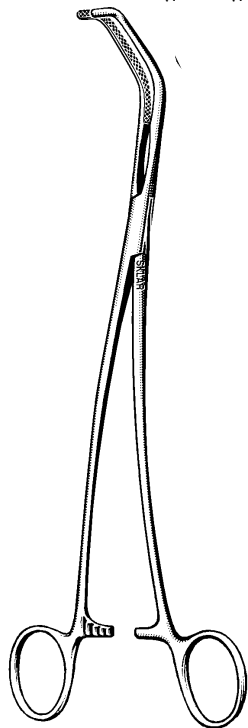


DEBAKEY TANGENTIAL OCCLUSION

- 52-6620 8" (A)
- 52-6622 9 1/4" (B)
- 52-6624 10" (C)
- 52-6626 10 1/2" (D)
- 52-6628 10 3/4" (E)

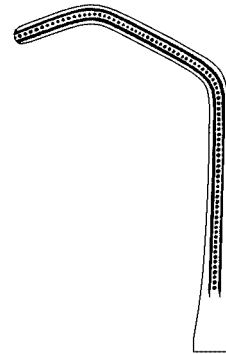


(A) 1/4
(B) 1/4

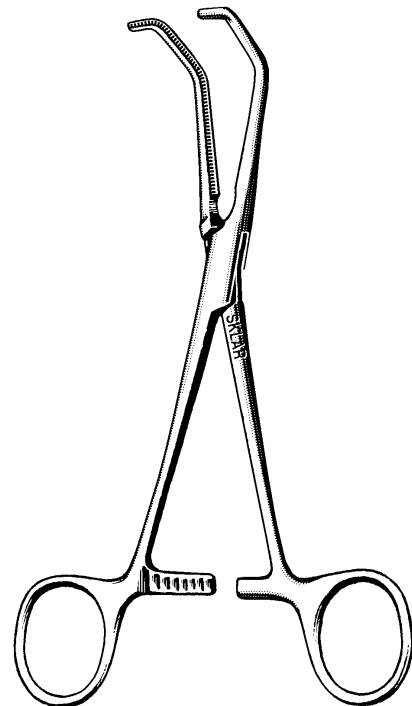


SATINSKY VENA CAVA CLAMP

52-1595 9 1/4" Cross Serrations (A)
52-1695 10 1/4" Cross Serrations (B)

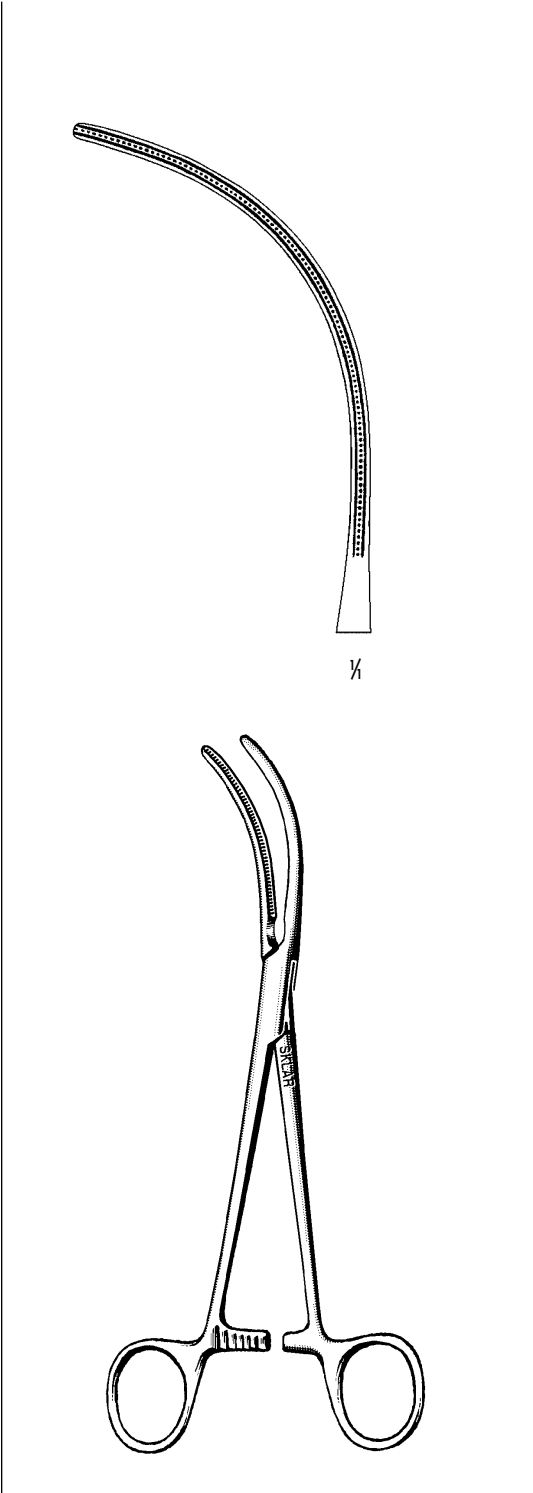


1/4



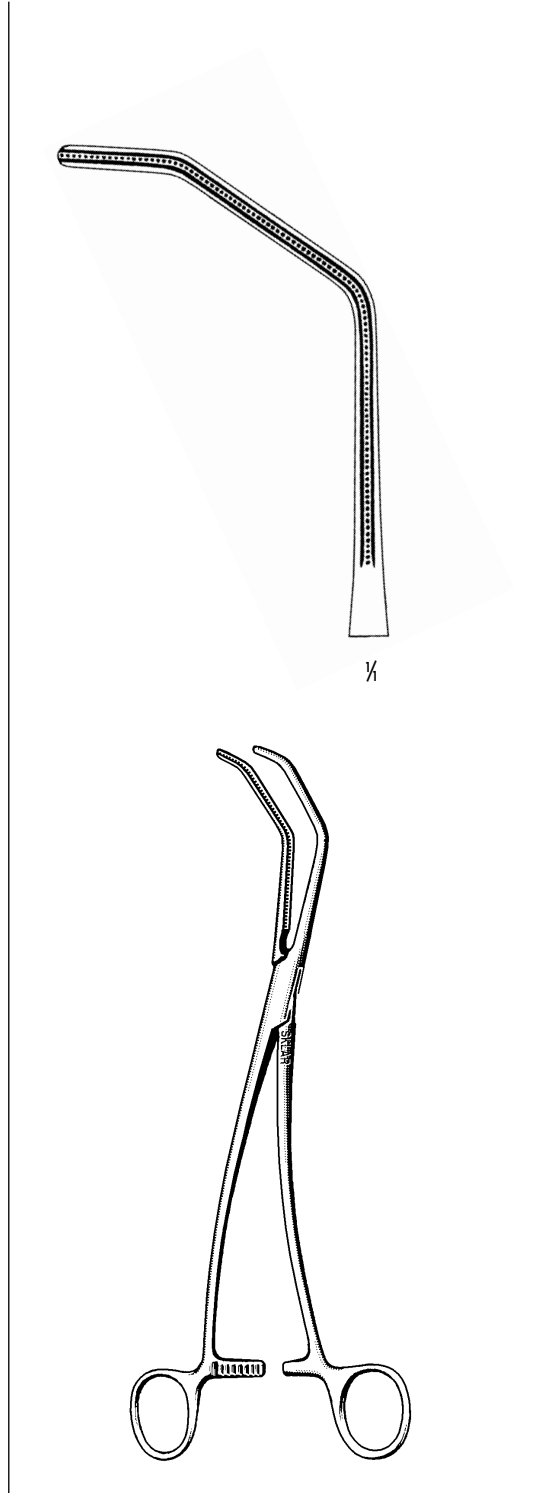
DEBAKEY-BECK AORTIC CLAMP

52-6745 6 1/2" Pediatric



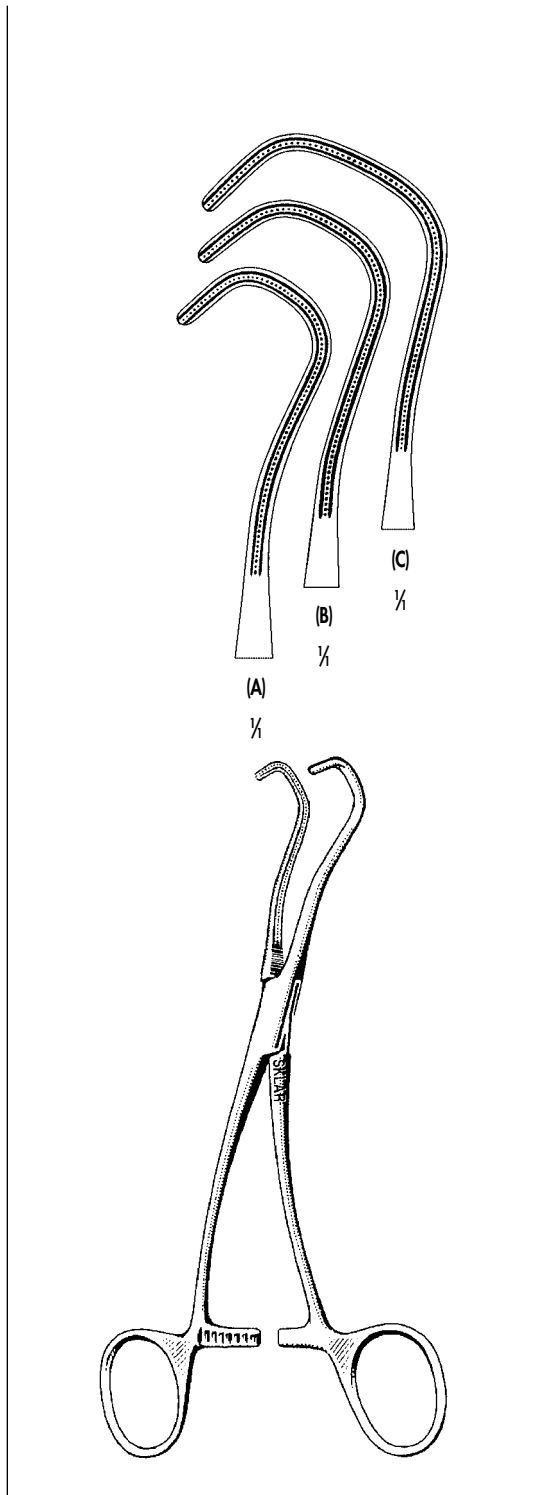
GLOVER CURVED CLAMP

52-6750 9 1/2"



GLOVER ANASTOMOSIS CLAMP

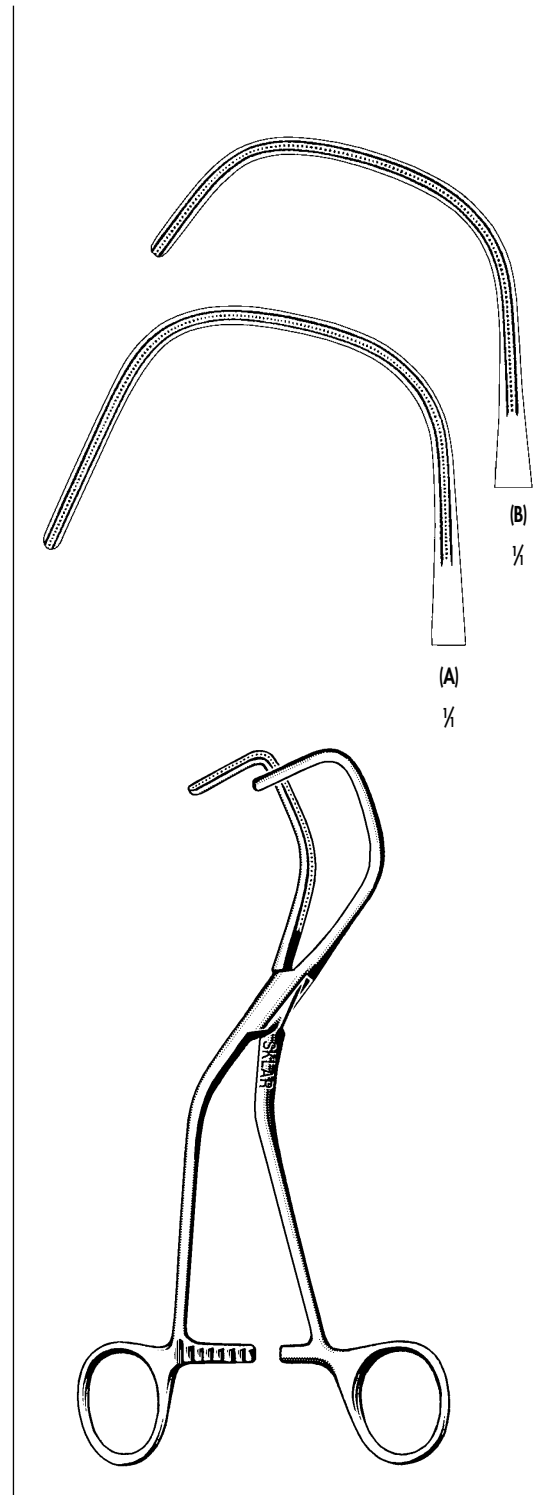
52-6760 9 1/4"



DEBAKEY-DERRA ATRAUMATIC FORCEPS

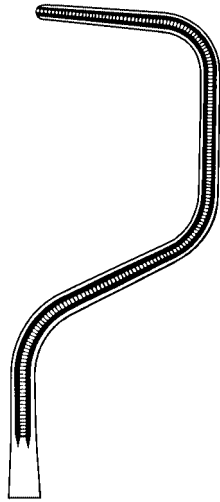
Anastomosis

- 52-6650 Small 6 1/4" (A)
- 52-6652 Medium 6 3/4" (B)
- 52-6654 Large 7" (C)

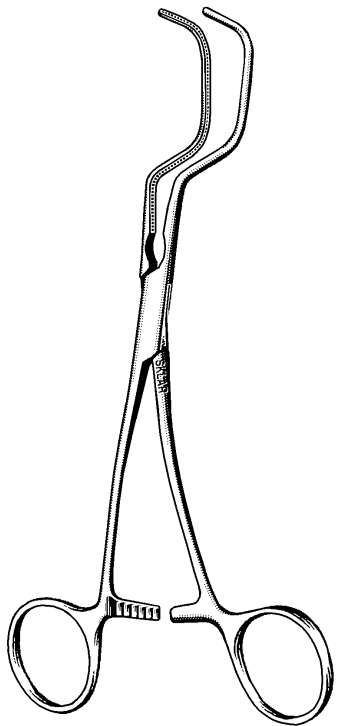


KAY AORTA CLAMP

- 52-6775 8" Jaw Length 4.5 cm Depth 3.2 cm (A)
- 52-6778 8" Lambert-Kay Aorta Clamp
Jaw Length 4.5 cm Depth 1.9 cm (B)

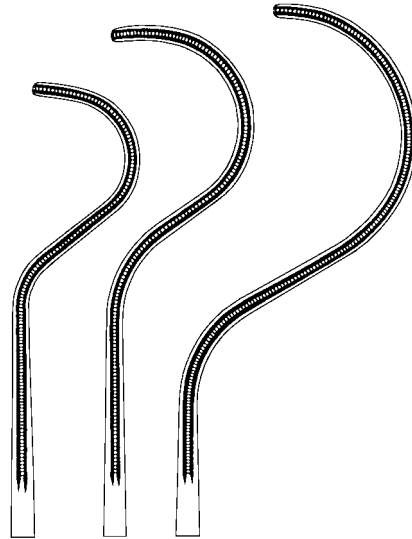


1/4



DALE ATRAUMATIC CARDIOVASCULAR FORCEPS

52-6785 7"



(A)

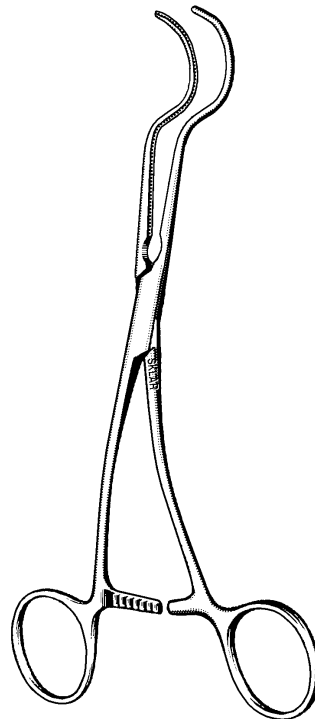
(B)

(C)

1/4

1/4

1/4

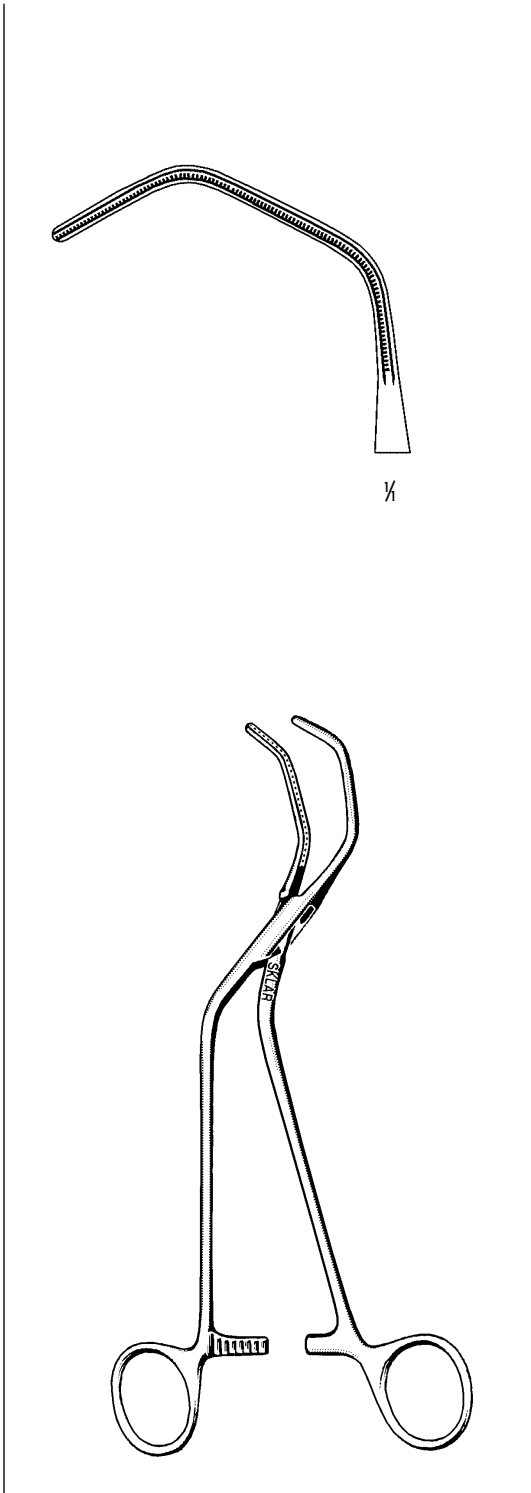


DALE ATRAUMATIC CARDIOVASCULAR FORCEPS

52-6790 6 1/2" (A)

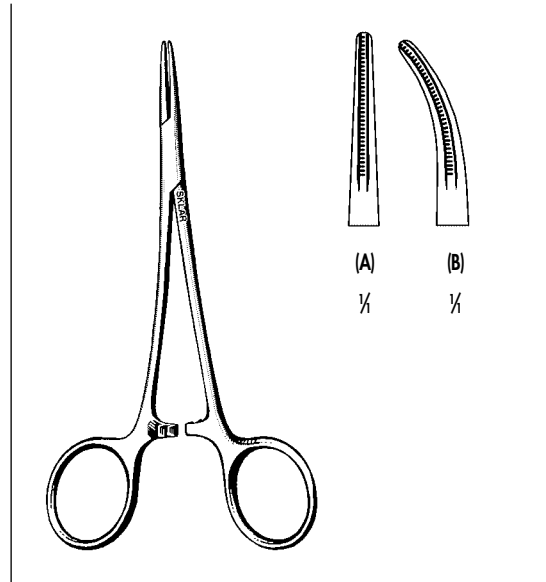
52-6792 7" (B)

52-6794 7 1/4" (C)



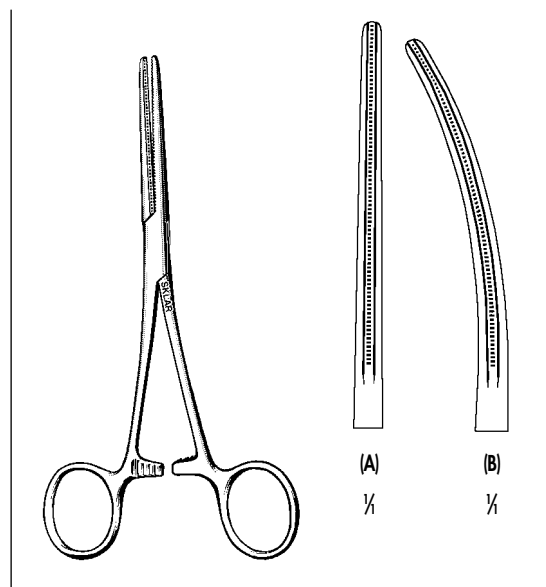
DIETRICH AORTA CLAMP

52-6780 8 1/4" Jaw Length 4.7cm



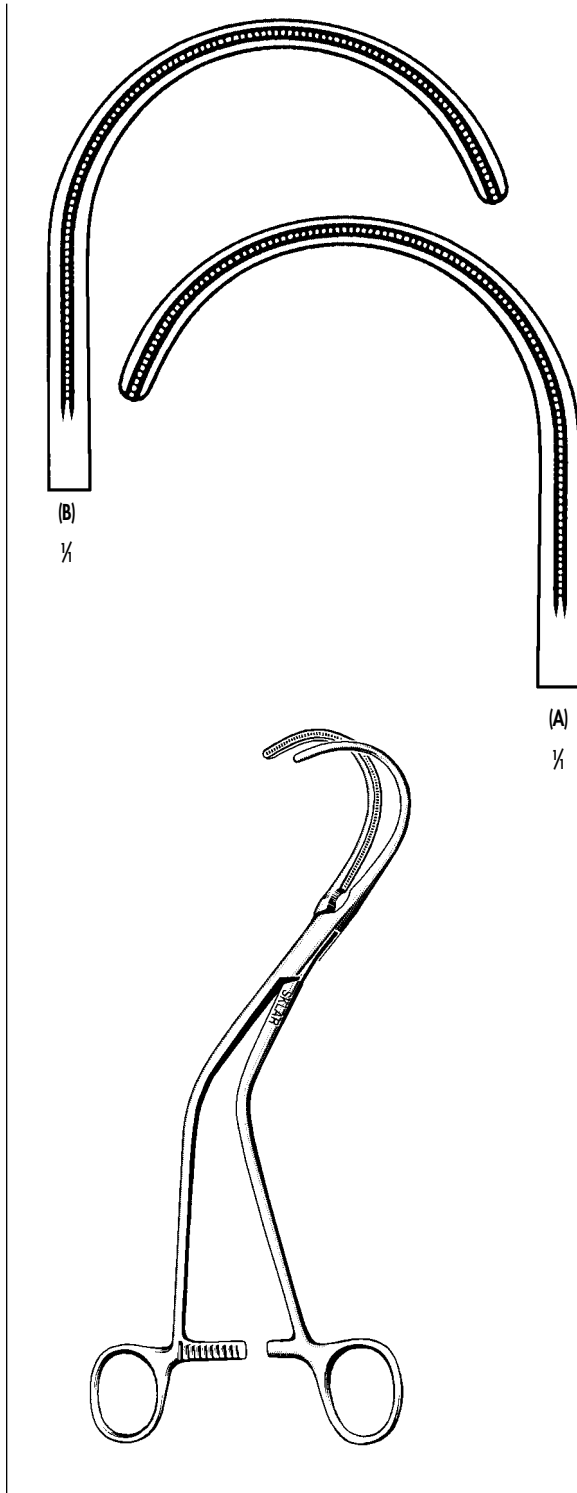
DEBAKEY HALSTED MOSQUITO FORCEPS

52-6830 5" Straight (A)
52-6832 5" Curved (B)



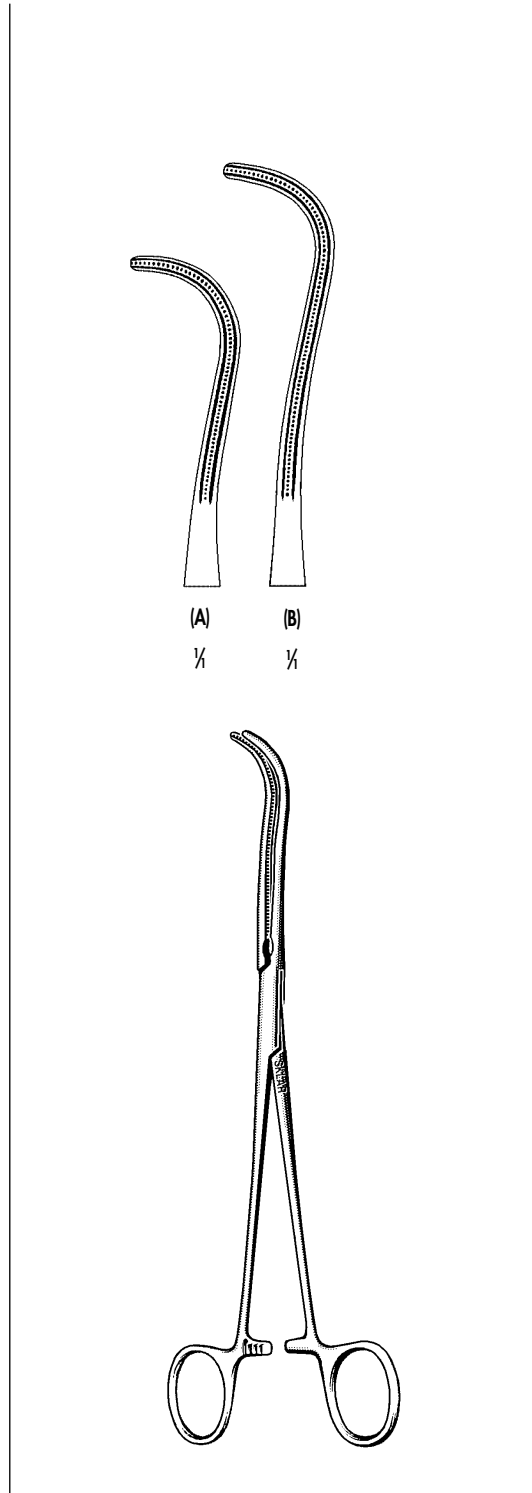
DEBAKEY PEAN FORCEPS

52-6840 6" Straight (A)
52-6842 6" Curved (B)



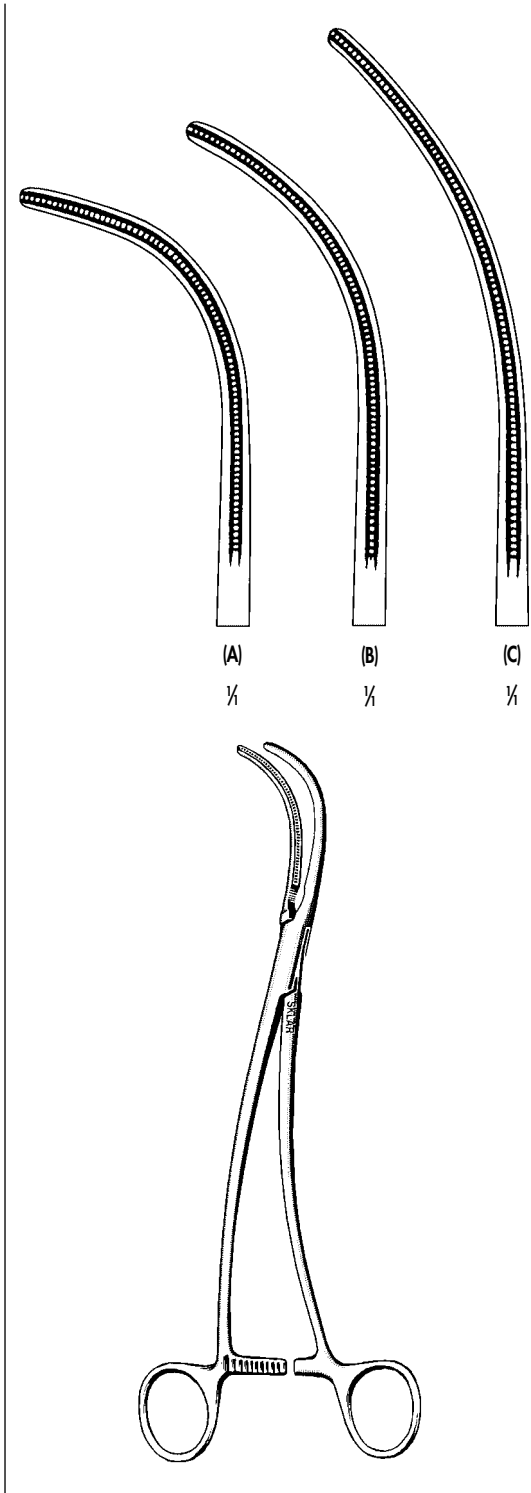
WEBER AORTIC CLAMP

52-6680 10" Right (A)
52-6681 10" Left (B)



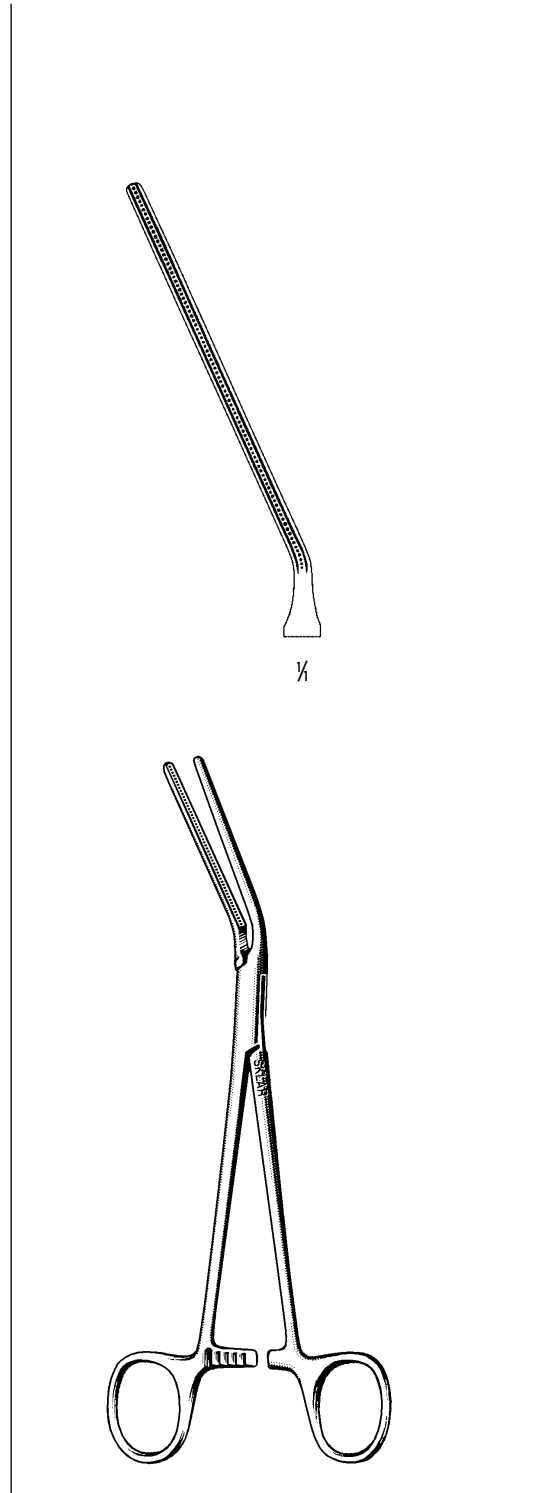
DEBAKEY DISSECTING AND LIGATURE FORCEPS

52-6820 8" (A)
52-6822 9½" (B)



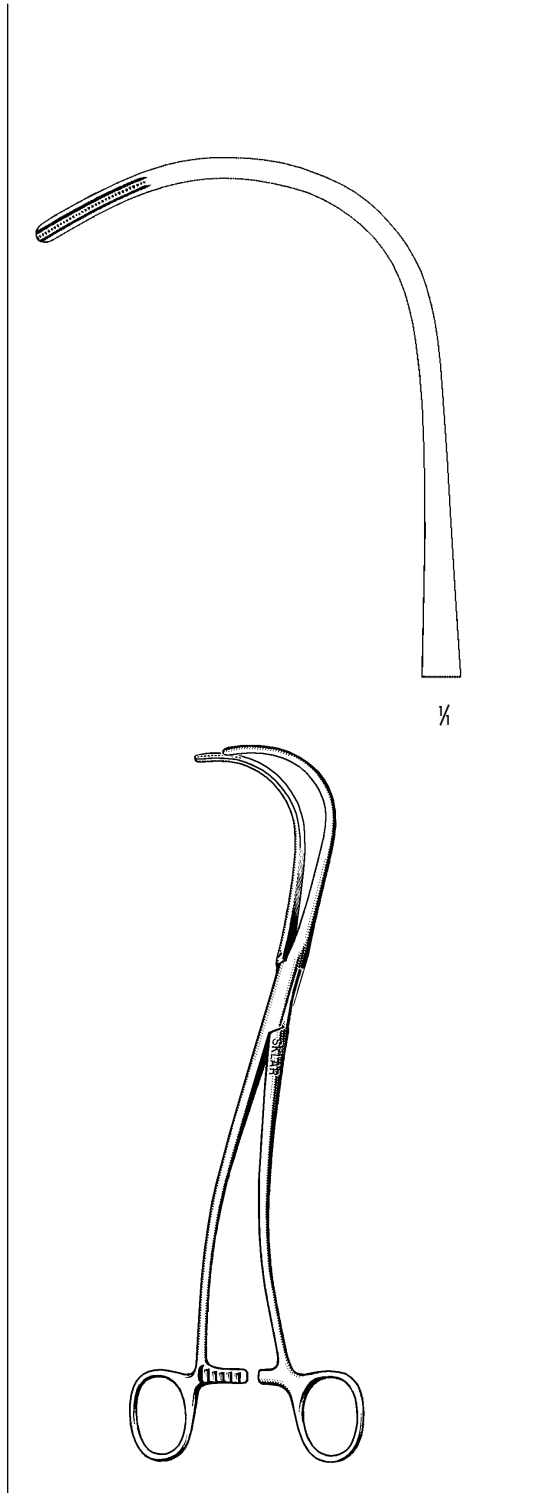
DEBAKEY-BAHNSON ATRAUMATIC FORCEPS

- 52-6795 9½" (A)
- 52-6796 10" (B)
- 52-6797 10½" (C)



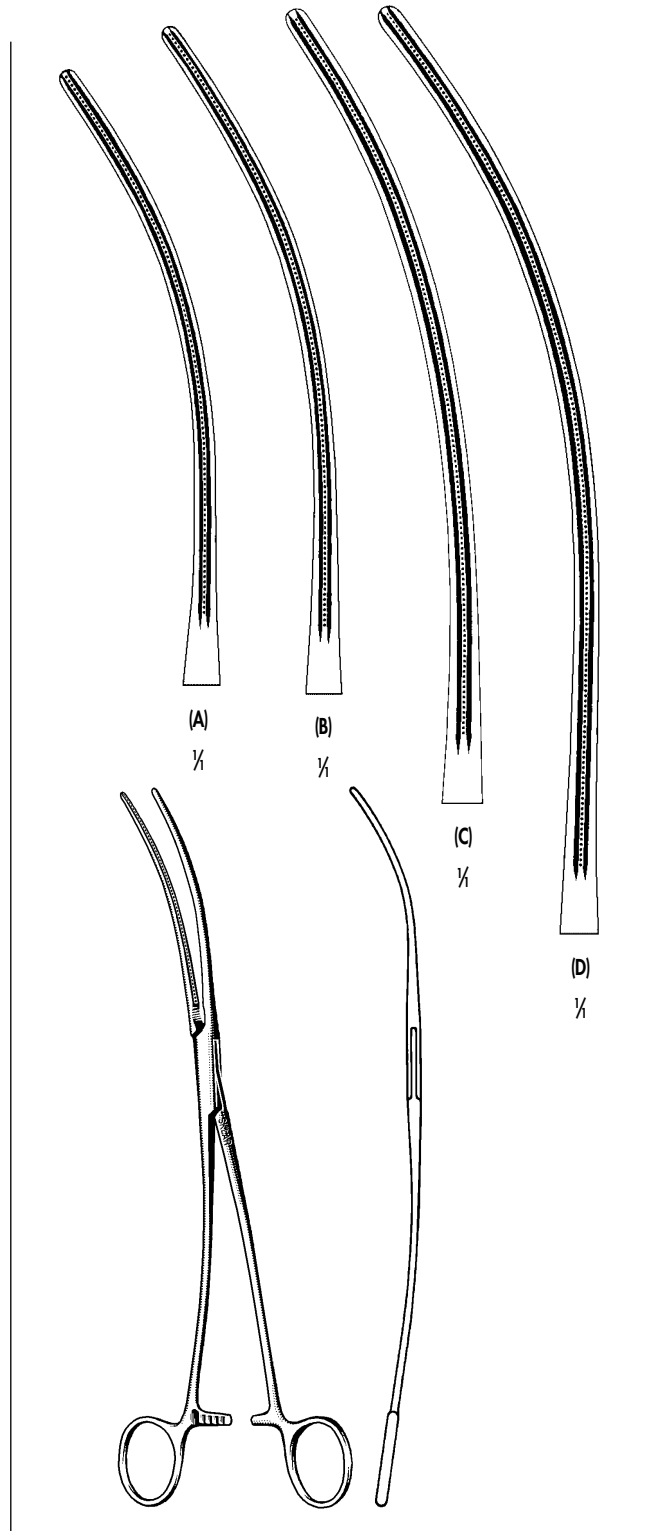
DEBAKEY ANGULAR CLAMP

52-6740 8½"



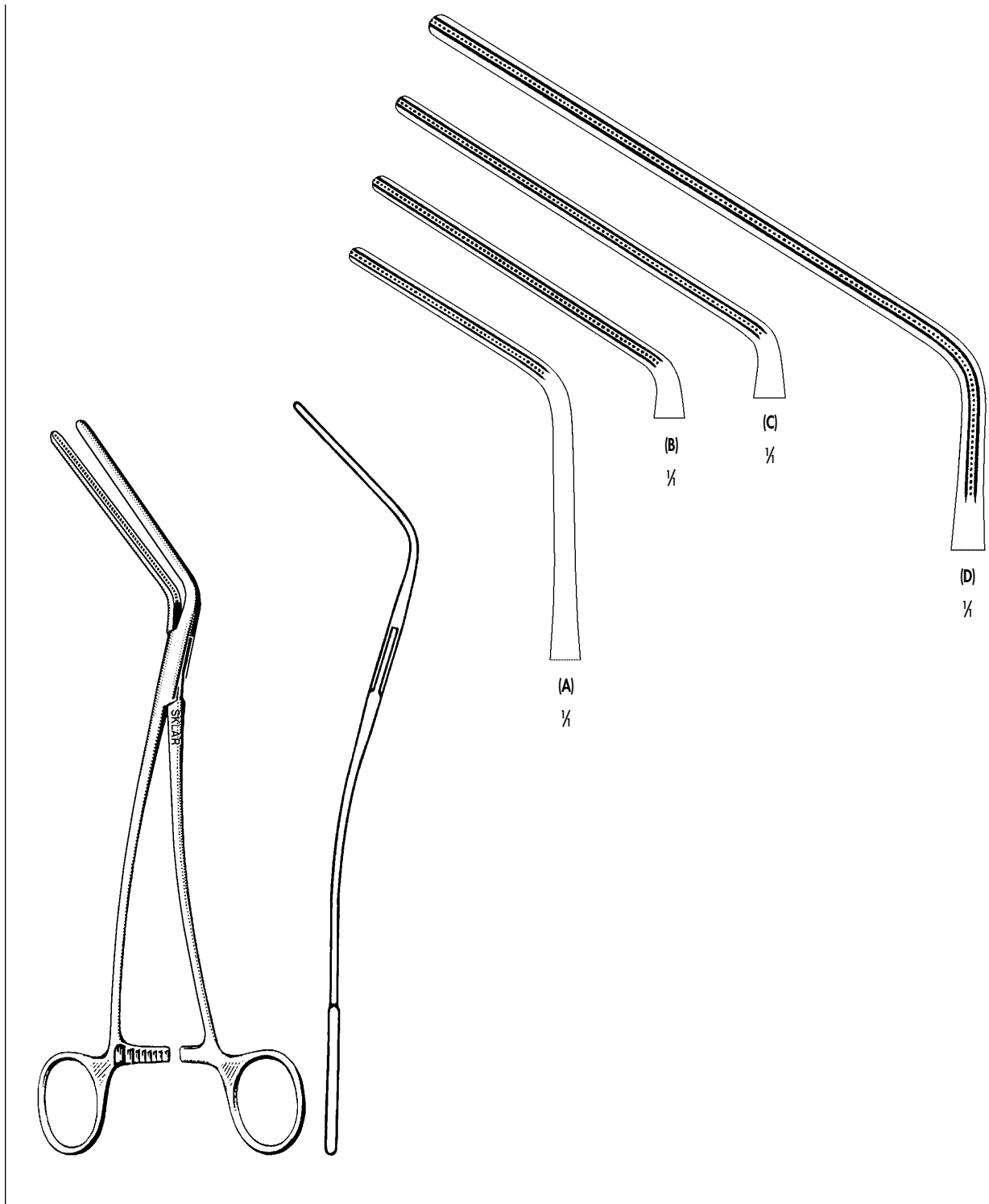
DEBAKEY-SEMB LIGATURE CARRIER

52-6850 10 1/4" Jaw Length 1.5 cm



DEBAKEY AORTIC ANEURYSM CLAMP

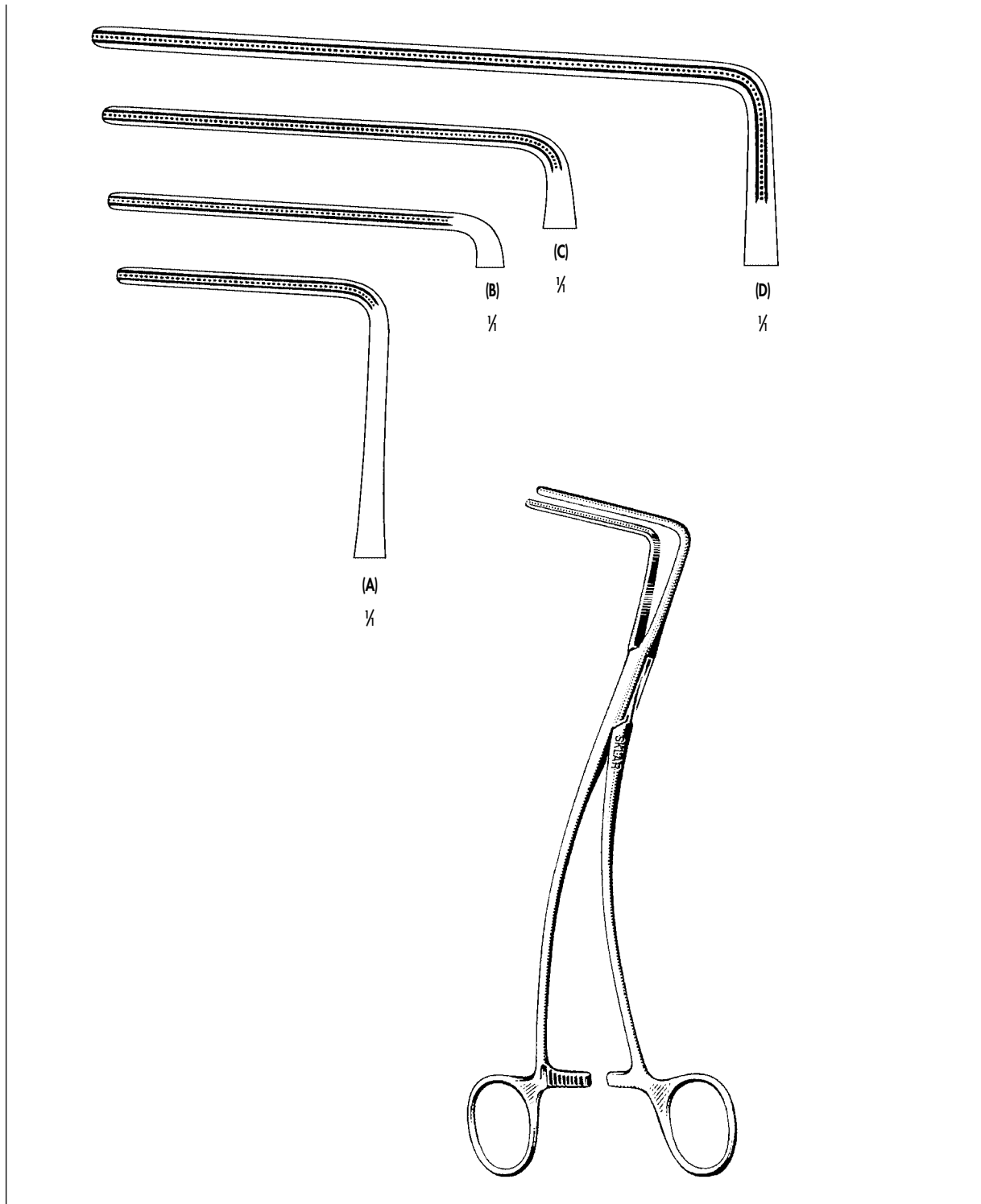
52-6648 9 1/2" (A)
 52-6661 10 1/2" (B)
 52-6662 12 1/2" (C)
 52-6663 13" (D)



DEBAKEY ATRAUMATIC FORCEPS

Multi-Purpose 60° Angle

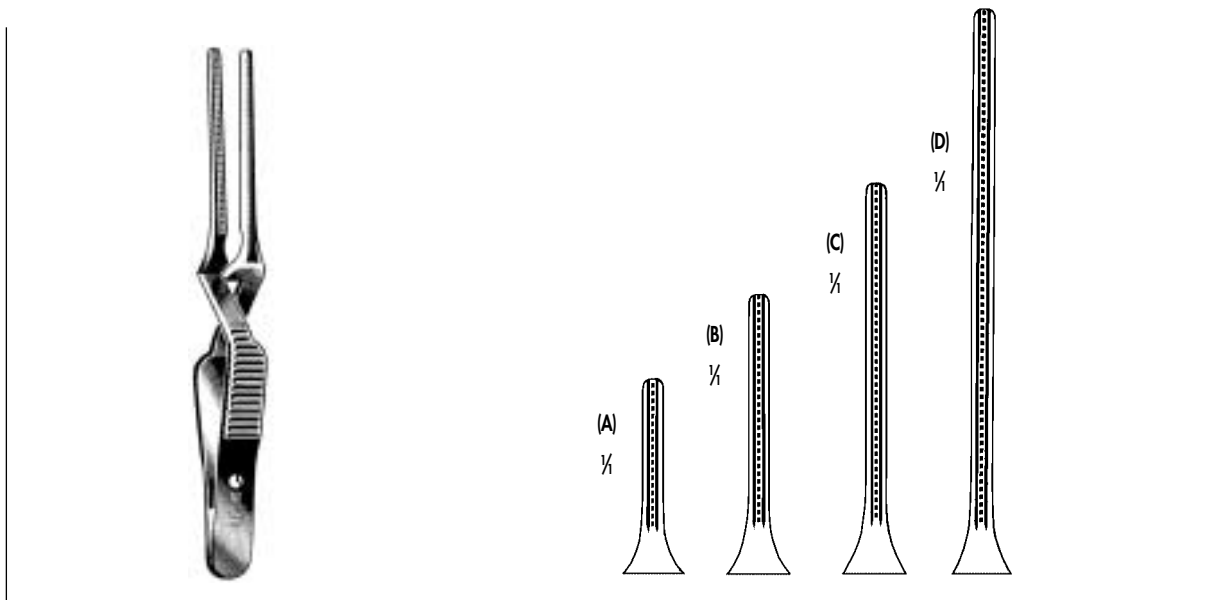
- 52-6631 10" (A)
- 52-6630 8" (B)
- 52-6634 9 1/2" (C)
- 52-6635 12" (D)



DEBAKEY ATRAUMATIC FORCEPS

Multi-Purpose 90° Angle

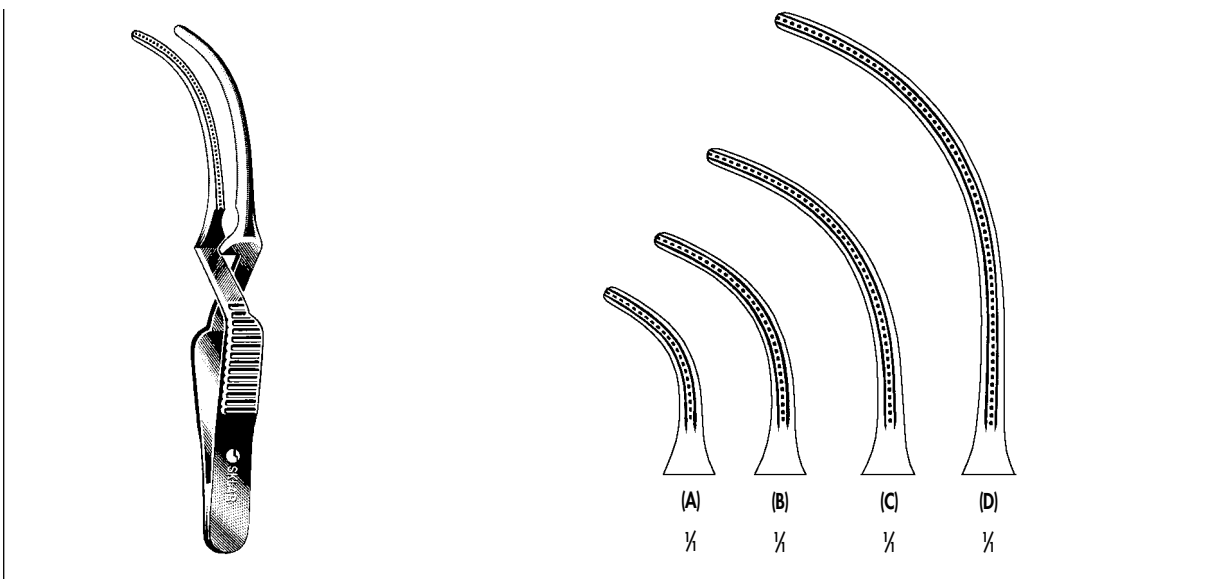
- | | | |
|---------|--------|-----|
| 52-6640 | 9" | (A) |
| 52-6641 | 7" | (B) |
| 52-6644 | 8 1/2" | (C) |
| 52-6645 | 11" | (D) |



DEBAKEY BULLDOG CLAMP

Straight Cross Action

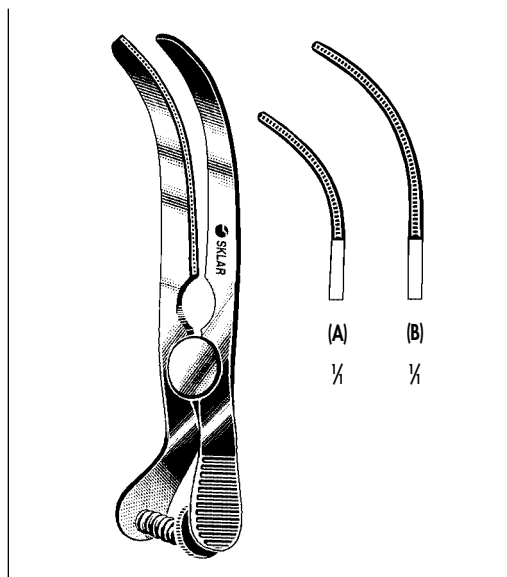
52-1530	3"	(7.6 cm)	(A)
52-1531	3½"	(8.9 cm)	(B)
52-1532	4¼"	(10.8 cm)	(C)
52-1533	4¾"	(12.1 cm)	(D)



DEBAKEY BULLDOG CLAMP

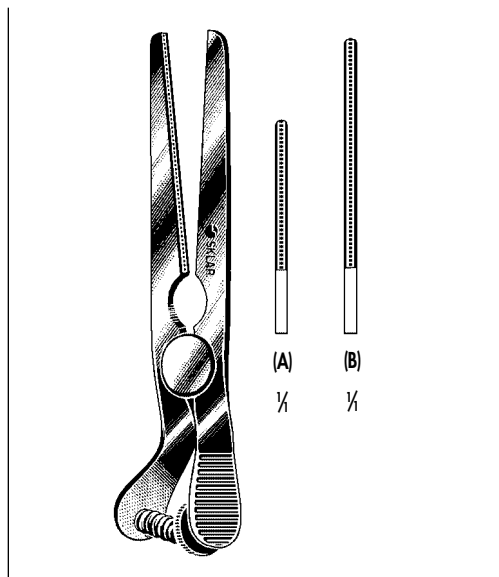
Curved Cross Action

52-1540	2¾"	(7 cm)	(A)
52-1541	3¾"	(7.8 cm)	(B)
52-1542	4"	(10.2 cm)	(C)
52-1543	4¾"	(12.1 cm)	(D)



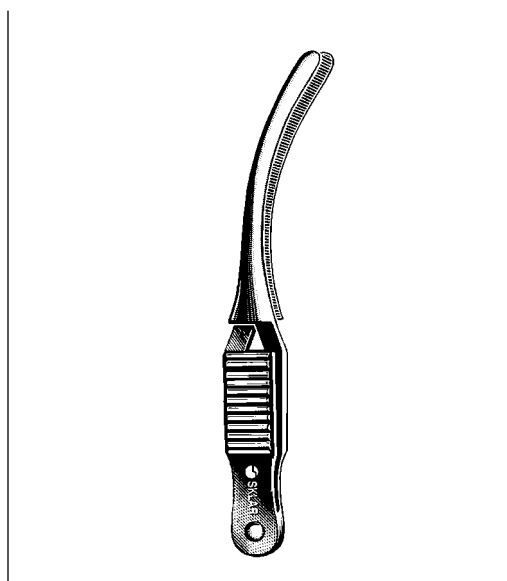
GLOVER BULLDOG CLAMP CURVED

52-1550 Overall Length 5.5 cm Jaw Length 2 cm (A)
 52-1551 Overall Length 6.5 cm Jaw Length 3 cm (B)



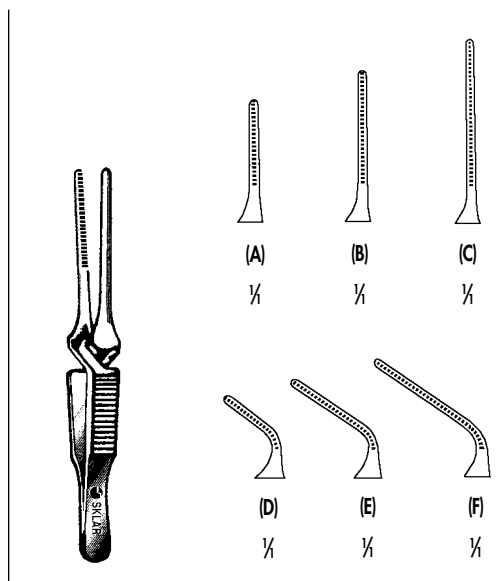
GLOVER BULLDOG CLAMP

Straight
 52-1545 2 1/2" Straight (A)
 52-1546 2 3/4" Straight (B)



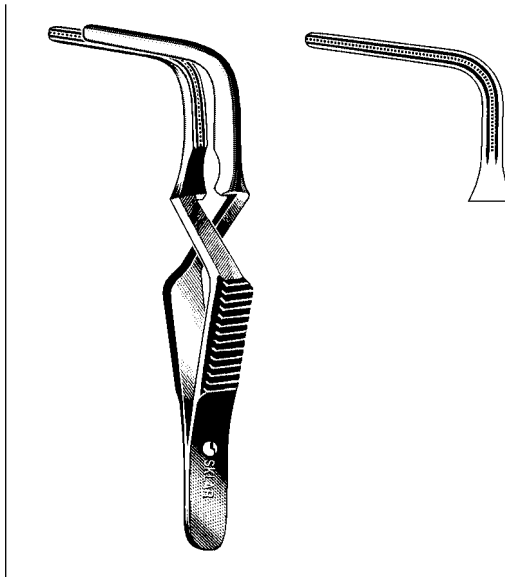
JOHNS HOPKINS BULLDOG CLAMP

52-1415 1 1/2" (3.8 cm)
 52-1417 1 3/4" (4.4 cm)
 52-1420 2" (5.1 cm)
 52-1422 2 1/4" (5.7 cm)
 52-1425 2 1/2" (6.4 cm)
 52-1427 2 3/4" (7 cm)
 52-1430 3" (7.6 cm)
 52-1435 3 1/2" (8.9 cm)



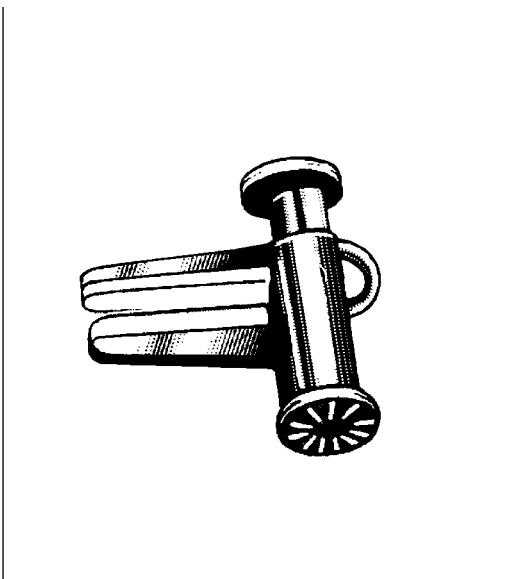
DIETRICH MICROCORONARY BULLDOG CLAMP

98-4008 8 mm Straight (A)
 98-4012 12 mm Straight (B)
 98-4020 20 mm Straight (C)
 98-4108 8 mm Angled (D)
 98-4112 12 mm Angled (E)
 98-4120 20 mm Angled (F)



SANTULLI BULLDOG CLAMP

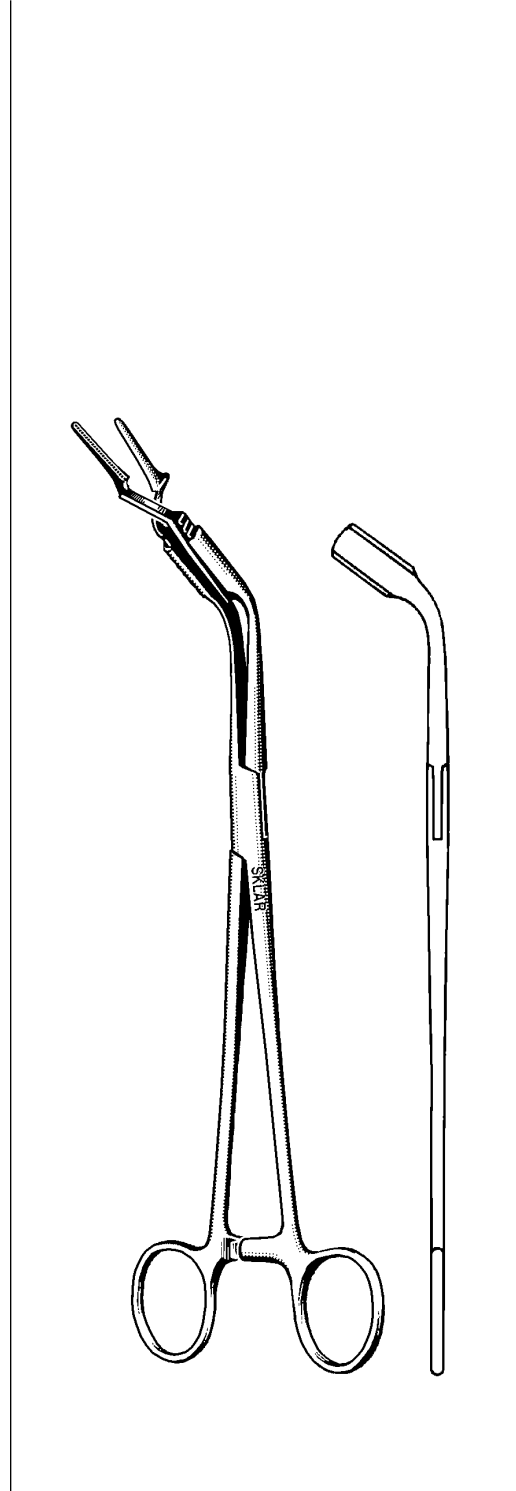
52-1548 2 3/8"



EDWARDS BULLDOG CLAMP

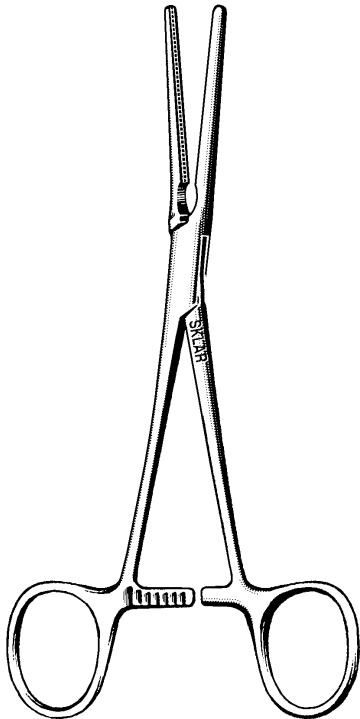
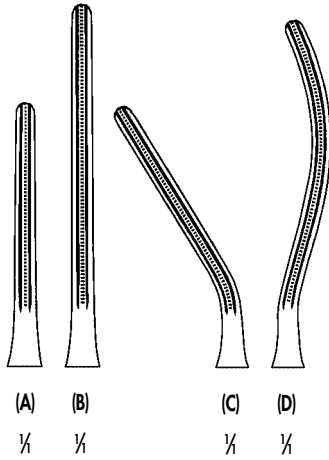
Replaceable Soft Jaw Lining

52-1485 6mm Jaw
52-1488 12mm Jaw



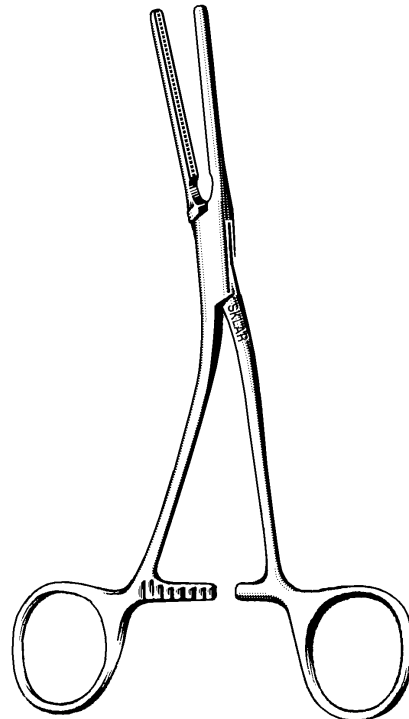
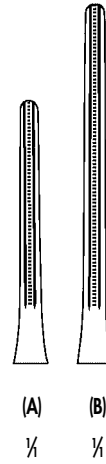
BULLDOG CLAMP APPLYING FORCEPS

52-1390 9" Applying Clamp Only



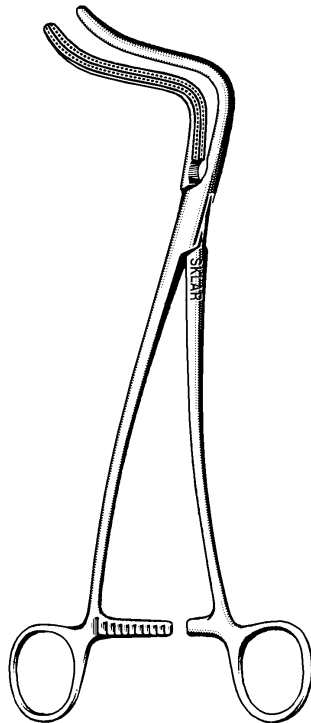
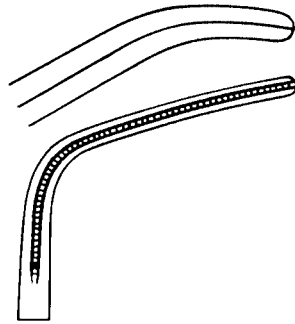
DEBAKEY PEDIATRIC FORCEPS

52-1900	6 1/4"	(A)	Patent Ductus
52-1902	6 1/2"	(B)	Coarctation
52-1904	6"	(C)	Angular
52-1906	6 1/2"	(D)	Spoon Shape



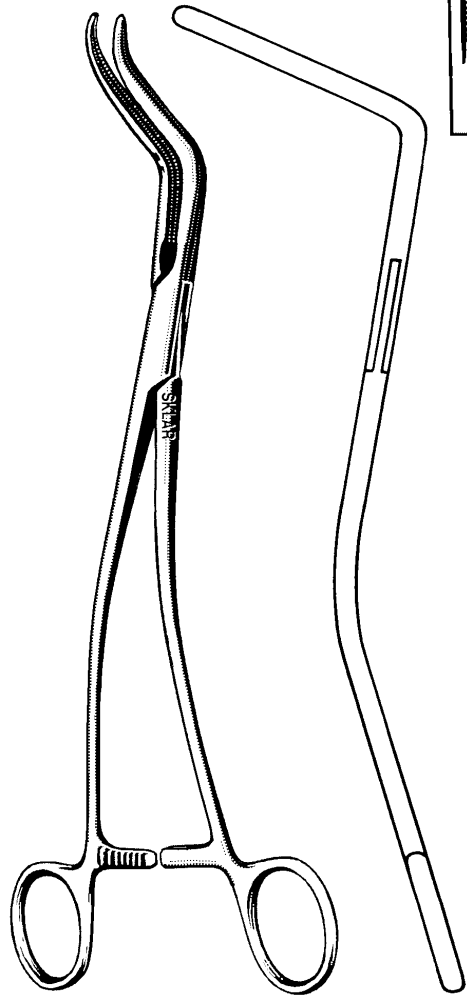
DEBAKEY PEDIATRIC FORCEPS

Angular Shaft			
52-1910	6"	(A)	Patent Ductus
52-1912	6 1/2"	(B)	Coarctation



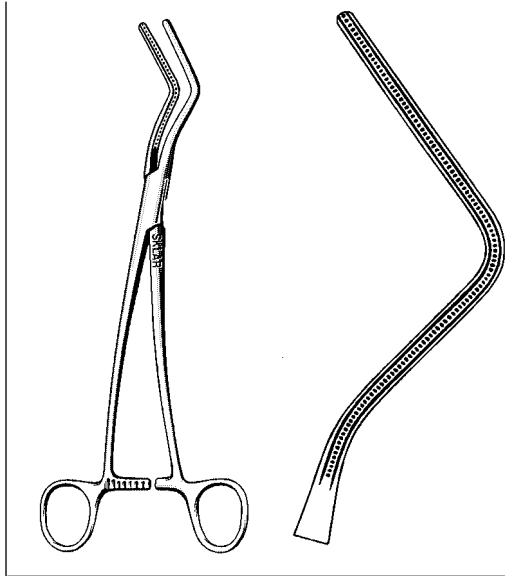
SUBRAMANIAN MINIATURE AORTA CLAMP

52-1920 5/8"



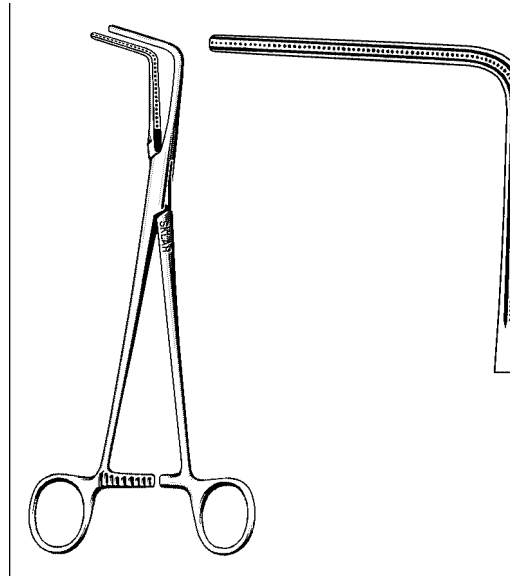
DEBAKEY BRONCHUS FORCEPS

52-2385 10/8"



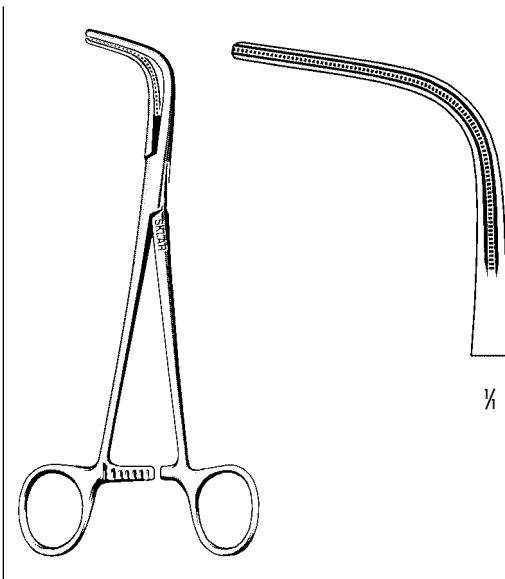
LEES BRONCHUS CLAMPS

52-2382 9 $\frac{1}{4}$ "



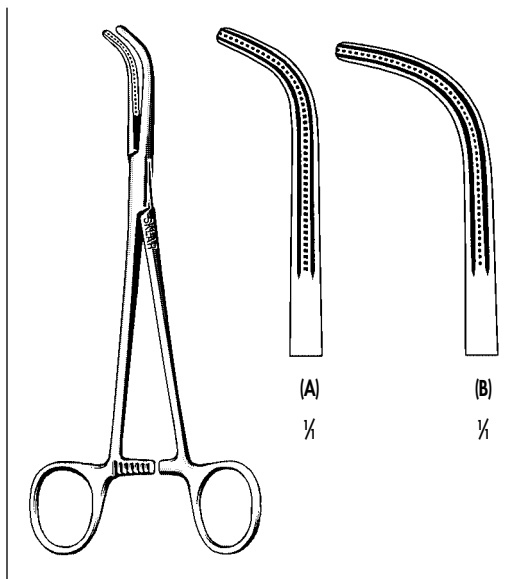
LEES BRONCHUS CLAMP

52-2380 9"



**DEBAKEY-MCQUIGG-MIXTER
THORACIC CLAMP**

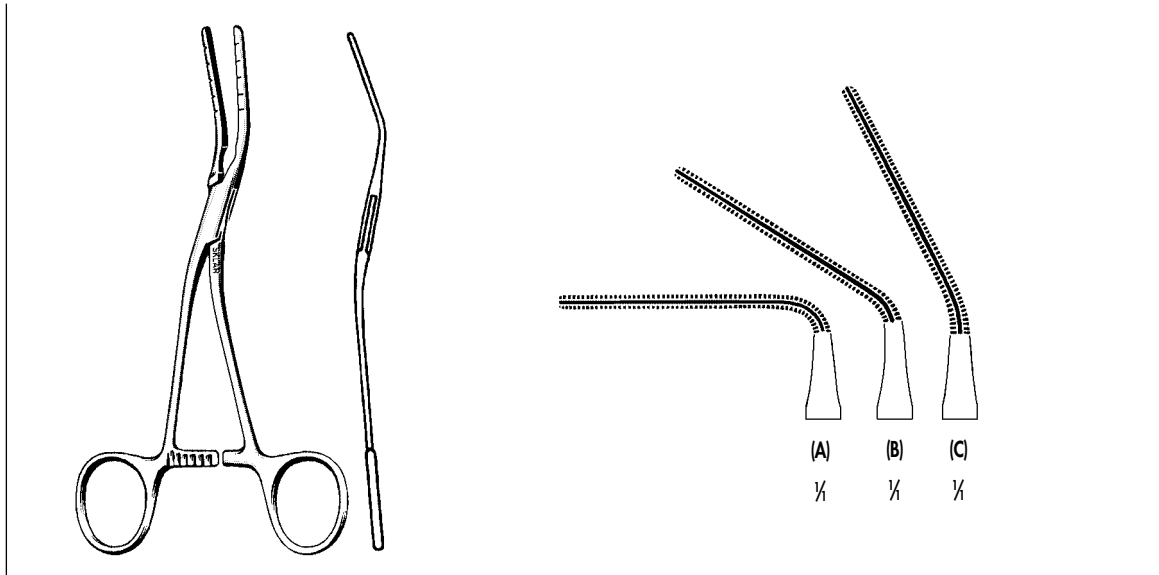
52-6825 8"



DEBAKEY-COLOVIRAS-RUMEL CLAMP

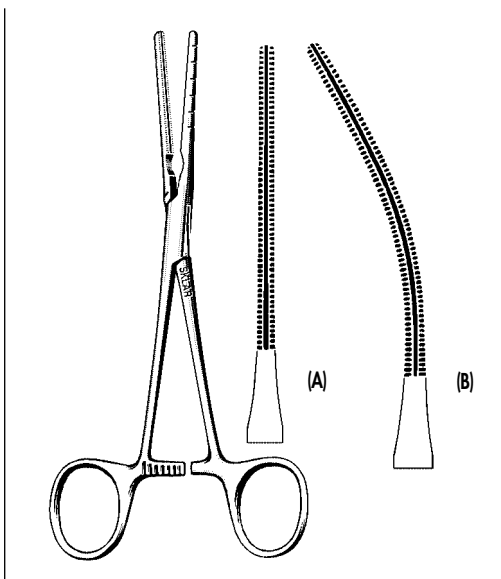
52-6860 7 $\frac{1}{2}$ " (A)

52-6862 7 $\frac{1}{2}$ " (B)



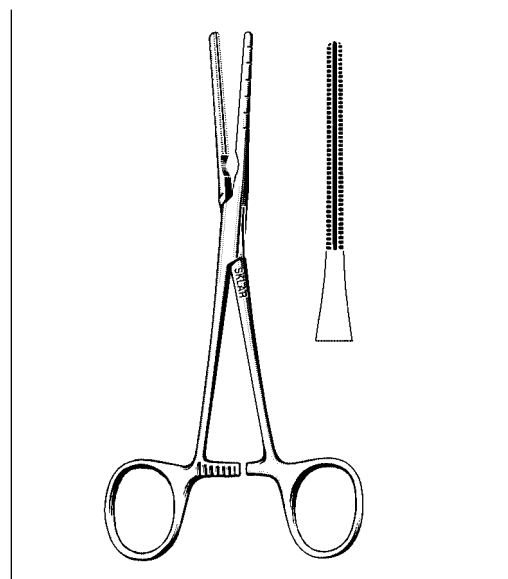
COOLEY MULTI-PURPOSE CLAMPS

- 52-6900 5½" 90° Angle (A)
- 52-6902 6½" 45° Angle (B)
- 52-6904 6½" 30° Angle (C)



COOLEY MULTI-PURPOSE CLAMPS

- 52-6910 6½" Straight (A)
- 52-6912 6¾" Curved (B)



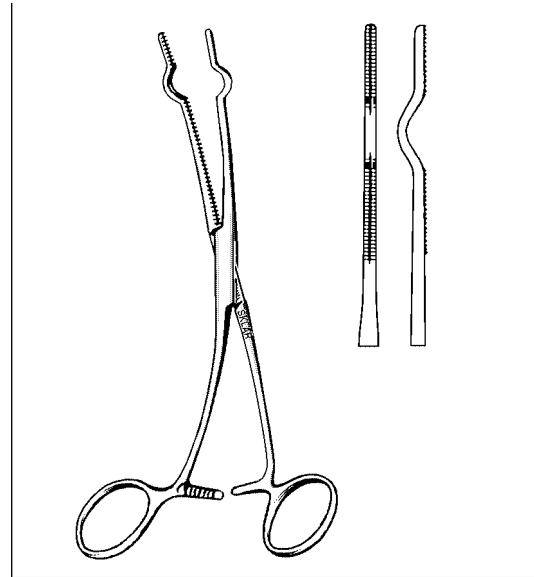
COOLEY MULTI-PURPOSE CLAMPS

- 52-6920 6" Straight



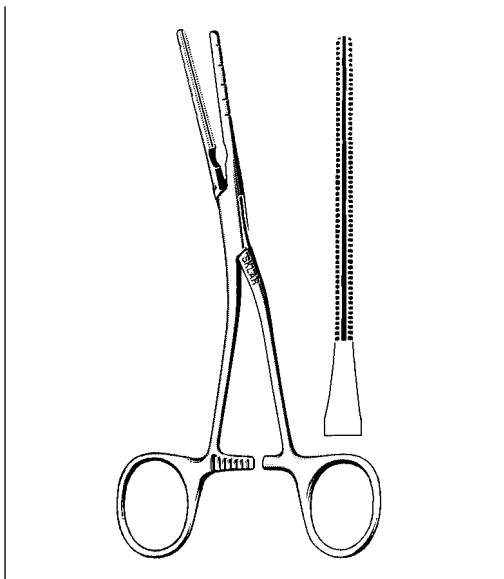
COOLEY PATENT DUCTUS FORCEPS

52-6925 6"



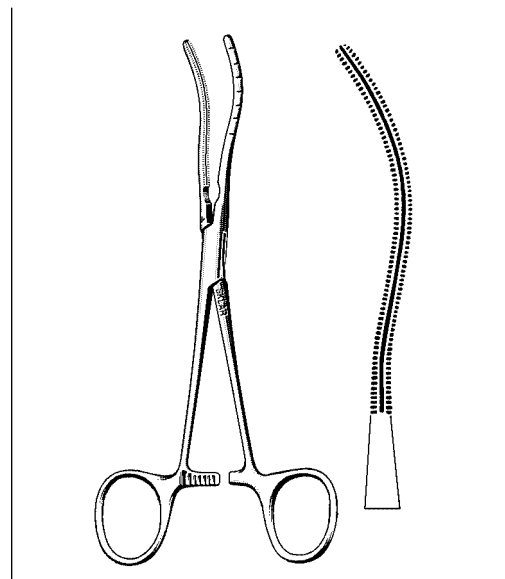
COOLEY CAVA OCCLUSION CLAMP

- 52-7040 24 French Diameter
- 52-7042 26 French Diameter
- 52-7044 28 French Diameter
- 52-7046 30 French Diameter
- 52-7048 32 French Diameter
- 52-7050 36 French Diameter



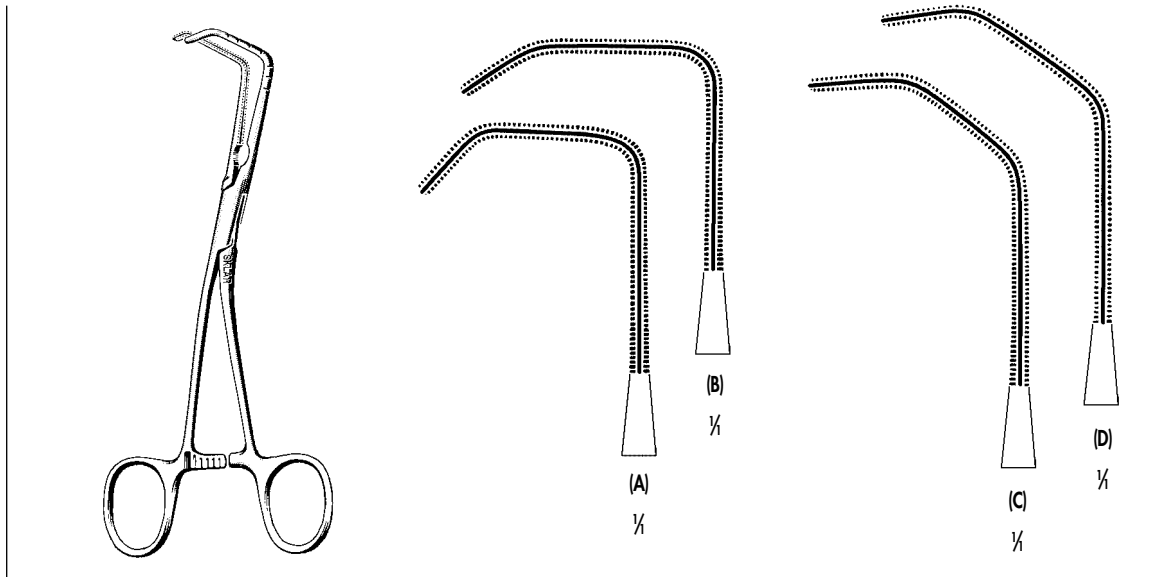
COOLEY COARCTATION FORCEPS

52-6930 6½"



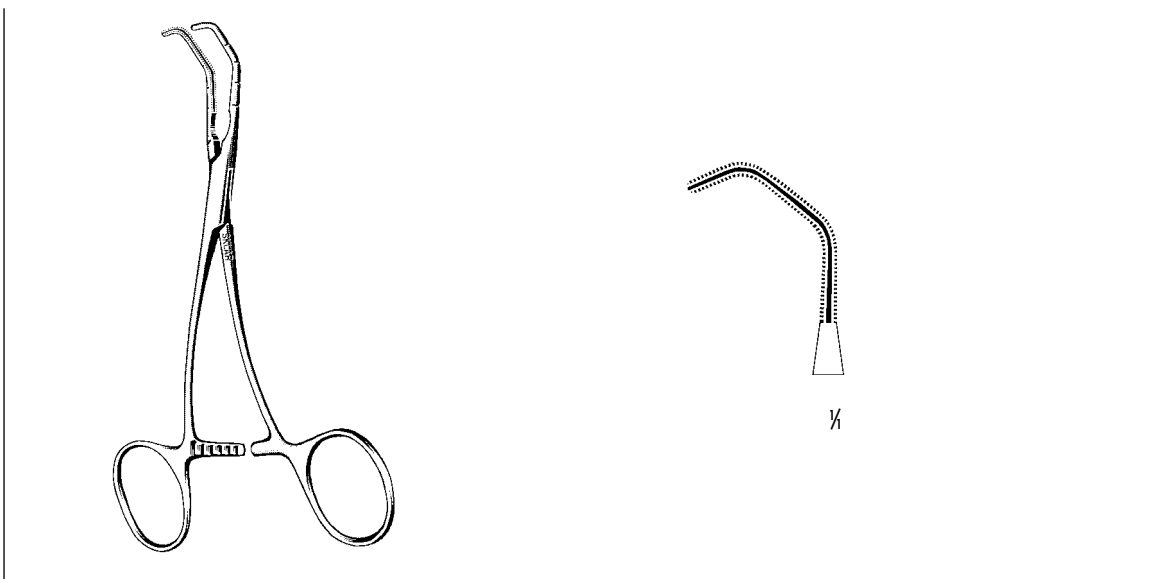
COOLEY VASCULAR FORCEPS

52-6935 6" Spoon Shaped



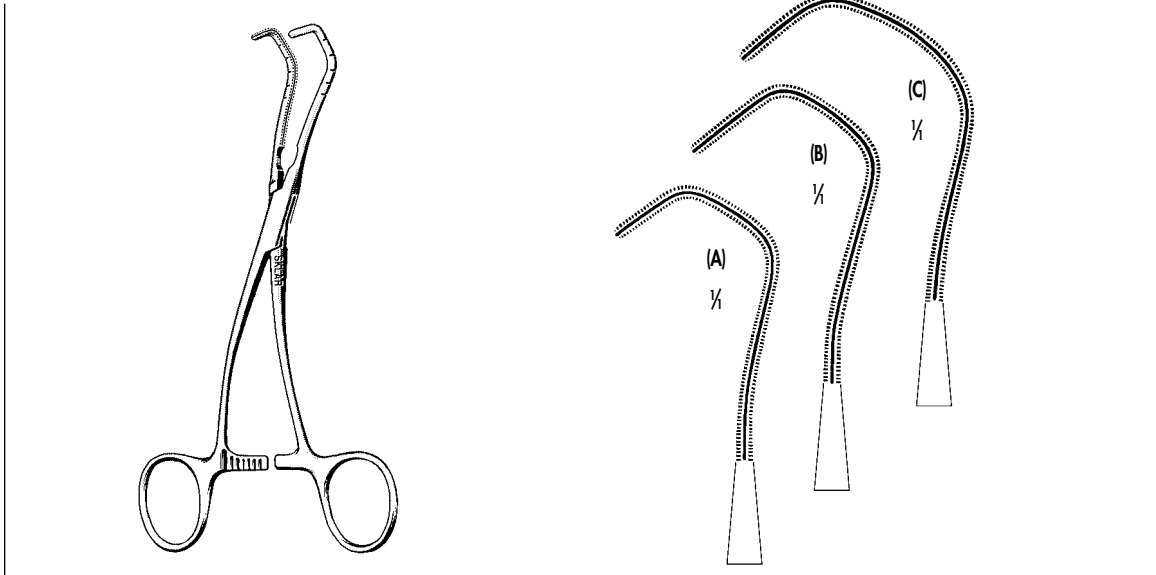
COOLEY ANASTOMOSIS FORCEPS

- 52-6945 6½" 90° (A)
- 52-6946 6½" 90° (B)
- 52-6947 6½" 60° (C)
- 52-6948 6½" 60° (D)



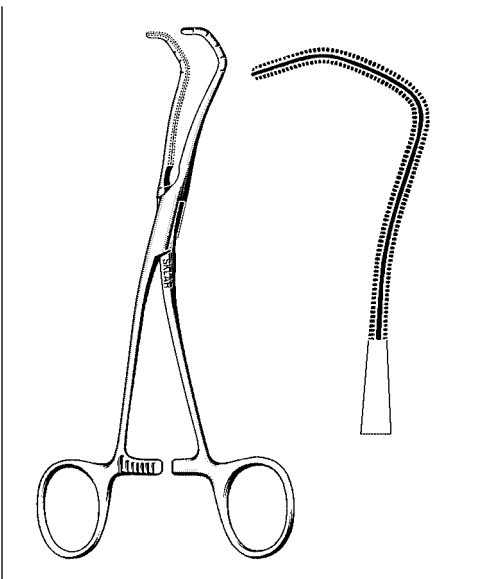
COOLEY SATINSKY ANASTOMOSIS FORCEPS

- 52-6950 5½"



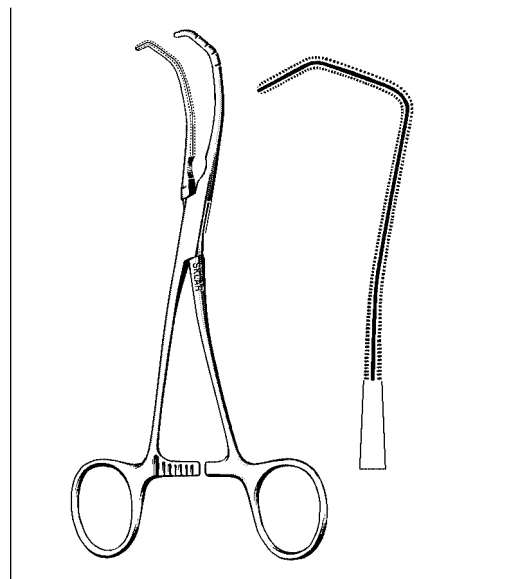
COOLEY-DERRA ANASTOMOSIS CLAMP

- 52-6955 6½" Small (A)
- 52-6956 6½" Medium (B)
- 52-6957 6½" Large (C)



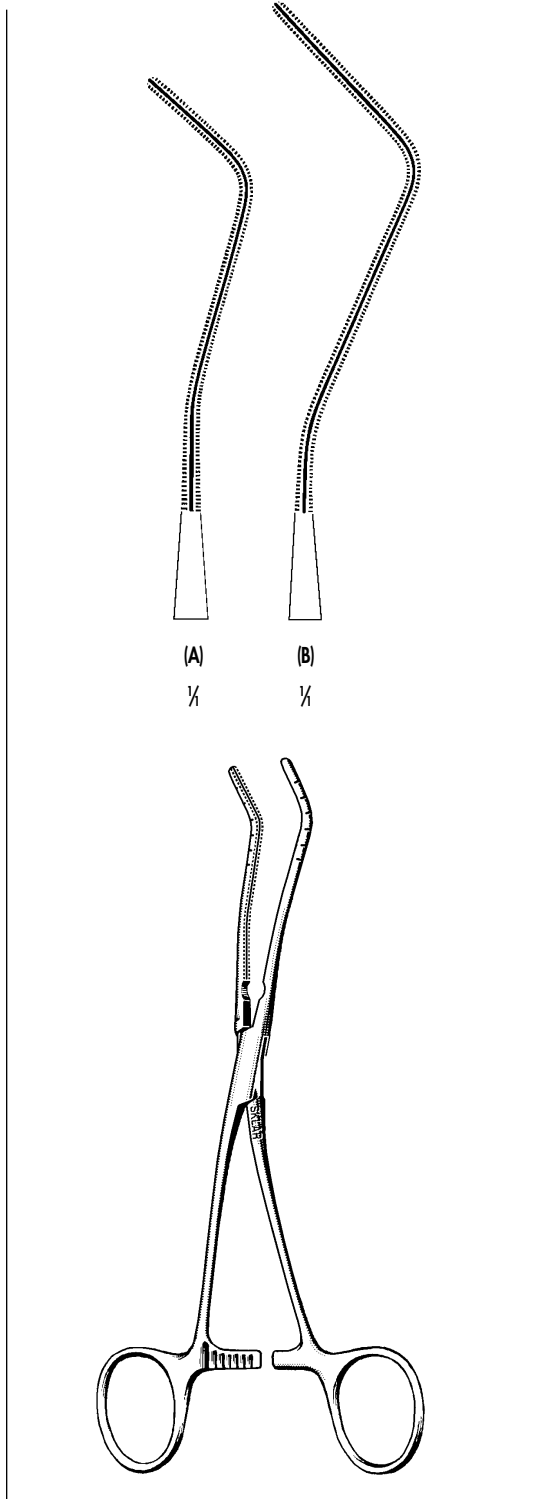
COOLEY ANASTOMOSIS CLAMP

- 52-6960 6½" Standard



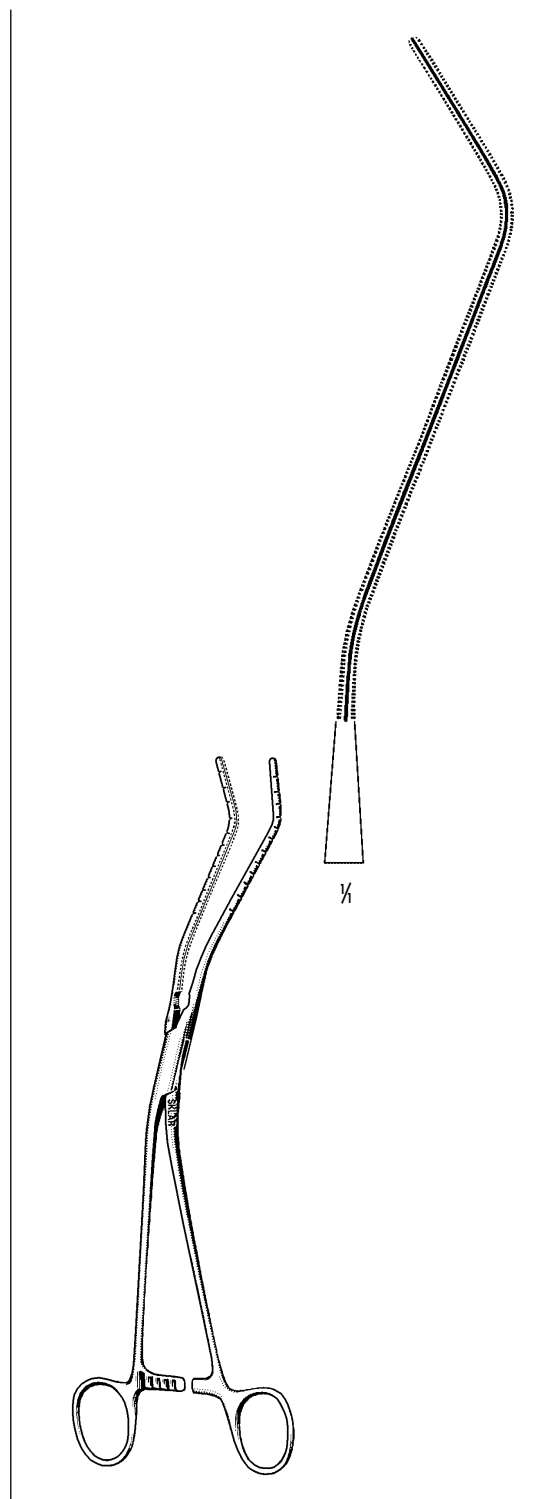
COOLEY ANASTOMOSIS CLAMP

- 52-6962 6½" Modified



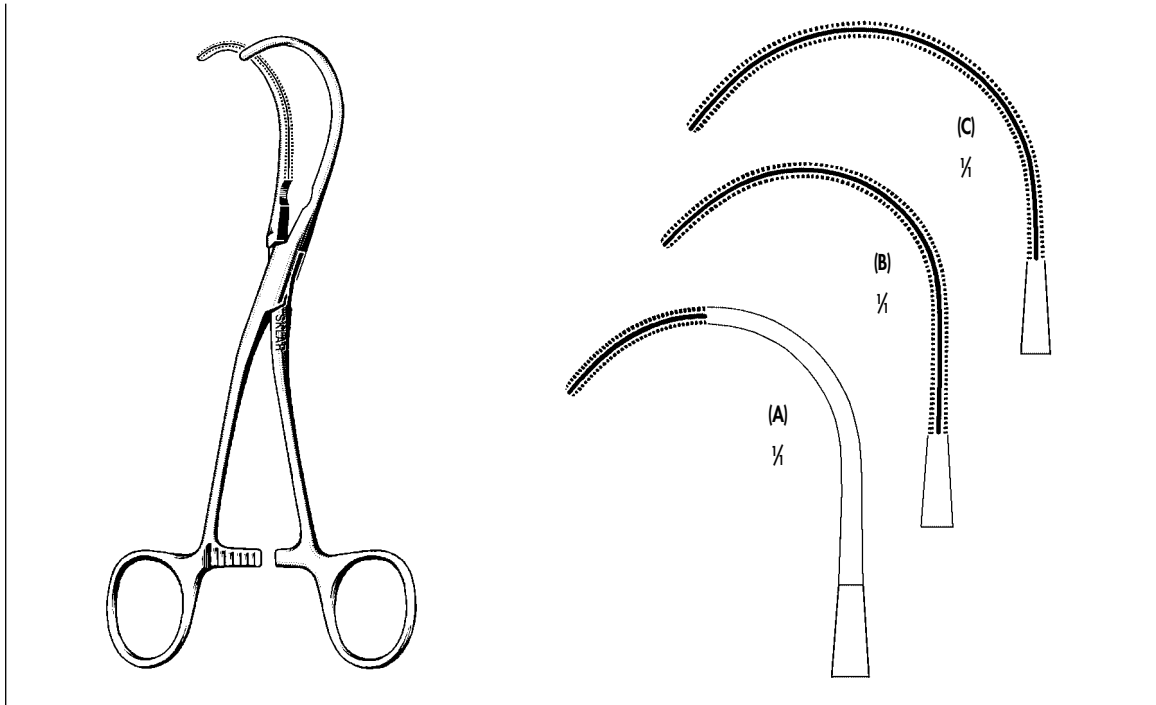
RENAL ARTERY CLAMP

Cooley Jaws
52-6965 7 1/2" (A)
52-6966 7 1/2" (B)



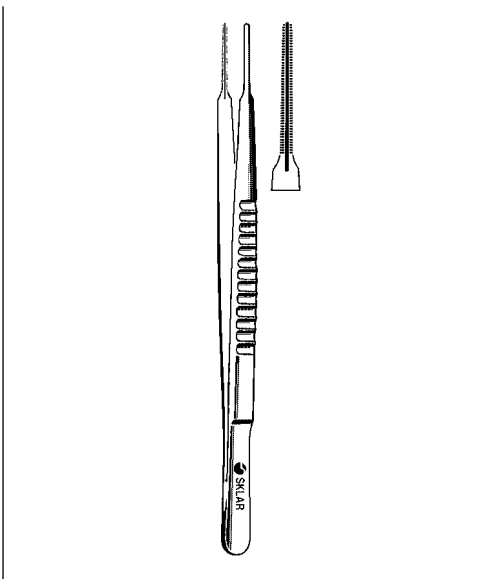
RENAL ARTERY CLAMP

Cooley Jaws
52-6968 10 3/4"



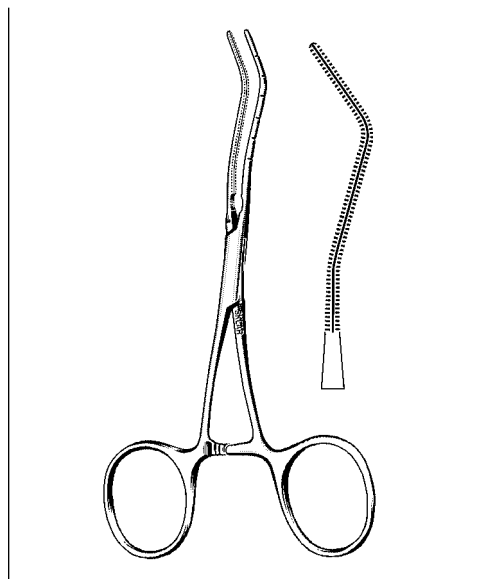
COOLEY LIGATURE CARRIERS

- 52-6975 6½" (A) Partial Serrations
- 52-6976 6½" (B) Short Curve
- 52-6977 6½" (C) Long Curve



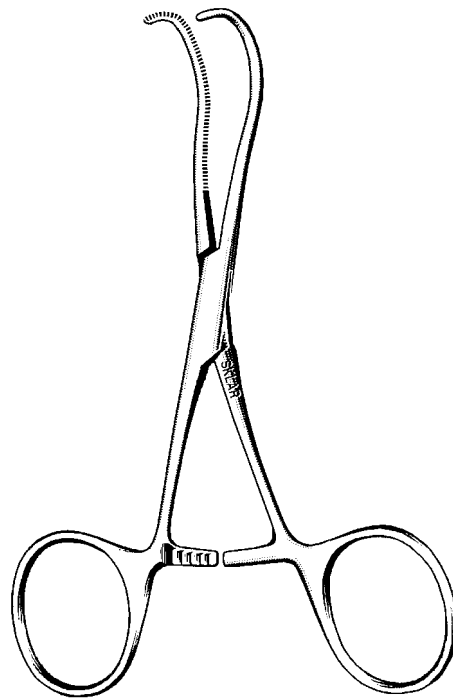
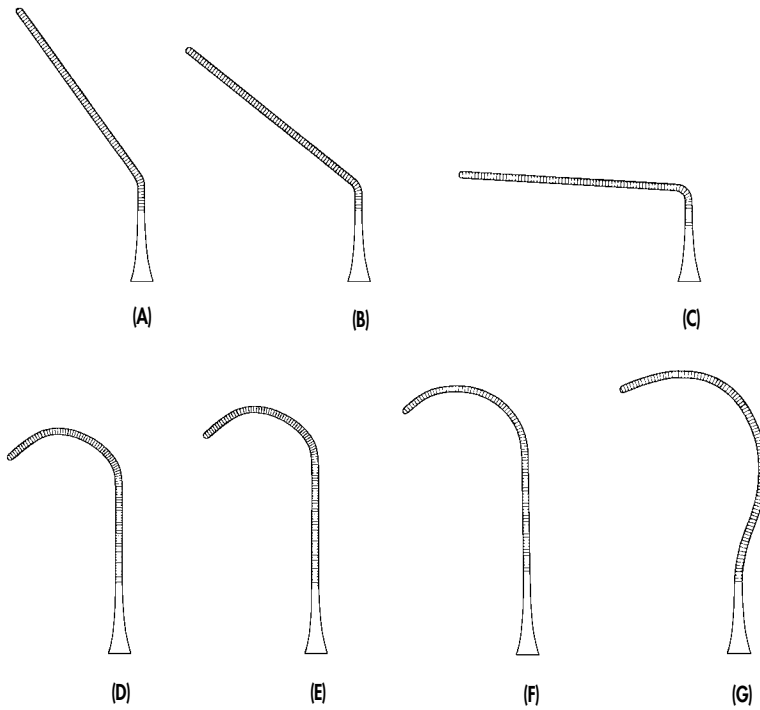
COOLEY VASCULAR TISSUE FORCEPS

- 52-6980 6"
- 52-6981 8"
- 52-6982 9½"



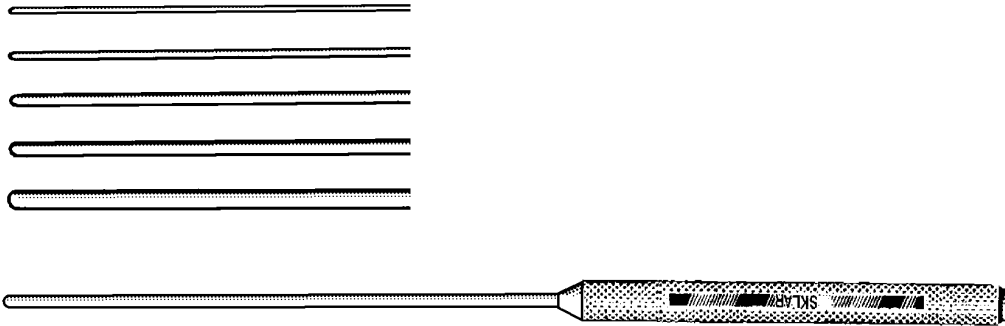
COOLEY NEONATAL VASCULAR CLAMP

- 52-6985 5"



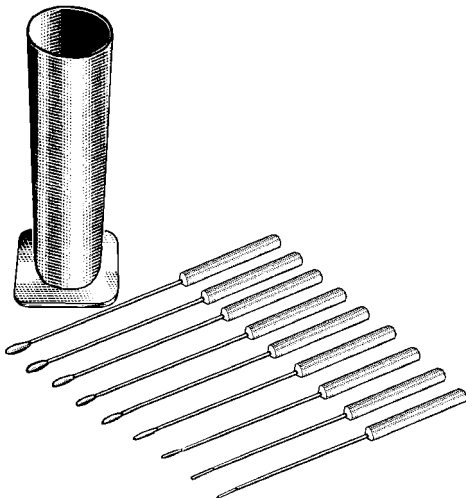
CASTANEDA NEONATAL CLAMP

52-6990	5"	(A)
52-6991	5"	(B)
52-6992	5"	(C)
52-6993	6"	(D)
52-6994	6"	(E)
52-6995	6"	(F)
52-6996	6"	(G)



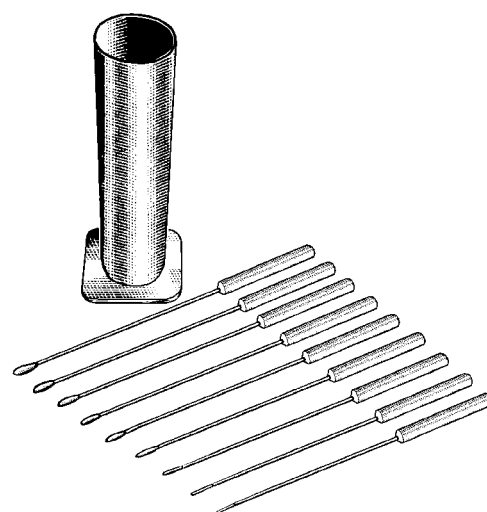
COOLEY DILATORS

52-7030 5½" Aluminum Handle
Set of 6, malleable aluminum shafts



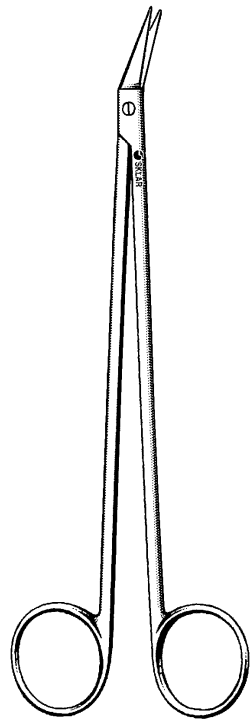
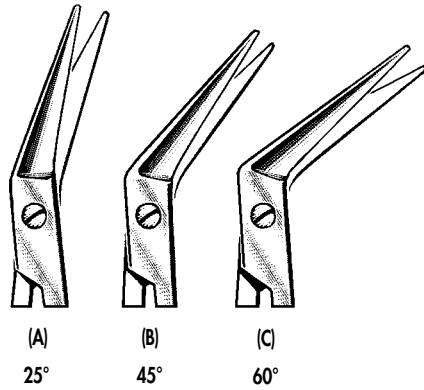
VASCULAR DILATORS SHORT

52-7000 Set of 9 short dilators (1, 1.5, 2, 2.5, 3, 3.5, 4, 4.5 and 5 mm). 14 cm (5½") long in stainless steel storage cylinder.



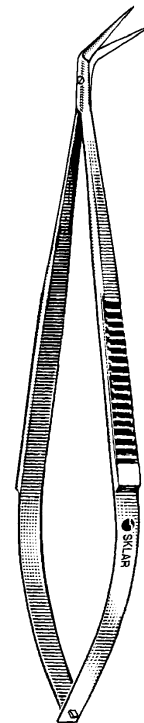
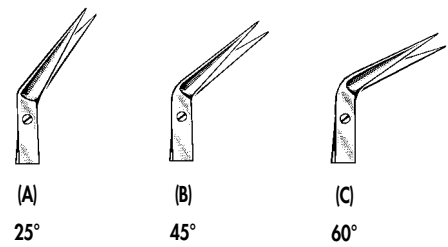
VASCULAR DILATORS LONG

52-7020 Set of 9 long dilators (1, 1.5, 2, 2.5, 3, 3.5, 4, 4.5 and 5 mm). 22 cm (8¾") long in stainless steel storage cylinder.



POTTS-SMITH SCISSORS

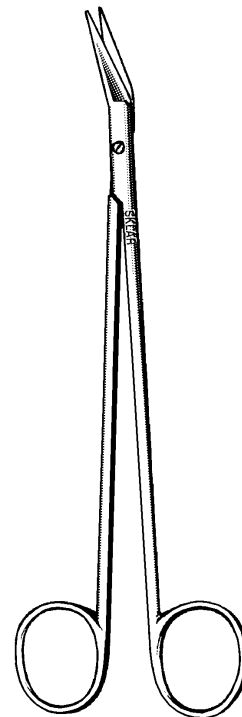
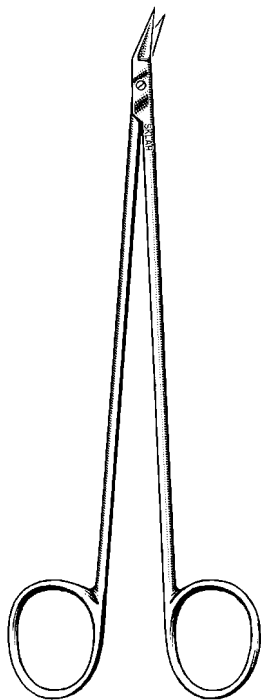
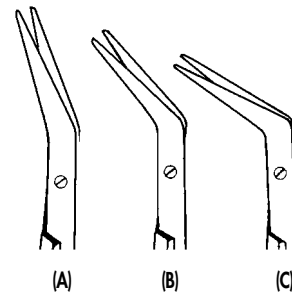
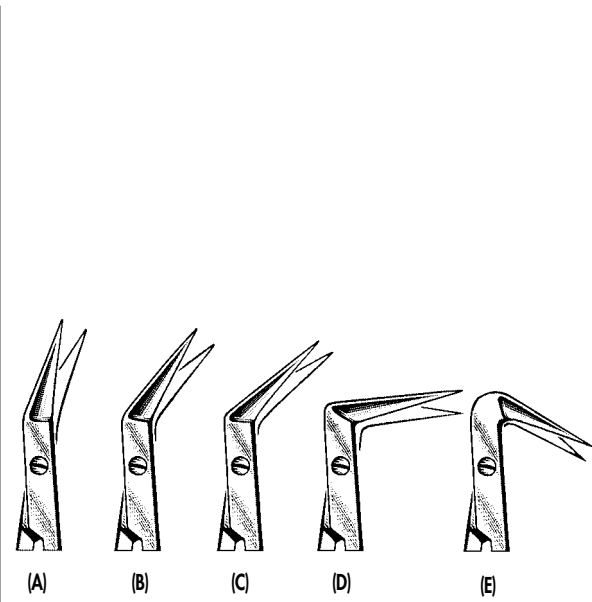
- 52-2825 7" 25° Angle (A)
- 52-2845 7" 45° Angle (B)
- 52-2860 7" 60° Angle (C)



SPRING HANDLE VASCULAR SCISSORS

Potts-Smith Type

- 98-1075 7" 25° Angle (A)
- 98-1076 7" 45° Angle (B)
- 98-1077 7" 60° Angle (C)

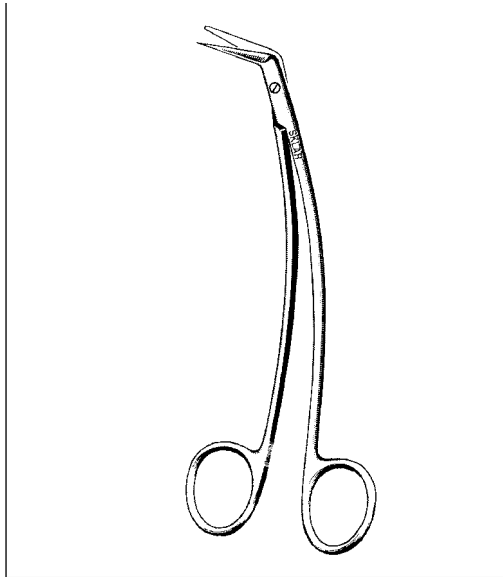


DIETRICH CORONARY ARTERY SCISSORS

- 52-3225 7" 25° Angle (A)
- 52-3245 7" 45° Angle (B)
- 52-3260 7" 60° Angle (C)
- 52-3290 7" 90° Angle (D)
- 52-3295 7" 125° Angle (E)

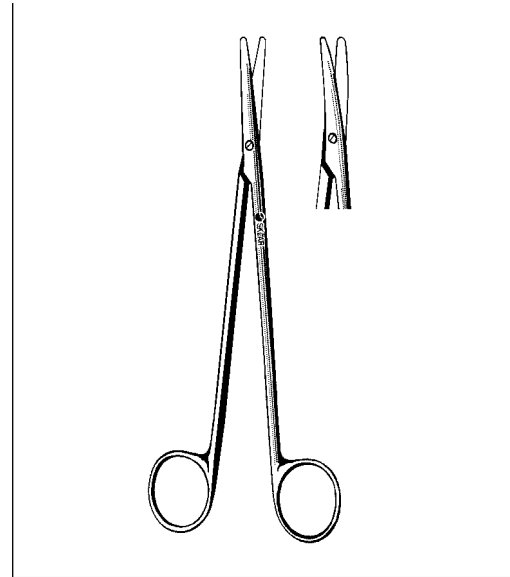
DEBAKEY VASCULAR SCISSORS

- 52-2800 7" 25° Angle (A)
- 52-2802 7" 45° Angle (B)
- 52-2804 7" 60° Angle (C)



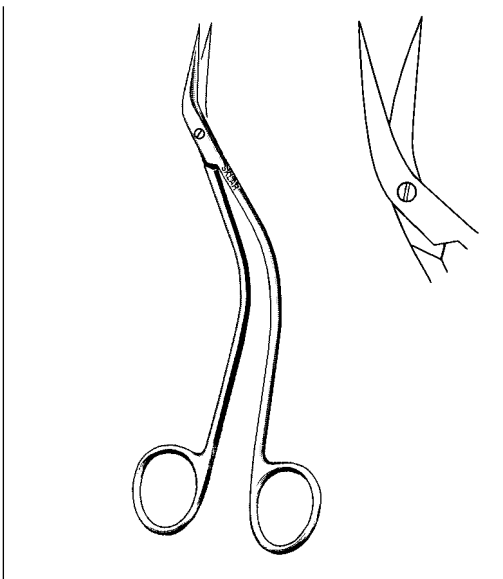
FAVALORO VASCULAR SCISSORS

52-2880 6" (15 cm)



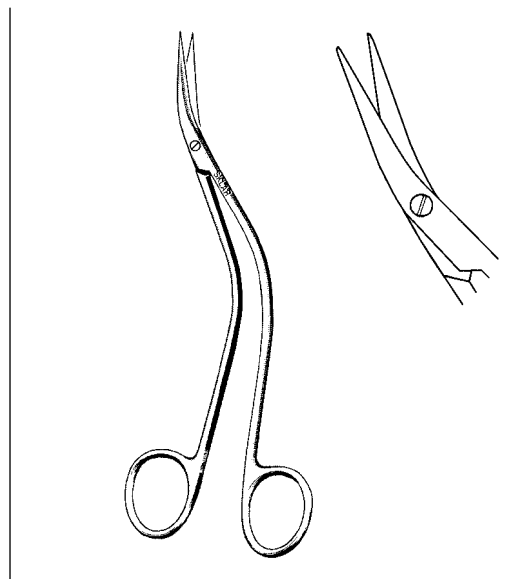
METZENBAUM DISSECTING SCISSORS DELICATE

Straight	Curved
22-1071 7"	22-1070 7"
55-9184 8" (Nelson)	55-9084 8" (Nelson)
55-9194 9" (Nelson)	55-9094 9" (Nelson)



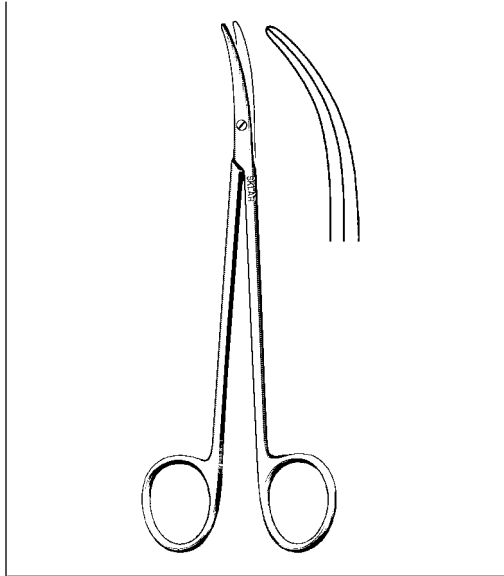
DEBAKEY VASCULAR SCISSORS

52-2885 6" Double Angular



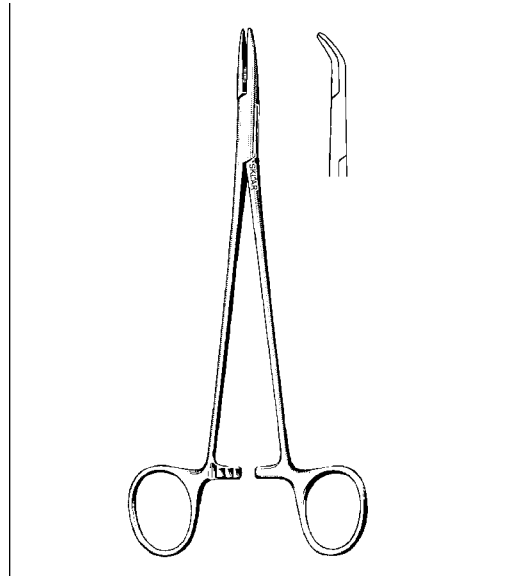
DEBAKEY VASCULAR SCISSORS

52-2888 6" Curved



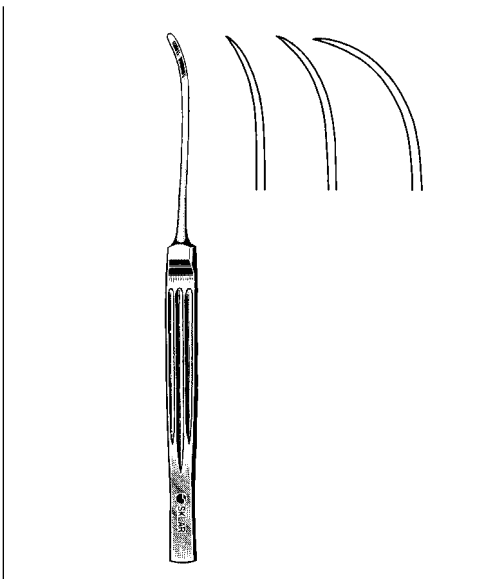
**DEBAKEY ENDARTERECTOMY
SCISSORS**

55-8488 7" (17.5 cm) Full Curve



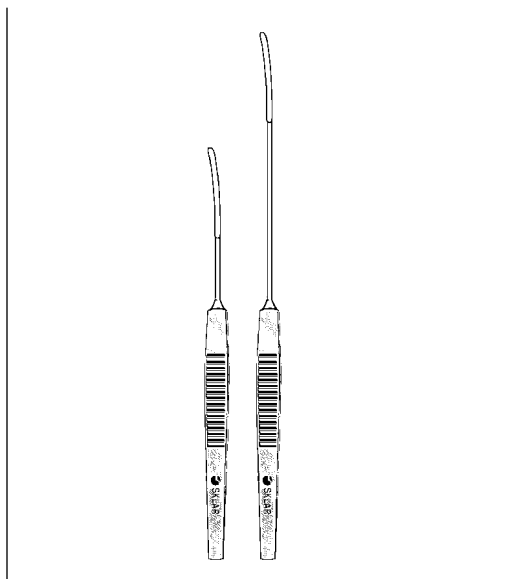
STRELI VASCULAR FORCEPS

Tissue Palpable-Angular
55-3200 Soft gripping jaw 1 mm 6"



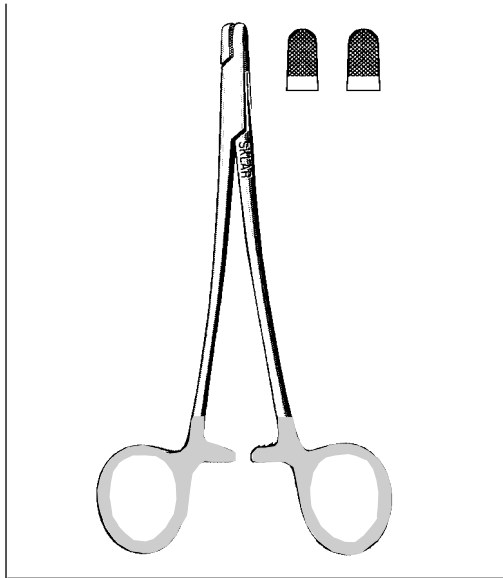
LEMMON INTIMA DISSECTORS

55-8390 6½" Slight Curve
55-8391 6½" Standard Curve
55-8392 6½" Full Curve



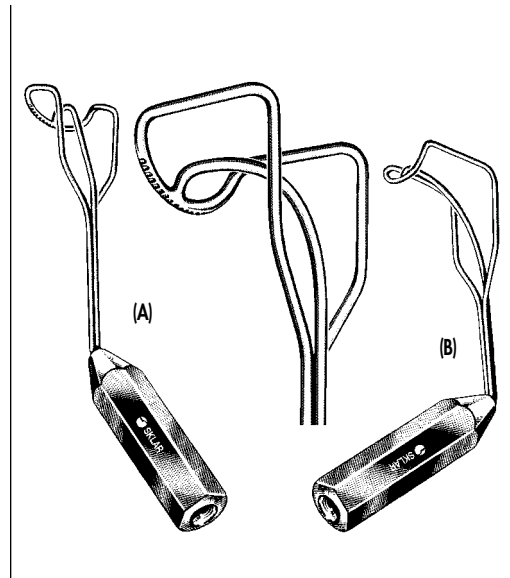
VASCULAR THROMBECTOMY SPATULA

55-8400 Vollmar 6"
55-8402 8"



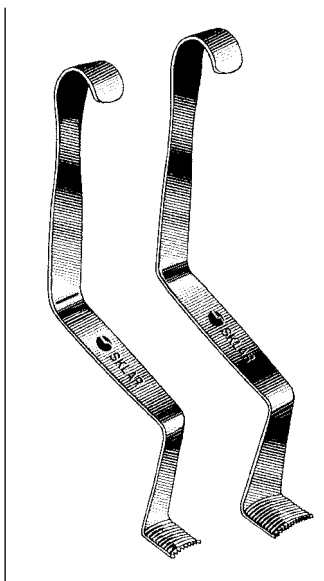
T-C SKLAR STERNAL WIRE TWISTER

21-9060 5"
21-9065 7"



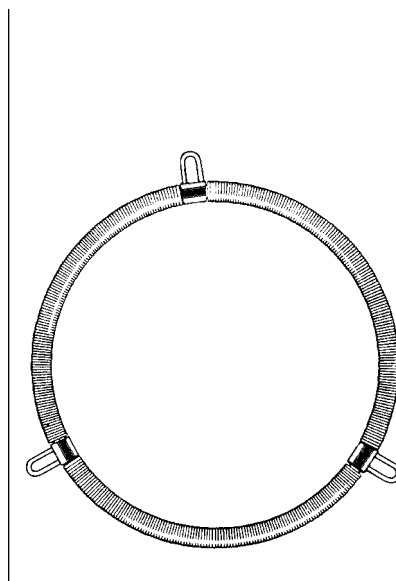
COOLEY ATRIAL VALVE RETRACTORS

55-8282 Right, small blade, 25 mm wide, 20 mm deep (A)
55-8284 Right, med. blade, 40 mm wide, 30 mm deep (A)
55-8286 Right, large blade, 50 mm wide, 35 mm deep (A)
55-8288 Left, 50 mm wide, 10mm deep (B)



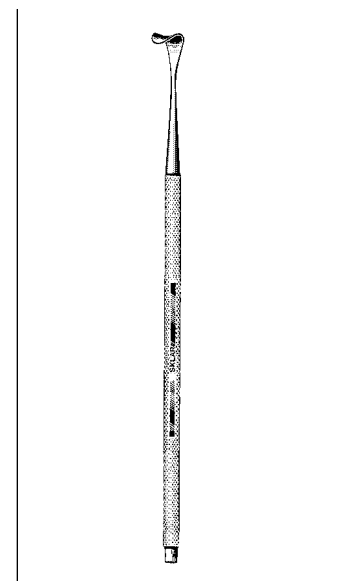
CRAWFORD AORTIC RETRACTORS

55-8290 Small, blade, 15 mm wide by 15 mm deep
55-8292 Large, blade, 22 mm wide by 20 mm deep



CRAWFORD SUTURE RING

55-8295 9" Diameter



VESSEL AND NERVE RETRACTOR

Malleable

55-8300 11 mm
55-8302 15 mm
55-8304 17 mm
55-8306 20 mm

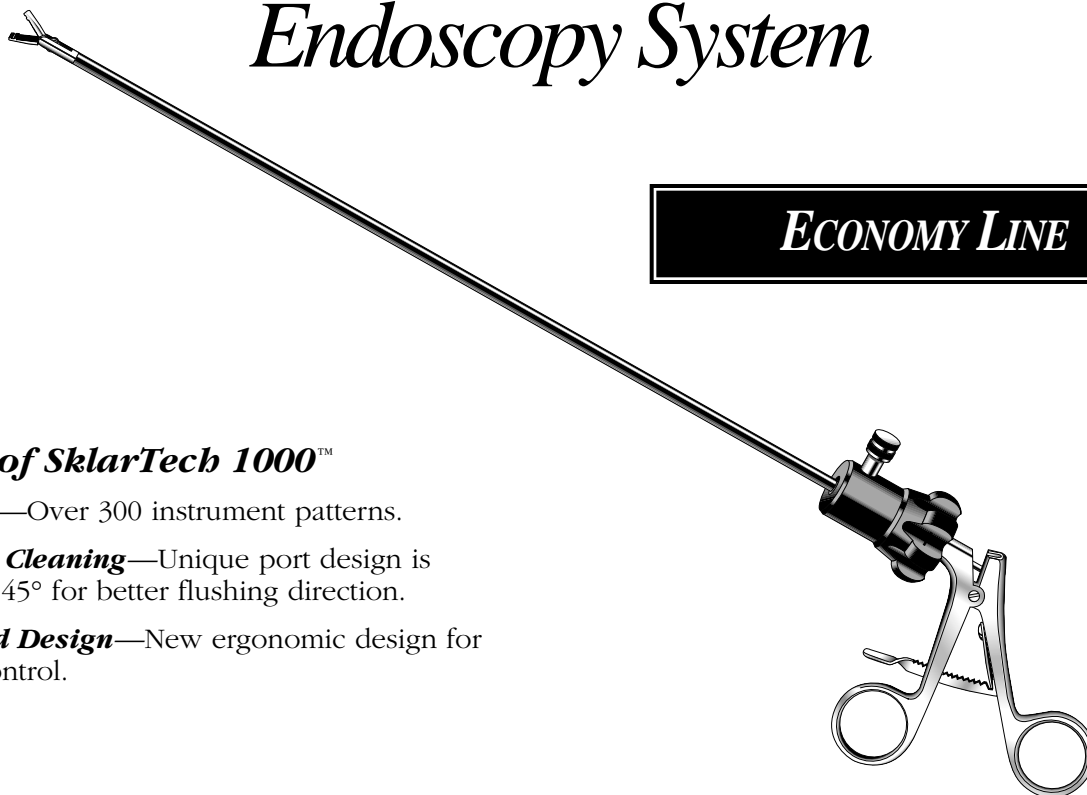


NEW!

SKLARTECH 1000™

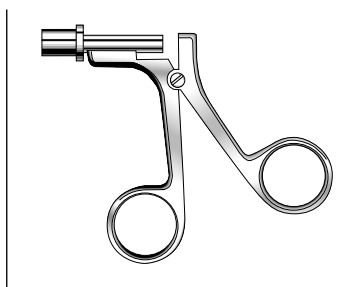
Endoscopy System

ECONOMY LINE



Benefits of SklarTech 1000™

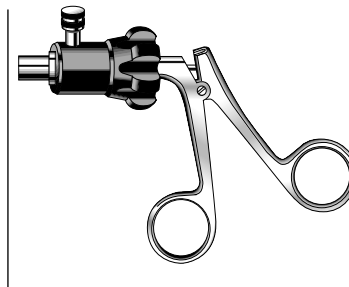
- **Selection**—Over 300 instrument patterns.
- **Superior Cleaning**—Unique port design is angled at 45° for better flushing direction.
- **Improved Design**—New ergonomic design for greater control.



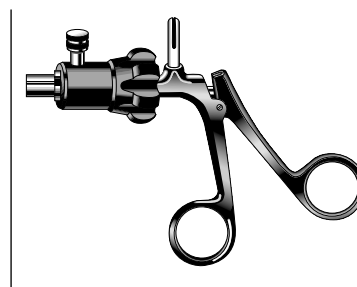
**SKLARTECH 1000™
HANDLE NON-INSULATED (A)**



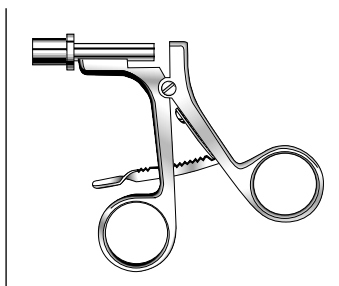
**SKLARTECH 1000™
HANDLE INSULATED (B)**



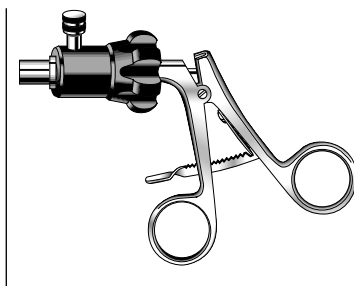
**SKLARTECH 1000™
HANDLE ROTATABLE (C)**



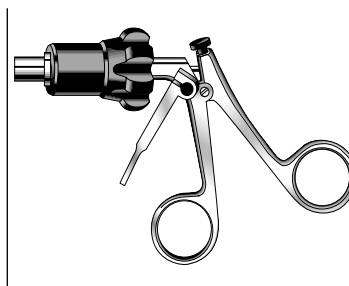
**SKLARTECH 1000™
HANDLE ROTATABLE, INSULATED (D)**



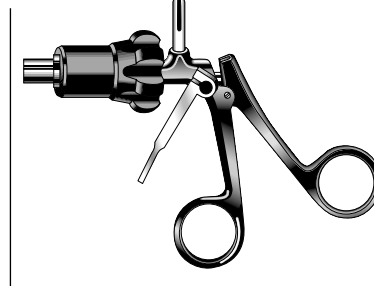
**SKLARTECH 1000™ HANDLE
NON-INSULATED WITH INSIDE
RATCHET (E)**



**SKLARTECH 1000™ HANDLE
ROTATABLE WITH INSIDE
RATCHET (F)**



**SKLARTECH 1000™ HANDLE
ROTATABLE WITH FIXATION
LEVER (G)**

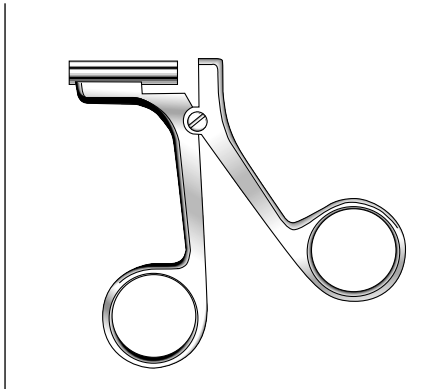


**SKLARTECH 1000™ HANDLE
ROTATABLE, INSULATED WITH
FIXATION LEVER (H)**

SKLARTECH 1000™

Endoscopy System

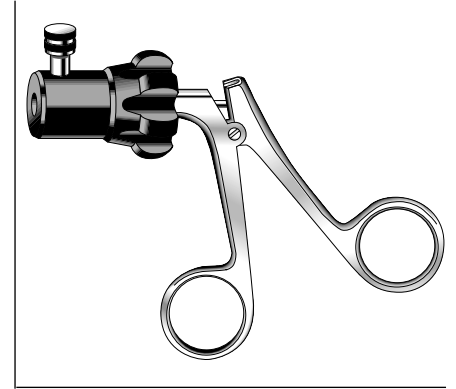
Sklar offers the most versatile Endoscopic system in the industry. With eight handle styles, the hospital can choose from over 300 different combinations. Just select any handle from below and select the appropriate tip from the following pages. The hospital receives a complete one-piece unit ready for sterilization and use.



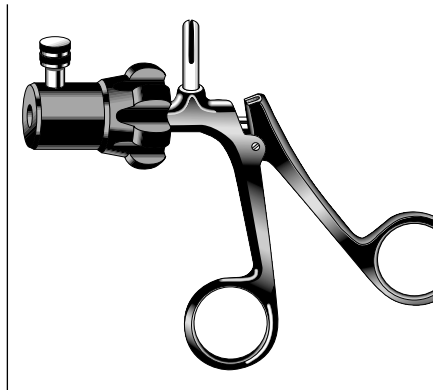
**SKLARTECH 1000™ HANDLE
NON-INSULATED (A)**



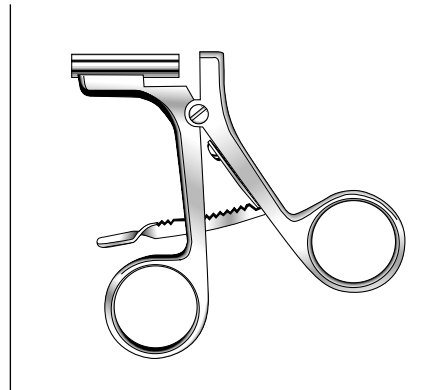
**SKLARTECH 1000™ HANDLE
INSULATED (B)**



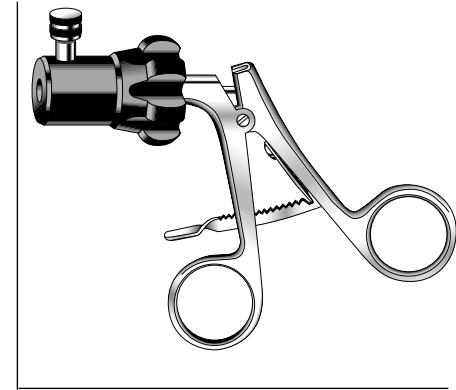
**SKLARTECH 1000™ HANDLE
ROTATABLE (C)**



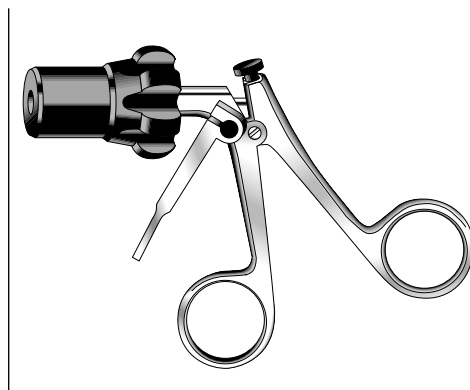
**SKLARTECH 1000™ HANDLE
ROTATABLE, INSULATED (D)**



**SKLARTECH 1000™ HANDLE
NON-INSULATED WITH INSIDE
RATCHET (E)**



**SKLARTECH 1000™ HANDLE
ROTATABLE WITH INSIDE
RATCHET (F)**



**SKLARTECH 1000™ HANDLE
ROTATABLE WITH FIXATION
LEVER (G)**



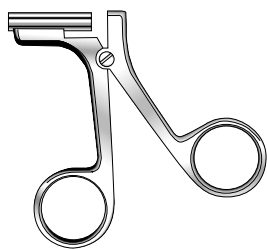
**SKLARTECH 1000™ HANDLE
ROTATABLE, INSULATED WITH
FIXATION LEVER (H)**

ENDOSCOPY

5 MM

Ordering Instructions for the SklarTech 1000™ System

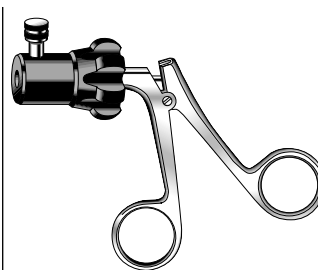
- (1) Select any jaw.
- (2) Select available handle ('A' thru 'H').
- (3) You will receive your Jaw and Handle combination in a pre-assembled, one piece, non-detachable instrument, ready for sterilization and use.



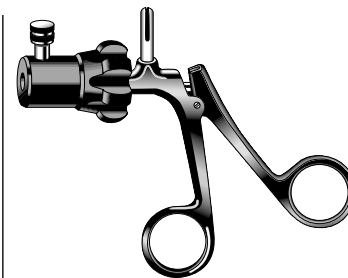
**SKLARTECH 1000™ HANDLE
NON-INSULATED (A)**



**SKLARTECH 1000™ HANDLE
INSULATED (B)**

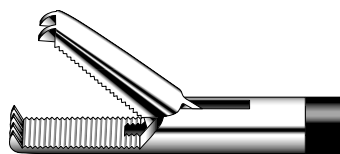


**SKLARTECH 1000™ HANDLE
ROTATABLE (C)**



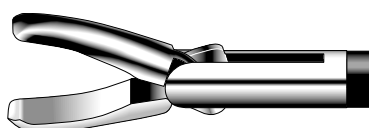
**SKLARTECH 1000™ HANDLE
ROTATABLE, INSULATED (D)**

COBRA GRASPING FORCEPS



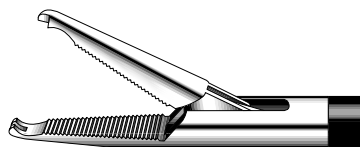
33 cm long 5 mm diameter
 31-2530B 31-2530F
 31-2530C 31-2530G
 31-2530D 31-2530H
 31-2530E

GRASPING FORCEPS



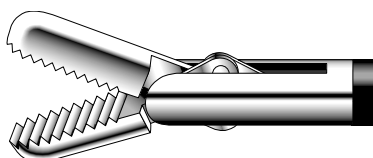
Blunt 33 cm long 5 mm diameter
 31-2532B 31-2532F
 31-2532C 31-2532G
 31-2532D 31-2532H
 31-2532E

GRASPING FORCEPS



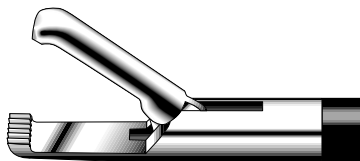
33 cm long 5 mm diameter
 31-2534B 31-2534F
 31-2534C 31-2534G
 31-2534D 31-2534H
 31-2534E

DISSECTING AND GRASPING FORCEPS



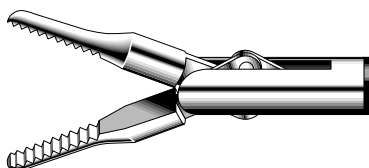
Blunt 33 cm long 5 mm diameter
 31-2536B 31-2536F
 31-2536C 31-2536G
 31-2536D 31-2536H
 31-2536E

ALLIS GRASPING FORCEPS



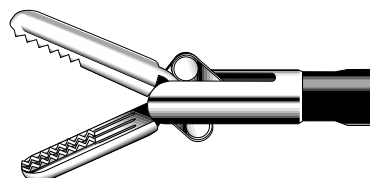
33 cm long 5 mm diameter
 31-2538B 31-2538F
 31-2538C 31-2538G
 31-2538D 31-2538H
 31-2538E

DOLPHIN DISSECTING FORCEPS



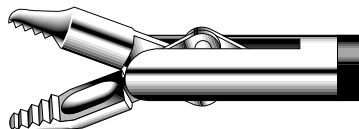
33 cm long 5 mm diameter
 31-2540B 31-2540F
 31-2540C 31-2540G
 31-2540D 31-2540H
 31-2540E

DEBAKEY DISSECTING AND GRASPING FORCEPS



33 cm long 5 mm diameter
 31-2542B 31-2542F
 31-2542C 31-2542G
 31-2542D 31-2542H
 31-2542E

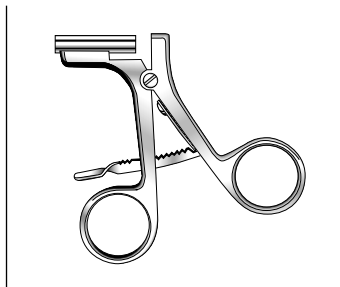
DISSECTING AND GRASPING FORCEPS



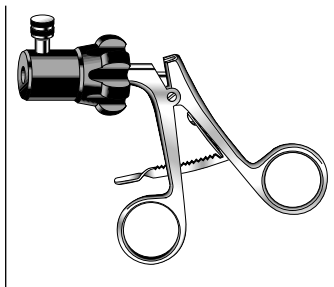
Tapered End 33 cm long 5 mm diameter
 31-2544B 31-2544F
 31-2544C 31-2544G
 31-2544D 31-2544H
 31-2544E

Ordering Instructions for the SklarTech 1000™ System

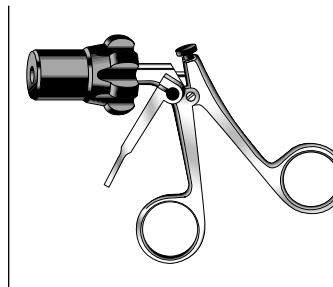
- (1) Select any jaw. (2) Select available handle ('A' thru 'H').
- (3) You will receive your Jaw and Handle combination in a pre-assembled, one piece, non-detachable instrument, ready for sterilization and use.



**SKLARTECH 1000™ HANDLE
NON-INSULATED WITH INSIDE
RATCHET (E)**



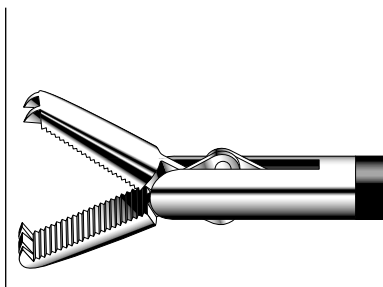
**SKLARTECH 1000™ HANDLE
ROTATABLE WITH INSIDE RATCHET
(F)**



**SKLARTECH 1000™ HANDLE
ROTATABLE WITH FIXATION LEVER
(G)**



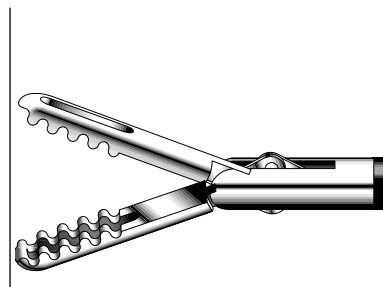
**SKLARTECH 1000™ HANDLE
ROTATABLE, INSULATED WITH
FIXATION LEVER (H)**



COBRA GRASPING FORCEPS

Double Action 33 cm long
5 mm diameter

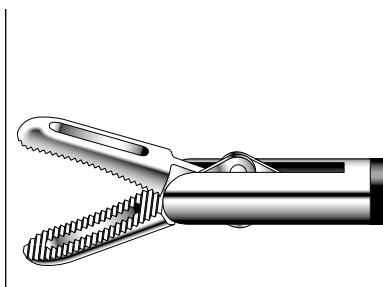
31-2550B 31-2550F
31-2550C 31-2550G
31-2550D 31-2550H
31-2550E



SCHERTL FENESTRATED GRASPING FORCEPS

33 cm long 5 mm diameter

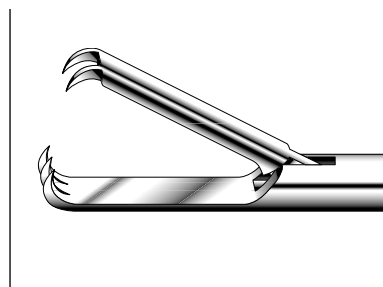
31-2552B 31-2552F
31-2552C 31-2552G
31-2552D 31-2552H
31-2552E



FENESTRATED GRASPING FORCEPS

33 cm long 5 mm diameter

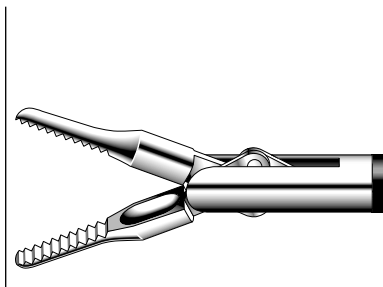
31-2554B 31-2554F
31-2554C 31-2554G
31-2554D 31-2554H
31-2554E



CLAW FORCEPS WITH RETAINING SPRING

33 cm long 5 mm diameter

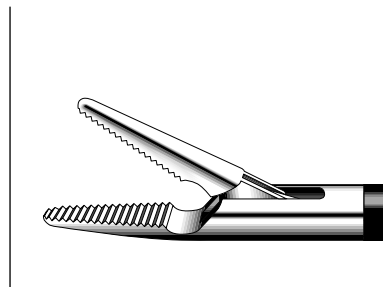
31-2556A



DOLPHIN DISSECTING AND GRASPING FORCEPS WITH SPOON

33 cm long 5 mm diameter

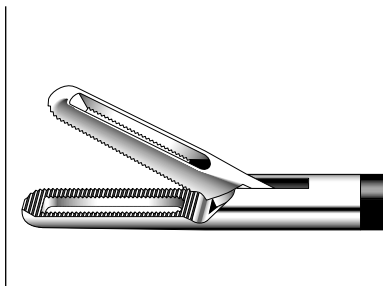
31-2558B 31-2558F
31-2558C 31-2558G
31-2558D 31-2558H
31-2558E



NEEDLE NOSE GRASPING FORCEPS

33 cm long 5 mm diameter

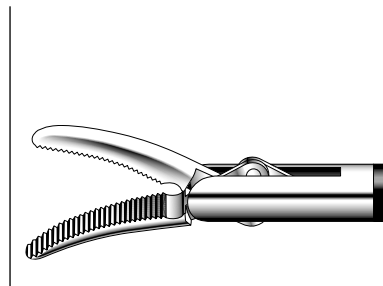
31-2560B 31-2560F
31-2560C 31-2560G
31-2560D 31-2560H
31-2560E



DUCK BILL DISSECTING AND GRASPING FORCEPS

33 cm long 5 mm diameter

31-2562B 31-2562F
31-2562C 31-2562G
31-2562D 31-2562H
31-2562E



MARYLAND DISSECTOR

33 cm long 5 mm diameter

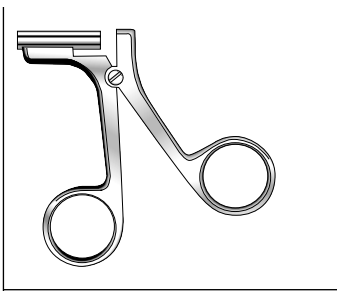
31-2564B 31-2564F
31-2564C 31-2564G
31-2564D 31-2564H
31-2564E

ENDOSCOPY

5 MM

Ordering Instructions for the SklarTech 1000™ System

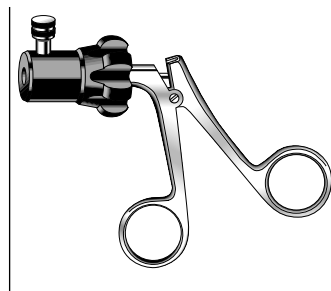
- (1) Select any jaw. (2) Select available handle ('A' thru 'H').
- (3) You will receive your Jaw and Handle combination in a pre-assembled, one piece, non-detachable instrument, ready for sterilization and use.



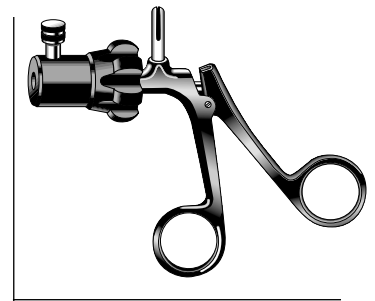
**SKLARTECH 1000™ HANDLE
NON-INSULATED (A)**



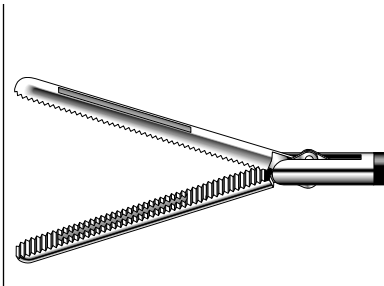
**SKLARTECH 1000™ HANDLE
INSULATED (B)**



**SKLARTECH 1000™ HANDLE
ROTATABLE (C)**

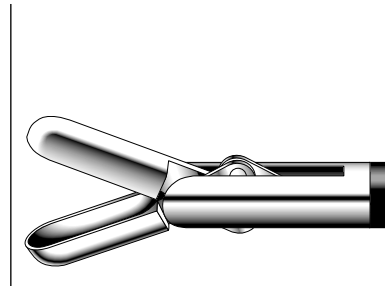


**SKLARTECH 1000™ HANDLE
ROTATABLE, INSULATED (D)**



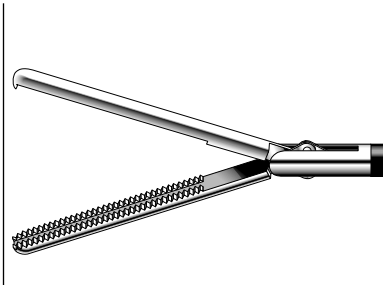
DORSEY INTESTINAL FORCEPS

33 cm long 5 mm diameter
Jaw 30 mm long
31-2570B 31-2570F
31-2570C 31-2570G
31-2570D 31-2570H
31-2570E



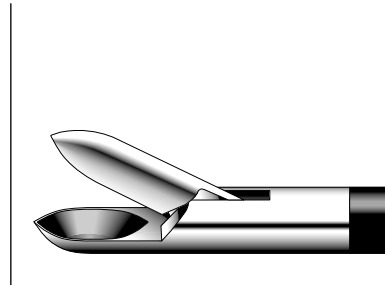
BIOSPY FORCEPS SPOON JAWS

33 cm long 5 mm diameter
31-2572A
31-2572B
31-2572C
31-2572D



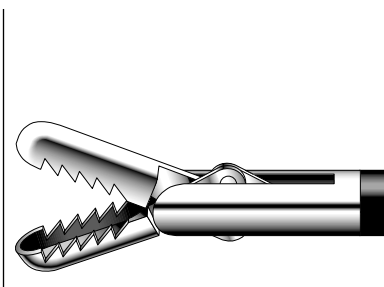
DEBAKEY ATRAUMATIC INTESTINAL FORCEPS

33 cm long 5 mm diameter
Jaw 30 mm long
31-2574B 31-2574F
31-2574C 31-2574G
31-2574D 31-2574H
31-2574E



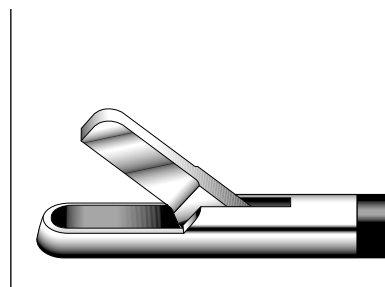
BLAKESLEY BIOSPY FORCEPS

33 cm long 5 mm diameter
31-2576A
31-2576B
31-2576C
31-2576D



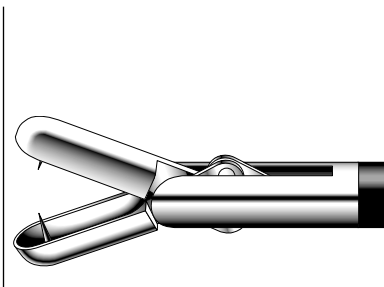
GRASPING BIOSPY FORCEPS

33 cm long 5 mm diameter
31-2578A
31-2578B
31-2578C
31-2578D



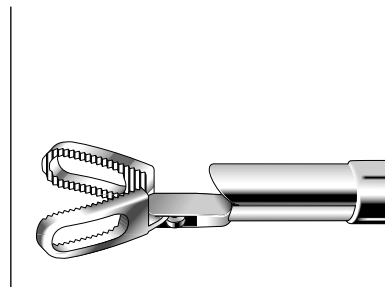
BIOSPY PUNCH FORCEPS CUT-THRU TYPE

33 cm long 5 mm diameter
31-2580A
31-2580B
31-2580C
31-2580D



BIOSPY FORCEPS SPOON JAWS WITH PIN

33 cm long 5 mm diameter
31-2582A
31-2582B
31-2582C
31-2582D



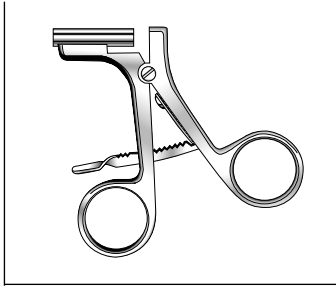
FIXATION CLAMP

33 cm long 5 mm diameter
31-2584E

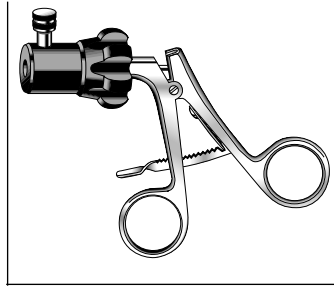
Ordering Instructions for the SklarTech 1000™ System

- (1) Select any jaw.
- (2) Select available handle ('A' thru 'H').
- (3) You will receive your Jaw and Handle combination in a pre-assembled, one piece, non-detachable instrument, ready for sterilization and use.

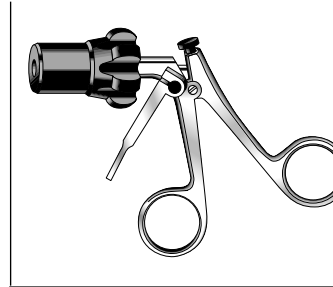
ENDOSCOPY 5 MM



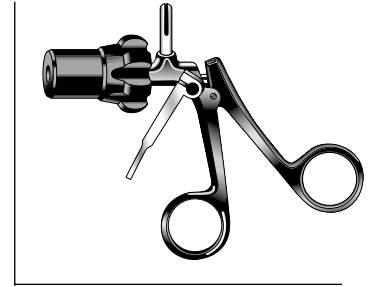
SKLARTECH 1000™ HANDLE NON-INSULATED WITH INSIDE RATCHET (E)



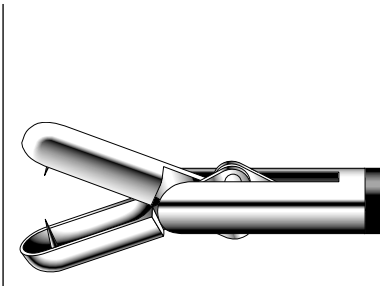
SKLARTECH 1000™ HANDLE ROTATABLE WITH INSIDE RATCHET (F)



SKLARTECH 1000™ HANDLE ROTATABLE WITH FIXATION LEVER (G)

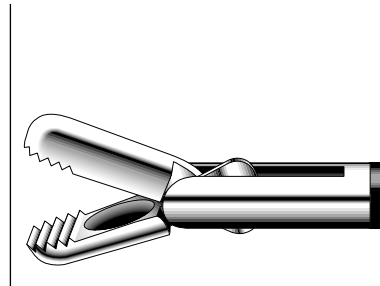


SKLARTECH 1000™ HANDLE ROTATABLE, INSULATED WITH FIXATION LEVER (H)



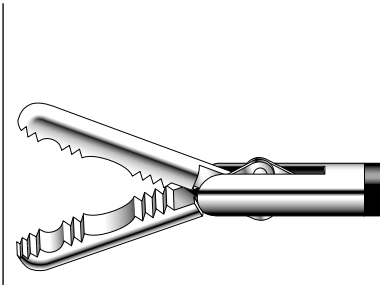
BIOPSY FORCEPS WITH PIN AND RETAINING SPRING

33 cm long 5 mm diameter
 31-2590B 31-2590F
 31-2590C 31-2590G
 31-2590D 31-2590H
 31-2590E



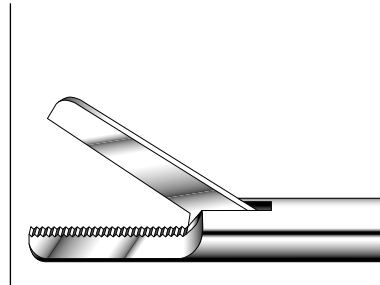
DISSECTING AND GRASPING FORCEPS

Blunt with Spoon 33 cm long
 5 mm diameter
 31-2592B 31-2592F
 31-2592C 31-2592G
 31-2592D 31-2592H
 31-2592E



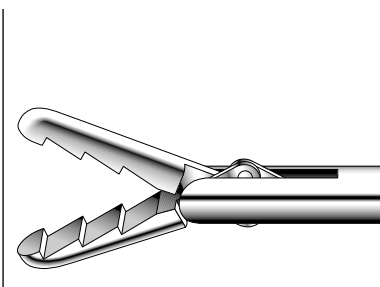
HEAVY DUTY GRASPING FORCEPS (FUNDUS)

33 cm long 5 mm diameter
 31-2594B 31-2594F
 31-2594C 31-2594G
 31-2594D 31-2594H
 31-2594E



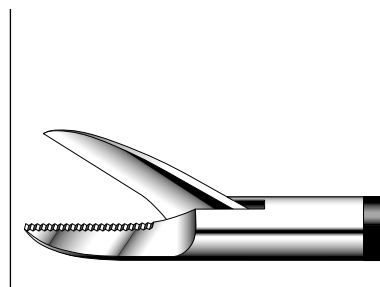
PERITONEAL SCISSORS

Serrated jaws, Blunt, Straight 33 cm long
 5 mm diameter
 31-2596A
 31-2596B
 31-2596C
 31-2596D



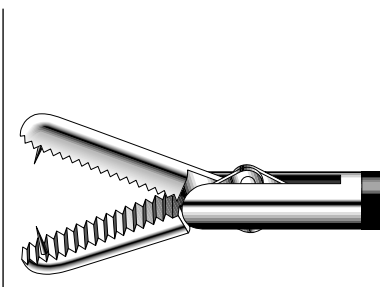
ALLIGATOR GRASPING FORCEPS

33 cm long 5 mm diameter
 31-2598B 31-2598F
 31-2598C 31-2598G
 31-2598D 31-2598H
 31-2598E



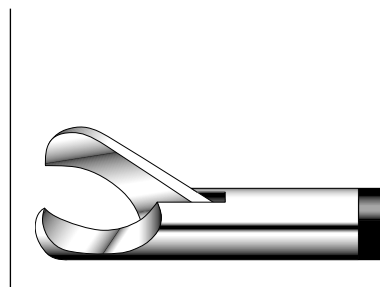
PERITONEAL SCISSORS

Serrated jaws, Sharp tips, Straight
 33 cm long 5 mm diameter
 31-2600A
 31-2600B
 31-2600C
 31-2600D



GRASPING FORCEPS WITH PIN

33 cm long 5 mm diameter
 31-2602B 31-2602F
 31-2602C 31-2602G
 31-2602D 31-2602H
 31-2602E



HOOK SCISSORS

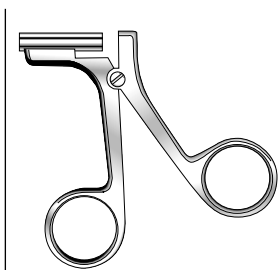
33 cm long 5 mm diameter
 31-2604A
 31-2604B
 31-2604C
 31-2604D

ENDOSCOPY

5/10 MM

Ordering Instructions for the SklarTech 1000™ System

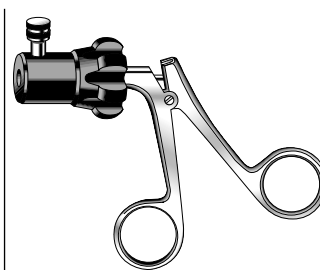
- (1) Select any jaw.
- (2) Select available handle ('A' thru 'H').
- (3) You will receive your Jaw and Handle combination in a pre-assembled, one piece, non-detachable instrument, ready for sterilization and use.



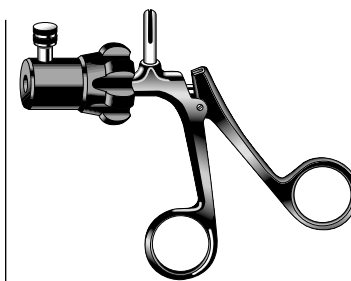
**SKLARTECH 1000™ HANDLE
NON-INSULATED (A)**



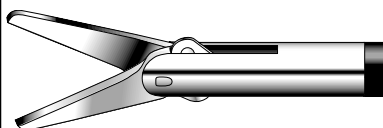
**SKLARTECH 1000™ HANDLE
INSULATED (B)**



**SKLARTECH 1000™ HANDLE
ROTATABLE (C)**

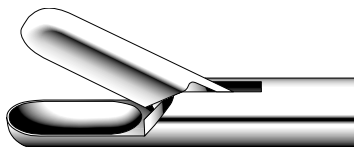


**SKLARTECH 1000™ HANDLE
ROTATABLE, INSULATED (D)**



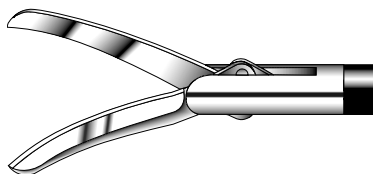
METZENBAUM SCISSORS

Double action jaws, Straight
33 cm long 5 mm diameter
31-2620A
31-2620B
31-2620C
31-2620D



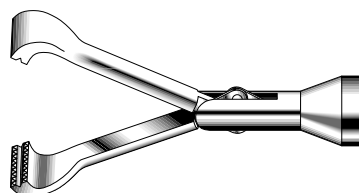
OPERATING SPOON WITH RETAINING SPOON

33 cm long 10 mm diameter
31-2622A
31-2622C



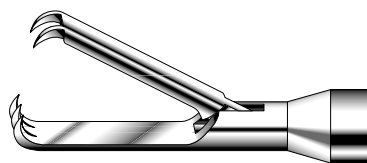
METZENBAUM SCISSORS

Double action jaws, Curved
33 cm long 5 mm diameter
31-2624A
31-2624B
31-2624C
31-2624D



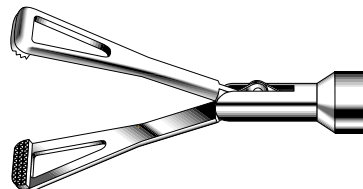
ALLIS GRASPING FORCEPS

33 cm long 10 mm diameter
31-2626A 31-2626G
31-2626C 31-2626H
31-2626E
31-2626F



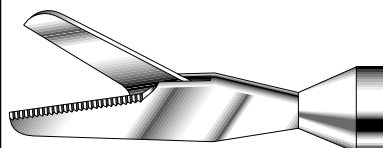
CLAW FORCEPS WITH SPRING RETAINING

33 cm long 10 mm diameter
31-2628A



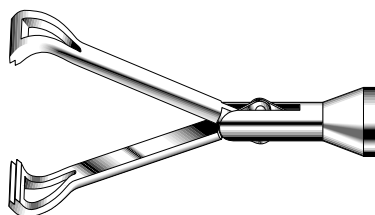
DUVAL GRASPING FORCEPS

33 cm long 10 mm diameter
31-2630A 31-2630G
31-2630C 31-2630H
31-2630E
31-2630F



OPERATING SCISSORS

33 cm long 10 mm diameter
31-2632A
31-2632B

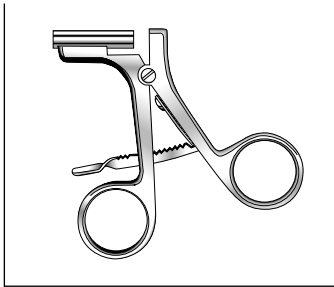


BABCOCK GRASPING FORCEPS

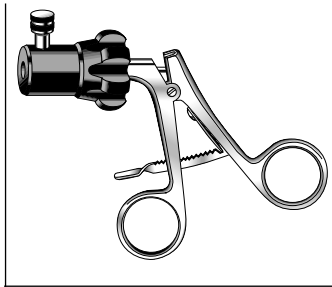
33 cm long 10 mm diameter
31-2634A 31-2634G
31-2634C 31-2634H
31-2634E
31-2634F

Ordering Instructions for the SklarTech 1000™ System

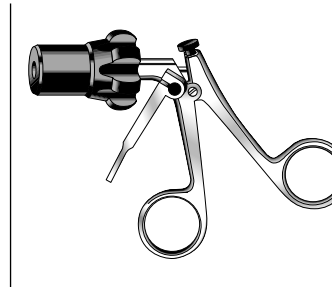
- (1) Select any jaw.
- (2) Select available handle ('A' thru 'H').
- (3) You will receive your Jaw and Handle combination in a pre-assembled, one piece, non-detachable instrument, ready for sterilization and use.



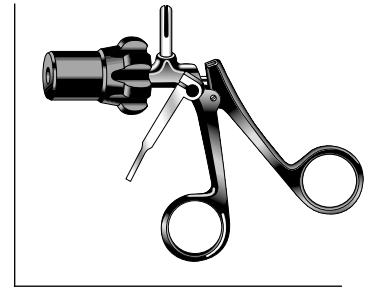
**SKLARTECH 1000™ HANDLE
NON-INSULATED WITH INSIDE
RATCHET (E)**



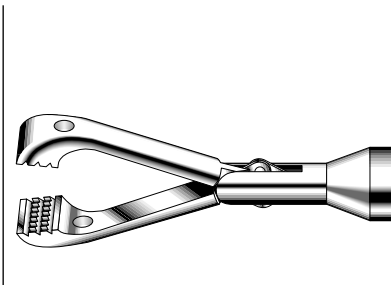
**SKLARTECH 1000™ HANDLE
ROTATABLE WITH INSIDE RATCHET
(F)**



**SKLARTECH 1000™ HANDLE
ROTATABLE WITH FIXATION LEVER
(G)**

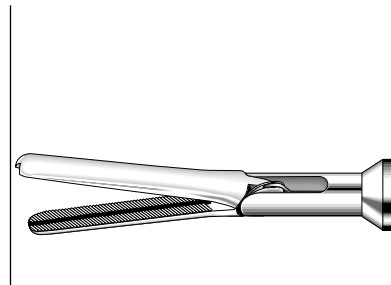


**SKLARTECH 1000™ HANDLE ROTATABLE,
INSULATED WITH FIXATION
LEVER (H)**



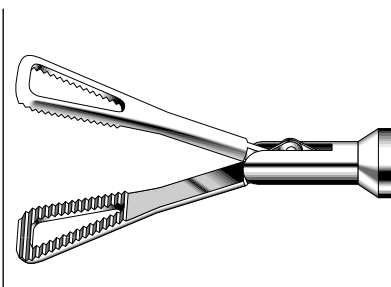
MARC GRASPING FORCEPS

33 cm long 10 mm diameter
31-2640A 31-2640G
31-2640C 31-2640H
31-2640E
31-2640F



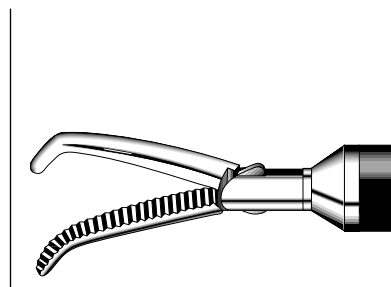
GLASSMANN INTESTINAL FORCEPS

33 cm long 10 mm diameter
31-2642E
31-2642F
31-2642G



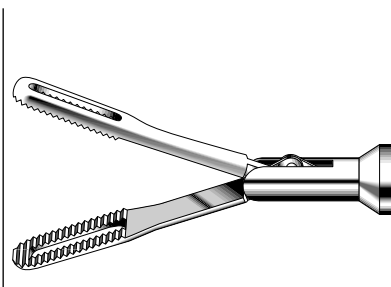
PENNINGTON GRASPING FORCEPS

33 cm long 10 mm diameter
31-2644E
31-2644F
31-2644G



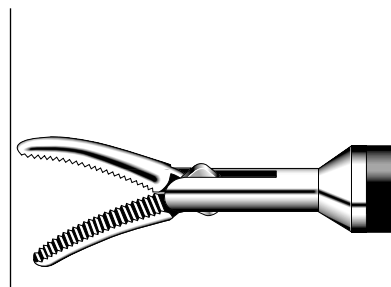
MARYLAND DISSECTOR

Strongly curved, Unipolar 33 cm long
10 mm diameter
31-2646B
31-2646D



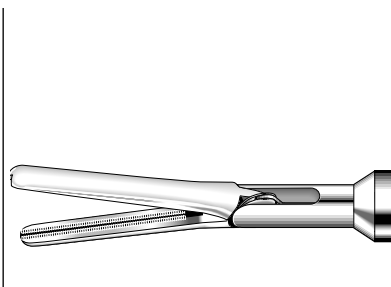
FOERSTER GRASPING FORCEPS

33 cm long 10 mm diameter
31-2648E
31-2648F
31-2648G



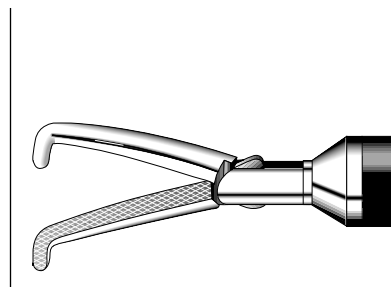
MARYLAND DISSECTOR

Strongly curved
33 cm long 10 mm diameter
31-2650B
31-2650D



DEBAKEY INTESTINAL FORCEPS

33 cm long 10 mm diameter
31-2652E
31-2652F
31-2652G



MIXTER DISSECTOR

Right-angled
33 cm long 10 mm diameter
31-2654B
31-2654D

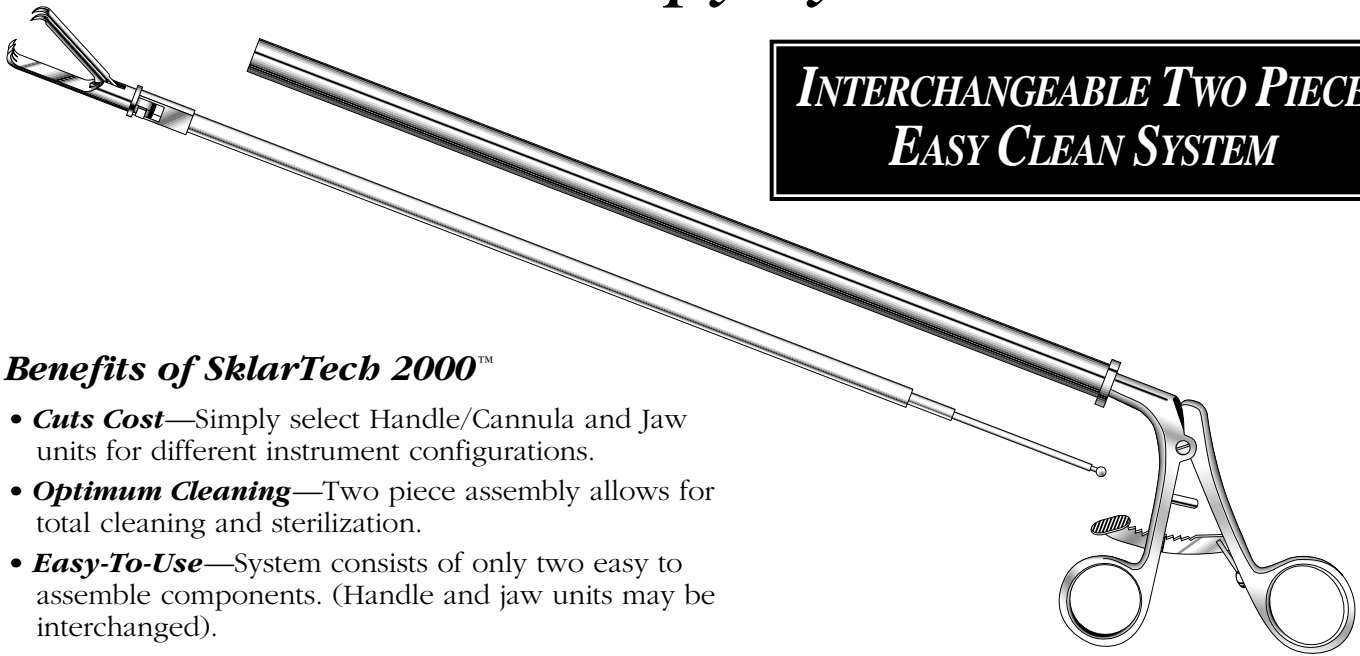


NEW!

SKLARTECH 2000™

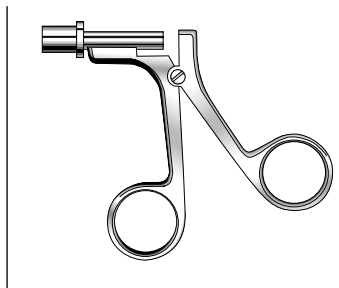
Endoscopy System

**INTERCHANGEABLE TWO PIECE
EASY CLEAN SYSTEM**



Benefits of SklarTech 2000™

- **Cuts Cost**—Simply select Handle/Cannula and Jaw units for different instrument configurations.
- **Optimum Cleaning**—Two piece assembly allows for total cleaning and sterilization.
- **Easy-To-Use**—System consists of only two easy to assemble components. (Handle and jaw units may be interchanged).



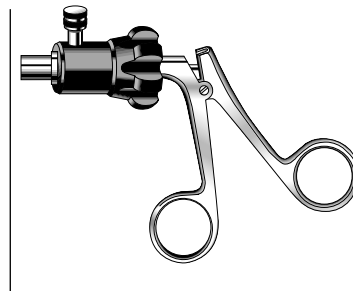
SKLARTECH 2000™ HANDLE NON-INSULATED (A)

31-4450 Handle with Cannula



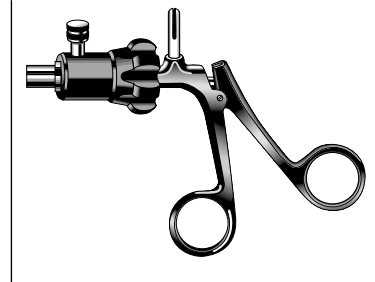
SKLARTECH 2000™ HANDLE INSULATED (B)

31-4452 Handle with Cannula



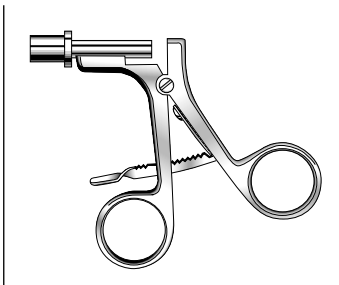
SKLARTECH 2000™ HANDLE ROTATABLE (C)

31-4454 Handle with Cannula



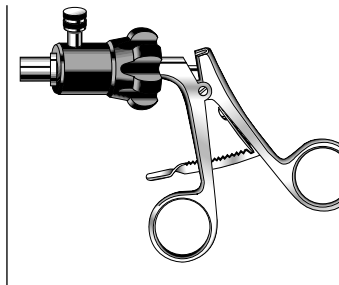
SKLARTECH 2000™ HANDLE ROTATABLE, INSULATED (D)

31-4456 Handle with Cannula



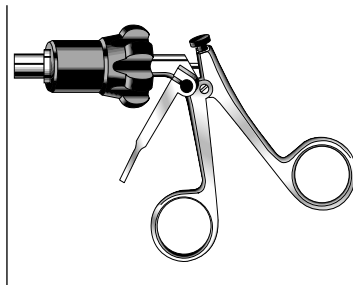
SKLARTECH 2000™ HANDLE NON-INSULATED WITH INSIDE RATCHET (E)

31-4458 Handle with Cannula



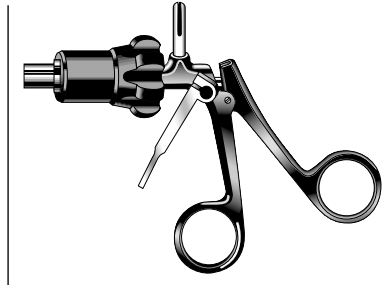
SKLARTECH 2000™ HANDLE ROTATABLE WITH INSIDE RATCHET (F)

31-4460 Handle with Cannula



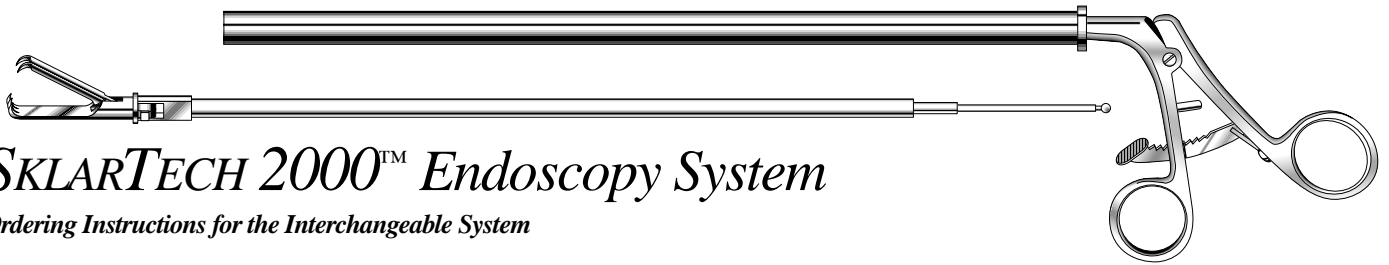
SKLARTECH 2000™ HANDLE ROTATABLE WITH FIXATION LEVER (G)

31-4462 Handle with Cannula



SKLARTECH 2000™ HANDLE ROTATABLE, INSULATED WITH FIXATION LEVER (H)

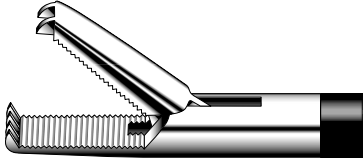
31-4464 Handle with Cannula



SKLARTECH 2000™ Endoscopy System

Ordering Instructions for the Interchangeable System

- Order any handle from page 442. You will receive the handle with attached cannula.
- Order any jaw from the following two pages.
- You will receive your Jaw/Stylet and Handle/Cannula individually packaged. Insert the Jaw into the cannula, sterilize and the instrument is ready-to-use!



COBRA GRASPING FORCEPS
31-4500 33 cm long
5 mm diameter

Available Handles 'A' thru 'H'



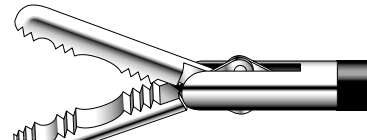
MARYLAND DISSECTOR
31-4502 33 cm long
5 mm diameter

Available Handles 'A' thru 'H'



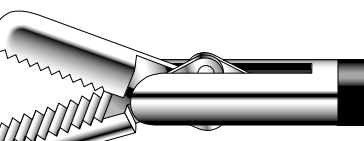
FENESTRATED GRASPING FORCEPS
31-4504 33 cm long
5 mm diameter

Available Handles 'A' thru 'H'



HEAVY DUTY GRASPING FORCEPS (FUNDUS)
31-4506 33 cm long
5 mm diameter
Unipolar

Available Handles 'A' thru 'H'



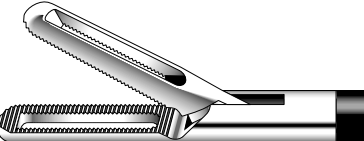
GRASPING FORCEPS
31-4508 Blunt 33 cm long
5 mm diameter

Available Handles 'A' thru 'H'



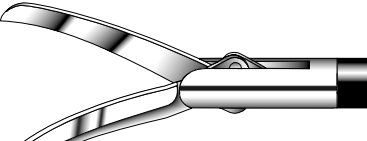
METZENBAUM SCISSORS
31-4510 Double action jaws
Straight
33 cm long
5 mm diameter

Available Handles 'A' thru 'H'



DUCK BILL DISSECTING AND GRASPING FORCEPS
31-4512 33 cm long
5 mm diameter

Available Handles 'A' thru 'H'



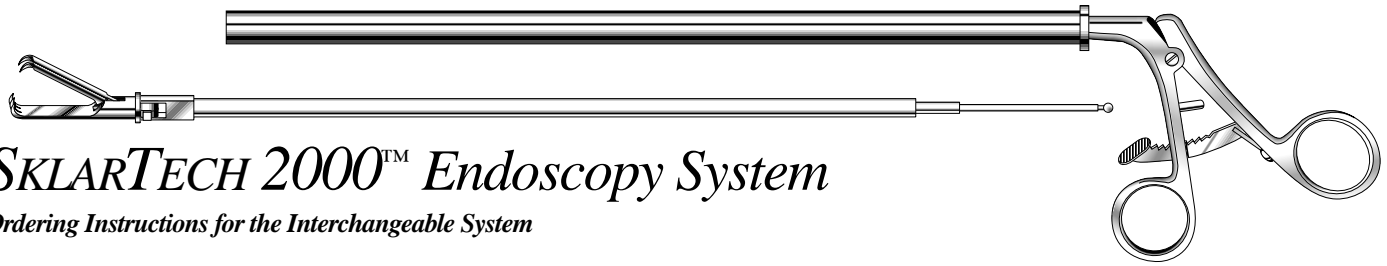
METZENBAUM SCISSORS
31-4514 Double action jaws
Curved
33 cm long
5 mm diameter

Available Handles 'A' thru 'H'

Jaws are Interchangeable with all Handles on Page 442.

ENDOSCOPY

10 MM



SKLARTECH 2000™ Endoscopy System


Ordering Instructions for the Interchangeable System

- Order any handle from page 442. You will receive the handle with attached cannula.
- Order any jaw from this page.
- You will receive your Jaw/Stylet and Handle/Cannula individually packaged. Insert the Jaw into the cannula, sterilize and the instrument is ready-to-use!



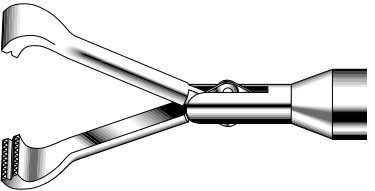
ALLIS GRASPING FORCEPS
31-4520 33 cm long
10 mm diameter

Available Handles 'A' thru 'H'



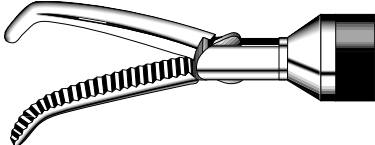
DEBAKEY INTESTINAL FORCEPS
31-4522 33 cm long
10 mm diameter

Available Handles 'A' thru 'H'



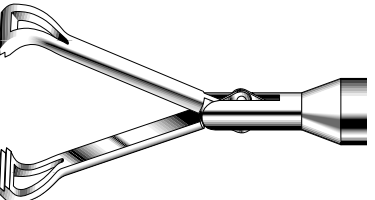
DUVAL GRASPING FORCEPS
31-4524 33 cm long
10 mm diameter

Available Handles 'A' thru 'H'



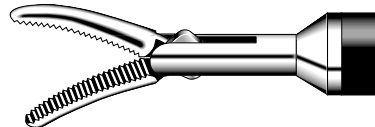
MARYLAND DISSECTOR
31-4526 Strongly curved, Unipolar
33 cm long
10 mm diameter

Available Handles 'A' thru 'H'



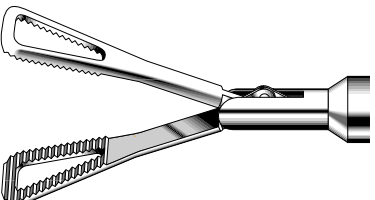
BABCOCK GRASPING FORCEPS
31-4528 33 cm long
10 mm diameter

Available Handles 'A' thru 'H'



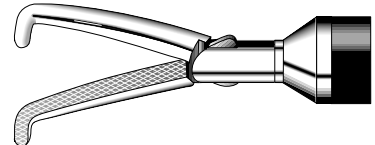
MARYLAND DISSECTOR
31-4530 Slightly curved
33 cm long
10 mm diameter

Available Handles 'A' thru 'H'



PENNINGTON GRASPING FORCEPS
31-4532 33 cm long
10 mm diameter

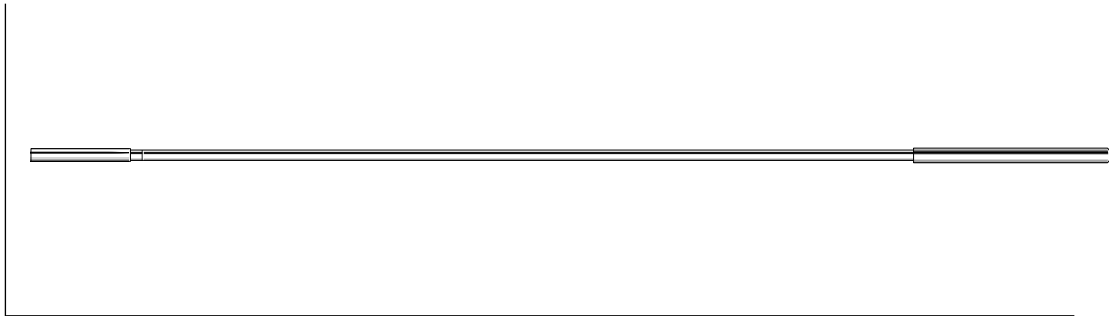
Available Handles 'A' thru 'H'



MIXTER DISSECTOR
31-4534 Right-angled
33 cm long
10 mm diameter

Available Handles 'A' thru 'H'

Jaws are Interchangeable with all Handles on Page 442.



KNOT GUIDE

31-4550



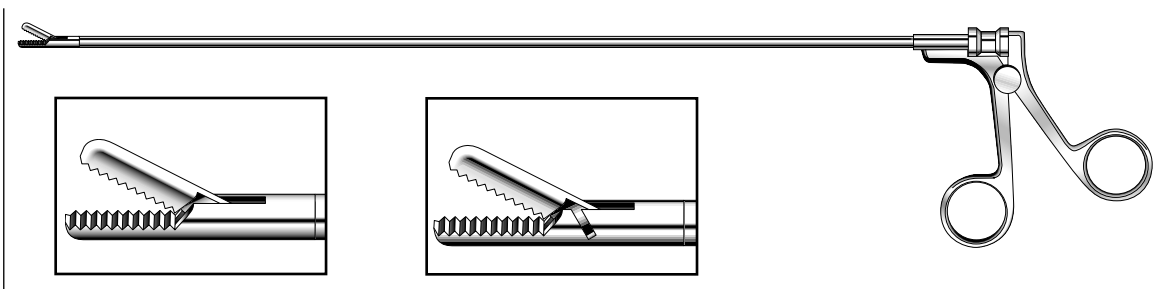
APPLICATOR

For use with 3 mm Needle Holder with Luer-Lock Cleaning Port
31-4558



NEEDLE HOLDER

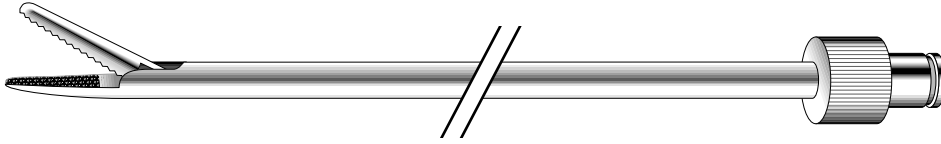
With Luer-Lock Cleaning Port
31-4570 Length 33 cm 3 mm Diameter



NEEDLE HOLDER

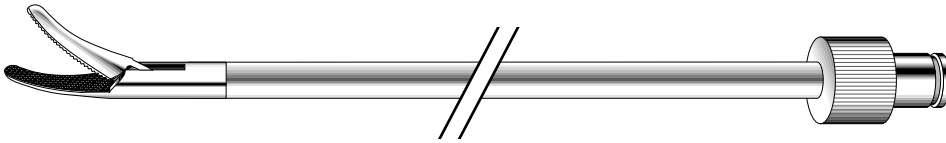
With Luer-Lock Cleaning Port
31-4572 Length 33 cm 5 mm Diameter

With Suture Cutter and Luer-Lock Cleaning Port
31-4574 Length 33 cm 5 mm Diameter



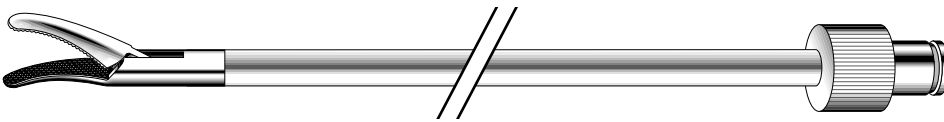
NEEDLE HOLDER TIP

31-5002 5.0 mm Straight



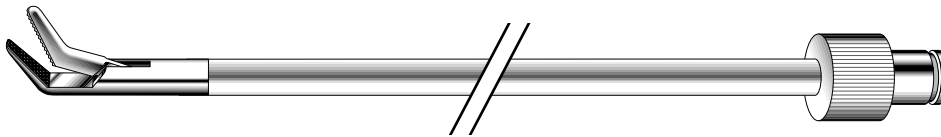
NEEDLE HOLDER TIP

31-5004 5.0 mm Right



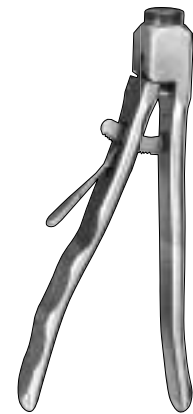
NEEDLE HOLDER TIP

31-5006 5.0 mm Left



NEEDLE HOLDER TIP

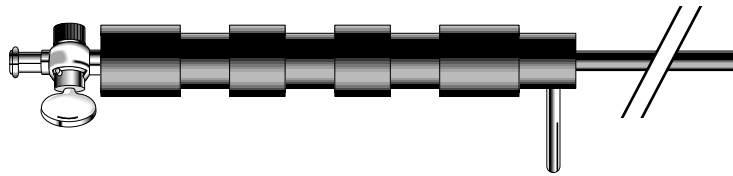
31-5008 10.0 mm Curved on flat



AXIAL HANDLE

For Needle Holder Tips
On This Page

31-5000



COAGULATION SUCTION TUBE WITH VALVE

Unipolar

SPATULA ELECTRODE

31-2215 33 cm long
5 mm Diameter
Hollow Tube



'J' HOOK ELECTRODE

31-2220 33 cm long
5 mm Diameter
Hollow Tube



'L' HOOK ELECTRODE

31-2222 33 cm long
5 mm Diameter
Hollow Tube



BUTTON ELECTRODE WITH OPEN END

31-2225 33 cm long
5 mm Diameter
Hollow Tube



COAGULATION ELECTRODE

Unipolar

COAGULATION SPATULA ELECTRODE

31-2230 33 cm long
5 mm Diameter
Solid Shaft



'J' HOOK COAGULATION ELECTRODE

31-2234 33 cm long
5 mm Diameter
Solid Shaft



'L' HOOK COAGULATION ELECTRODE

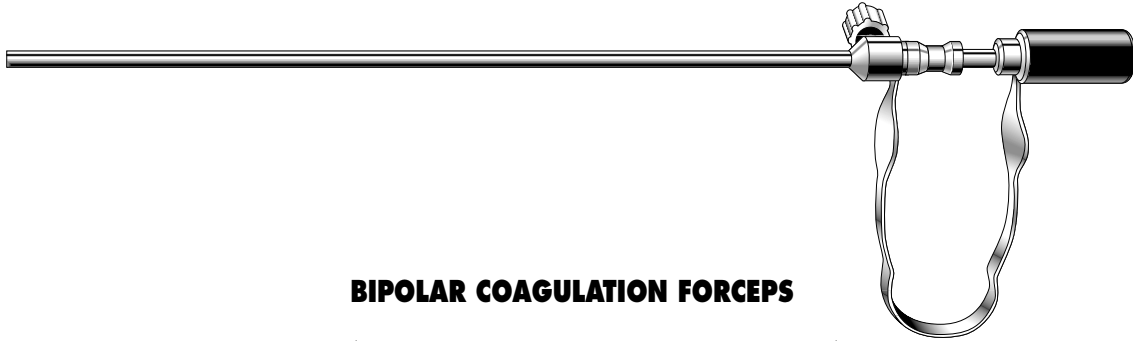
31-2232 33 cm long
5 mm Diameter
Solid Shaft



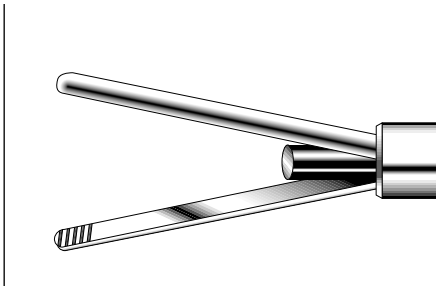
COAGULATION BUTTON ELECTRODE

31-2236 33 cm long
5 mm Diameter
Solid Shaft



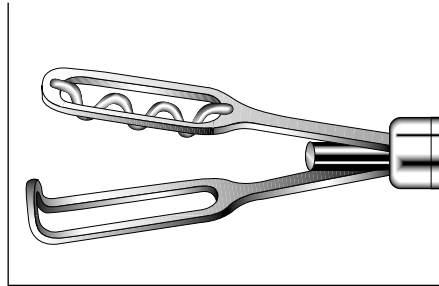


BIPOLAR COAGULATION FORCEPS



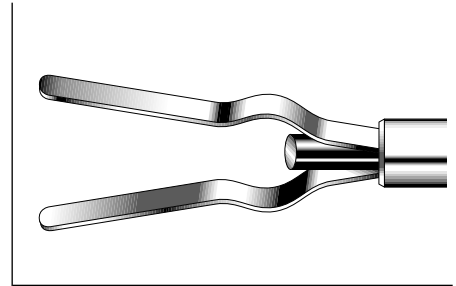
MICRO TIP BIPOLAR

31-5550 34 cm long With Spring Handle
5 mm Diameter



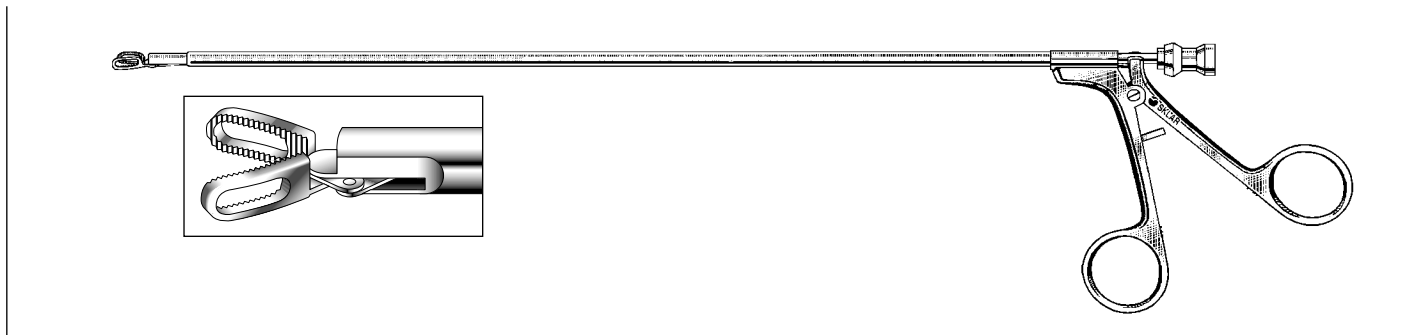
GRASPING TIP BIPOLAR

31-5552 34 cm long With Spring Handle
5 mm Diameter



LARGE TIP BIPOLAR

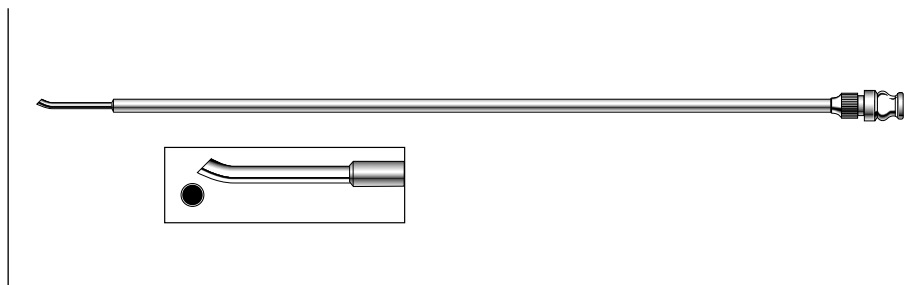
31-5554 34 cm long With Spring Handle
5 mm Diameter



TUBING FORCEPS NON-INSULATED

Non-Insulated

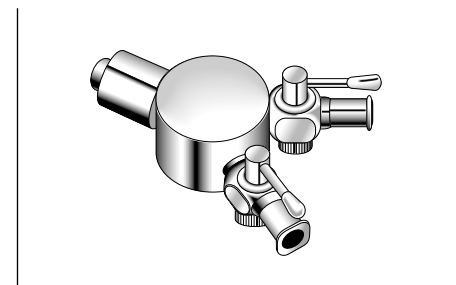
31-2255 For Colangiogram 33 cm



COLANGIOGRAM GUIDE

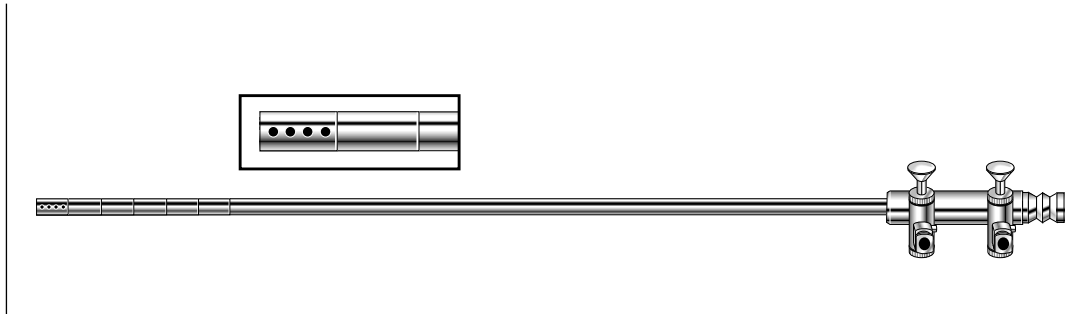
Non-Insulated

31-2260 Slightly Curved Tip, Standard Hub 33 cm x 5 mm



TWO WAY STOPCOCK

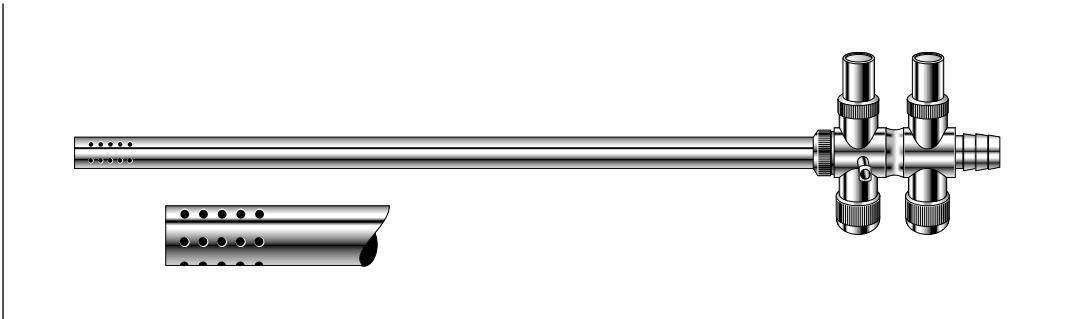
31-2264 Luer Lock Connections



IRRIGATION CANNULA

Non-Insulated

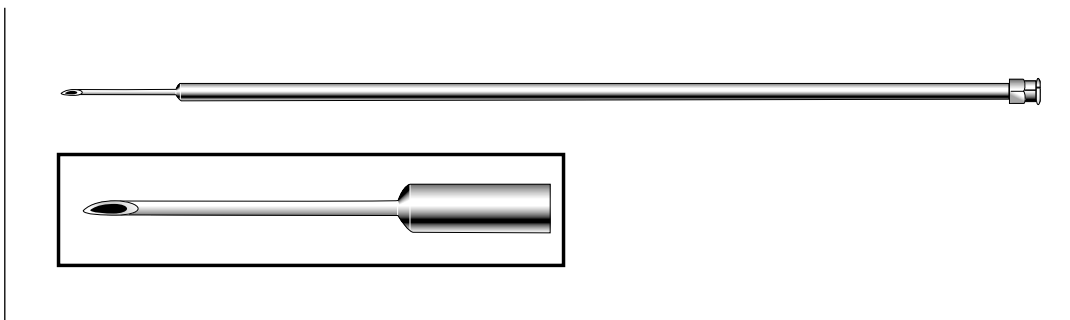
31-2210 Dual Channel, for Irrigation and Suction Graduated with Laser Guide



IRRIGATION/SUCTION CANNULA

Removable Tubes

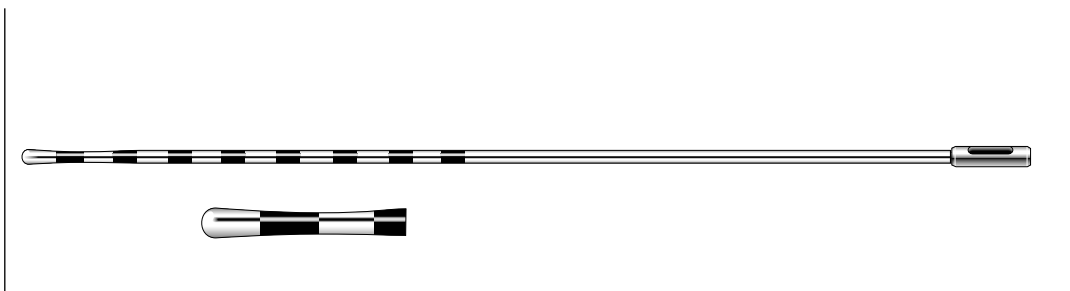
31-2212 33 cm Long Includes one 10 mm cannula and one 5 mm cannula



NEEDLE FOR INJECTION & IRRIGATION

With Luer Type Hub

31-2355 5 mm diameter 32 cm long



GRADUATED PROBE

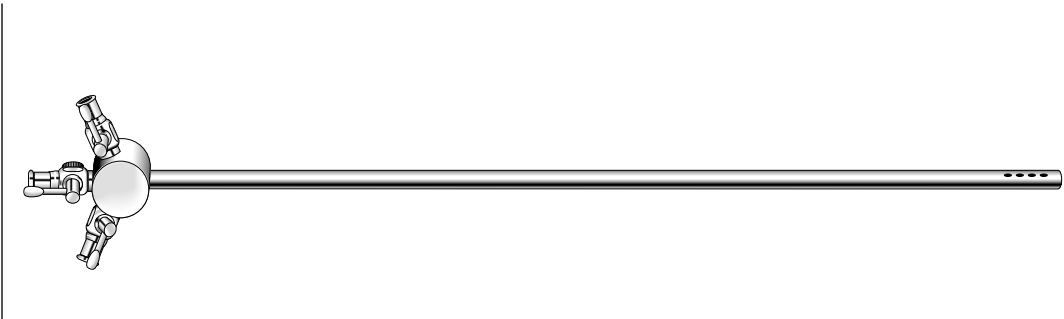
31-2365 For Palpation



VERESS NEEDLE

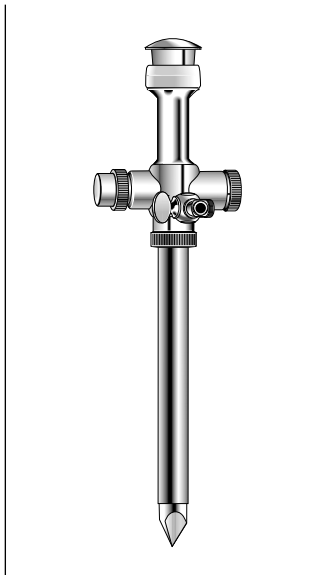
31-2350 With Stopcock 120 mm 2 mm Diameter

31-2352 With Stopcock 150 mm 2 mm Diameter



SUCTION/IRRIGATION TUBE

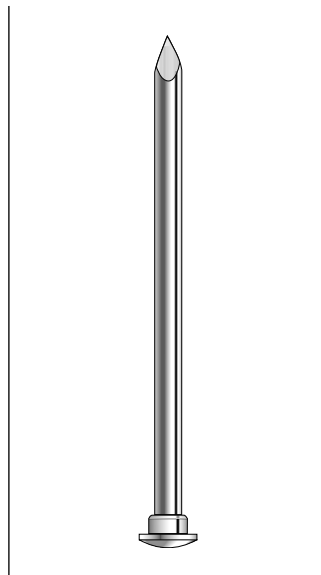
With Channel For Laser-Fiber
31-2205



TROCAR & CANNULA

Non-Insulated

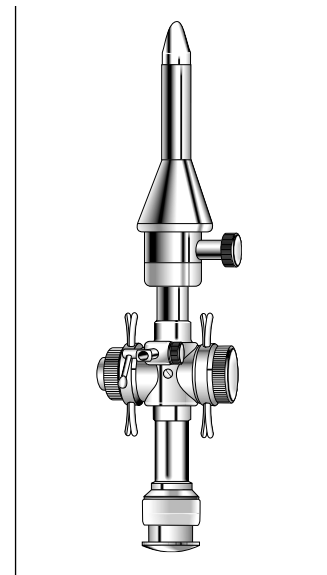
- 31-2320 Pyramidal Tip w/Piston Valve 5 mm
- 31-2325 Pyramidal Tip w/Piston Valve 10 mm
- 31-2328 Pyramidal Tip w/Piston Valve 11 mm
- 31-2329 Pyramidal Tip w/Piston Valve 12.5 mm



TROCAR

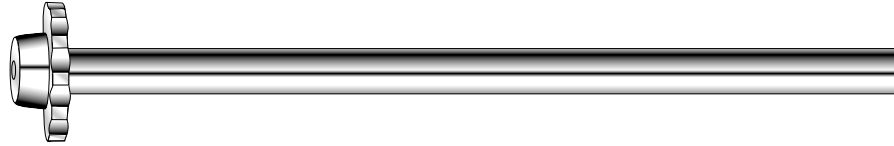
With Pyramidal Tip

- 31-2330 Trocar Only-Pyramidal Tip fits 31-2320 5 mm
- 31-2335 Trocar Only-Pyramidal Tip fits 31-2325 10 mm
- 31-2338 Trocar Only-Pyramidal Tip fits 31-2328 11 mm
- 31-2334 Trocar Only-Pyramidal Tip fits 31-2329 12.5 mm



HASSAN TROCAR

- 31-2310 11 mm with trumpet-valve Stopcock for insufflation and trocar mandrin with blunt tip



REDUCING SLEEVE

31-2348 To reduce 15 mm cannula to 11 mm
31-2340 To reduce 11 mm cannula to 6 mm

31-2345 To reduce 8 mm cannula to 6 mm



DILATION SET

31-2305 Dilate 6 mm cannula puncture to 11 mm



MYOMA DRILL

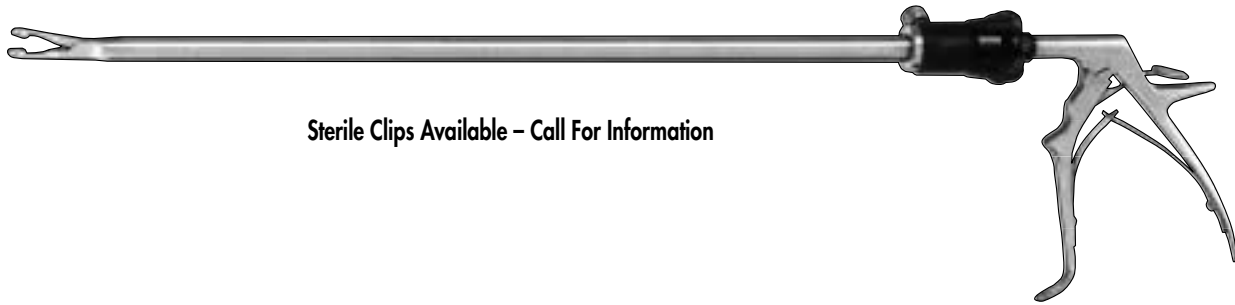
31-2360 45 cm Long 5 mm Diameter
31-2362 45 cm Long 10 mm Diameter



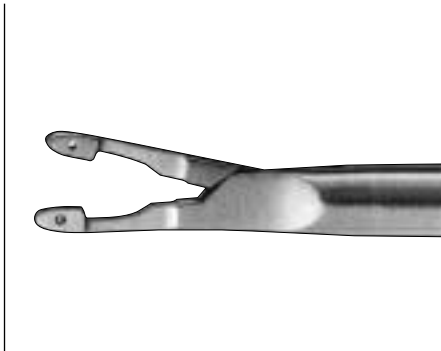
GALL STONE COLLECTOR

31-2364 With Suture Cutter and Luer-Lock Cleaning Port Length 33 cm

ENDOSCOPY CLIP APPLYING FORCEPS

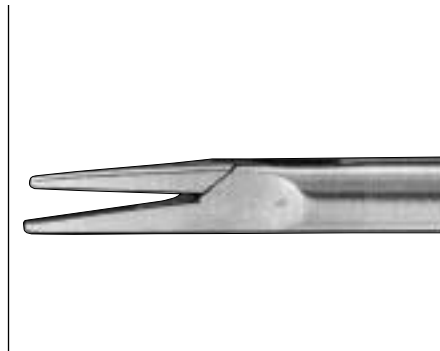


Sterile Clips Available – Call For Information



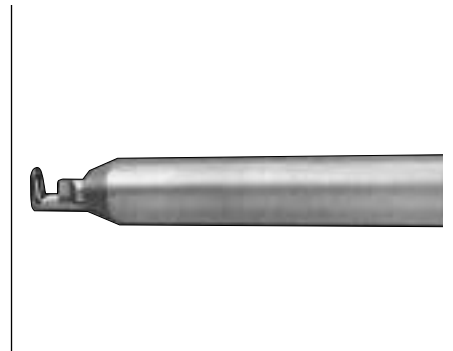
CLIP APPLYING FORCEPS

Non-Insulated
31-2250 Rotatable for 6 medium Clips
Nu-Grip Handle-Cannula
10 mm x 33 cm



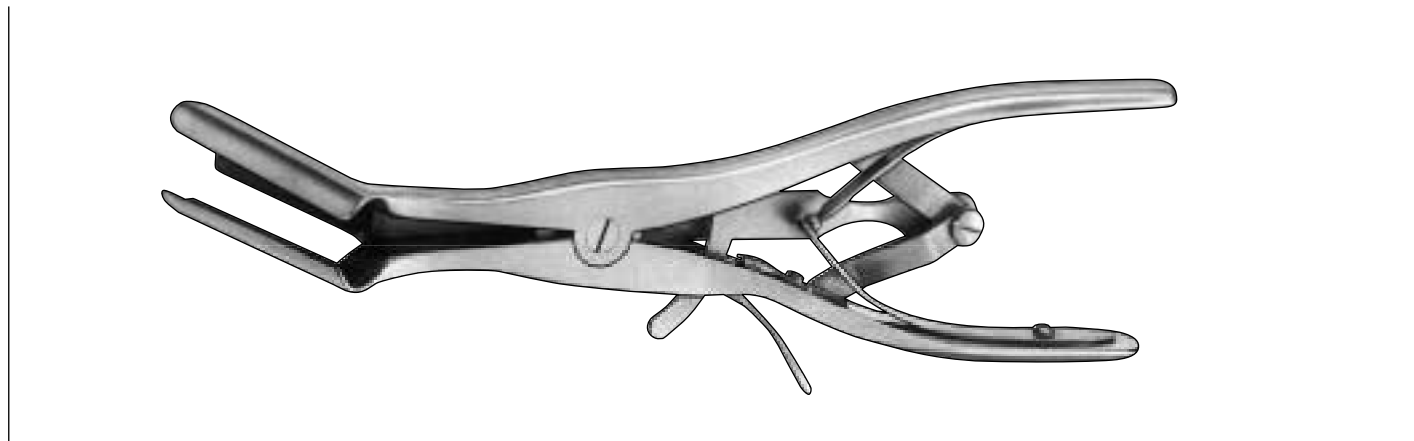
CLIP APPLYING FORCEPS

Non-Insulated
31-2248 Rotatable for medium Titanium Clips
Nu-Grip Handle-Cannula
10 mm x 33 cm



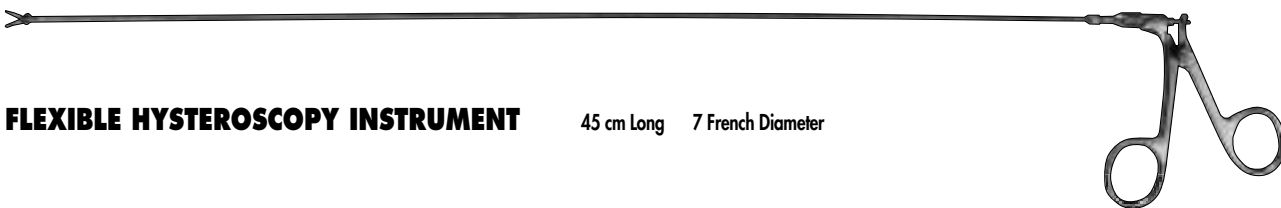
STABLER B-CLIP REMOVER

31-2246 Rotatable Handle
10 mm x 33 cm

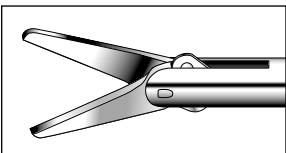


RETRACTOR FOR GALL BLADDER EXTRACTION

31-2240 Consisting of 3 parts

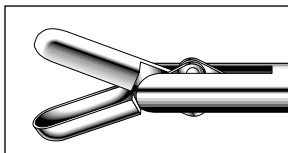


FLEXIBLE HYSTEROSCOPY INSTRUMENT 45 cm Long 7 French Diameter



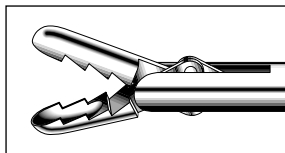
SCISSORS

Flexible
31-6050



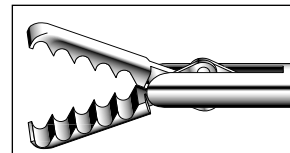
BIOPSY FORCEPS

Scoop, Flexible
31-6052



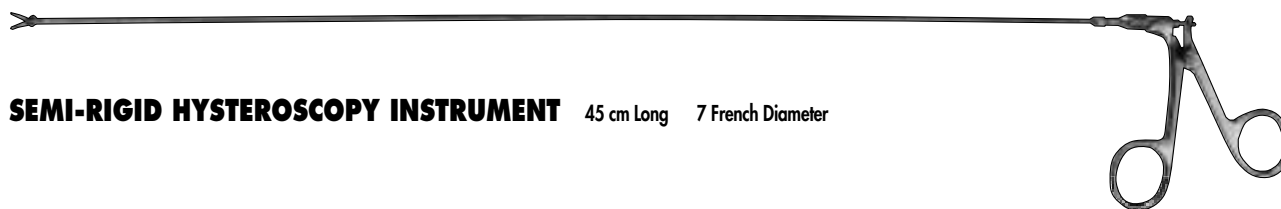
BIOPSY FORCEPS

Flexible, Serrated Jaws
31-6054

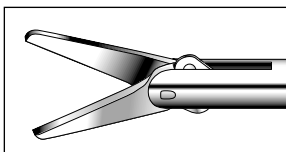


GRASPING FORCEPS

Flexible
31-6056

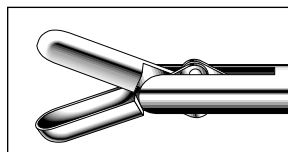


SEMI-RIGID HYSTEROSCOPY INSTRUMENT 45 cm Long 7 French Diameter



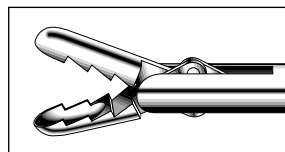
SCISSORS

Semi-Rigid
31-6058



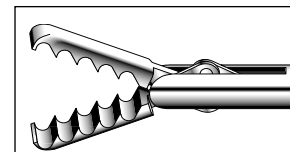
BIOPSY FORCEPS

Scoop Semi-Rigid
31-6060



BIOPSY FORCEPS

Semi-Rigid Serrated Jaws
31-6062

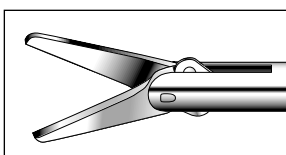


GRASPING FORCEPS

Semi-Rigid
31-6064

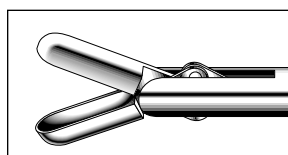


FLEXIBLE AND INSULATED HYSTEROSCOPY INSTRUMENT 45 cm Long 7 French Diameter



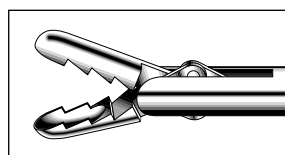
SCISSORS

Flexible & Insulated
31-6066



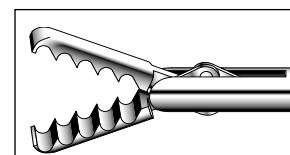
BIOPSY FORCEPS

Flexible & Insulated
31-6068 Scoop



BIOPSY FORCEPS

Flexible & Insulated Serr. Jaws
31-6070 Serrated Jaws



GRASPING FORCEPS

Flexible & Insulated
31-6072

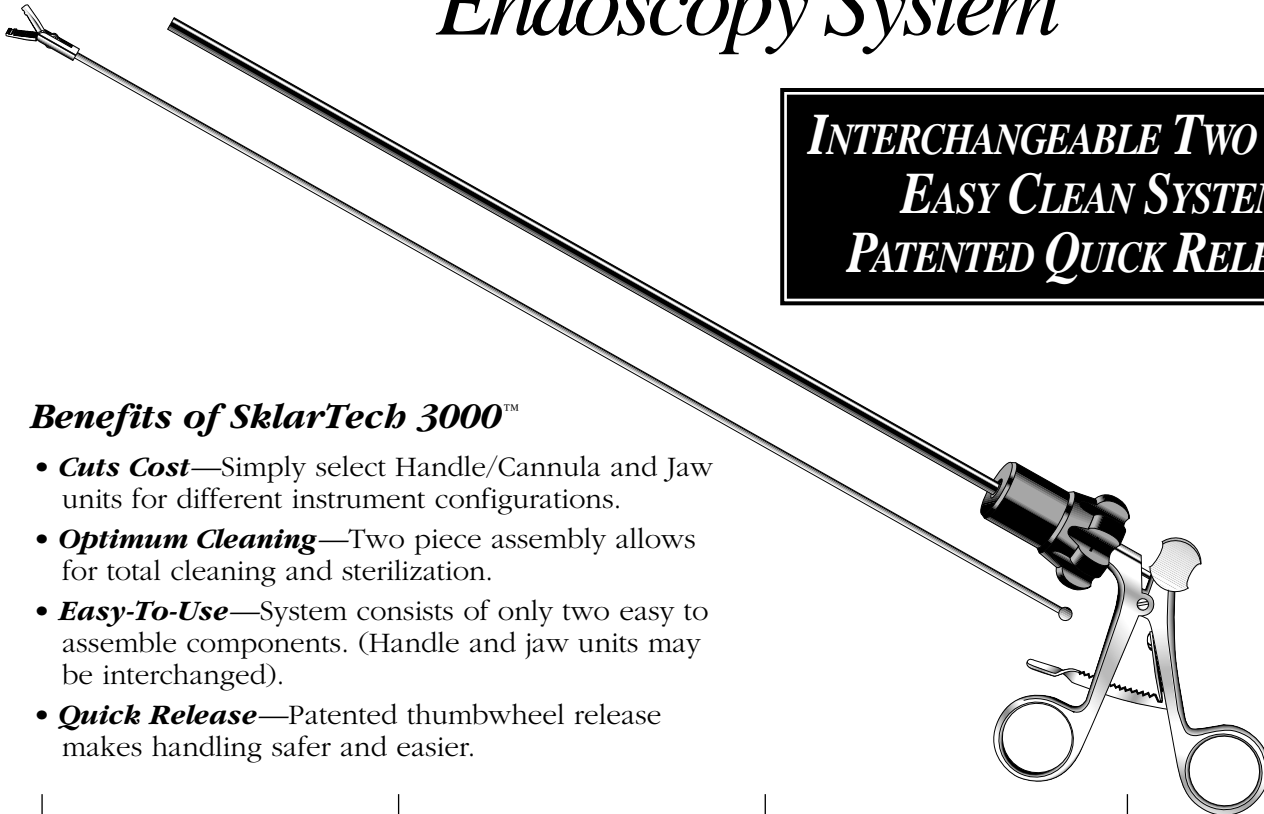


NEW!

SKLARTECH 3000™

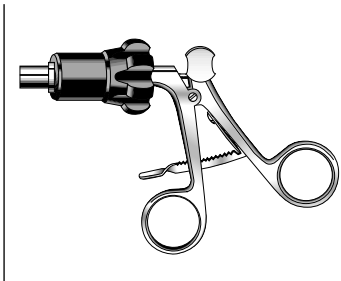
Endoscopy System

**INTERCHANGEABLE TWO PIECE
EASY CLEAN SYSTEM
PATENTED QUICK RELEASE**

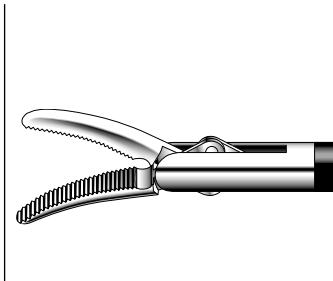


Benefits of SklarTech 3000™

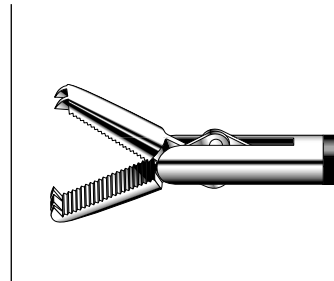
- **Cuts Cost**—Simply select Handle/Cannula and Jaw units for different instrument configurations.
- **Optimum Cleaning**—Two piece assembly allows for total cleaning and sterilization.
- **Easy-To-Use**—System consists of only two easy to assemble components. (Handle and jaw units may be interchanged).
- **Quick Release**—Patented thumbwheel release makes handling safer and easier.



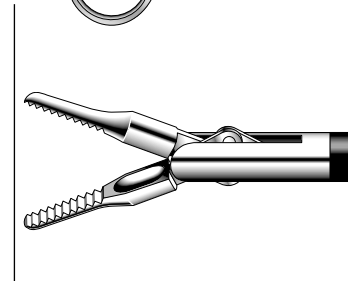
SKLARTECH 3000™ HANDLE
31-6150 Handle with cannula non-insulated
31-6152 Handle with cannula insulated



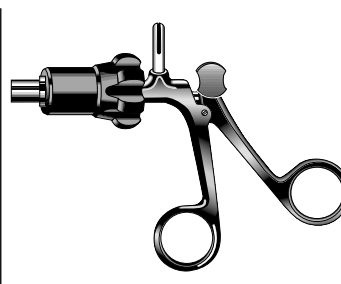
MARYLAND DISSECTOR
31-6160 Jaw with Stylet
33 cm long 5 mm diameter



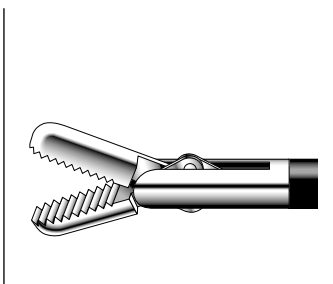
COBRA GRASPING FORCEPS
31-6162 Jaw with Stylet
Double Action 33 cm long
5 mm diameter



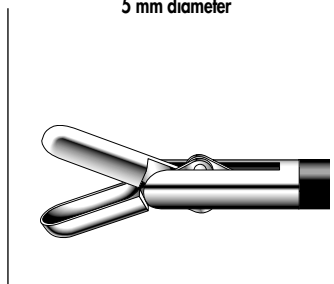
DOLPHIN DISSECTING AND GRASPING FORCEPS WITH SPOON
31-6164 Jaw with Stylet
33 cm long 5 mm diameter



SKLARTECH 3000™ HANDLE
31-6155 Handle with cannula insulated



DISSECTING AND GRASPING FORCEPS
31-6166 Jaw with Stylet Blunt
33 cm long 5 mm diameter



BIOPSY FORCEPS SPOON JAW
31-6168 Jaw with Stylet
33 cm long 5 mm diameter



FENESTRATED GRASPING FORCEPS
31-6170 Jaw with Stylet
33 cm long 5 mm diameter



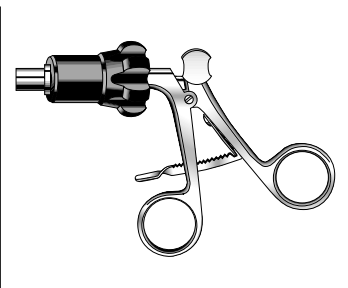
SKLARTECH 3000™

Endoscopy System

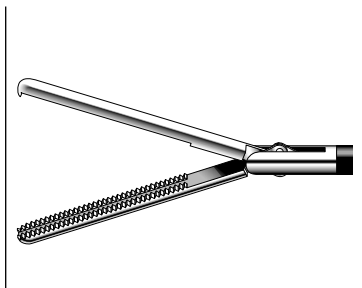
**INTERCHANGEABLE TWO PIECE
EASY CLEAN SYSTEM
PATENTED QUICK RELEASE**

Benefits of SklarTech 3000™

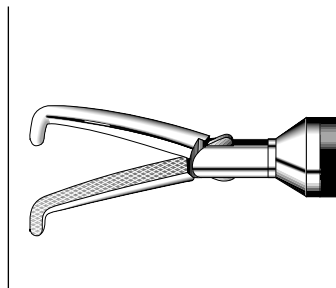
- **Cuts Cost**—Simply select Handle/Cannula and Jaw units for different instrument configurations.
- **Optimum Cleaning**—Two piece assembly allows for total cleaning and sterilization.
- **Easy-To-Use**—System consists of only two easy to assemble components. (Handle and jaw units may be interchanged).
- **Quick Release**—Patented thumbwheel release makes handling safer and easier.



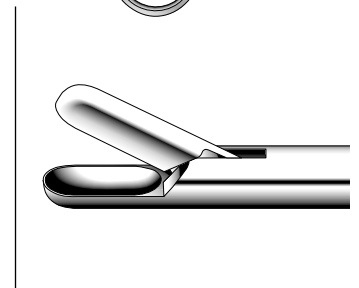
SKLARTECH 3000™ HANDLE
31-6150 Handle with cannula non-insulated
31-6152 Handle with cannula insulated



DEBAKEY ATRAUMATIC INTESTINAL FORCEPS
31-6172 20 mm Jaw with Stylet
31-6174 40 mm Jaw with Stylet
5 mm diameter Jaw 30 mm long



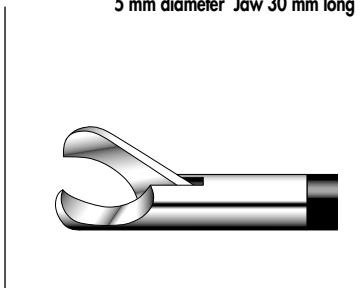
MIXER DISSECTOR
31-6176 Jaw with Stylet
Right-Angled
33 cm long 10 mm diameter



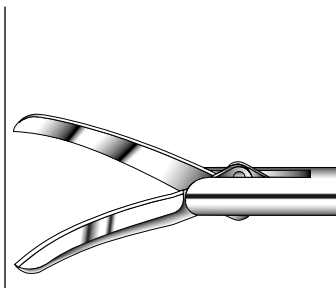
OPERATING SPOON WITH RETAINING SPOON
31-6178 Jaw with Stylet
33 cm long 10 mm diameter



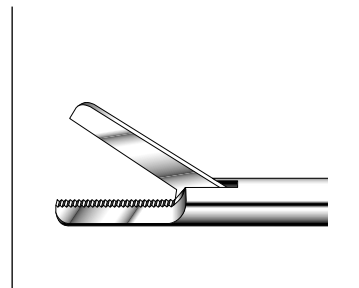
SKLARTECH 3000™ HANDLE
31-6155 Handle with cannula insulated



HOOK SCISSORS
31-6180 Jaw with Stylet
33 cm long 5 mm diameter



METZENBAUM SCISSORS
31-6182 Double Action Curved
33 cm long 5 mm diameter



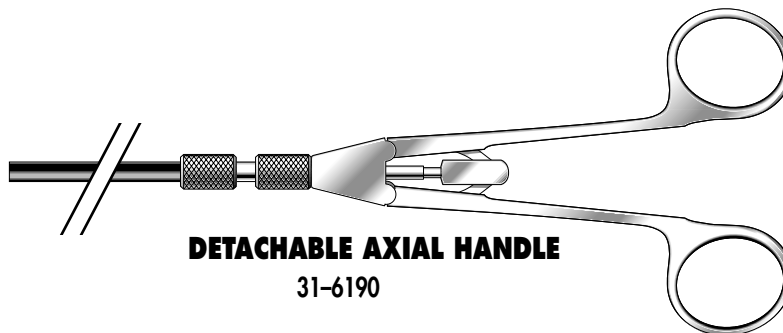
PERITONEAL SCISSORS
31-6184 Serrated Jaws Blunt
Straight
33 cm long 5 mm diameter

Jaws are Interchangeable with all SklarTech 3000™ Handles.



NEW!

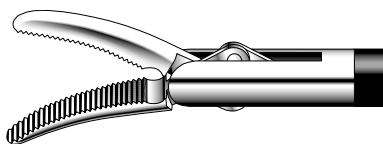
SKLARTECH 3000™



DETACHABLE AXIAL HANDLE
31-6190

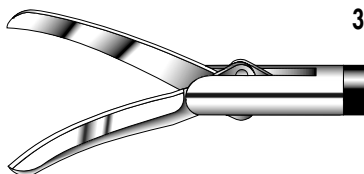
MARYLAND DISSECTOR

31-6192 33 cm long
5 mm Diameter



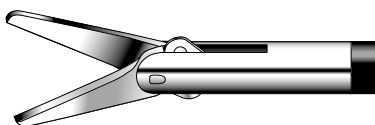
METZENBAUM SCISSORS

31-6196 Double Action Jaws
Curved
33 cm long
5 mm Diameter



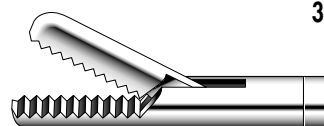
METZENBAUM SCISSORS

31-6194 Double Action
Straight
33 cm long
5 mm Diameter

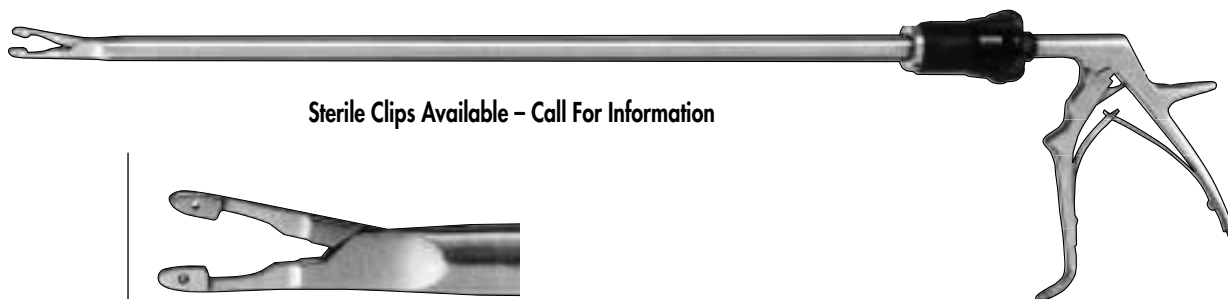


TUNGSTEN CARBIDE NEEDLE HOLDER

31-6198 33 cm long
5 mm Diameter
One Piece Non-Detachable
with Ratchet



Sterile Clips Available – Call For Information



CLIP APPLYING FORCEPS COMPLETE UNIT

Non-Insulated
31-6200 For Use With Ethicon™ Clips
ST-300 and TI-300

Parts:	
31-6210	Jaw/Stylet
31-6212	Cannula/Shaft
31-6214	Handle



DOUBLE EDGE BANANA KNIFE

45-6050 With Knurled Handle



BANANA KNIFE SERRATED

45-6052 With Knurled Handle



HOOK KNIFE 90°

45-6054 With Knurled Handle



ROSETTE KNIFE STRAIGHT SERRATED

45-6056 With Knurled Handle



MENISCUTOME

45-6058 With Knurled Handle



SMILIE KNIFE

45-6060 With Knurled Handle
5 mm



RETROGRADE KNIFE 45°

45-6062 With Knurled Handle



TRADITIONAL KNIFE

45-6064 With Knurled Handle



RING CURETTE

45-6066 With Knurled Handle
3 mm



SPOON 30° CURVED

45-6068 With Knurled Handle
3 mm



HOOK GRADUATED PROBE

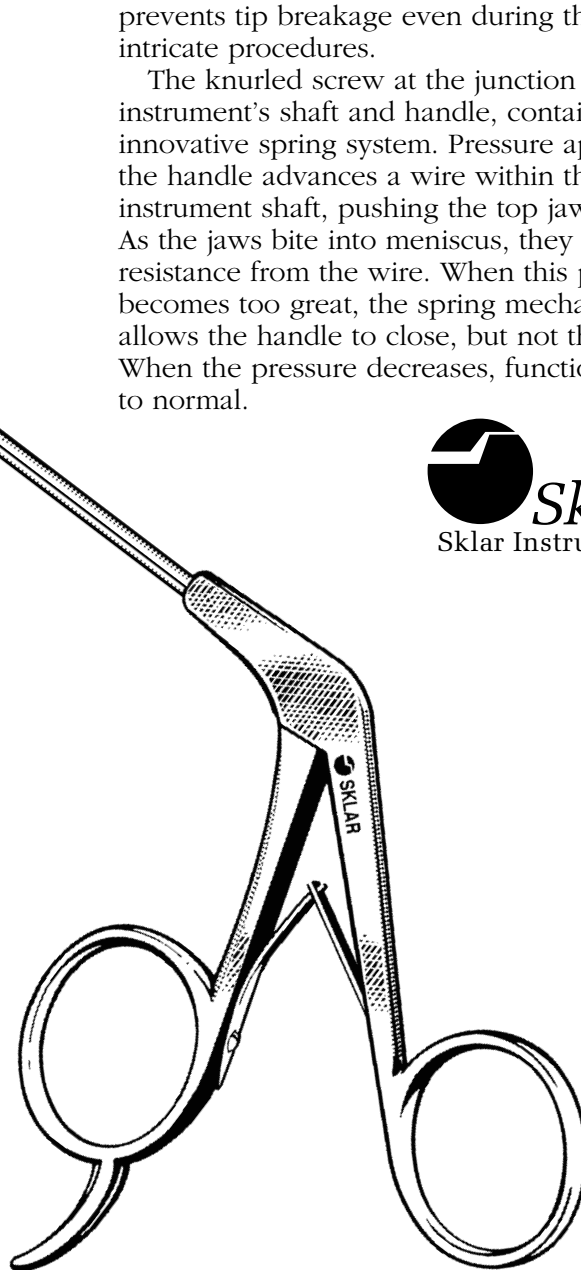
45-6070 With Knurled Handle



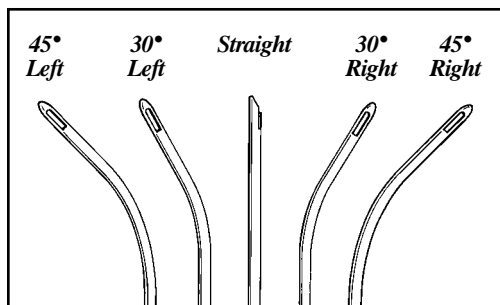
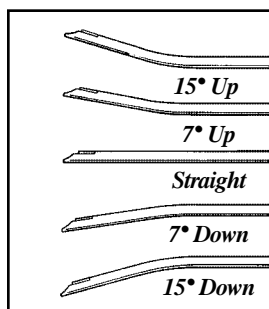
New Sklar Arthroscopy Instruments

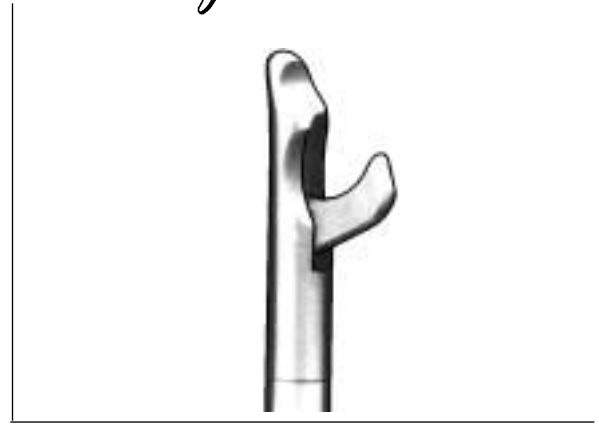
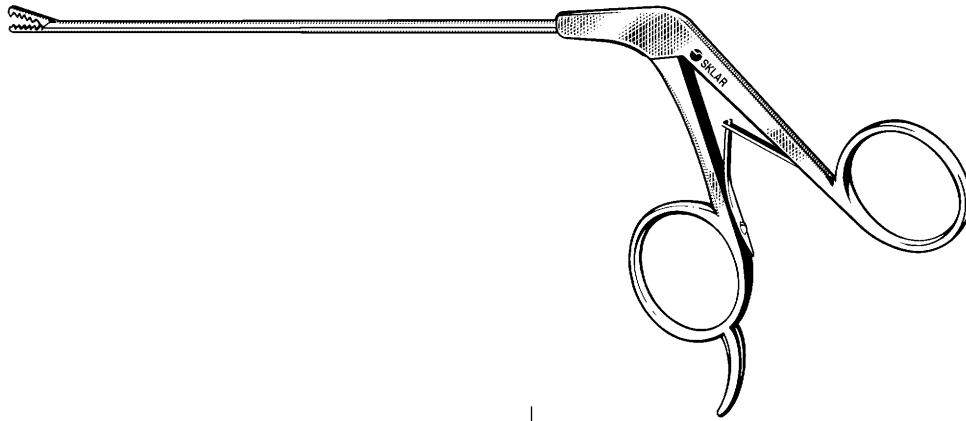
Sklar is proud to present its new line of arthroscopy instruments, featuring dual safety pins and an innovative spring system that prevents tip breakage even during the most intricate procedures.

The knurled screw at the junction of the instrument's shaft and handle, contains the innovative spring system. Pressure applied to the handle advances a wire within the instrument shaft, pushing the top jaw down. As the jaws bite into meniscus, they meet resistance from the wire. When this pressure becomes too great, the spring mechanism allows the handle to close, but not the jaws. When the pressure decreases, function returns to normal.



Available Angles—





SCISSORS

45-6080	2.75 mm	Straight Hook	45-6086	3.4 mm	Straight Hook
45-6082	2.75 mm	30° Right Hook	45-6088	3.4 mm	30° Right Hook
45-6084	2.75 mm	30° Left Hook	45-6089	3.4 mm	30° Left Hook

BASKET FORCEPS SIDE BITER

45-6090	3.4 mm	90° Right Scoop	45-6098	3.4 mm	90° Right Blunt
45-6092	3.4 mm	90° Left Scoop	45-6100	3.4 mm	90° Left Blunt
45-6094	3.4 mm	45° Right Scoop	45-6102	3.4 mm	45° Right Blunt
45-6096	3.4 mm	45° Left Scoop	45-6104	3.4 mm	45° Left Blunt



BASKET FORCEPS SCOOP NOSE

45-6112	2.75 mm	Straight	45-6140	3.4 mm	Straight
45-6114	2.75 mm	45° Right	45-6142	3.4 mm	45° Right
45-6116	2.75 mm	45° Left	45-6144	3.4 mm	45° Left
45-6118	2.75 mm	30° Right	45-6146	3.4 mm	30° Right
45-6120	2.75 mm	30° Left	45-6148	3.4 mm	30° Left
45-6122	2.75 mm	7° Upward	45-6150	3.4 mm	7° Upward
45-6124	2.75 mm	7° Downward	45-6152	3.4 mm	7° Downward
45-6126	2.75 mm	15° Upward	45-6154	3.4 mm	15° Upward
45-6128	2.75 mm	15° Downward	45-6156	3.4 mm	15° Downward

BASKET FORCEPS SCOOP NOSE

45-6140	3.4 mm	Straight	45-6140	3.4 mm	Straight
45-6142	3.4 mm	45° Right	45-6142	3.4 mm	45° Right
45-6144	3.4 mm	45° Left	45-6144	3.4 mm	45° Left
45-6146	3.4 mm	30° Right	45-6146	3.4 mm	30° Right
45-6148	3.4 mm	30° Left	45-6148	3.4 mm	30° Left
45-6150	3.4 mm	7° Upward	45-6150	3.4 mm	7° Upward
45-6152	3.4 mm	7° Downward	45-6152	3.4 mm	7° Downward
45-6154	3.4 mm	15° Upward	45-6154	3.4 mm	15° Upward
45-6156	3.4 mm	15° Downward	45-6156	3.4 mm	15° Downward

BASKET FORCEPS BLUNT NOSE

45-6210	2.75 mm	Straight	45-6240	3.4 mm	Straight
45-6212	2.75 mm	45° Right	45-6242	3.4 mm	45° Right
45-6214	2.75 mm	45° Left	45-6244	3.4 mm	45° Left
45-6216	2.75 mm	30° Right	45-6246	3.4 mm	30° Right
45-6218	2.75 mm	30° Left	45-6248	3.4 mm	30° Left
45-6220	2.75 mm	7° Upward	45-6250	3.4 mm	7° Upward
45-6222	2.75 mm	7° Downward	45-6252	3.4 mm	7° Downward
45-6224	2.75 mm	15° Upward	45-6254	3.4 mm	15° Upward
45-6226	2.75 mm	15° Downward	45-6256	3.4 mm	15° Downward

BASKET FORCEPS BLUNT NOSE

45-6240	3.4 mm	Straight	45-6240	3.4 mm	Straight
45-6242	3.4 mm	45° Right	45-6242	3.4 mm	45° Right
45-6244	3.4 mm	45° Left	45-6244	3.4 mm	45° Left
45-6246	3.4 mm	30° Right	45-6246	3.4 mm	30° Right
45-6248	3.4 mm	30° Left	45-6248	3.4 mm	30° Left
45-6250	3.4 mm	7° Upward	45-6250	3.4 mm	7° Upward
45-6252	3.4 mm	7° Downward	45-6252	3.4 mm	7° Downward
45-6254	3.4 mm	15° Upward	45-6254	3.4 mm	15° Upward
45-6256	3.4 mm	15° Downward	45-6256	3.4 mm	15° Downward

*Sklar Meets The
Needs Of The Most
Demanding
Surgeon With The
Introduction Of
Sklarlite™ And
Sklarlite™ XD*

In the continuing tradition of offering the most advanced instrument design, Sklar is proud to introduce Sklarlite™ and Sklarlite XD™. This all new line of lighter instrument patterns offers the surgeon *greater control with less fatigue during operations.*

Sklar's R & D department has recognized the need for a manufacturing process that carefully shaves microns off the standard and delicate patterns without sacrificing

strength and flexibility. The result is Sklarlite™ for regular pattern and Sklarlite XD™ for an extra delicate pattern. The two designs are noticeably lighter, extremely sensitive and offer the surgeon *maximum control* and precision. The result is a new line of instruments designed for today's demanding surgery.

Sklarlite™ and Sklarlite XD™ carry the same day-in and day-out reliability that you have come to expect from all Sklar instruments. Sklar has applied its more than 100 years of experience in developing this superior line of instruments. Of course Sklarlite™ and Sklarlite XD™ instruments are covered under the same warranty that guarantees all Sklar instruments for a lifetime of dependable service.

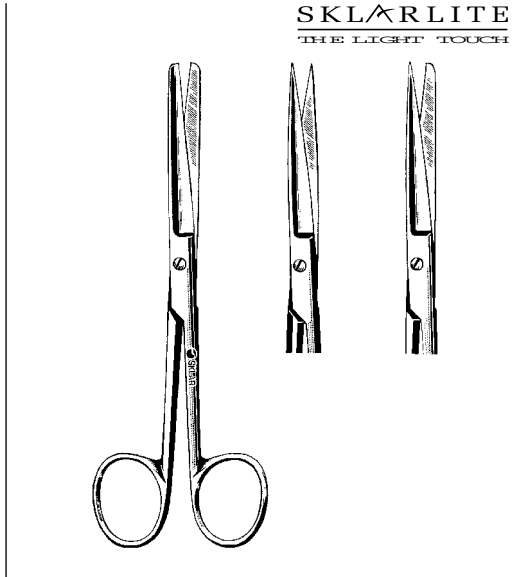
Sklarlite™ and Sklarlite XD™ are two new reasons why Sklar is leading the way in superior quality surgical instrument development.



The Tradition Continues

NEW!

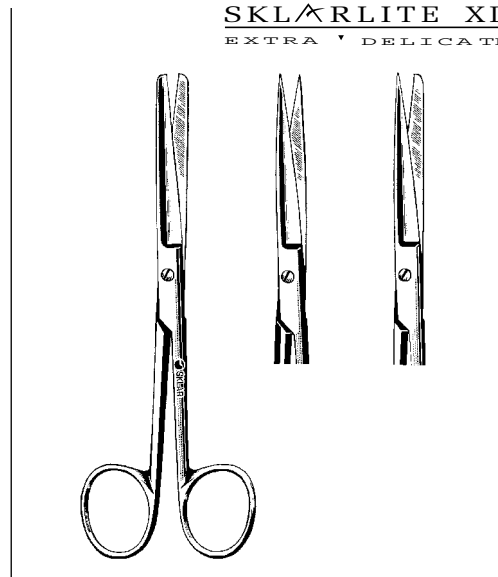
SKLARLITE INSTRUMENTS



SKLARLITE OPERATING SCISSORS

Straight

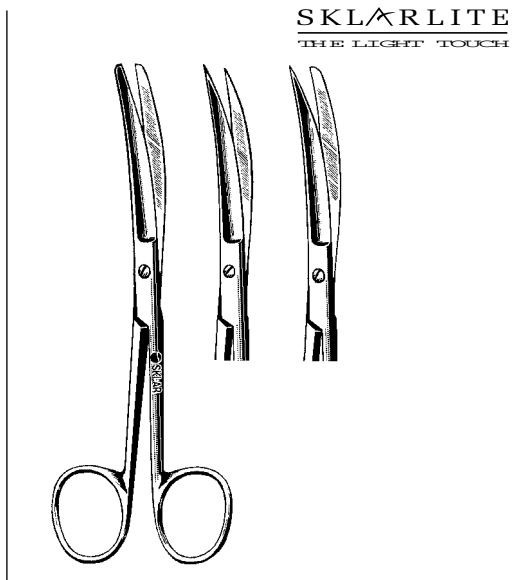
S/S		S/B	
23-1100	4½"	23-1104	4½"
23-1101	5"	23-1105	5"
23-1102	5½"	23-1106	5½"



SKLARLITE EXTRA DELICATE OPERATING SCISSORS

Straight

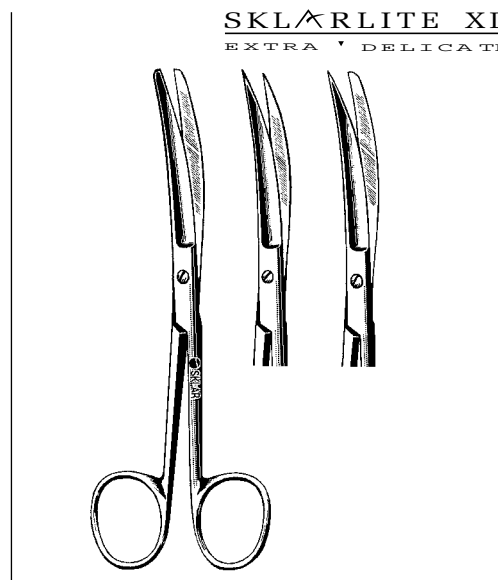
S/S		S/B	
23-1112	4½"	23-1116	4½"
23-1113	5"		
23-1114	5½"	23-1118	5½"



SKLARLITE OPERATING SCISSORS

Curved

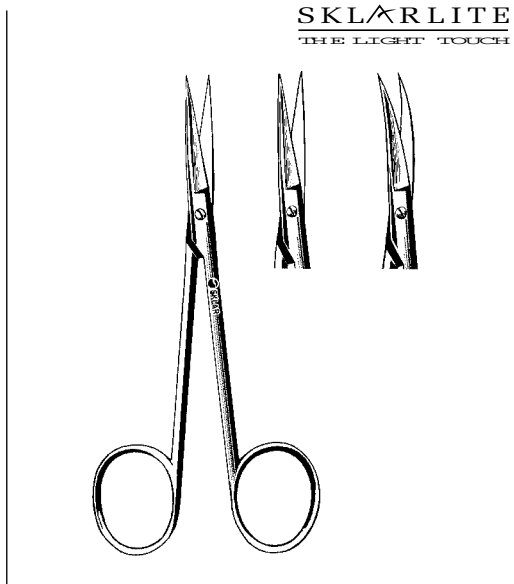
S/S		S/B	
23-1124	4½"		
23-1126	5½"	23-1130	5½"



SKLARLITE EXTRA DELICATE OPERATING SCISSORS

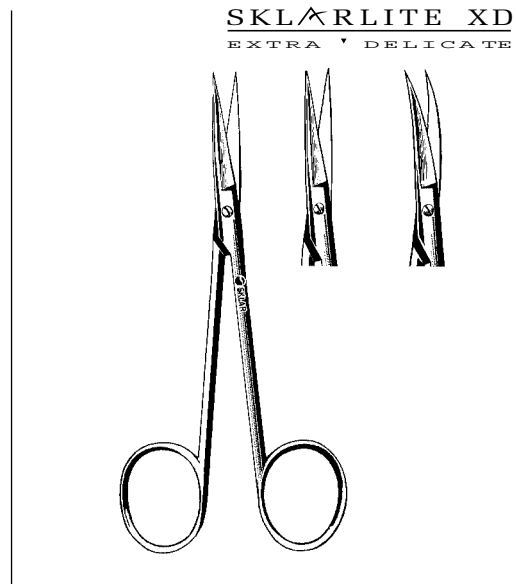
Curved

S/S		S/B	
		23-1140	4½"
23-1138	5½"	23-1142	5½"



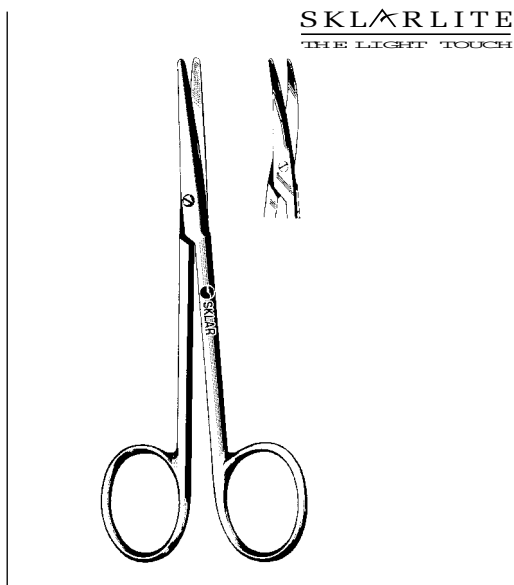
SKLARLITE IRIS SCISSORS

Straight		Curved	
23-1148	3½"	23-1150	3½"
23-1149	4½"	23-1151	4½"



SKLARLITE EXTRA DELICATE IRIS SCISSORS

Straight		Curved	
23-1152	3½"	23-1154	3½"
23-1153	4½"	23-1155	4½"



SKLARLITE STRABISMUS SCISSORS

Straight		Curved	
23-1158	4¼"	23-1159	4¼"



SKLARLITE EXTRA DELICATE STRABISMUS SCISSORS

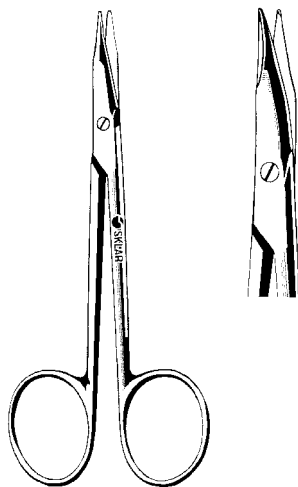
Straight		Curved	
23-1162	4¼"	23-1163	4¼"

NEW!

SKLARLITE INSTRUMENTS



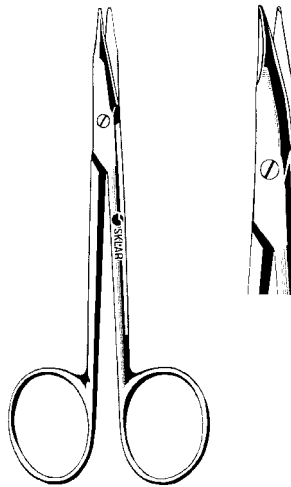
SKLARLITE
THE LIGHT TOUCH



SKLARLITE STEVENS TENOTOMY SCISSORS

Straight	Curved
23-1156 4½"	23-1157 4½"

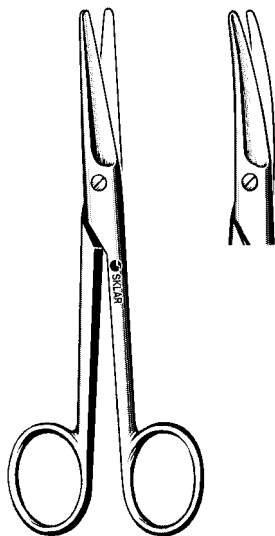
SKLARLITE XD
EXTRA DELICATE



SKLARLITE EXTRA DELICATE STEVENS TENOTOMY SCISSORS

Straight	Curved
23-1160 4½"	23-1161 4½"

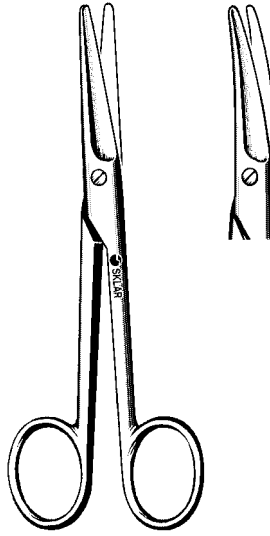
SKLARLITE
THE LIGHT TOUCH



SKLARLITE MAYO DISSECTING SCISSORS

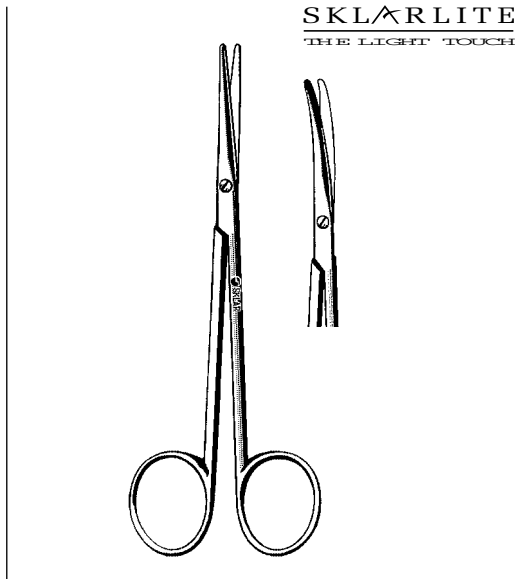
Straight	Curved
23-1164 5½"	23-1166 5½"
23-1165 6¾"	23-1167 6¾"

SKLARLITE XD
EXTRA DELICATE



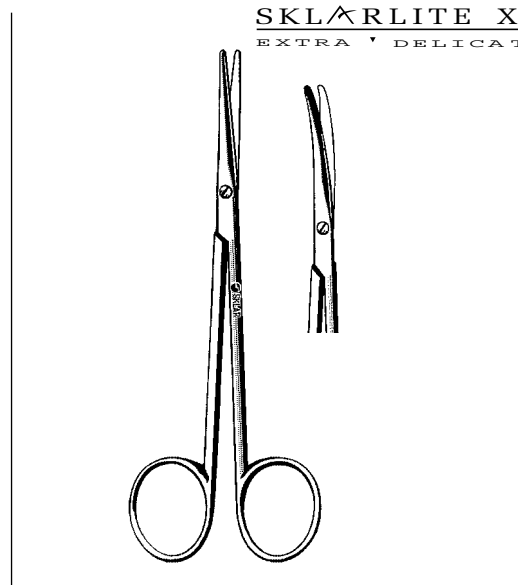
SKLARLITE EXTRA DELICATE MAYO DISSECTING SCISSORS

Straight	Curved
23-1168 5½"	23-1170 5½"
23-1169 6¾"	23-1171 6¾"



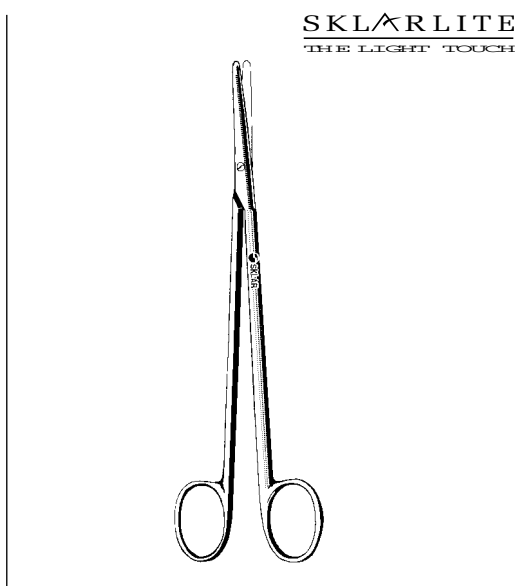
SKLARLITE METZENBAUM (LAHEY) SCISSORS

Straight		Curved	
23-1172	5"	23-1174	5"
23-1173	6"	23-1175	6"



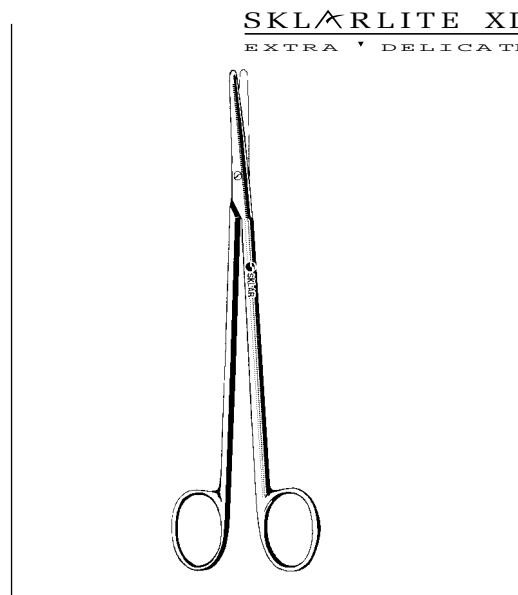
SKLARLITE EXTRA DELICATE METZENBAUM (LAHEY) SCISSORS

Straight		Curved	
23-1176	5"	23-1178	5"
23-1177	6"	23-1179	6"



SKLARLITE METZENBAUM DISSECTING SCISSORS

Straight		Curved	
23-1180	7"	23-1182	7"



SKLARLITE EXTRA DELICATE METZENBAUM DISSECTING SCISSORS

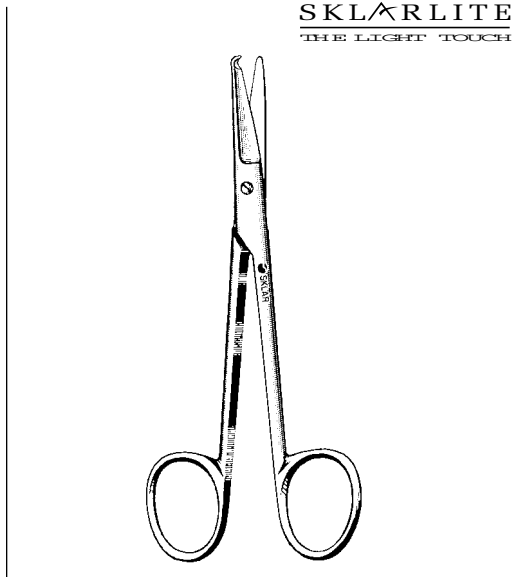
Straight		Curved	
23-1184	7"	23-1186	7"

NEW!

SKLARLITE INSTRUMENTS



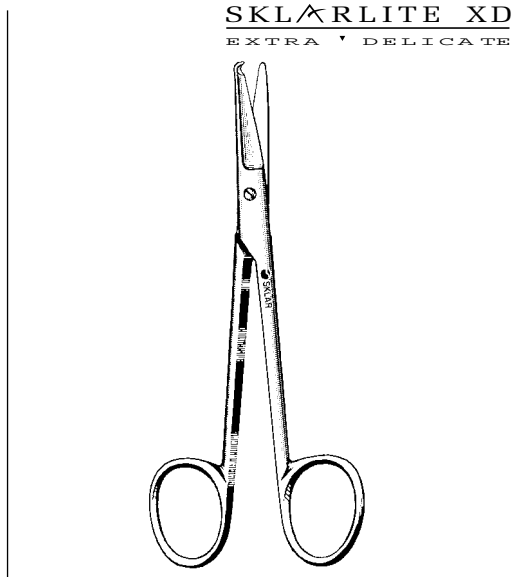
SKLARLITE
THE LIGHT TOUCH



SKLARLITE SPENCER STITCH SCISSORS

23-1188 3½"
23-1189 4½"
23-1190 5½" Littauer

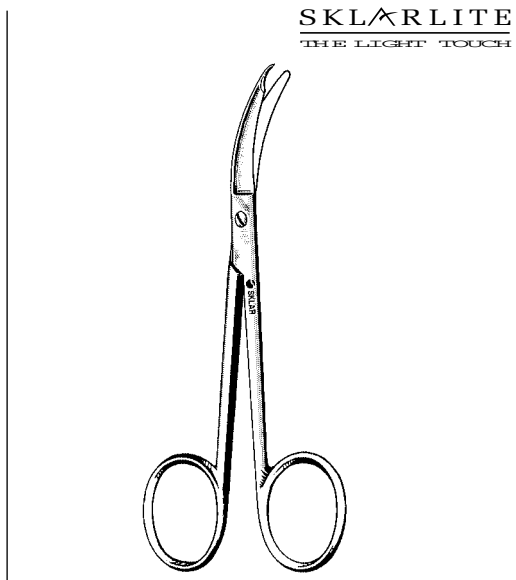
SKLARLITE XD
EXTRA DELICATE



SKLARLITE EXTRA DELICATE SPENCER STITCH SCISSORS

23-1193 3½"
23-1194 4½"
23-1195 5½" Littauer

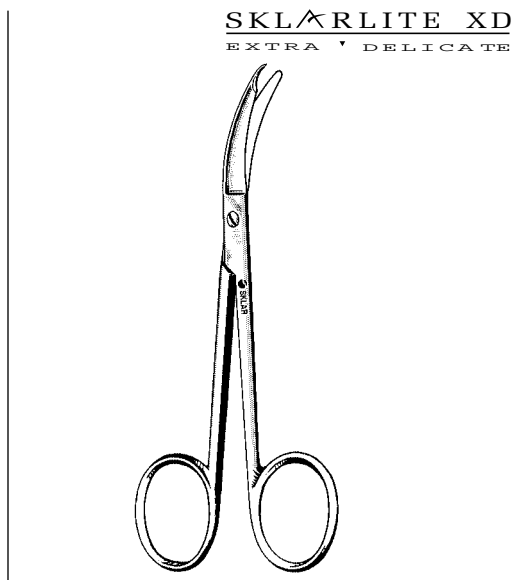
SKLARLITE
THE LIGHT TOUCH



SKLARLITE SUTURE SCISSORS

23-1191 3½" Shortbent

SKLARLITE XD
EXTRA DELICATE



SKLARLITE EXTRA DELICATE SUTURE SCISSORS

23-1196 3½" Shortbent

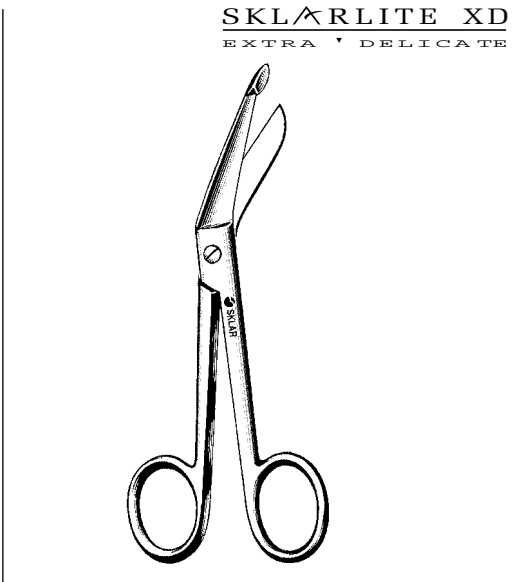
SKLARLITE
THE LIGHT TOUCH



**SKLARLITE
LISTER BANDAGE SCISSORS**

23-1199 5 1/2"
23-1200 7 1/4"

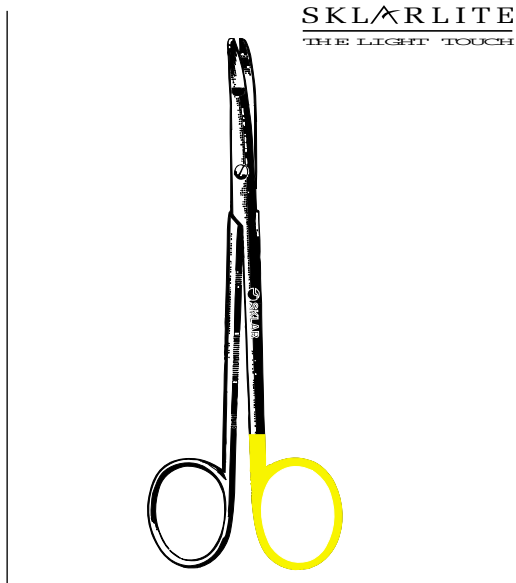
SKLARLITE XD
EXTRA DELICATE



**SKLARLITE EXTRA DELICATE
LISTER BANDAGE SCISSORS**

23-1202 5 1/2"
23-1203 7 1/4"

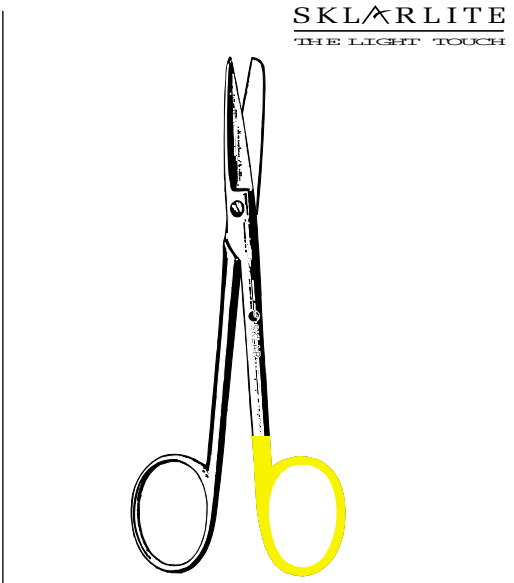
SKLARLITE
THE LIGHT TOUCH



**SKLARLITE SKLARCUT
RAGNELL DISSECTING
SCISSORS**

Curved
23-1250 5"

SKLARLITE
THE LIGHT TOUCH



**SKLARLITE SKLARCUT
WAGNER SCISSORS**

Straight
23-1254 4 3/4" S/B

NEW!

SKLARLITE INSTRUMENTS



SKLARLITE
THE LIGHT TOUCH



SKLARLITE SKLARCUT OPERATING SCISSORS

Straight

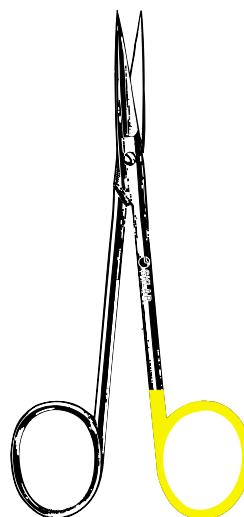
23-1260 5½" S/S

23-1262 5½" S/B

Curved

23-1266 5½" S/B

SKLARLITE
THE LIGHT TOUCH



SKLARLITE SKLARCUT IRIS SCISSORS

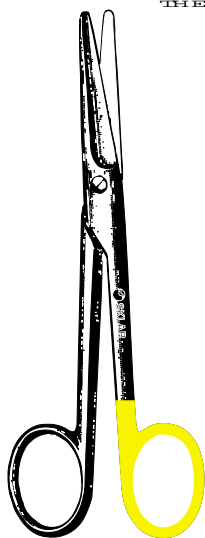
Straight

23-1268 4½"

Curved

23-1270 4½"

SKLARLITE
THE LIGHT TOUCH



SKLARLITE SKLARCUT MAYO DISSECTING SCISSORS

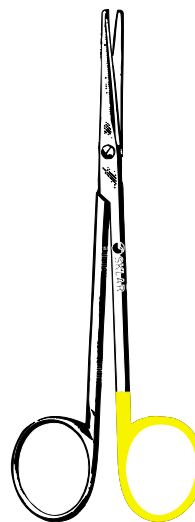
Straight

23-1274 6¾"

Curved

23-1278 6¾"

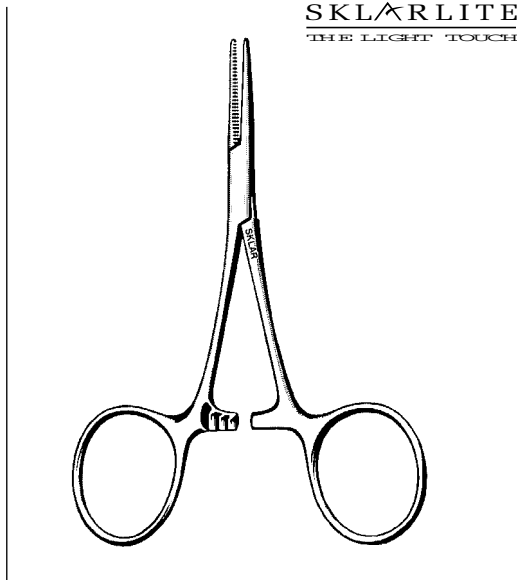
SKLARLITE
THE LIGHT TOUCH



SKLARLITE SKLARCUT METZENBAUM (LAHEY) SCISSORS

Curved-Blunt

23-1280 5¾"



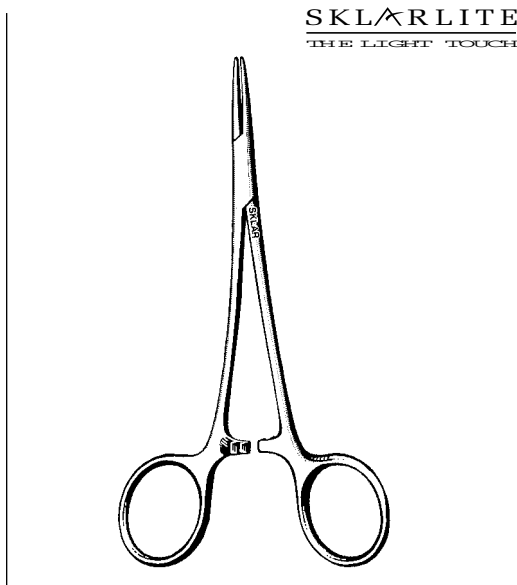
**SKLARLITE
HARTMANN MOSQUITO HEMOSTATS**

Straight	Curved
23-2100 3½"	23-2101 3½"



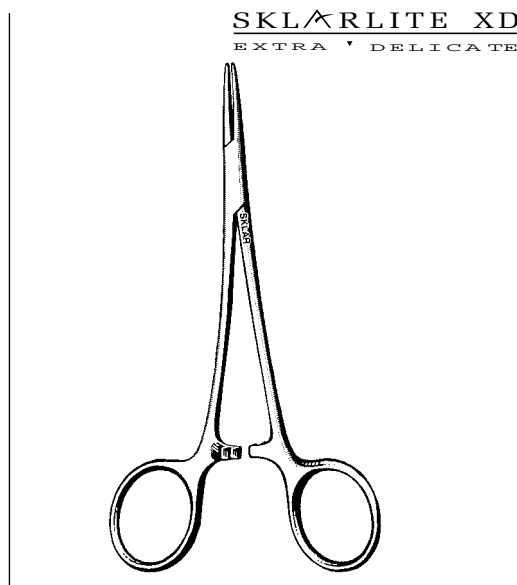
**SKLARLITE EXTRA DELICATE
HARTMANN MOSQUITO HEMOSTATS**

Straight	Curved
23-2500 3½"	23-2501 3½"



**SKLARLITE
HALSTED MOSQUITO HEMOSTATS**

Straight	Curved
23-2105 5"	23-2106 5"

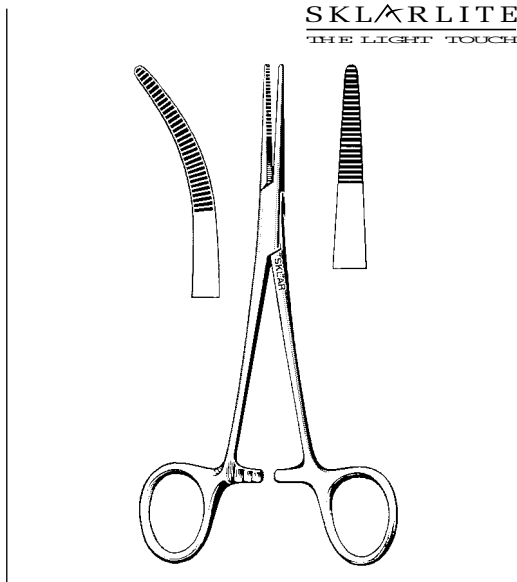


**SKLARLITE EXTRA DELICATE
HALSTED MOSQUITO HEMOSTATS**

Straight	Curved
23-2505 5"	23-2506 5"

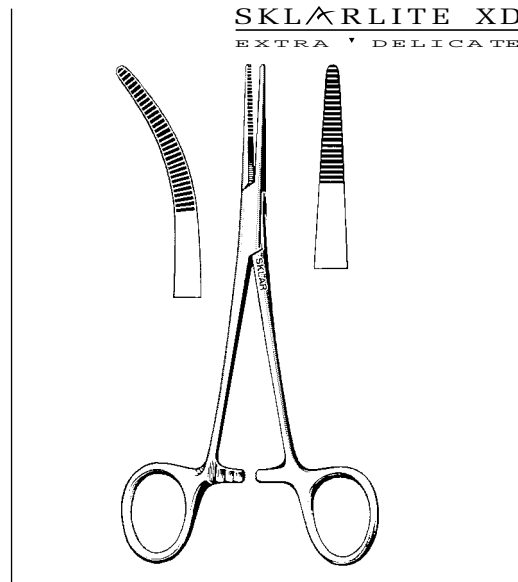
NEW!

SKLARLITE INSTRUMENTS



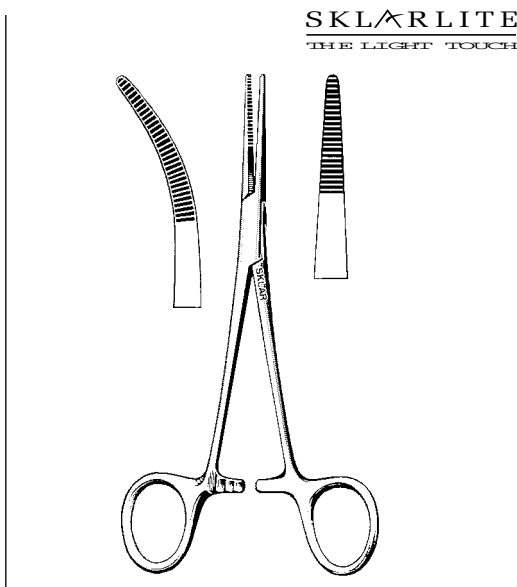
SKLARLITE KELLY HEMOSTATIC FORCEPS

Straight	Curved
23-2107 5½"	23-2108 5½"



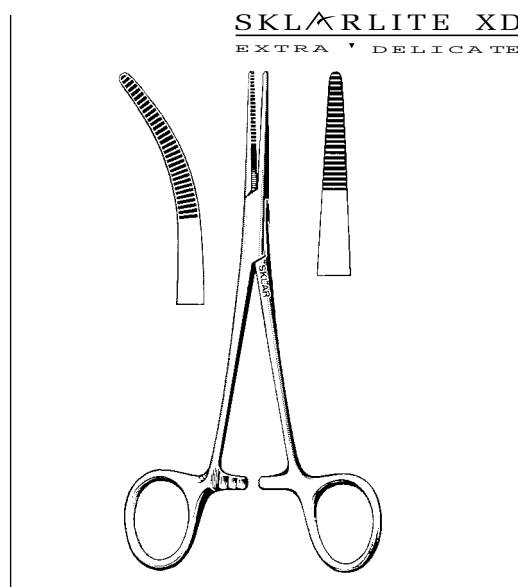
SKLARLITE EXTRA DELICATE KELLY HEMOSTATIC FORCEPS

Straight	Curved
23-2507 5½"	23-2508 5½"



SKLARLITE CRILE HEMOSTATIC FORCEPS

Straight	Curved
23-2110 5½"	23-2113 5½"



SKLARLITE EXTRA DELICATE CRILE HEMOSTATIC FORCEPS

Straight	Curved
23-2510 5½"	23-2513 5½"

Skarlite™ Forceps Provide Lightness And Durability

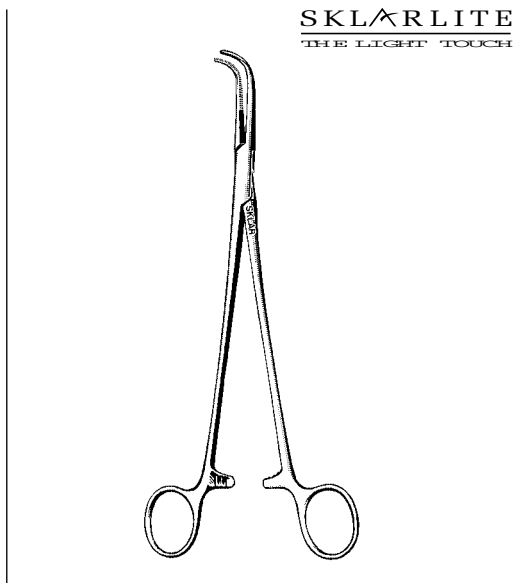
SKLARLITE THE LIGHT TOUCH

Sklar has developed a new line of premium operating room forceps that offers the surgeon maximum control and precision. Our research determined a need for forceps that was a lighter pattern while maintaining the strength and durability of a standard pattern.

Sklar has recognized the need for a manufacturing technique that mills scant microns off our standard pattern while maintaining the structural integrity of the original instrument. The result is a noticeably lighter, extremely sensitive instrument that can withstand the daily rigors of surgery.

SKLARLITE™ forceps carry the same day-in and day-out reliability that you have come to expect from all Sklar instruments. Sklar has applied its more than 100 years of experience in developing this superior instrument.

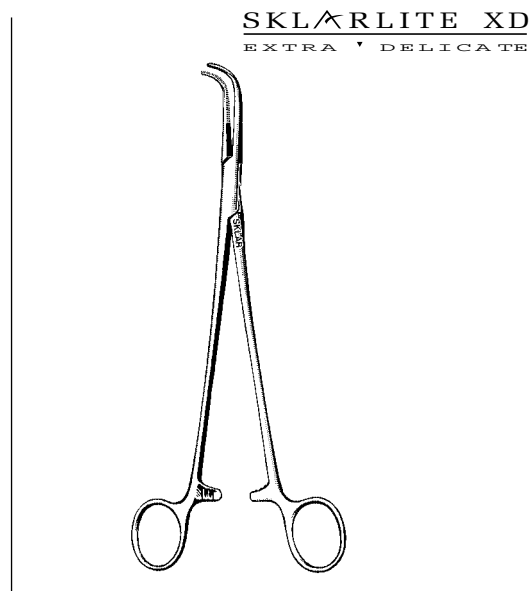
SKLARLITE™ forceps are covered under the same warranty that guarantees all Sklar instruments for a lifetime of dependable use.



SKLARLITE MIXER FORCEPS

Right Angle

23-2516 5½"
23-2520 7¼"



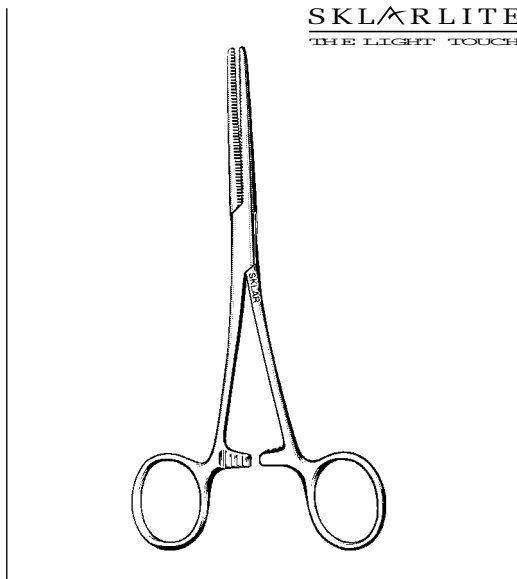
SKLARLITE EXTRA DELICATE MIXER FORCEPS

Right Angle

23-2521 5½"
23-2525 7"

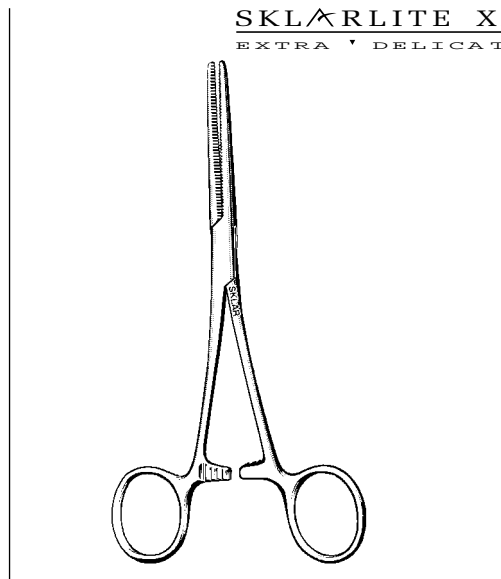
NEW!

SKLARLITE INSTRUMENTS



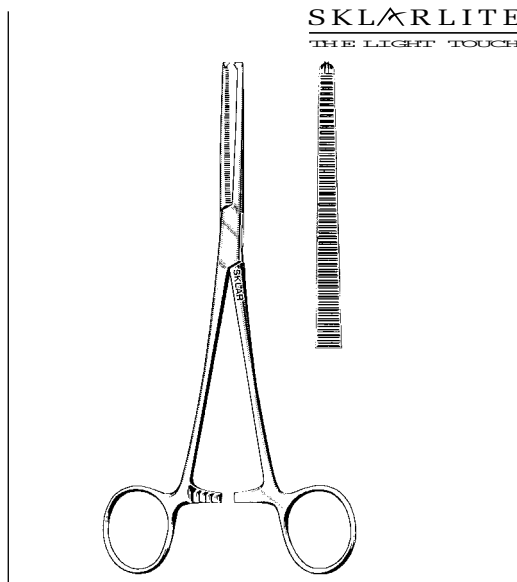
SKLARLITE ROCHESTER-PEAN FORCEPS

Straight		Curved	
23-2532	6 1/4"	23-2538	6 1/4"
		23-2542	7 1/4"



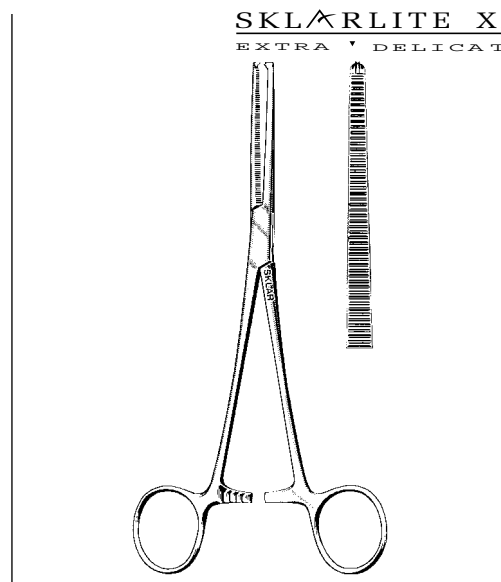
SKLARLITE EXTRA DELICATE ROCHESTER-PEAN FORCEPS

Curved	
23-2561	6 1/4"
23-2563	7 1/4"



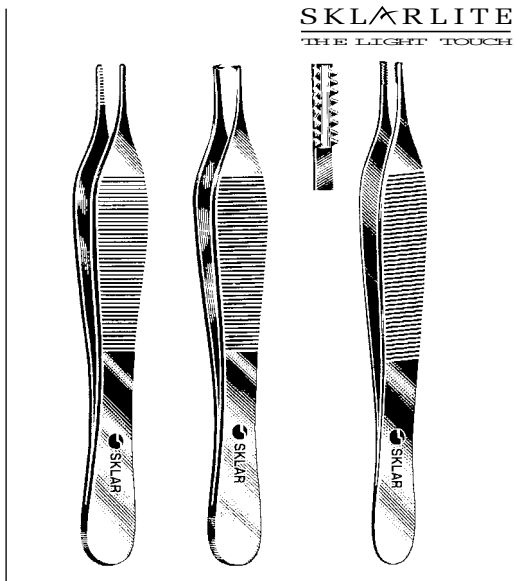
SKLARLITE ROCHESTER-OCHSNER FORCEPS

Straight 1x2 Teeth		Curved 1x2 Teeth	
23-2560	6 1/4"	23-2568	6 1/4"



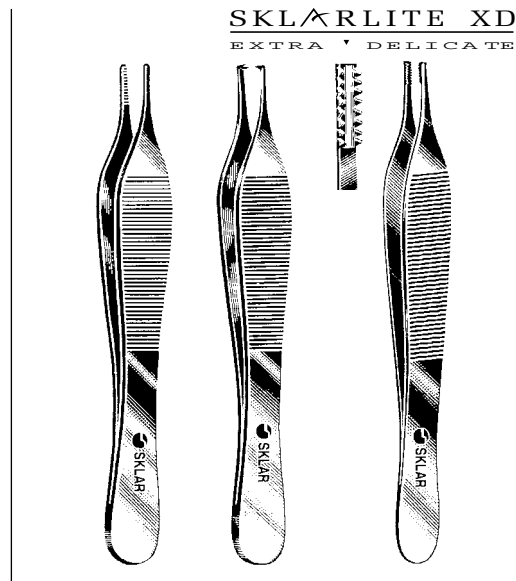
SKLARLITE EXTRA DELICATE ROCHESTER-OCHSNER FORCEPS

Straight 1x2 Teeth		Curved 1x2 Teeth	
23-2577	6 1/4"	23-2585	6 1/4"



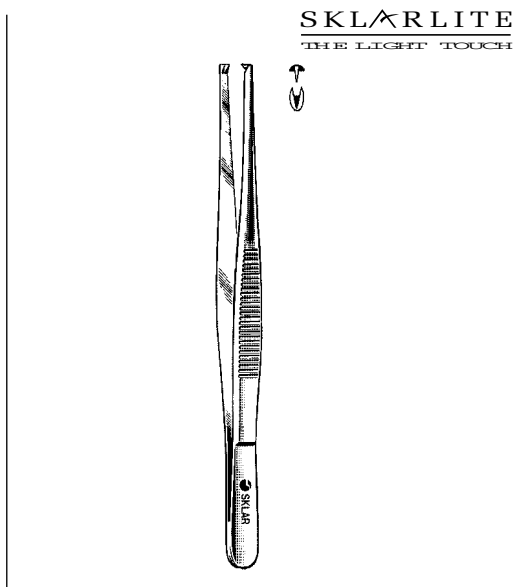
**SKLARLITE
ADSON FORCEPS**

Dressing
23-2600 4³/₄" Serrated
Tissue
23-2602 4³/₄" 1 X 2
Adson-Brown
23-2603 4³/₄" Side Grasping



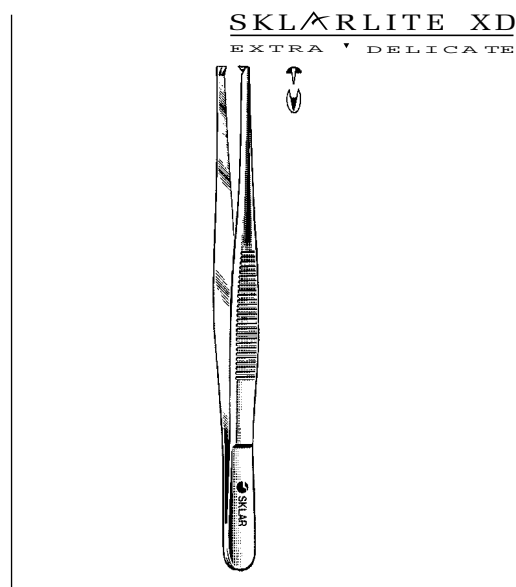
**SKLARLITE EXTRA DELICATE
ADSON FORCEPS**

Dressing
23-2604 4³/₄" Serrated
Tissue
23-2606 4³/₄" 1 X 2
Adson-Brown
23-2608 4³/₄" Side Grasping



**SKLARLITE
TISSUE FORCEPS**

1X2 teeth
23-2811 5¹/₂"



**SKLARLITE EXTRA DELICATE
TISSUE FORCEPS**

1X2 teeth
23-2819 5¹/₂"

NEW!

SKLARLITE INSTRUMENTS



SKLARLITE
THE LIGHT TOUCH



SKLARLITE DRESSING FORCEPS

Serrated

23-2824	4½"	23-2828	5½"
23-2826	5"	23-2830	6"

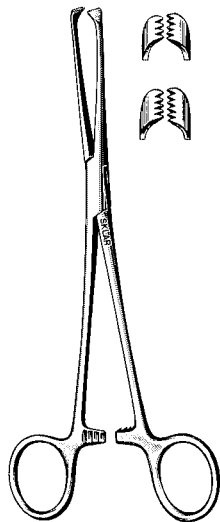
SKLARLITE XD
EXTRA DELICATE



SKLARLITE EXTRA DELICATE DRESSING FORCEPS

23-2834	4½"	23-2838	5½"
23-2836	5"	23-2840	6"

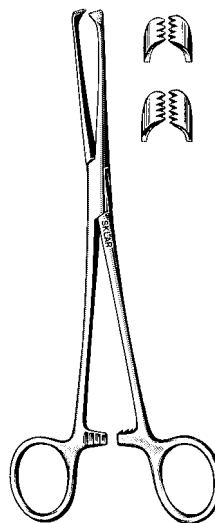
SKLARLITE
THE LIGHT TOUCH



SKLARLITE ALLIS TISSUE FORCEPS

23-2851	6"	4 X 5
23-2852	6"	5 X 6

SKLARLITE XD
EXTRA DELICATE



SKLARLITE EXTRA DELICATE ALLIS TISSUE FORCEPS

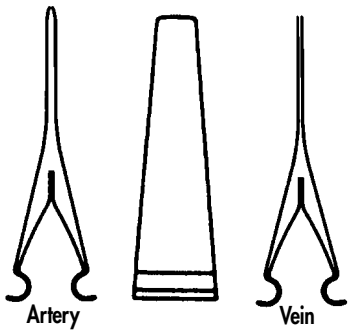
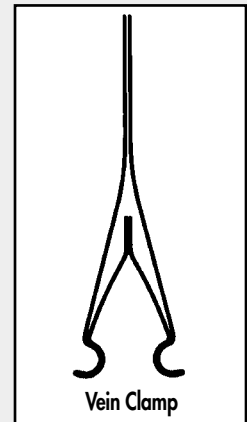
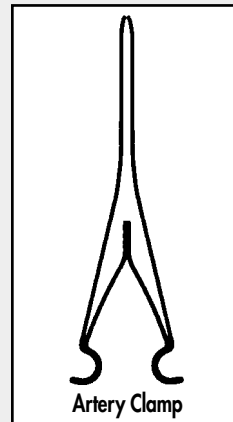
23-2861	5"	4 X 5	23-2864	6"	4 X 5
23-2862	5½"	4 X 5	23-2865	6"	5 X 6

Sklar Vascular Clamps

Sklar is proud to introduce our new vascular clamp line, the culmination of a decade of continuous development and improvement. The result is a clamp that is light, gentle and compact. With its wide, flat, gripping surfaces and carefully calibrated closing pressure, each clamp combines the maximum assurance of grip with the absolute minimum of trauma to the vessel wall.

Clamp Patterns for Arteries and Veins

In single and double forms, each size of clamp is available in a pattern for arteries, and a pattern for veins. The difference between them lies in a small but significant inward curvature of the blades near the very tip of the "Artery" pattern clamp. This important modification eliminates the dangerous tendency of a thick-walled artery to slide out of the end of a clamp which—like the "Vein" pattern—has perfectly flat jaws.



SINGLE CLAMP

Size 1 8 mm Long
 Vessel Size: .3-.8 mm
 98-7500 Artery Pattern
 98-7502 Vein Pattern

SINGLE CLAMP

Size 2 11 mm Long
 Vessel Size: .7-1.5 mm
 98-7505 Artery Pattern
 98-7507 Vein Pattern

SINGLE CLAMP

2 Per Pack

SINGLE CLAMP

Size 3 14 mm Long
 Vessel Size: 1.0-2.2 mm
 98-7510 Artery Pattern
 98-7512 Vein Pattern

SINGLE CLAMP

Size 4 17 mm Long
 Vessel Size: 2.0-3.5 mm
 98-7515 Artery Pattern
 98-7517 Vein Pattern

SINGLE CLAMP

Size 5 25 mm Long
 Vessel Size: 3.5-5 mm
 98-7520 Artery Pattern
 98-7522 Vein Pattern



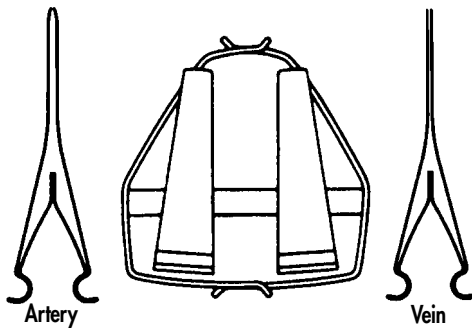
Sklar Double Vascular Clamps

Approximator with frame

The approximator with frame combines a smooth sliding approximation adjustment with the unique Sklar stay-suture holding frame. It is valuable for end-to-end anastomosis in a wide range of situations, particularly when skilled assistance is not available.

Approximator without frame

The approximator without frame is a useful general purpose approximator preferred when skilled assistance makes the suture-holding frame unnecessary, or when limited access does not allow space for the suture-holding frame.



DOUBLE CLAMP APPROXIMATOR WITH FRAME

Size 1 8 mm Long
 Vessel Size: .3-.8 mm
 98-7525 Artery Pattern
 98-7527 Vein Pattern

DOUBLE CLAMP APPROXIMATOR WITH FRAME

Size 2 11 mm Long
 Vessel Size: .7-1.5 mm
 98-7530 Artery Pattern
 98-7532 Vein Pattern

APPROXIMATOR WITH FRAME

Packed Each

DOUBLE CLAMP APPROXIMATOR WITH FRAME

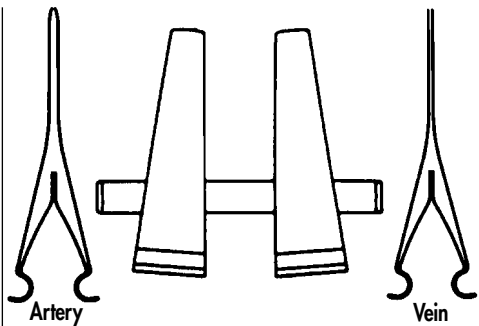
Size 3 14 mm Long
 Vessel Size: 1.0-2.2 mm
 98-7535 Artery Pattern
 98-7537 Vein Pattern

DOUBLE CLAMP APPROXIMATOR WITH FRAME

Size 4 17 mm Long
 Vessel Size: 2.0-3.5 mm
 98-7540 Artery Pattern
 98-7542 Vein Pattern

DOUBLE CLAMP APPROXIMATOR WITH FRAME

Size 5 25 mm Long
 Vessel Size: 3.5-5 mm
 98-7545 Artery Pattern
 98-7547 Vein Pattern



DOUBLE CLAMP APPROXIMATOR WITHOUT FRAME

Size 1 8 mm Long
 Vessel Size: .3-.8 mm
 98-7550 Artery Pattern
 98-7552 Vein Pattern

DOUBLE CLAMP APPROXIMATOR WITHOUT FRAME

Size 2 11 mm Long
 Vessel Size: .7-1.5 mm
 98-7555 Artery Pattern
 98-7557 Vein Pattern

APPROXIMATOR WITHOUT FRAME

Packed Each

DOUBLE CLAMP APPROXIMATOR WITHOUT FRAME

Size 3 14 mm Long
 Vessel Size: 1.0-2.2 mm
 98-7560 Artery Pattern
 98-7562 Vein Pattern

DOUBLE CLAMP APPROXIMATOR WITHOUT FRAME

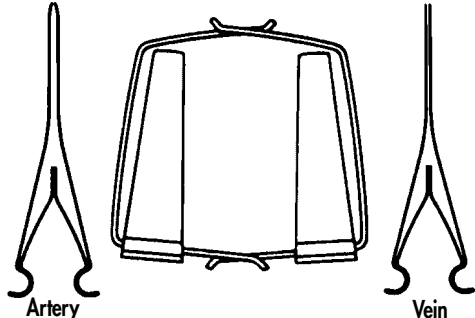
Size 4 17 mm Long
 Vessel Size: 2.0-3.5 mm
 98-7565 Artery Pattern
 98-7567 Vein Pattern

DOUBLE CLAMP APPROXIMATOR WITHOUT FRAME

Size 5 25 mm Long
 Vessel Size: 3.5-5 mm
 98-7570 Artery Pattern
 98-7572 Vein Pattern

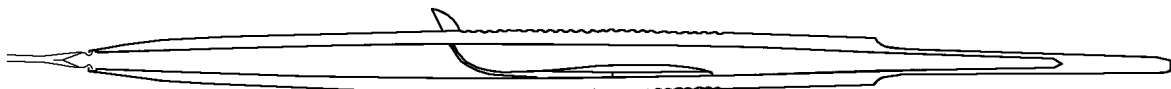
Sklar Double Vascular Clamps

The non-approximator with frame is a simple and inexpensive double clamp, useful in a number of practice and research procedures where approximation is not a requirement.

 <p>Artery</p> <p>Vein</p>	<p>DOUBLE CLAMP NON-APPROXIMATOR WITH FRAME</p> <p>Size 1 8 mm Long Vessel Size: .3-.8 mm 98-7575 Artery Pattern 98-7577 Vein Pattern</p>	<p>DOUBLE CLAMP NON-APPROXIMATOR WITH FRAME</p> <p>Size 2 11 mm Long Vessel Size: .7-1.5 mm 98-7580 Artery Pattern 98-7582 Vein Pattern</p>
<p>NON-APPROXIMATOR WITH FRAME Packed Each</p> <p>DOUBLE CLAMP NON-APPROXIMATOR WITH FRAME</p> <p>Size 3 14 mm Long Vessel Size: 1.0-2.2 mm 98-7585 Artery Pattern 98-7687 Vein Pattern</p>	<p>DOUBLE CLAMP NON-APPROXIMATOR WITH FRAME</p> <p>Size 4 17 mm Long Vessel Size: 2.0-3.5 mm 98-7590 Artery Pattern 98-7592 Vein Pattern</p>	<p>DOUBLE CLAMP NON-APPROXIMATOR WITH FRAME</p> <p>Size 5 25 mm Long Vessel Size: 3.5-5 mm 98-7595 Artery Pattern 98-7597 Vein Pattern</p>

Sklar Clamp Application Forceps

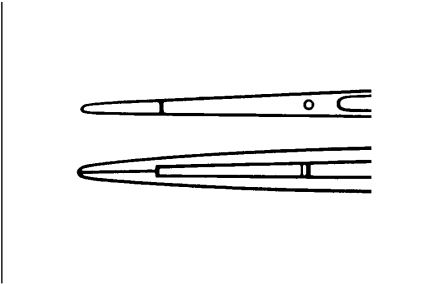
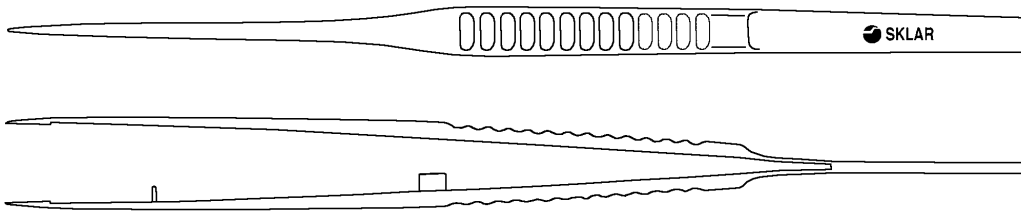
The ends of the Sklar clamps are supplied with grooves, and the applicator forceps are designed to engage the clamps positively. Due to this significant modification the clamps can be manipulated firmly in any plane without danger of slipping out. The action is direct – the clamp is opened by squeezing the forceps and closed by relaxing them. The applicator forceps are available with and without lock. The lock engages by squeezing the forceps, keeping the clamp's jaws half open. The forceps and the clamps can be made ready this way and then be handed to the surgeon. By light finger pressure the lock is disengaged after application of the clamp.



APPLICATION FORCEPS

98-7650 For Clamp sizes 1, 2, 3 Non-locking
98-7652 For Clamp sizes 3, 4, 5 Non-locking

98-7654 For Clamp sizes 1, 2, 3 Locking
98-7656 For Clamp sizes 3, 4, 5 Locking



MICRO FORCEPS

Straight Flat Handle

Straight Blunt Tip

98-7700 160 mm Long

98-7702 200 mm Long

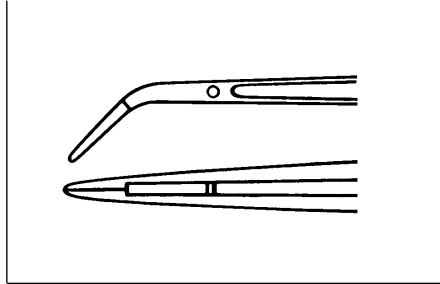
98-7704 240 mm Long

Straight Pointed Tip

98-7706 160 mm Long

98-7708 200 mm Long

98-7710 240 mm Long



MICRO FORCEPS

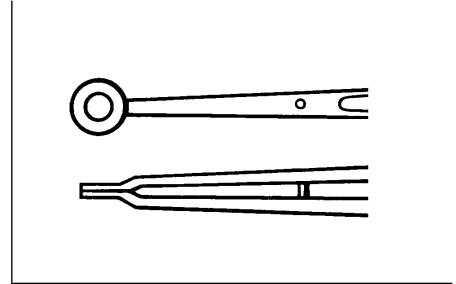
Straight Flat Handle

Angulated Blunt Tip

98-7712 160 mm Long

98-7714 200 mm Long

98-7716 240 mm Long

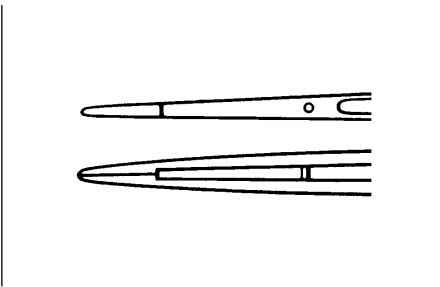
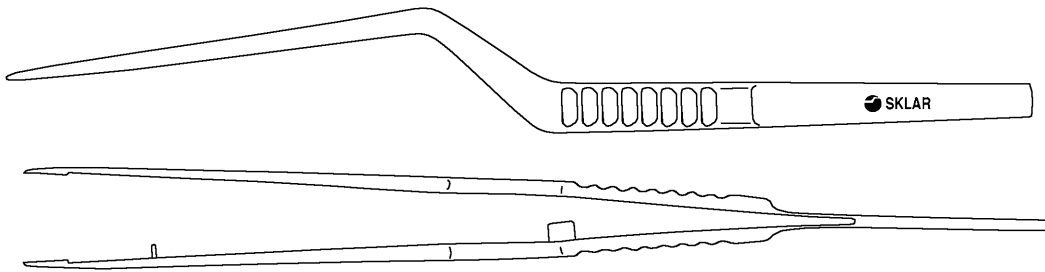


TUMOR GRASPING FORCEPS

Straight Flat Tip

98-7718 200 mm Long

98-7720 240 mm Long



MICRO FORCEPS

Bayonet Flat Handle

Straight Blunt Tip

98-7740 160 mm Long

98-7742 200 mm Long

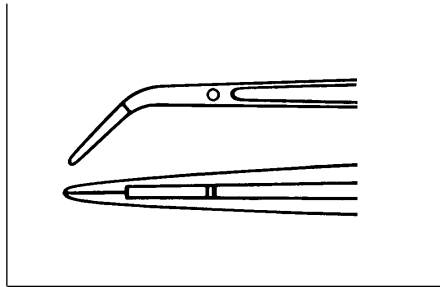
98-7744 240 mm Long

Straight Pointed Tip

98-7746 160 mm Long

98-7748 200 mm Long

98-7750 240 mm Long



MICRO FORCEPS

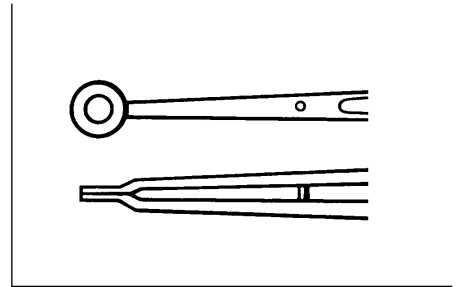
Bayonet Flat Handle

Angulated Blunt Tip

98-7752 160 mm Long

98-7754 200 mm Long

98-7756 240 mm Long

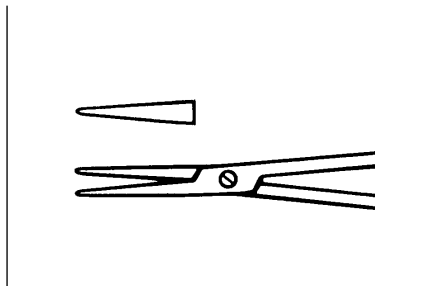
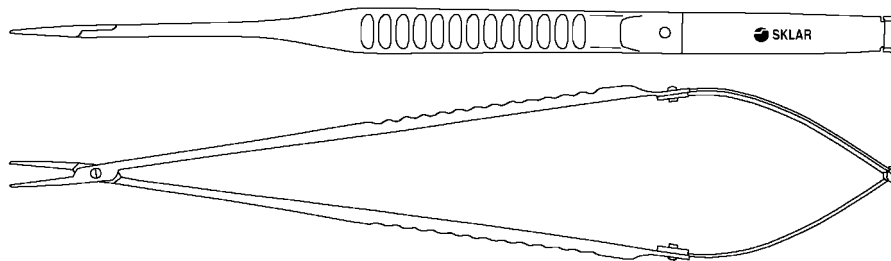


TUMOR GRASPING FORCEPS

Bayonet Flat Handle

98-7758 200 mm Long

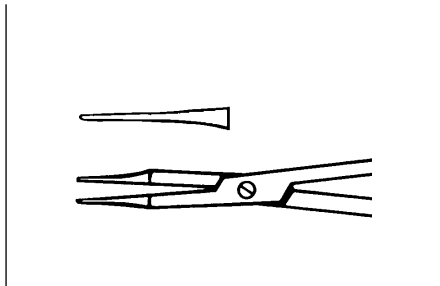
98-7760 240 mm Long



NEEDLE HOLDER

Straight Flat Handle
Straight Tip, without Lock

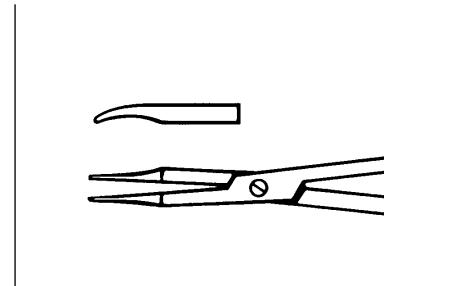
- 98-7780 160 mm Long
- 98-7782 200 mm Long
- 98-7784 240 mm Long



MICRO NEEDLE HOLDER

Straight Flat Handle
Straight Tip, without Lock

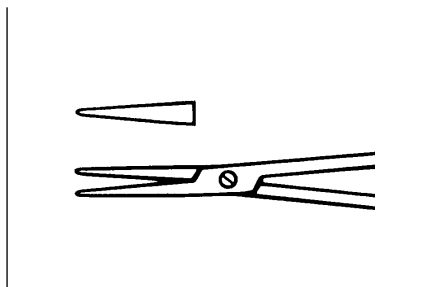
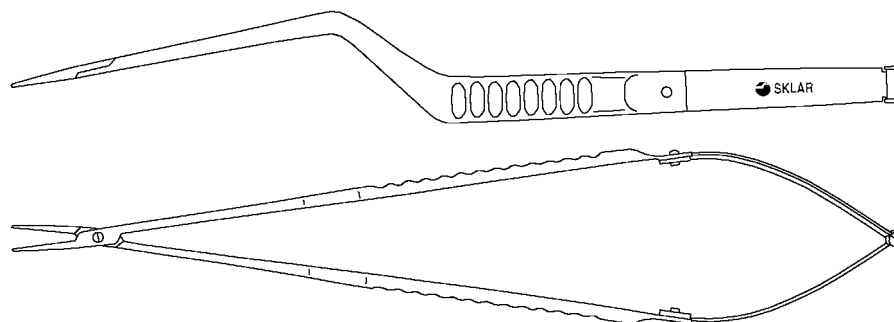
- 98-7786 160 mm Long
- 98-7788 200 mm Long
- 98-7790 240 mm Long



MICRO NEEDLE HOLDER

Slightly Curved Tip, without Lock

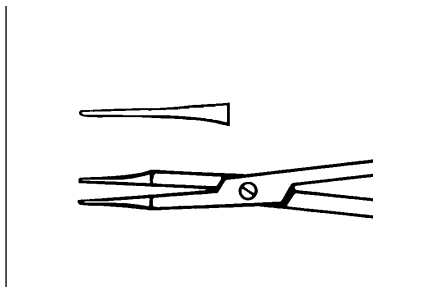
- 98-7792 160 mm Long
- 98-7794 200 mm Long
- 98-7796 240 mm Long



NEEDLE HOLDER

Bayonet Flat Handle (without Lock)
Straight Tip Straight Pointed Tip

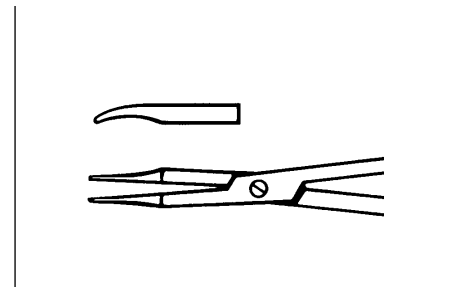
- 98-7820 160 mm Long 98-7826 160 mm Long
- 98-7822 200 mm Long 98-7828 200 mm Long
- 98-7824 240 mm Long 98-7830 240 mm Long



MICRO NEEDLE HOLDER

Bayonet Flat Handle (without Lock)
Straight Tip

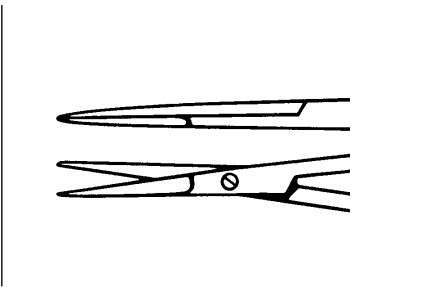
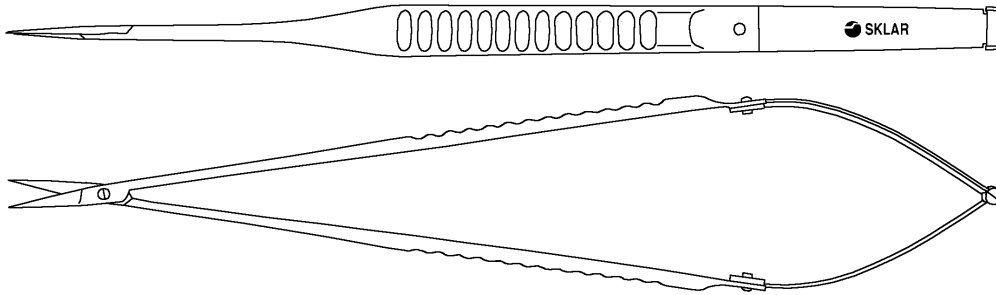
- 98-7832 160 mm Long
- 98-7834 200 mm Long
- 98-7836 240 mm Long



MICRO NEEDLE HOLDER

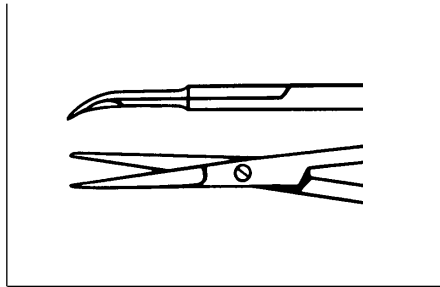
Bayonet Flat Handle (without Lock)
Slightly Curved

- 98-7838 160 mm Long
- 98-7840 200 mm Long
- 98-7842 240 mm Long



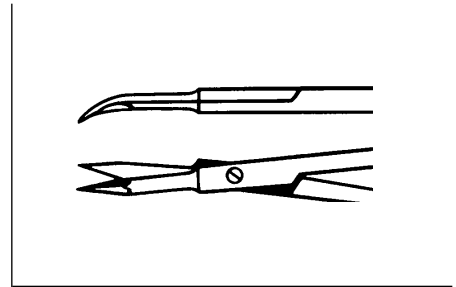
MICRO SCISSORS

Straight Flat Handle
Straight Tip
98-7860 160 mm Long
98-7862 200 mm Long
98-7864 240 mm Long



MICRO SCISSORS

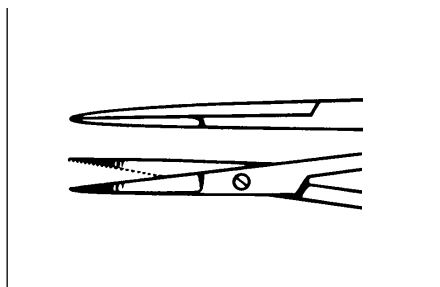
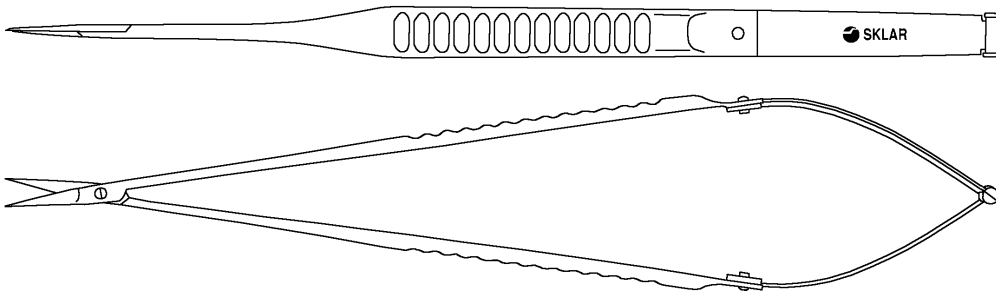
Straight Flat Handle
Curved Tip
98-7866 160 mm Long
98-7868 200 mm Long
98-7870 240 mm Long



MICRO SCISSORS

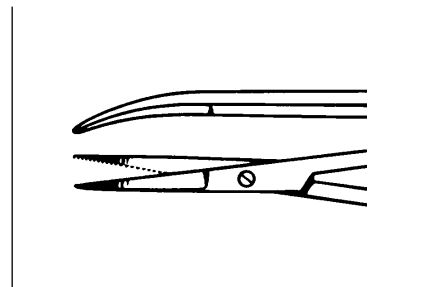
Straight Flat Handle
Curved Tip Vannas Blades
98-7872 160 mm Long
98-7874 200 mm Long
98-7876 240 mm Long

Straight Flat Handle
Straight Tip Vannas Blades
98-7277 160 mm Long
98-7278 200 mm Long
98-7279 240 mm Long



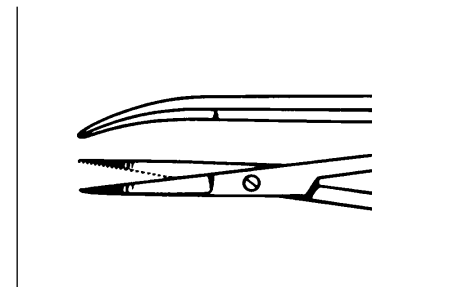
SCISSORS

Straight Flat Handle
Straight Tip Toothed Blades
98-7890 160 mm Long
98-7892 200 mm Long
98-7894 240 mm Long



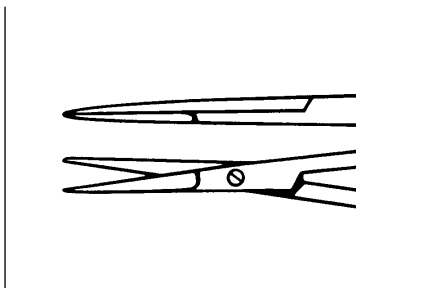
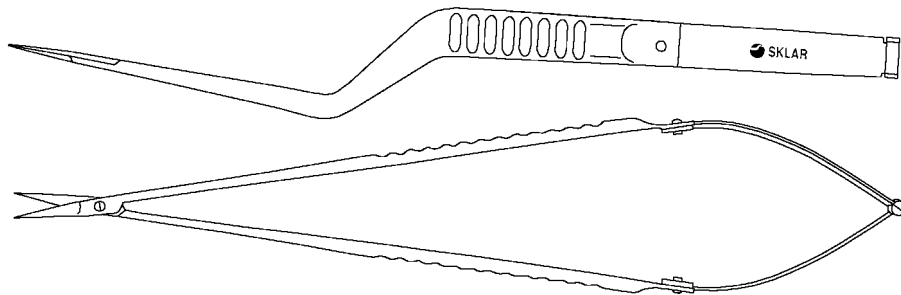
SCISSORS

Straight Flat Handle
Curved Tip Toothed Blades
98-7896 160 mm Long
98-7898 200 mm Long
98-7900 240 mm Long



SCISSORS

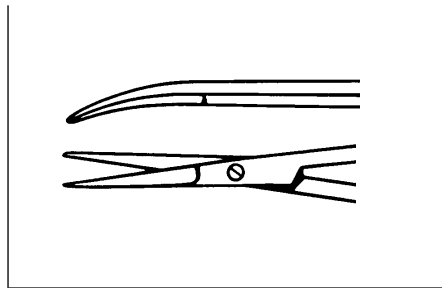
Straight Flat Handle
Angulated Tip Vannas Blades
98-7902 160 mm Long
98-7904 200 mm Long
98-7906 240 mm Long



MICRO SCISSORS

Bayonet Flat Handle
Straight Tip

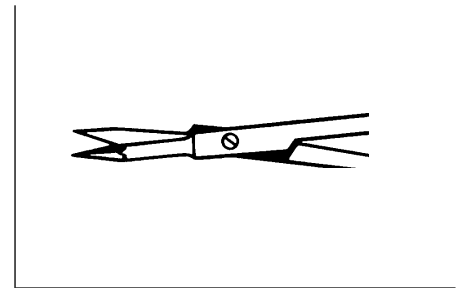
- 98-7920 160 mm Long
- 98-7922 200 mm Long
- 98-7924 240 mm Long



MICRO SCISSORS

Bayonet Flat Handle
Curved Tip

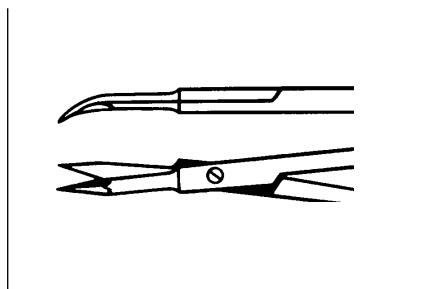
- 98-7926 160 mm Long
- 98-7928 200 mm Long
- 98-7930 240 mm Long



MICRO SCISSORS

Bayonet Flat Handle
Straight Tip Vannas Blades

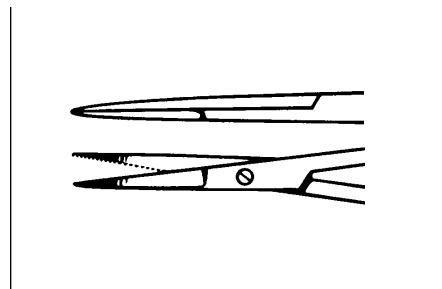
- 98-7932 160 mm Long
- 98-7934 200 mm Long
- 98-7936 240 mm Long



MICRO SCISSORS

Bayonet Flat Handle
Curved Tip Vannas Blades

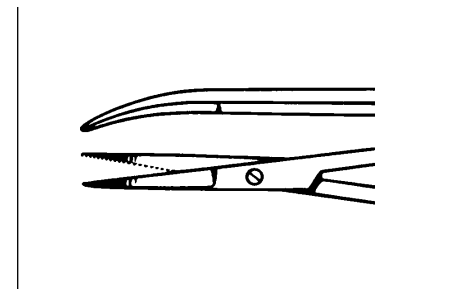
- 98-7950 160 mm Long
- 98-7952 200 mm Long
- 98-7954 240 mm Long



SCISSORS

Bayonet Flat Handle
Straight Tip Toothed Blades

- 98-7956 160 mm Long
- 98-7958 200 mm Long
- 98-7960 240 mm Long



SCISSORS

Bayonet Flat Handle
Curved Tip Toothed Blades

- 98-7962 160 mm Long
- 98-7964 200 mm Long
- 98-7966 240 mm Long

SCISSORS

Bayonet Flat Handle
Angulated Tip Vannas Blades

- 98-7968 160 mm Long
- 98-7970 200 mm Long
- 98-7972 240 mm Long

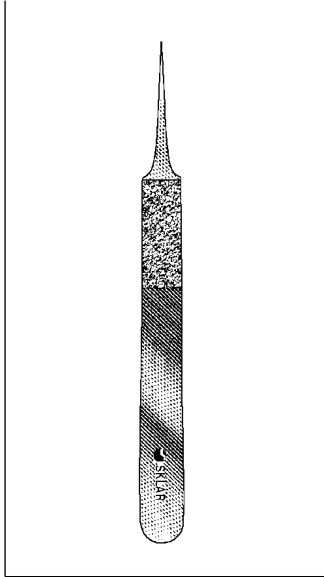
SCISSORS

Bayonet Flat Handle
125° Angulated Blades

- 98-7974 160 mm Long
- 98-7976 200 mm Long
- 98-7978 240 mm Long

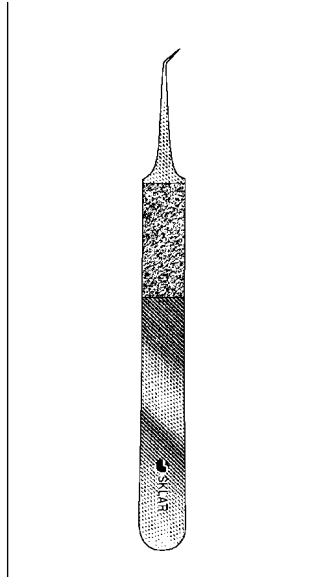
Sklar Micro-Grip™

This newly developed gripping surface reduces the point pressure on the fingertips. This lessens the strain on the surgeon's hand for maximum ergonomic comfort.



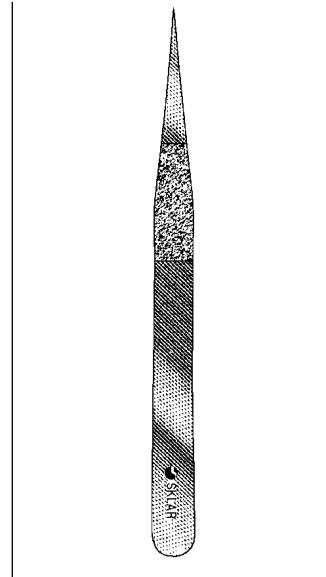
SKLAR MICRO-GRIP™ MICROSURGICAL FORCEPS

Flat Handle 9 mm wide
98-8000 11 cm Long Straight
Tip Diameter 0.3 mm



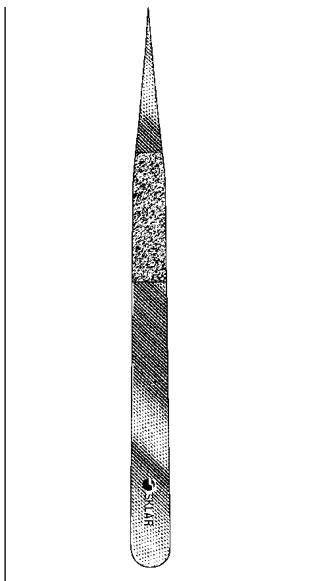
SKLAR MICRO-GRIP™ MICROSURGICAL FORCEPS

Flat Handle 9 mm wide
98-8005 11 cm Long Angulated 45°
Tip Diameter 0.3 mm



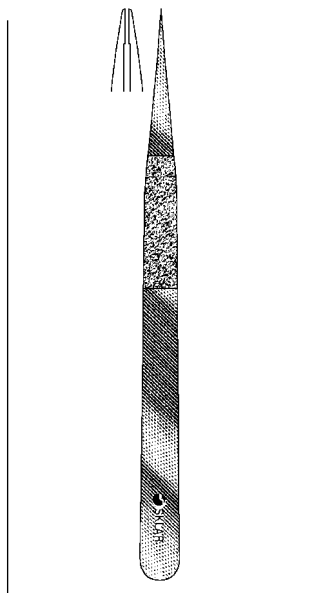
SKLAR MICRO-GRIP™ MICROSURGICAL FORCEPS

Flat Handle 9 mm wide
98-8010 12 cm Long Straight
Tip Diameter 0.3 mm



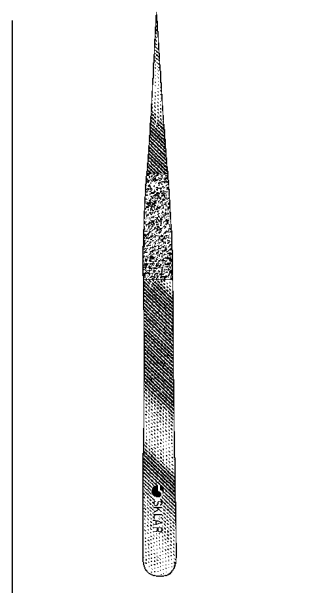
SKLAR MICRO-GRIP™ MICROSURGICAL FORCEPS

Flat Handle 9 mm wide
98-8015 13.5 cm Long Straight
Tip Diameter 0.3 mm



SKLAR MICRO-GRIP™ MICROSURGICAL FORCEPS

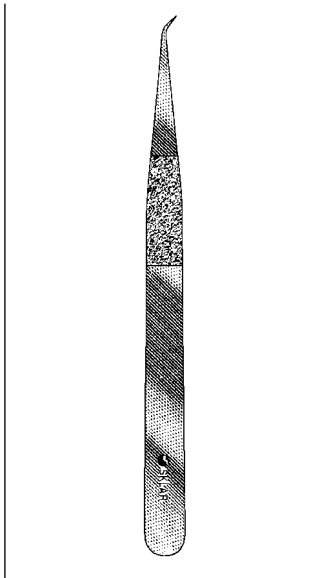
Flat Handle 9 mm wide
98-8020 13.5 cm Long Straight
Tip Diameter 0.3 mm with
tying platform



SKLAR MICRO-GRIP™ MICROSURGICAL FORCEPS

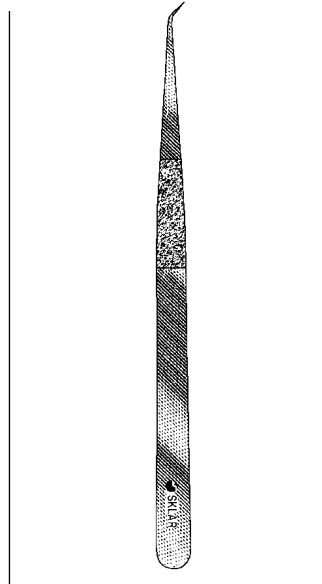
Flat Handle 7 mm wide
98-8025 13.5 cm Long Straight
Tip Diameter 0.3 mm

This newly developed gripping surface reduces the point pressure on the fingertips. This lessens the strain on the surgeon's hand for maximum ergonomic comfort.



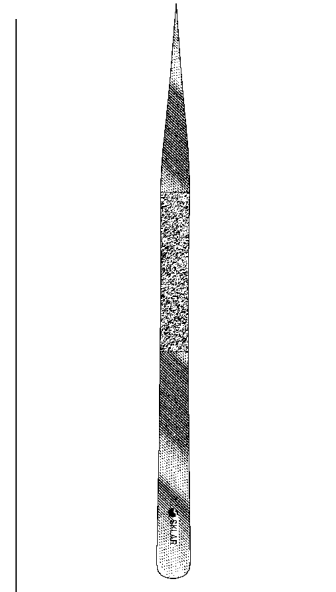
SKLAR MICRO-GRIP™ MICROSURGICAL FORCEPS

Flat Handle 9 mm wide
98-8030 13.5 cm Long Angulated 45°
Tip Diameter 0.3 mm



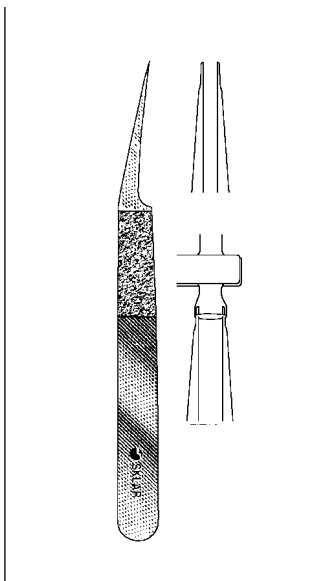
SKLAR MICRO-GRIP™ MICROSURGICAL FORCEPS

Flat Handle 7 mm wide
98-8035 13.5 cm Long Angulated 45°
Tip Diameter 0.3 mm



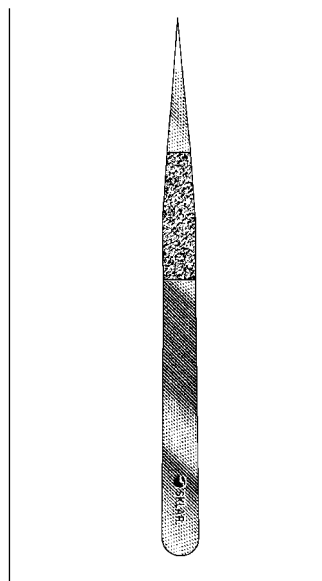
SKLAR MICRO-GRIP™ MICROSURGICAL FORCEPS

Flat Handle 9 mm wide
98-8040 18 cm Long Straight
Tip Diameter 0.5 mm



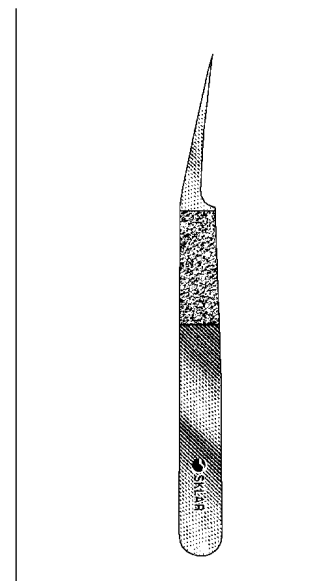
SKLAR MICRO-GRIP™ VESSEL DILATORS

Flat Handle 9 mm wide
98-8045 11 cm Long Angulated 10°
Tip Diameter 0.3 mm
Highly modified forceps, with elongated, parallel tips which are highly polished. Designed for controlled intraluminal vessel dilation.



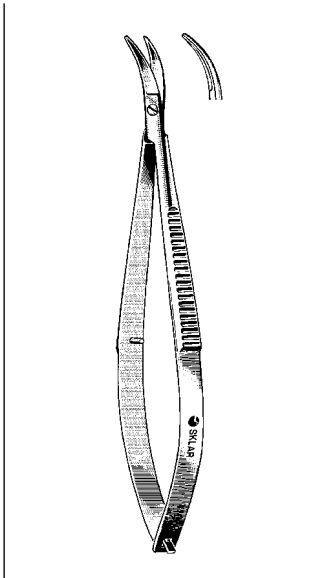
SKLAR MICRO-GRIP™ VESSEL DILATORS

Flat Handle 9 mm wide
98-8050 13.5 cm Long Straight
Tip Diameter 0.3 mm with
tying platform
Highly modified forceps, with elongated, parallel tips which are highly polished. Designed for controlled intraluminal vessel dilation.



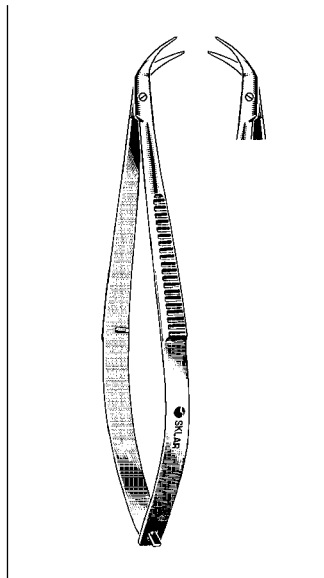
SKLAR MICRO-GRIP™ VESSEL DILATORS

Flat Handle 9 mm wide
98-8055 11 cm Long Angulated 10°
Tip Diameter 0.2 mm
Highly modified forceps, with elongated, parallel tips which are highly polished. Designed for controlled intraluminal vessel dilation.



CASTROVIEJO CORNEAL SCISSORS

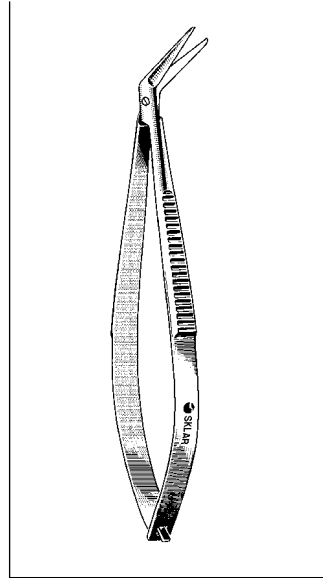
64-2442 4" Curved blunt blades



CASTROVIEJO CORNEAL SCISSORS

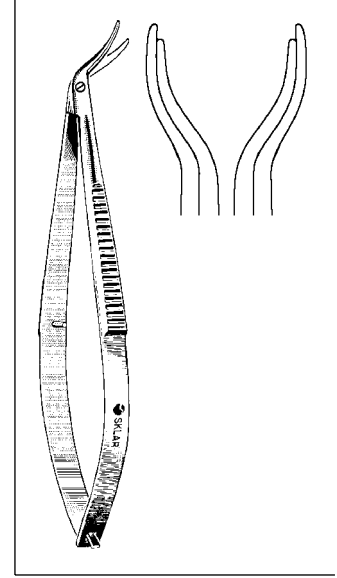
Miniature with inner blade 0.5 mm longer than outer blade

64-2242 4 1/4" Curved right
64-2342 4 1/4" Curved left



CASTROVIEJO CORNEAL SCISSORS

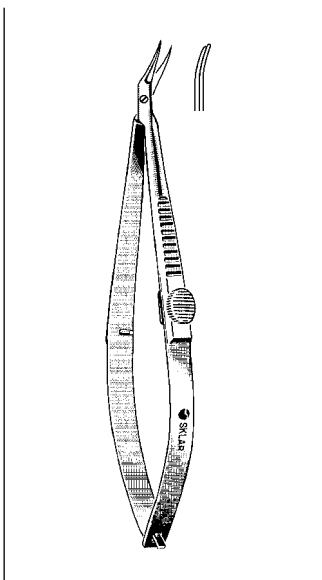
64-2535 3 1/2" 13 mm blunt angled blades



CASTROVIEJO CATARACT SCISSORS

64-3290 4" Angled blades to facilitate manipulation and curved to conform to the curve of the limbus. Curved right.

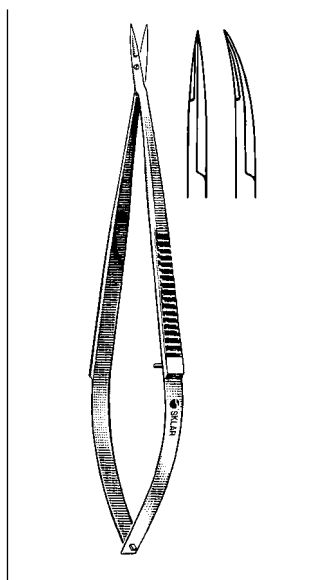
64-3292 4" Longer blade rounded to minimize trauma to corneal endothelium and iris. Curved left.



CASTROVIEJO CORNEAL SCISSORS

Right sub-miniature for micro surgery

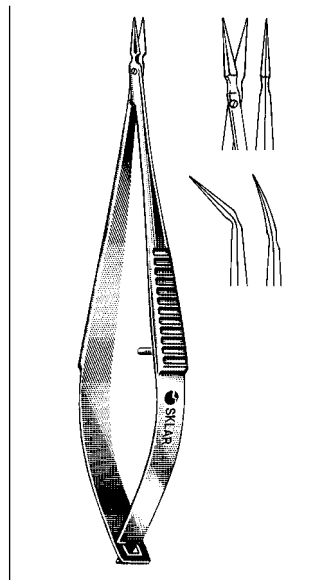
64-3294 4" Right
64-3296 4" Left



IRIS MICRO-MINIATURE SCISSORS

Extra delicate, sharp points

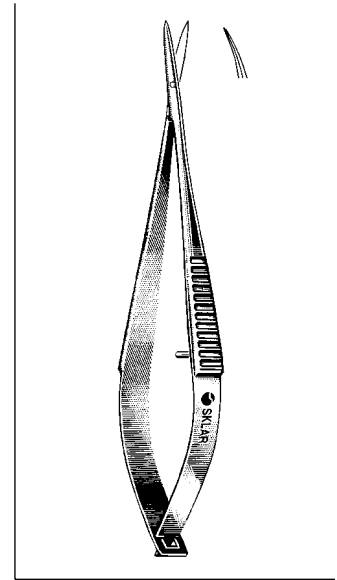
64-3050 4" Straight
64-3052 4" Curved



VANNAS SPRING HANDLE SCISSORS

Very Delicate

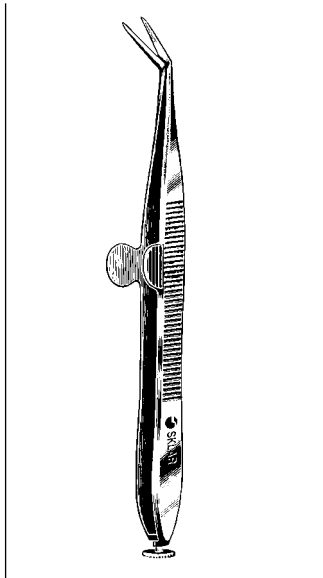
64-1950 3" Straight
64-1951 3" Curved
64-1952 3" Angular



McPHERSON-VANNAS SCISSORS

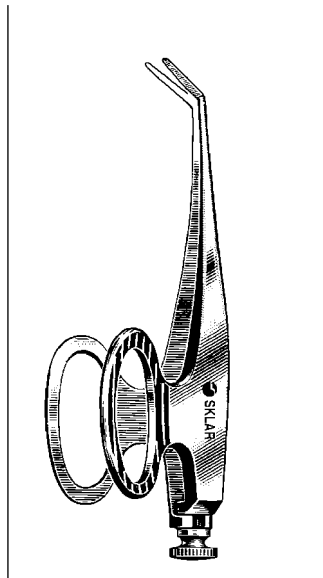
Very Delicate

64-1960 3" Straight
64-1961 3" Curved



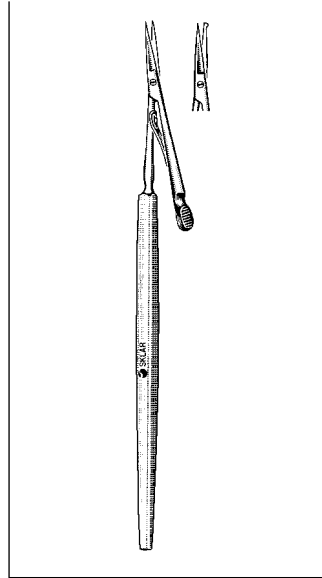
DEWECKER IRIS SCISSORS

Angled
 64-3042 4 1/4" Sharp/Blunt
 64-2942 4 1/4" Sharp/Sharp



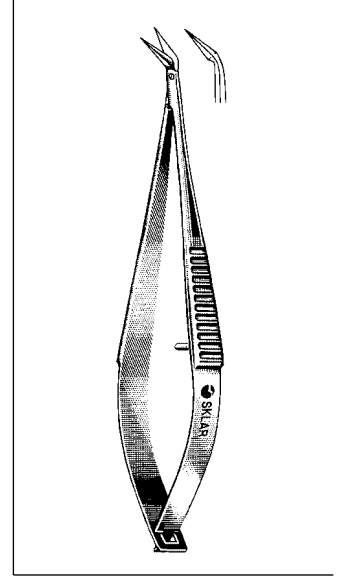
BARRAQUER-DEWECKER IRIS SCISSORS

64-3225 2 1/4" Fine 7 mm blades
 64-3228 2 1/4" Delicate 10 mm blades



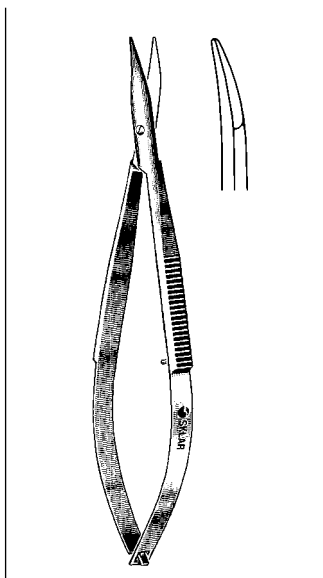
NOYES IRIDECTOMY SCISSORS

7 mm Straight
 64-2555 5 1/2" Sharp/Sharp
 64-2655 5 1/2" Sharp with one Probe Point



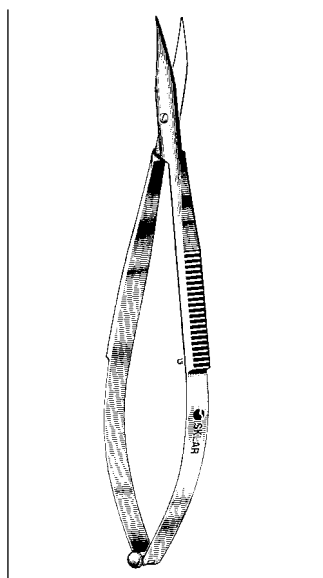
WILMER SCISSORS

Angular
 64-1735 4"



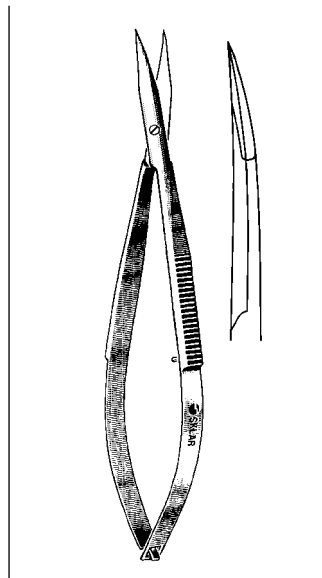
WESTCOTT TENOTOMY SCISSORS

64-3146 4 1/4" Blunt tips with spring handle



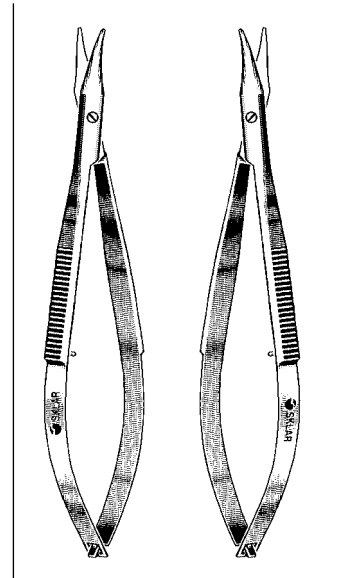
WESTCOTT TENOTOMY SCISSORS

64-3142 13 cm Right
 64-3144 13 cm Left



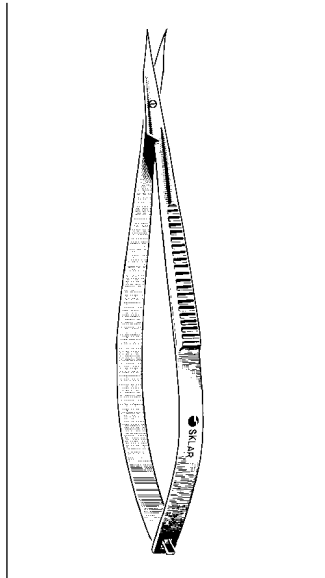
WESTCOTT SCISSORS

64-3145 4 1/4" Sharp tips with spring handle



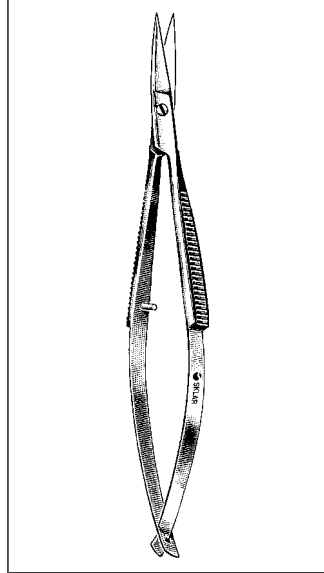
SCHEIE-WESTCOTT CORNEAL SECTION SCISSORS

64-3138 5" Right
 64-3140 5" Left



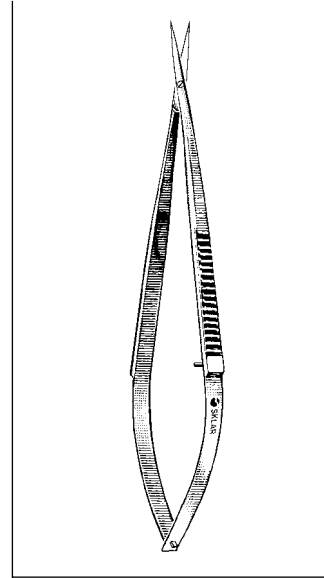
SHEPARD-WESTCOTT SCISSORS

Serrated upper blade
64-3148 120 mm



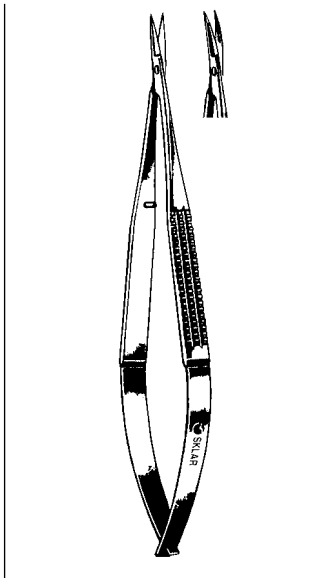
McCLURE SPRING HANDLE SCISSORS

64-1742 4 1/4" Angled
64-1842 4 1/4" Straight
64-1942 4 1/4" Curved



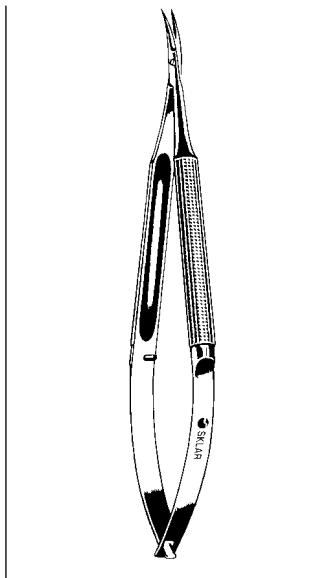
FINE STITCH SCISSORS

64-3260 4 1/4" Delicate sharp blades



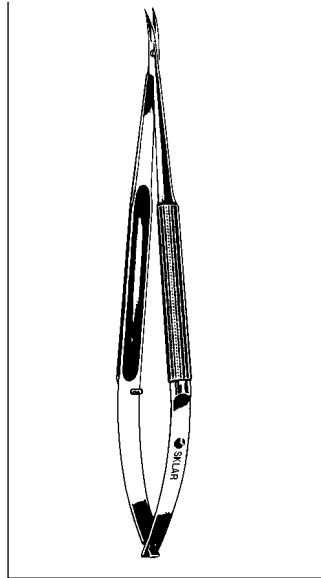
MICRO SURGERY SCISSORS

6" Sharp Points Flat Handle
98-7810 Straight
98-7812 Curved



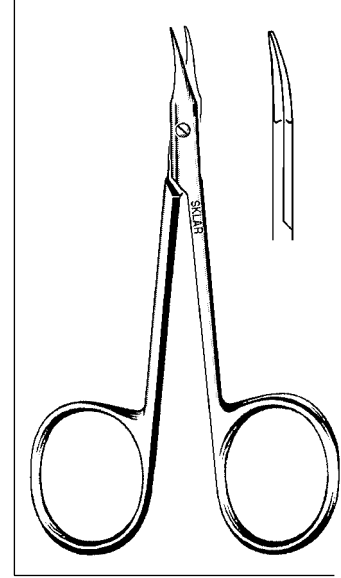
MICRO SURGERY SCISSORS

6" Sharp Points Round Handle
98-7814 Straight
98-7815 Curved



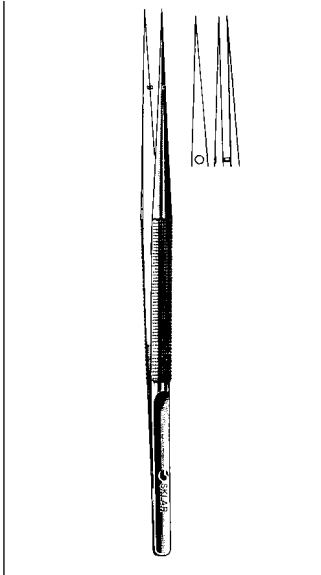
MICRO SURGERY SCISSORS

7 1/8" Round Handle
98-7816 Straight
98-7817 Curved

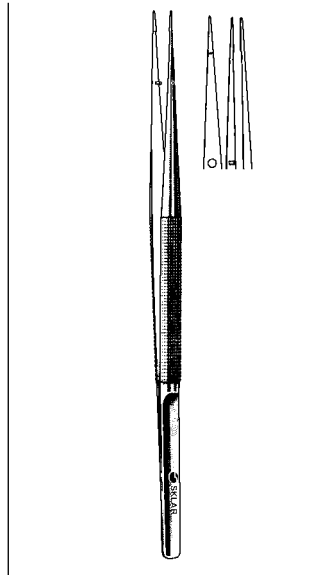


GRADLE-SCISSORS

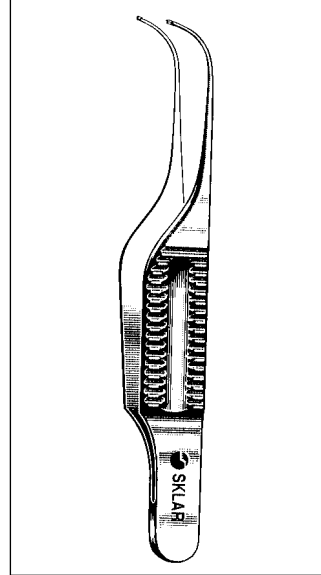
Slightly Curved, Sharp
64-3280 3 1/2"



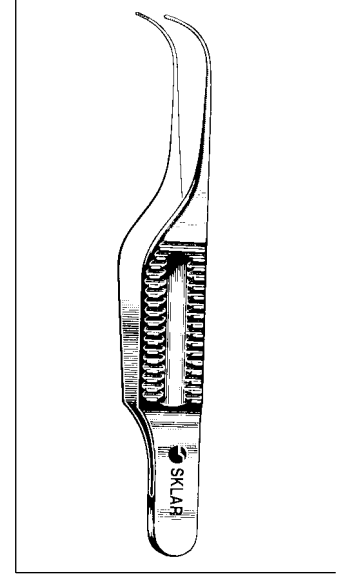
RHOTON MICRO SUTURE FORCEPS
 7" 0.7 mm Tying Platform
 98-3055 Straight



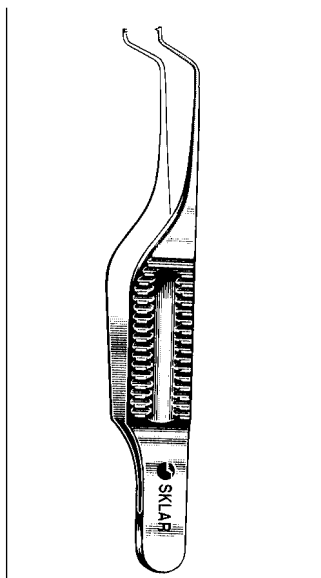
RHOTON MICRO FORCEPS
 98-3056 7" Straight



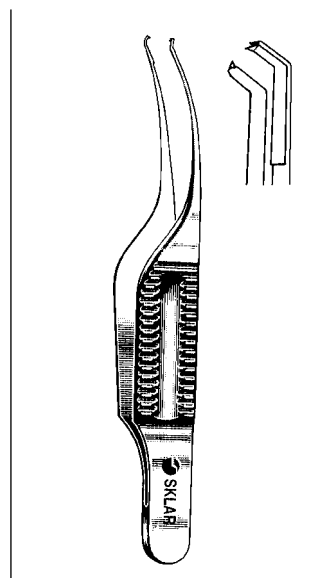
GILL FORCEPS
 66-7130 Iris Curved, length 3" (7.6 cm)
 66-7230 Curved Extra Delicate length 3" (7.6 cm)



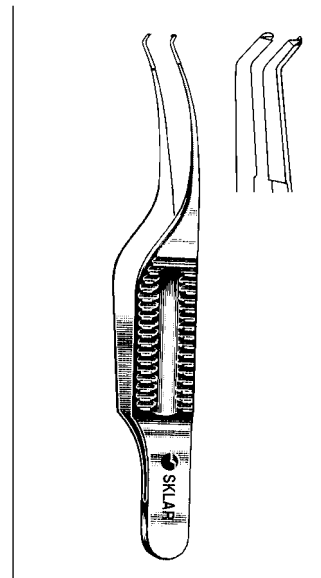
GILL (CHANDLER) IRIS FORCEPS
 66-7244 3" Fine cross serrated tips 0.6 mm wide



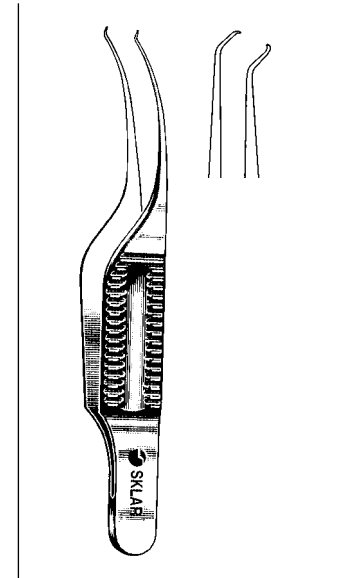
GILL-HESS IRIS FORCEPS
 66-7238 2 3/4" with 1 x 2 teeth forward 0.5 mm
 66-7240 2 3/4" with 1 x 2 teeth down 0.5 mm



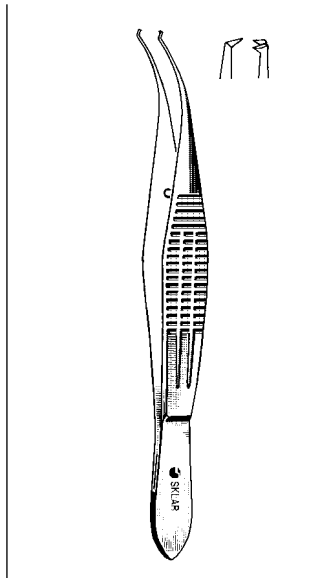
TROUTMAN-BARRAQUER CORNEAL UTILITY FORCEPS
 Colibri Type
 66-7248 1 x 2 overlapping teeth 0.5 mm



TROUTMAN-BARRAQUER CORNEAL UTILITY FORCEPS
 Colibri Type
 66-7250 1 x 2 0.5 mm teeth, set at 45° with tying platform

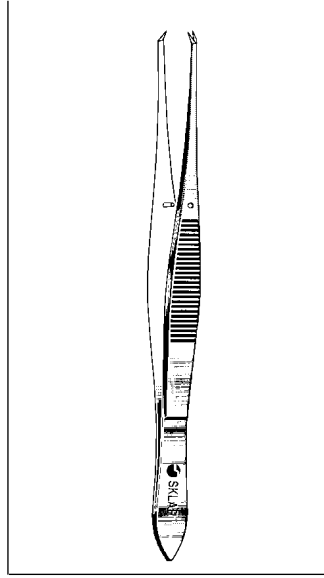


COLIBRI CORNEAL UTILITY FORCEPS
 7.5 cm
 66-7259 1 x 2 teeth, 0.12 mm
 66-7261 1 x 2 teeth, 0.4 mm



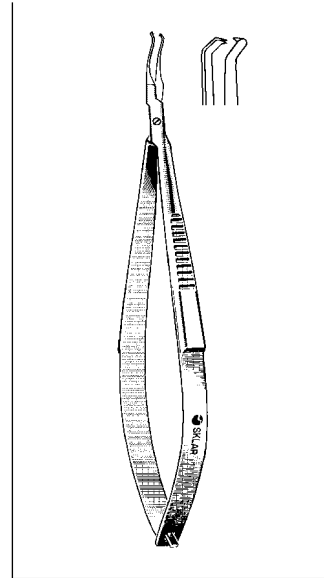
**CASTROVIEJO COLIBRI
FORCEPS**

Wide Handle 4.25" Extra Delicate
66-3450 1 x 2 0.12 mm teeth



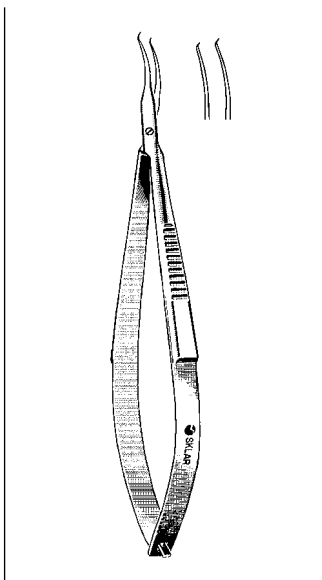
**O'BRIEN-ELSCHNIG
FORCEPS**

66-2440 4" (10.2 cm) Delicate
66-2540 4" (10.2 cm) Without catch



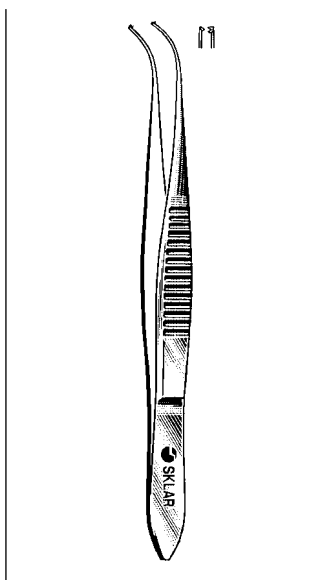
**MAUMENEE COLIBRI
CORNEAL FORCEPS**

1 x 2 teeth 123 mm
66-3455 0.12 mm teeth Set at 90°



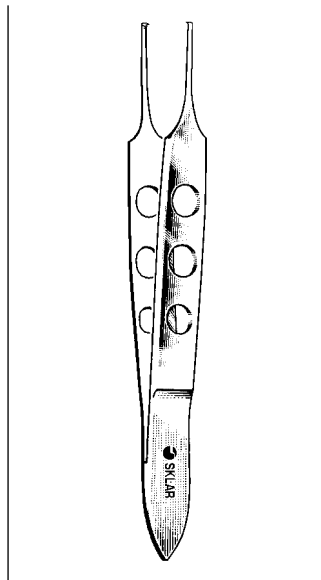
**MAUMENEE COLIBRI
CORNEAL FORCEPS**

Cross action with tying
platform set at 45° 3.5"
66-3460 1 x 1 0.1 mm teeth
66-3462 1 x 2 0.12 mm teeth



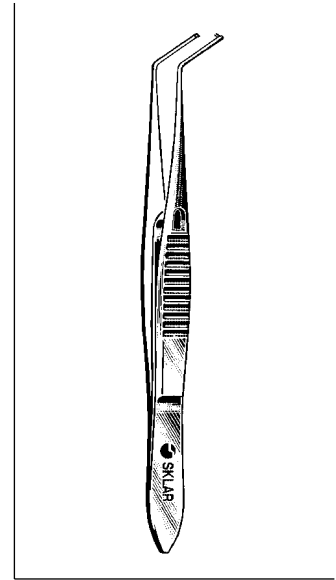
FORESTER IRIS FORCEPS

3 3/4" Curved tips, 1 x 2 teeth on
outside of curve
66-4530 Standard handle



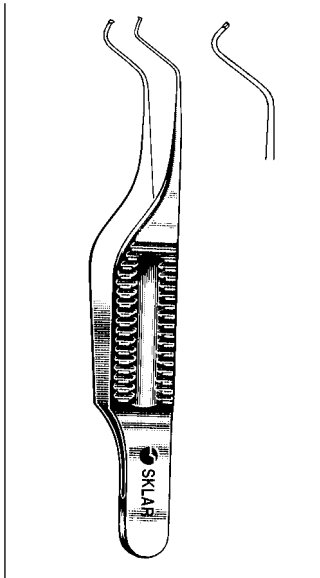
**IOWA STATE FIXATION
FORCEPS**

1 x 2 straight teeth, Delicate tip
66-4232 3 3/4"



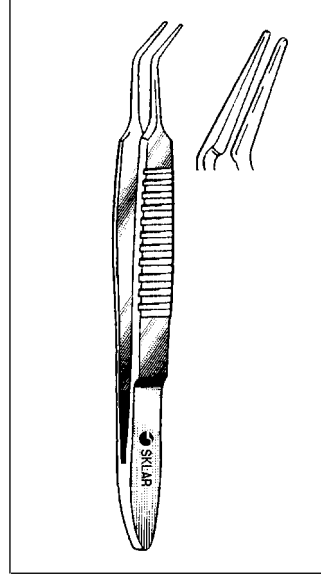
**O'CONNOR IRIS
FORCEPS**

66-3350 3 3/4" Angular jaws
0.5 x 9 mm with 1 x 2 teeth



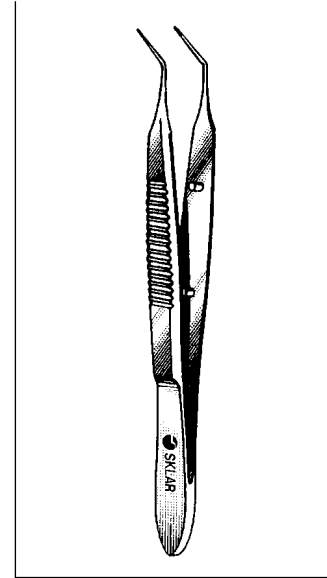
BOTVIN IRIS FORCEPS

66-7258 2 $\frac{1}{8}$ " fine cross serrated tips,
0.5 mm wide
66-7260 2 $\frac{1}{8}$ " with 1 x 2 teeth
0.5 mm wide



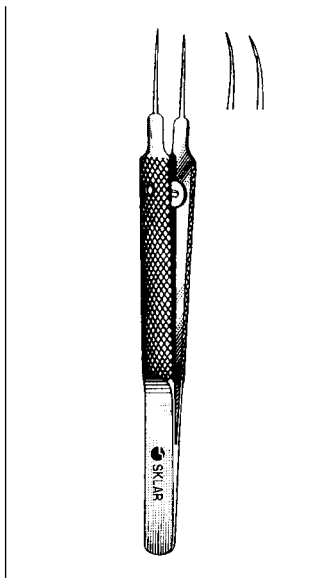
BECHERT-McPHERSON TYING FORCEPS

10 mm tying platform
83 mm
66-6178 Smooth jaws, angled



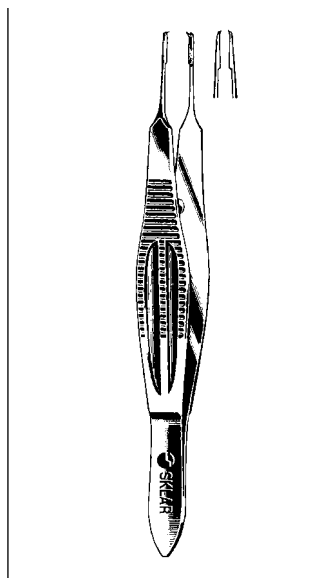
KELMAN-McPHERSON TYING FORCEPS

With tying platform 7.5 mm long
0.3 mm tip width Angled 3.31"
66-6180



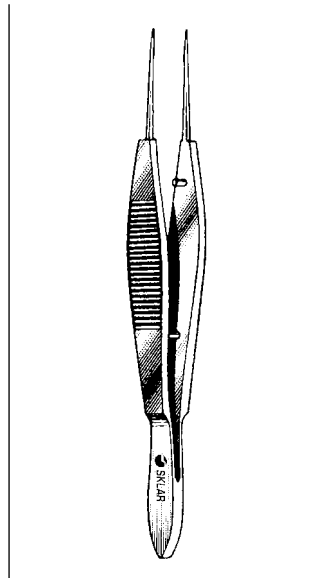
TENNANT TYING FORCEPS

Extra delicate Round handle tying platform 6 mm
0.3 mm tip width
66-6194 Straight 4"
66-6196 Curved 4"



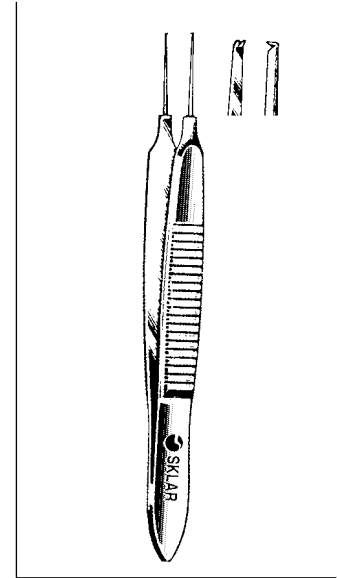
CASTROVIEJO SUTURE FORCEPS

4 $\frac{1}{4}$ " 1 x 2 Platform behind teeth limits depth of penetration
Wide handle
66-6115 0.5 mm delicate teeth
66-6118 1.5 mm delicate teeth



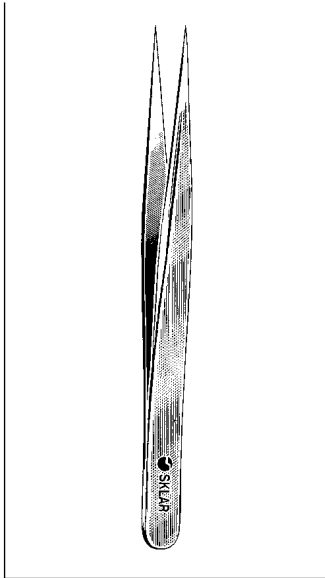
BONN TYING FORCEPS

With tying platform 0.3 mm tip width
66-6160 Straight 4"
66-6162 Curved 4"



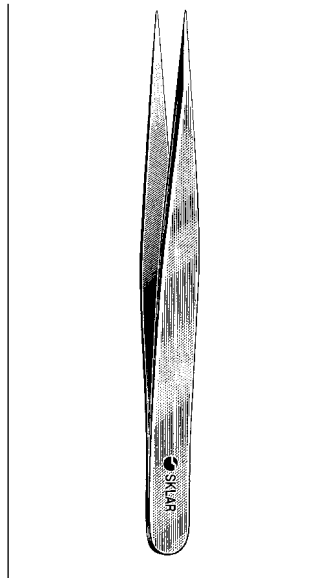
BONN MICRO SUTURING FORCEPS

66-6125 2 $\frac{3}{8}$ " 1 x 2 teeth
0.12 mm with tying platform
66-6126 3 $\frac{3}{8}$ " 1 x 2 teeth
0.12 mm with tying platform



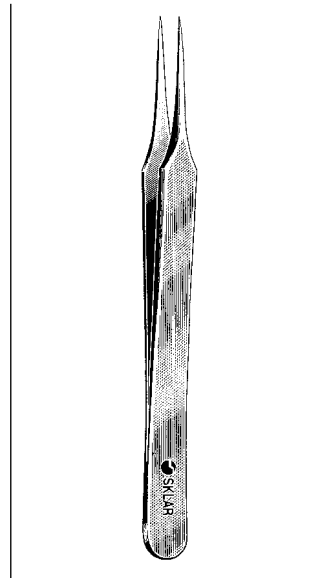
**JEWELLERS STYLE
FORCEPS**

66-7447 #3 Straight



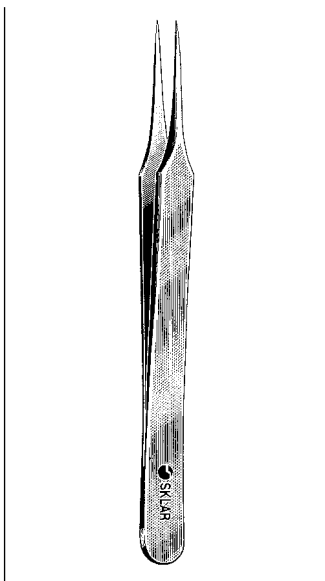
**JEWELLERS STYLE
FORCEPS**

66-7442 #3C Straight Delicate



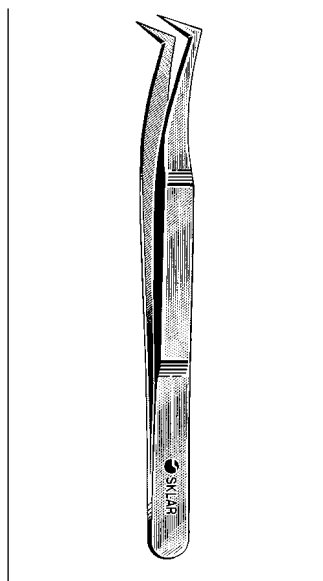
JEWELLERS STYLE FORCEPS

66-7542 #4 Straight Delicate



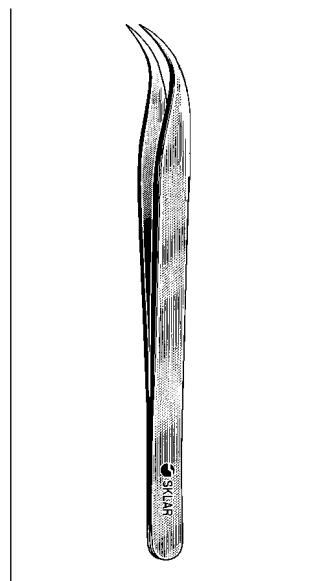
**JEWELLERS STYLE
FORCEPS**

66-7642 #5 Straight



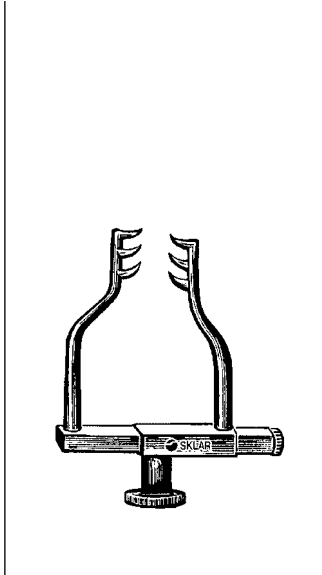
**JEWELLERS STYLE
FORCEPS**

66-7644 #6 Angled

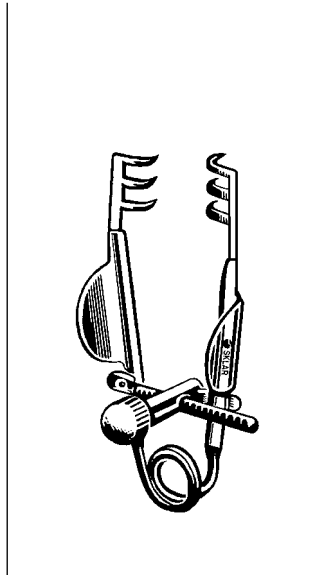


**JEWELLERS STYLE
FORCEPS**

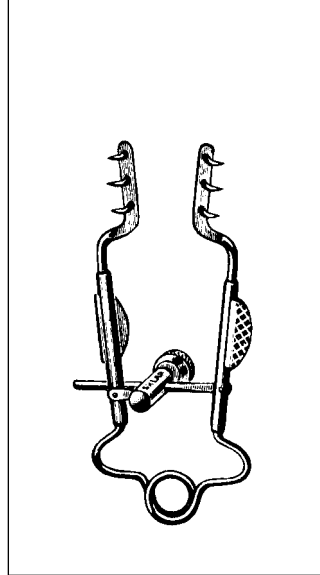
66-7645 #7 Curved



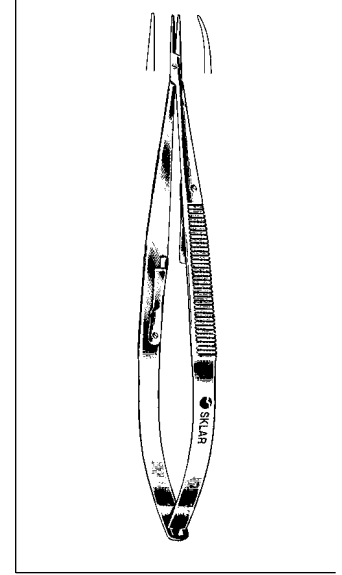
GOLDSTEIN RETRACTOR
47-2913 1 1/2"



SELF-RETAINING DELICATE RETRACTOR
65-1815 1 1/2"

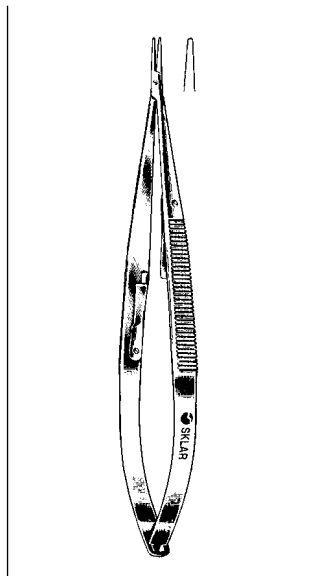


MELLER LACRIMAL SAC RETRACTOR
3 Prong 3 mm Deep
65-1830 3"



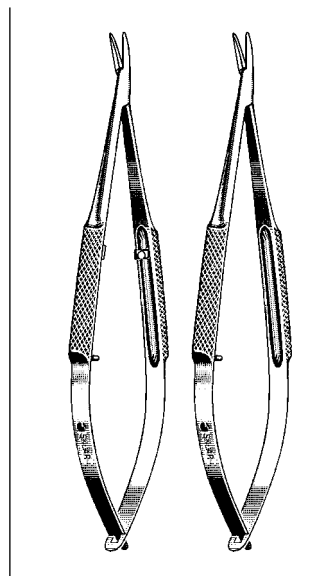
CASTROVIEJO NEEDLE HOLDERS

Standard handle, Extra Delicate, Smooth
Jaws to hold 7-0 Sutures (especially milled handle to improve traction)
65-6350 5/4" Straight jaw without catch
65-6352 5/4" Straight jaw with catch
65-6354 5/4" Curved jaw with catch



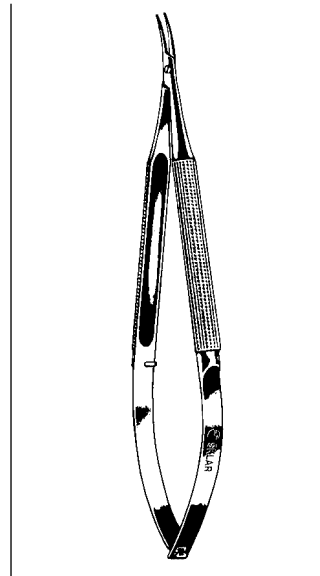
CASTROVIEJO NEEDLE HOLDER

With Catch
65-6357 5/4" Straight
65-6358 5/4" Curved



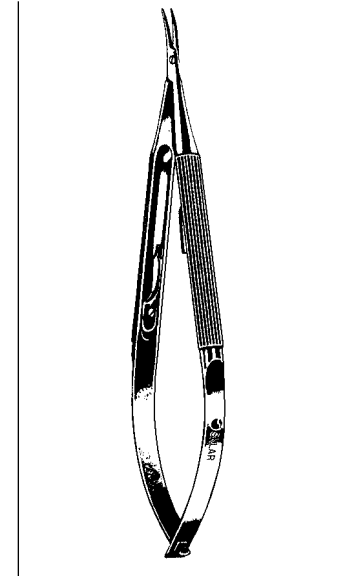
COHAN NEEDLE HOLDER

Mini-micro 7 mm jaws 100 mm
65-6470 Curved without lock
65-6475 Curved with lock



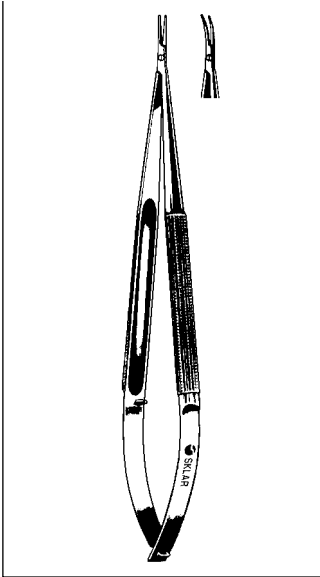
MICRO SURGERY NEEDLE HOLDER

5/4" With Round Handle
98-3180 Curved Jaws



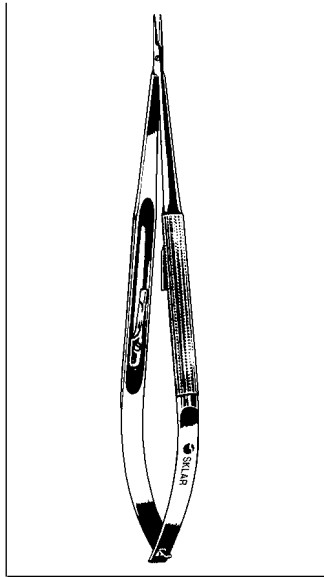
MICRO SURGERY NEEDLE HOLDER

5/4" With Round Handle
98-3182 Curved Jaws with Lock
0.6 mm tips



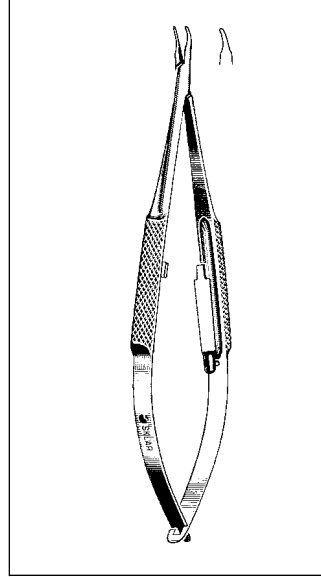
MICRO SURGERY NEEDLE HOLDERS

7 1/8" With Round Handle
 98-3186 Straight Jaws 0.6 mm tips
 98-3188 Curved Jaws 0.6 mm tips



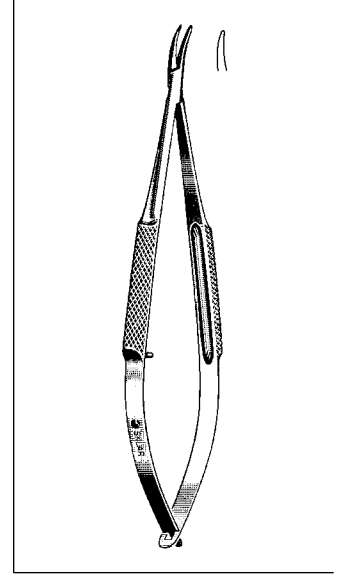
MICRO SURGERY NEEDLE HOLDERS

7 1/8" With Round Handle
 98-3190 Straight Jaws with Lock
 0.6 mm tips
 98-3192 Curved Jaws with Lock
 0.6 mm tips



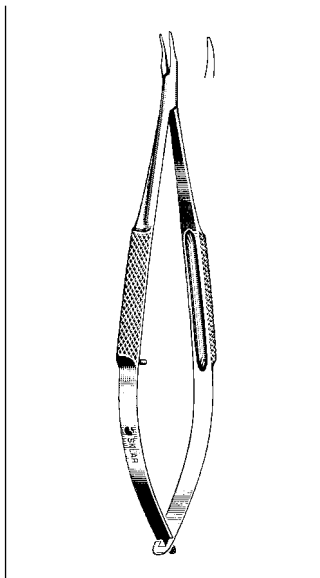
BARRAQUER NEEDLE HOLDERS

Round grip spring handle, with inside catch
 65-6446 5/4" Delicate Curved jaw
 65-6448 5/4" Delicate Smooth jaw



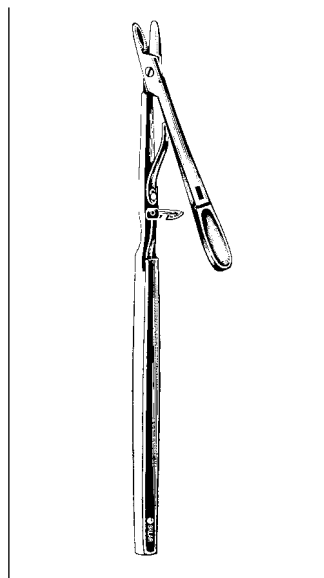
BARRAQUER NEEDLE HOLDER

Delicate curved jaw, round grip spring handle, without catch
 65-6452 5/4"



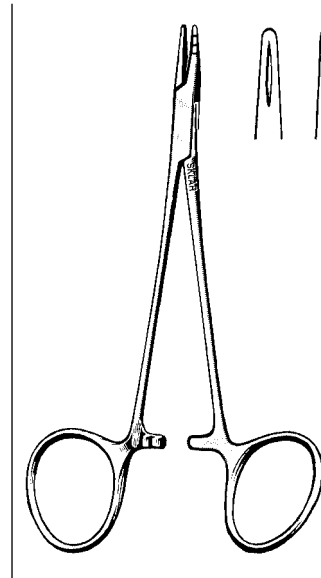
TROUTMAN NEEDLE HOLDER

Extra delicate curved jaw, round grip spring handle
 65-6460 4 3/4" with inside catch
 65-6462 4 3/4" without inside catch



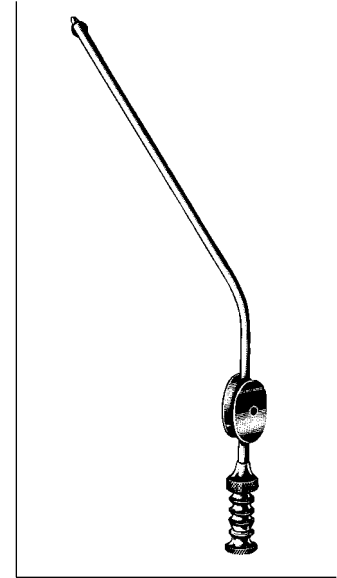
STEVENS NEEDLE HOLDER

65-6265 6 1/2"



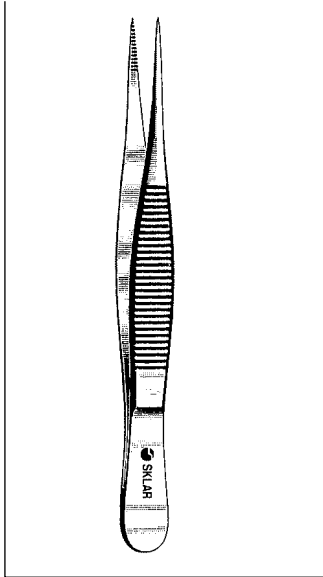
NEIVERT NEEDLE HOLDER

20-1760 5" One offset ring



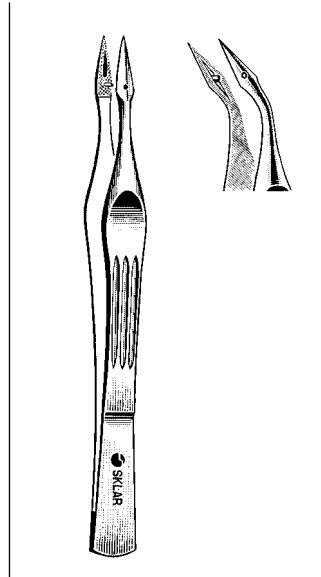
BARON SUCTION TUBES

With combination finger rest and cut-off valve
 50-1959 3 Fr.
 50-1961 5 Fr.
 50-1963 7 Fr.



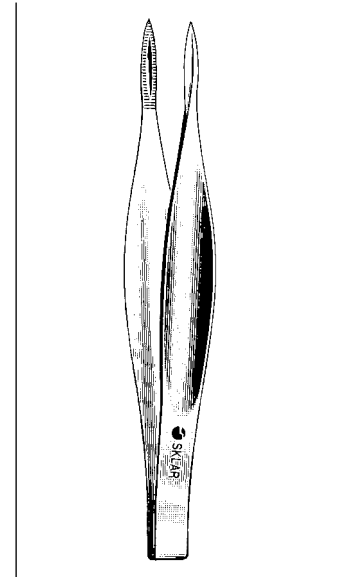
**FINE POINT
SPLINTER FORCEPS**

19-3035 3½"
19-3040 4"
19-3045 4½"



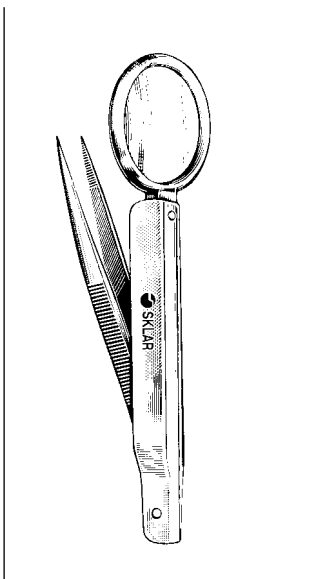
**CARMALT
SPLINTER FORCEPS**

19-3240 4" Straight
19-3340 4" Curved



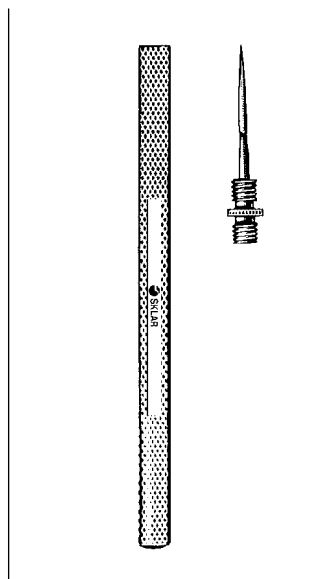
**FEILCHENFELD
SPLINTER FORCEPS**

19-2930 3"
19-2945 4½"



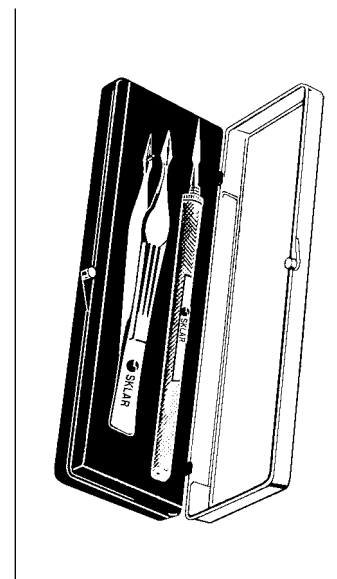
**PLAIN SPLINTER
FORCEPS WITH
MAGNIFIER**

19-3030 3" Non-Autoclavable



**VANGUARD
SPLINTER PICK**

19-3350 Chrome

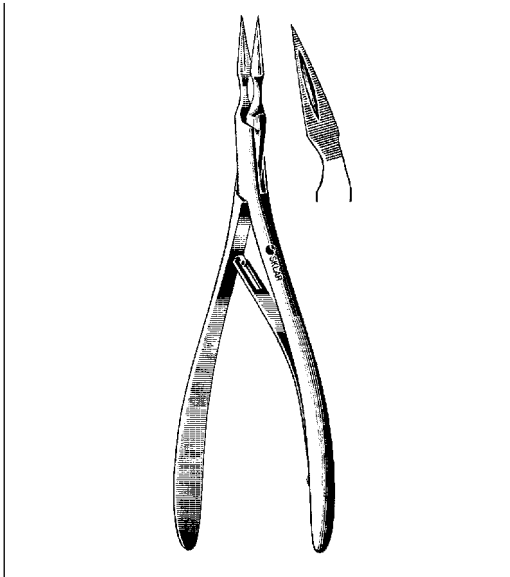


**SKLAR SPLINTER
REMOVAL KIT**

19-3360 Containing one 19-3240 and
one 19-3350 in a convenient
storage case

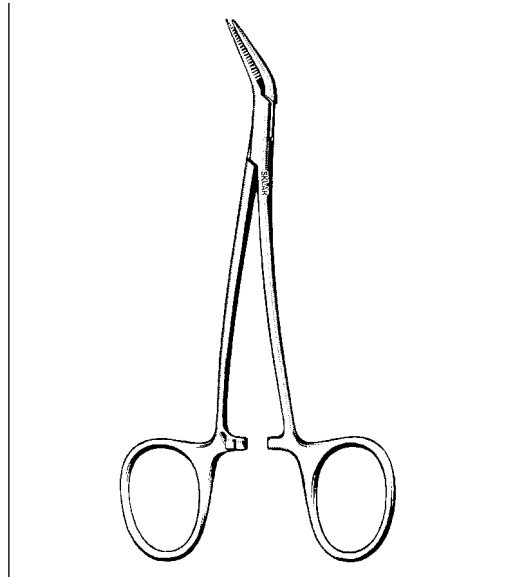
DERMAL INSTRUMENTS

SPLINTER FORCEPS



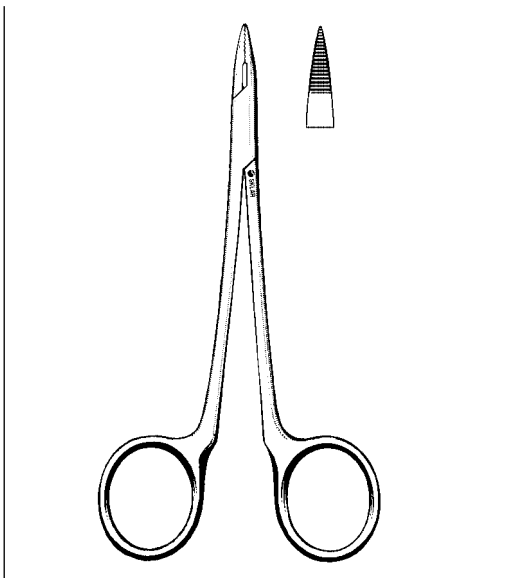
VIRTUS SPLINTER FORCEPS

19-3160 6" Straight
19-3162 6" Angled



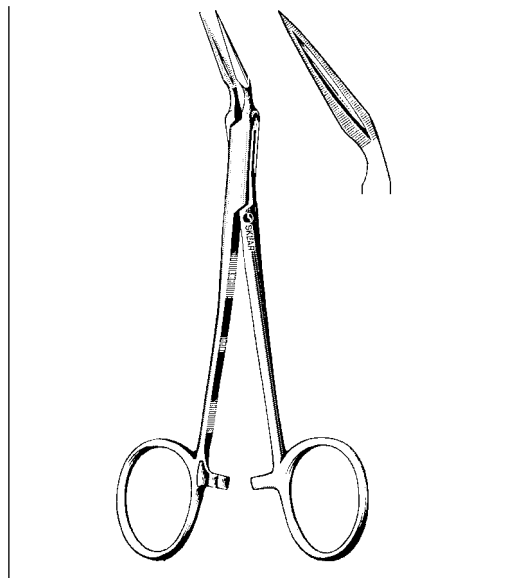
PEET SPLINTER FORCEPS

Double Curve
19-3147 4³/₄" Angular



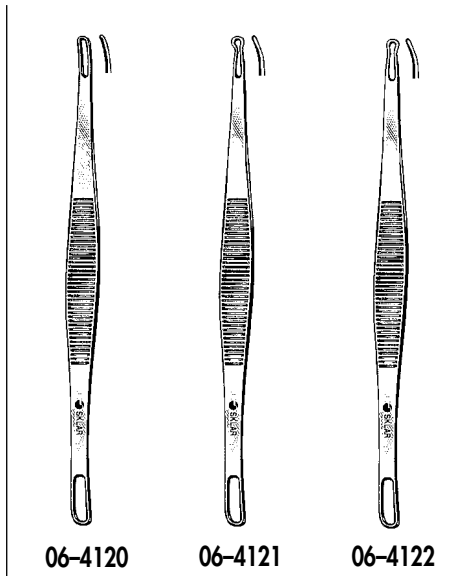
PHYSICIANS SPLINTER FORCEPS

19-3050 5"



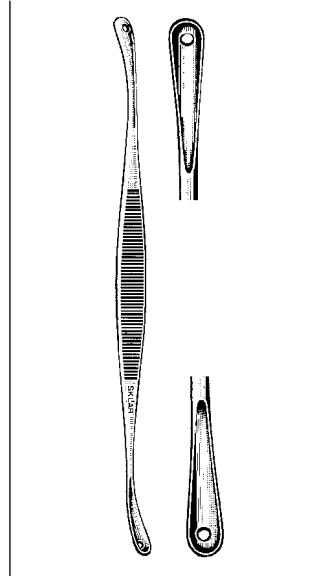
WILLIAMS (STIEGLITZ) SPLINTER FORCEPS

19-3055 5" Angular



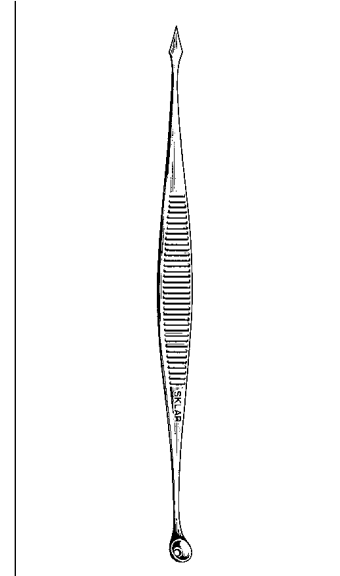
**SCHAMBERG
COMEDONE EXTRACTOR**

- 06-4120 Regular Size
- 06-4121 One End Extra Fine
- 06-4122 Square Ends



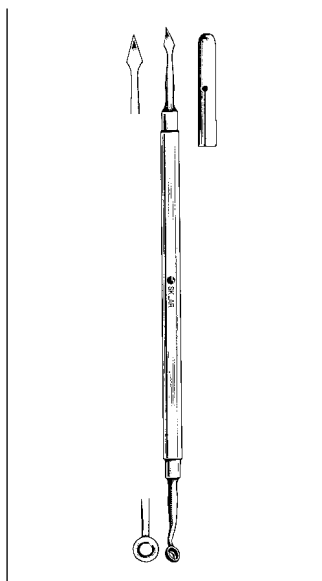
**UNNA COMEDONE
EXTRACTOR**

- 5³/₄" Double End
- 06-4125



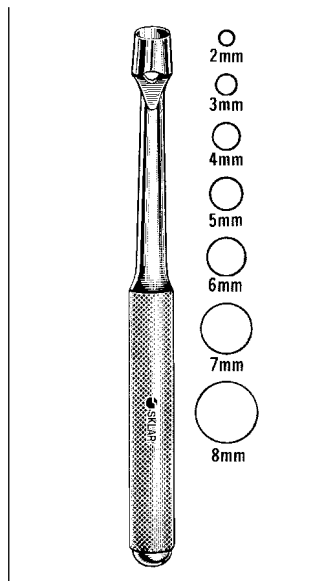
**COMEDONE
EXTRACTOR**

- Spear Point
- 06-4126



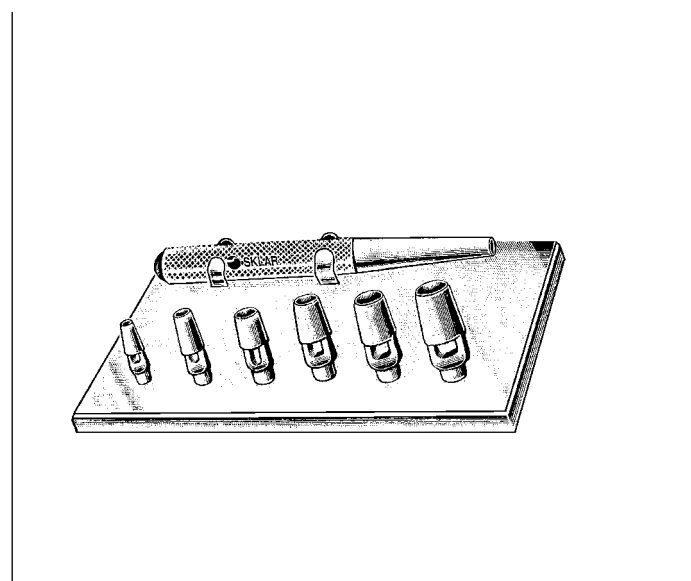
**SKLAR COMEDONE
EXTRACTOR**

- Spear Point with Cover
- 06-4128 Double End Chrome



**KEYES CUTANEOUS
PUNCH 4"**

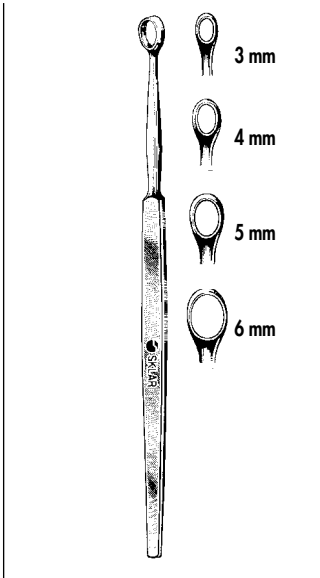
- 06-4142 2 mm
- 06-4143 3 mm
- 06-4144 4 mm
- 06-4145 5 mm
- 06-4146 6 mm
- 06-4147 7 mm
- 06-4148 8 mm



KEYES DERMAL PUNCH SET

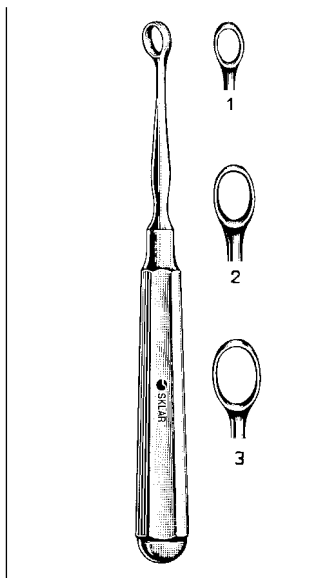
- 06-4100 Complete on Sterilizable Base

DERMAL INSTRUMENTS



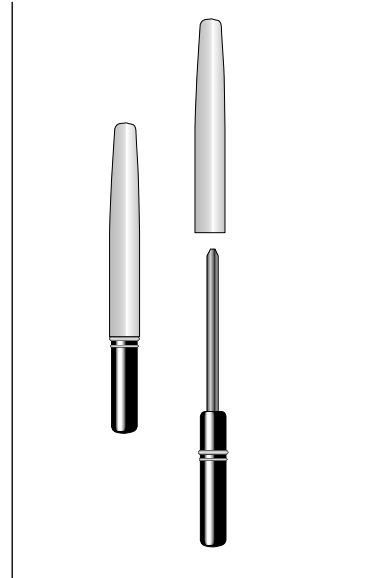
FOX DERMAL CURETTE 5 1/2"

Oval	Round
06-4133 3 mm	06-4138 3 mm
06-4134 4 mm	06-4139 4 mm
06-4135 5 mm	06-4140 5 mm
06-4136 6 mm	06-4141 6 mm



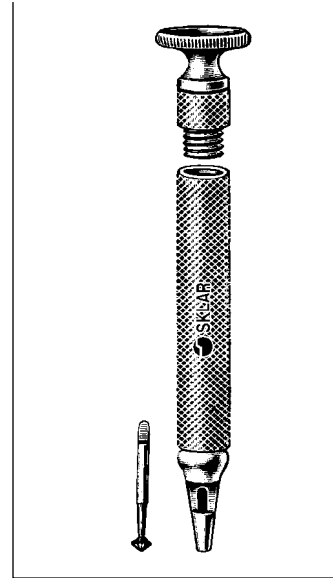
PIFFARD DERMAL CURETTE

Oval
06-4130 #1
06-4131 #2
06-4132 #3



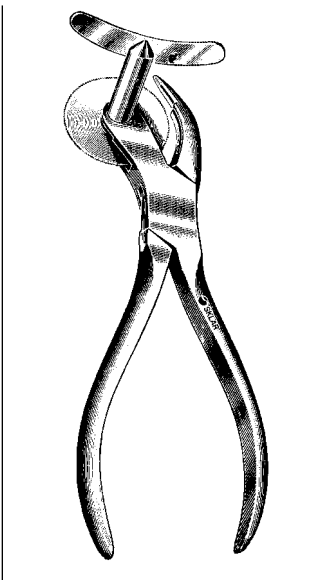
SHARPENING STONE

06-4110 For Keyes Dermal Punches



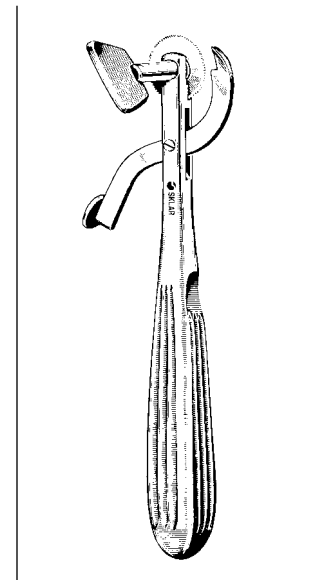
SKLAR FINGER NAIL DRILL

06-4160 Three Drill Points
Nestled in Handle
06-4161 Set of Three Drill Points Only



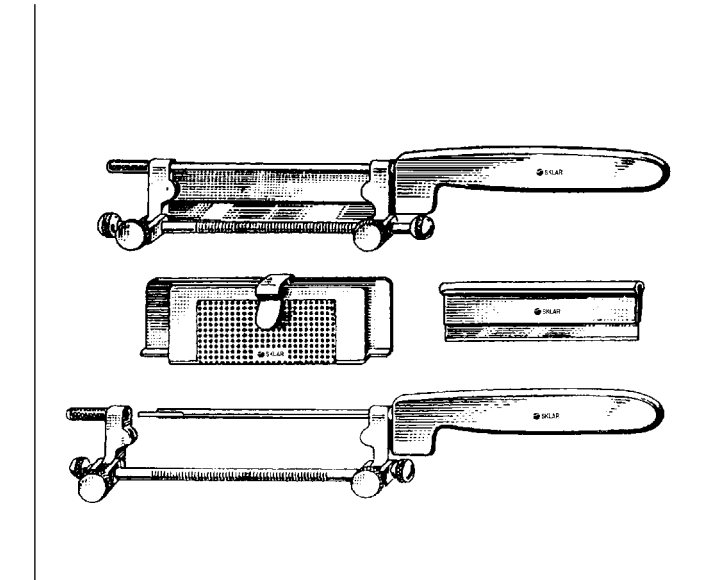
KEYES FINGER RING CUTTER

Stainless Steel
06-4150 Ring Cutter Complete
06-4151 Blades w/Brass Bushings
Attached for above ring cutter
06-4157 Blades w/Removable
Chrome Bushings



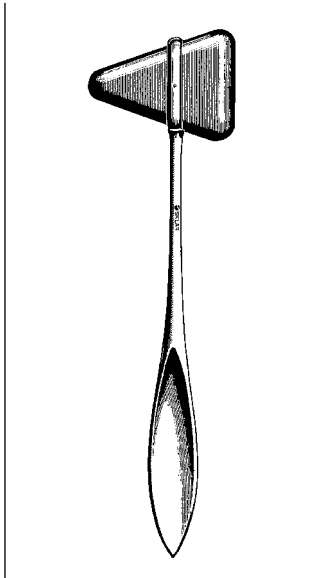
SKLAR FINGER RING CUTTER-CHROME

06-4152 6"
06-4153 Blade for Sklar Finger
Ring Cutter



POTTER BODENHAM HUMBY SKIN GRAFTING KNIFE

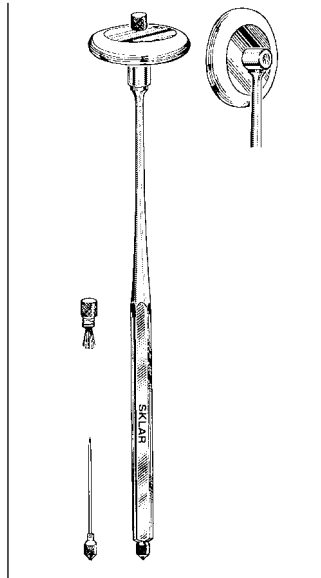
Miniature Size Detachable Roller
41-1500 Two replacement blades and perforated metal guard.



TAYLOR PERCUSSION HAMMER

Solid Handle

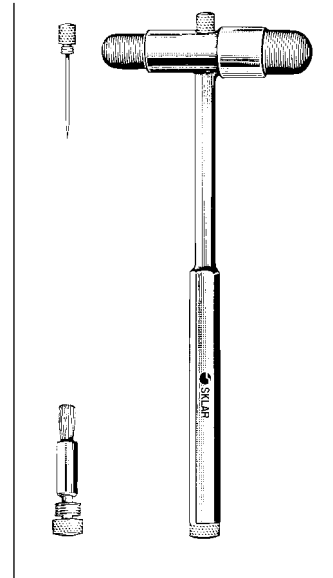
06-3170 Small 7"
06-3175 Large 7½"



RABINER NEUROLOGICAL HAMMER

With Pin and Brush

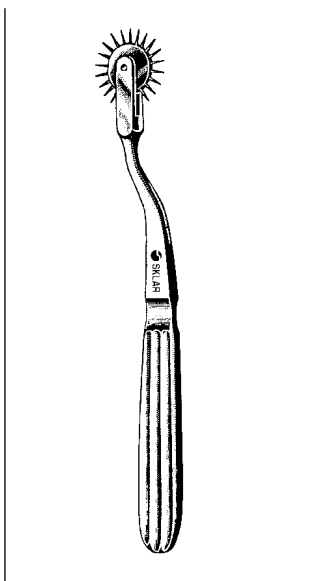
06-3290 Chrome



BUCK NEUROLOGICAL HAMMER

With Pin and Brush

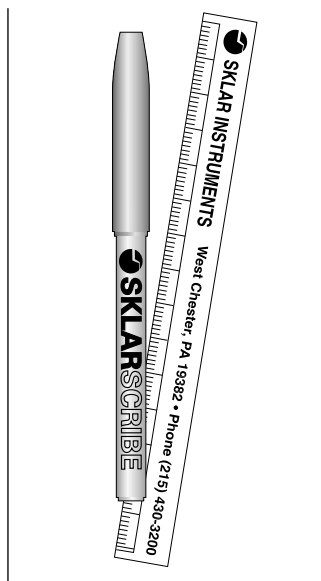
06-3370 Chrome



WARTENBERG NEUROLOGICAL PINWHEEL

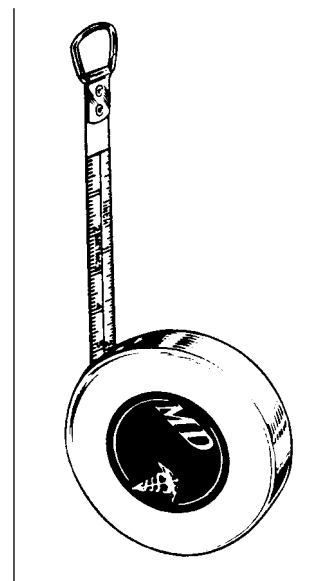
Chrome Plated

06-3375



SKLAR SCRIBE SKIN MARKER

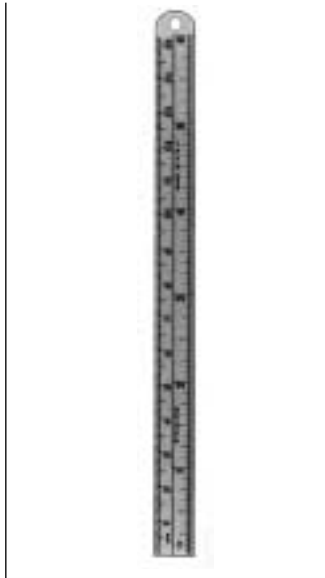
10-1641 Pack of 10
10-1640 Case of 100



TAPE MEASURE RETRACTABLE

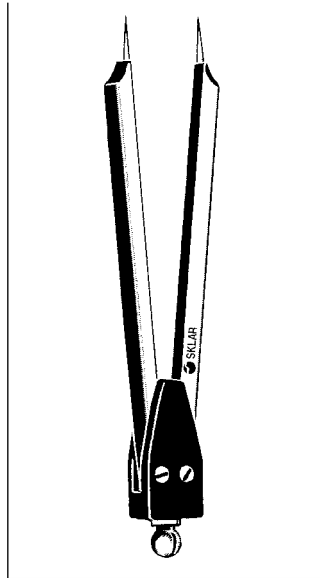
MD Scale

06-2852



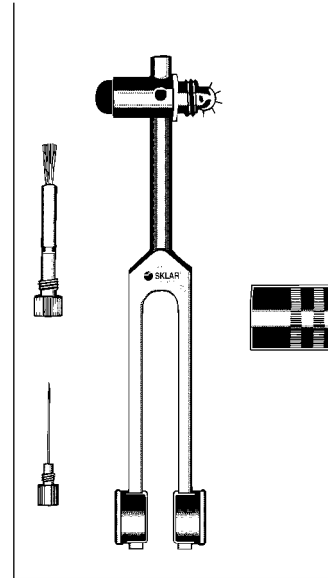
METAL RULER

06-2860 6"
06-2861 12"



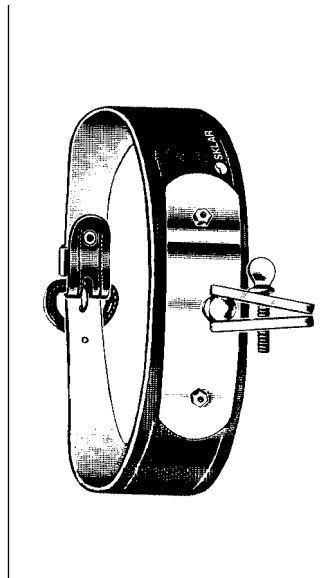
EKG CALIPER

06-2808 7" Chrome



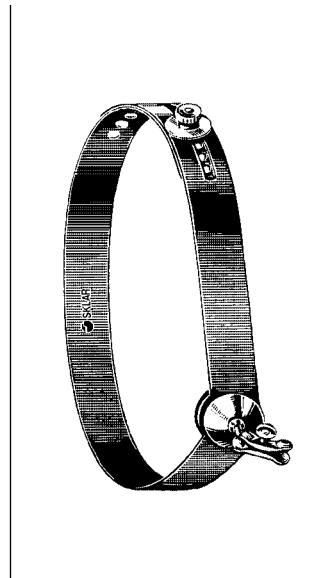
FIVE-IN-ONE TUNING FORK

06-2865 128 Cycle



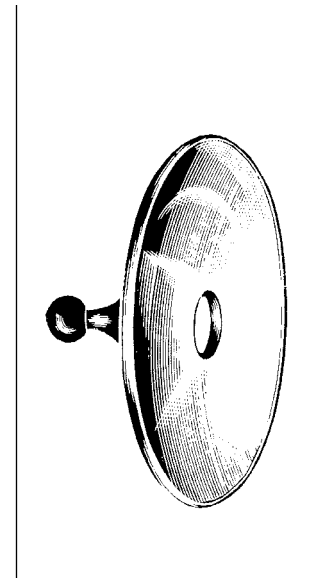
JEFFERSON LEATHER HEADBAND

73-1015 1 1/2" With Pad



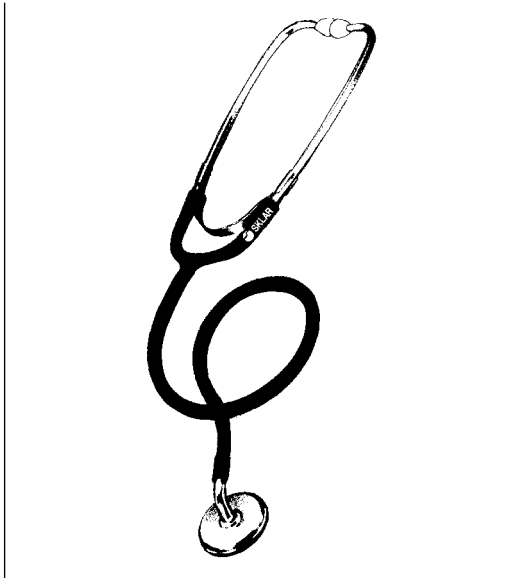
SKLAR POLYETHYLENE HEADBAND

73-1082



HEAD MIRROR

Boilable
73-1085 3 1/2" Diameter 1/2" Hole
73-1086 3" with Stainless Back



PHYSICIAN'S STETHOSCOPE LIGHTWEIGHT

With Vinyl Pouch

06-1000 Bowles

06-2631 Binaural-Lite Weight w/Mushroom Tip



PHYSICIAN'S STETHOSCOPE

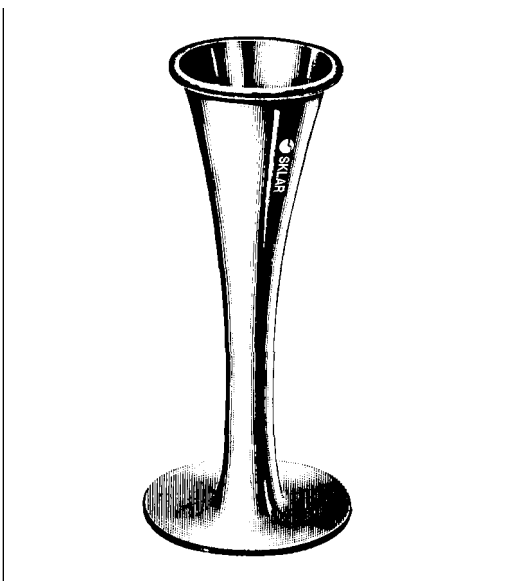
Standard Model-Bowles

06-1003 1³/₄"

06-2502 Chest Piece Only

06-2503 Diaphragm Only

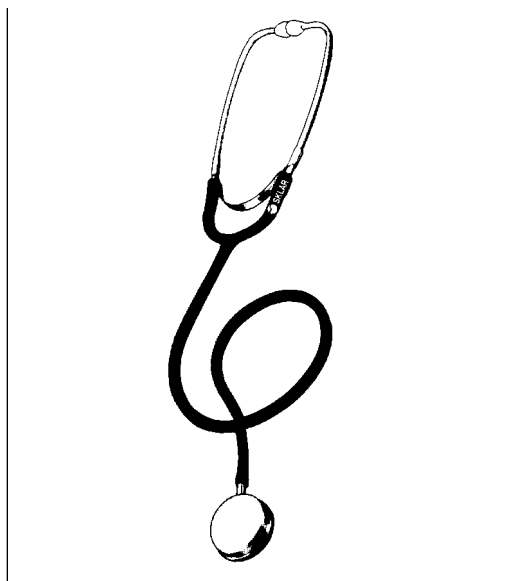
06-2629 Binaural w/Plastic Ear Tips



PINARD STETHOSCOPE FOR FETAL HEART

Aluminum

06-1101



NURSE'S STETHOSCOPE LIGHTWEIGHT

With Vinyl Pouch

06-1004

06-2606 Standard Soft Rubber Ear Tips/Pair

06-2607 Standard Plastic Ear Tips/Pair

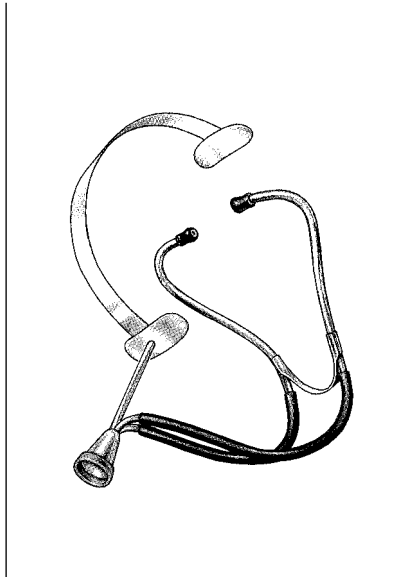
DIAGNOSTIC INSTRUMENTS



LEFF STETHOSCOPE FOR FETAL HEART

With Weighted Bell and Small Bell

- 06-1201 Chrome Plated
- 06-1202 With Weighted Bell Only
- 06-1210 Double/Teaching Stethoscope



DELEE-HILLIS OBSTETRICAL STETHOSCOPE

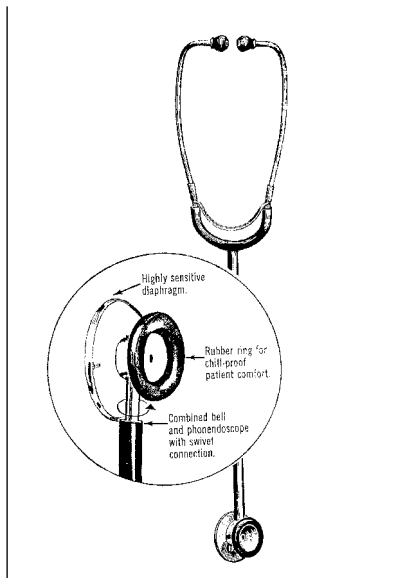
Metal Headband and Rigid Shank

- 06-1301 Chrome Plated



PERELL FETOSCOPE

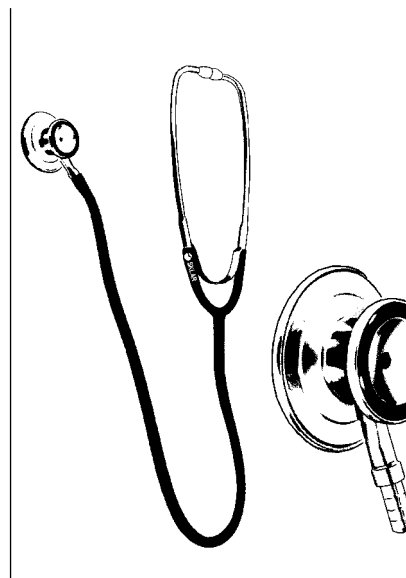
06-1701 With Slip on Tubing Adaptor



MAGNATONE STETHOSCOPE

Non-Chill Chest Piece

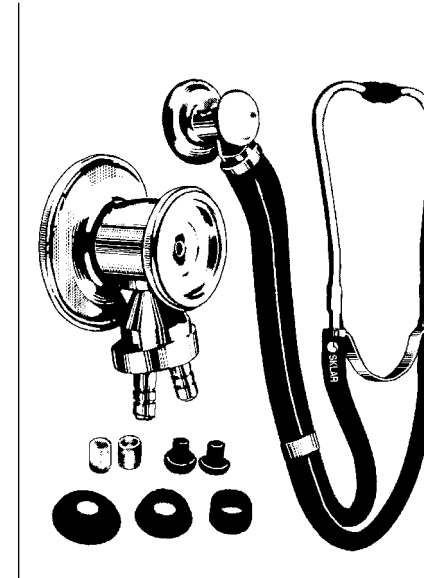
- 06-1801 Lightweight



SONOSCOPE, ADULT

Dual Chestpiece

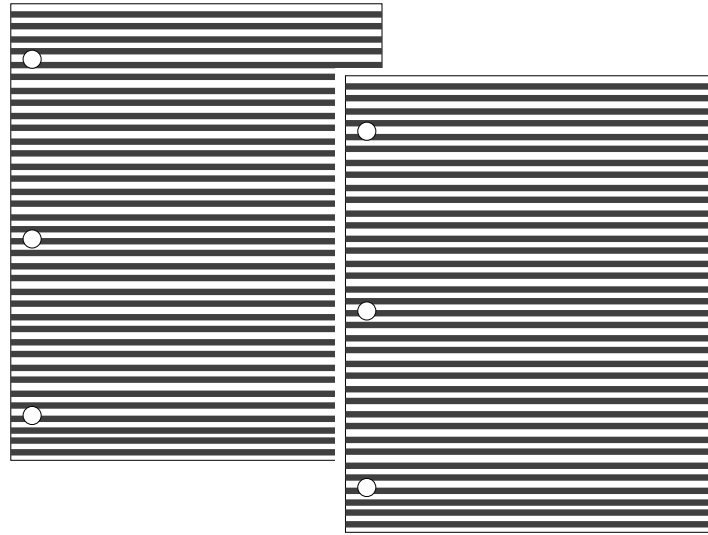
- 06-1901 Blue Tubing
- 06-1906 Black Tubing



SPRAGUE-RAPPAPORT STETHOSCOPE

Complete with 5 Chestpieces and Large & Small Earpieces

- 06-1935 Complete



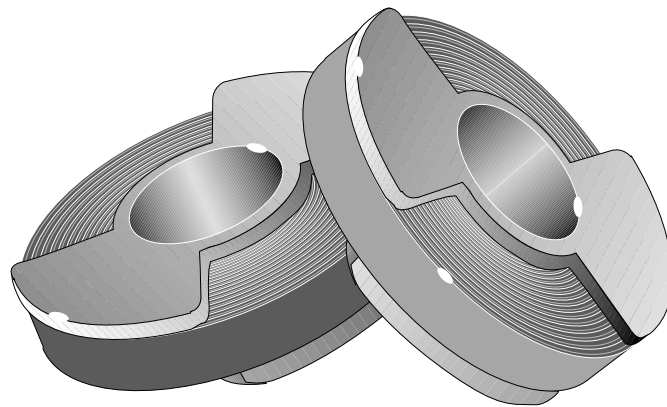
Autoclavable

SKLAR ID SHEET TAPE

9 Colors with White Stripes

96-1845	Dark Blue w/White Stripes	96-1850	Brown w/White Stripes
96-1846	Dark Green w/White Stripes	96-1851	Lavender w/White Stripes
96-1847	Red w/White Stripes	96-1852	Light Blue w/White Stripes
96-1848	Yellow w/White Stripes	96-1853	Pink w/White Stripes
96-1849	Orange w/White Stripes		

Color coding is convenient with Sklar ID Sheet Tape. There are many combinations of tapes fixed to an easily removed backing. Each 8½" x 11" Sheet contains 374' of tape. Lasts through many autoclaving and gas sterilizing procedures.



Autoclavable

SKLAR ID ROLL TAPE

10 Colors Available

96-1860	White	96-1872	Blue
96-1862	Green	96-1874	Red
96-1864	Yellow	96-1876	Brown
96-1866	Orange	96-1878	Bright Orange
96-1868	Black		
96-1870	Purple		

Sklar ID Roll Tape is a convenient color coding tape to make instruments easily recognized. It's autoclavable, available in 10 colors. Each roll contains 300' and is ¼" wide. Lasts through many autoclaving and gas sterilizing procedures.

INSTRUMENT IDENTIFICATION & PROTECTORS



Box of 100 96-1400 Maroon
11.0 mm
 $\frac{1}{32}$ " x $\frac{3}{4}$ "

*Now Available
New Laparoscopic
Tip Protectors
Call For Information*

Box of 100 96-1402 Yellow
6.0 mm
 $\frac{3}{16}$ " x 1"

Box of 100 96-1410 White
1.5 mm
 $\frac{1}{16}$ " x $\frac{3}{4}$ "

Box of 100 96-1404 Red
4.0 mm
 $\frac{1}{8}$ " x 1"

Box of 100 96-1412 Black
25 X 3.0 mm
 $\frac{1}{8}$ " x 1" x 1"

Box of 100 96-1406 Green
3.0 mm
 $\frac{7}{64}$ " x $\frac{3}{4}$ "

Box of 100 96-1414 Brown
18 X 3.0 mm
 $\frac{5}{64}$ " x $\frac{5}{8}$ " x 1"

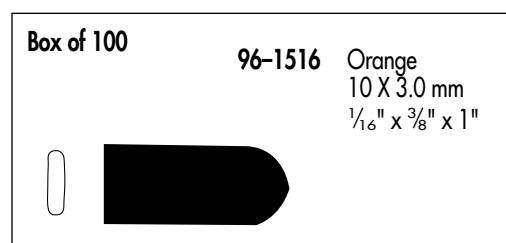
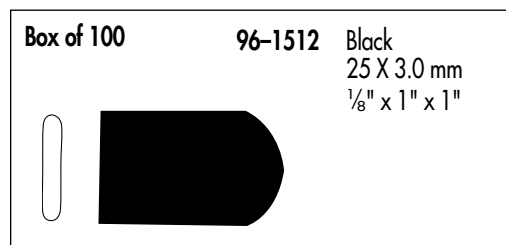
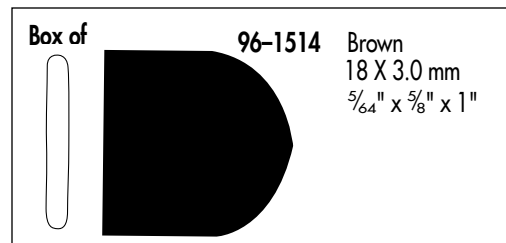
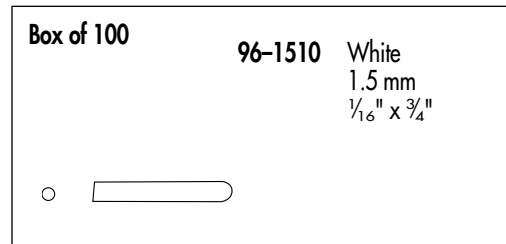
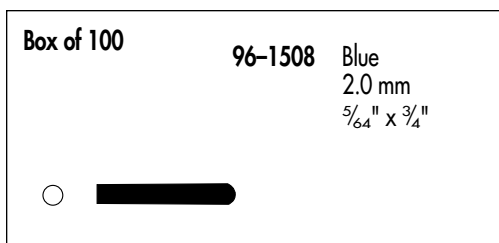
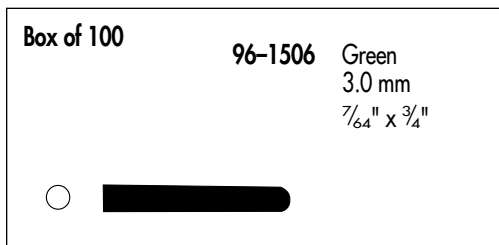
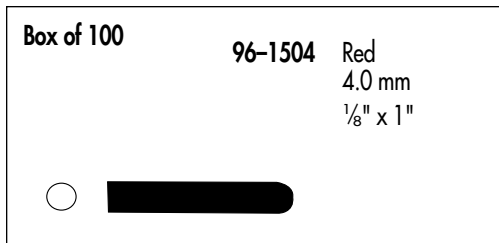
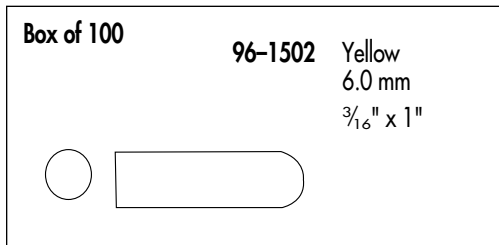
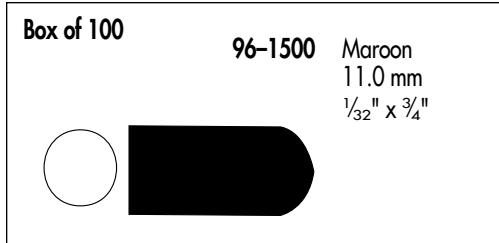
Box of 100 96-1408 Blue
2.0 mm
 $\frac{5}{64}$ " x $\frac{3}{4}$ "

Box of 100 96-1416 Orange
10 X 3.0 mm
 $\frac{1}{16}$ " x $\frac{3}{8}$ " x 1"

VENTED SKLARGUARD TIP PROTECTORS

SklarGuard Instrument Guards are a convenient, color-coded way to protect surgical instrument tips and edges. SklarGuard instrument guards provide exceptional protection, as they are steam permeable, autoclavable, and stretch to fit a wide variety of instrument shapes and sizes.

Box of 100—Color Coded Sizes

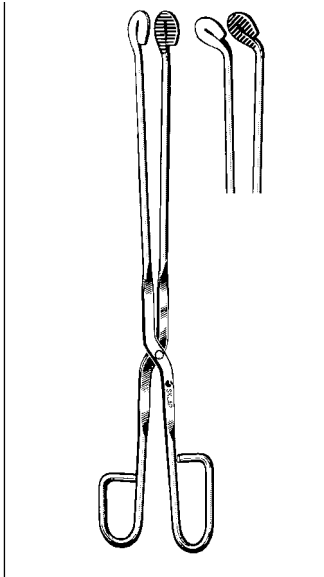


NON-VENTED SKLARGUARD TIP PROTECTORS

SklarGuard Instrument Guards are a convenient, color-coded way to protect surgical instrument tips and edges. SklarGuard instrument guards provide exceptional protection, as they are steam permeable, autoclavable, and stretch to fit a wide variety of instrument shapes and sizes.

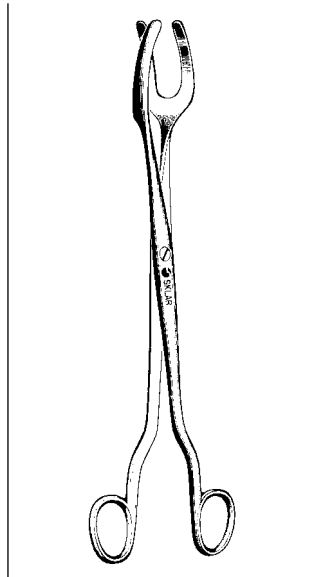
Box of 100—Color Coded Sizes

CLEANING & STERILIZING PRODUCTS



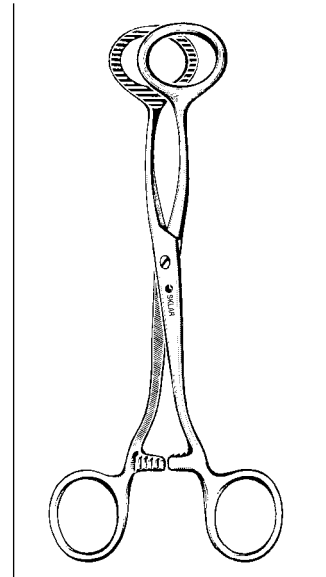
STERILIZER FORCEPS

10-1080	8"	Straight
10-1111	11"	Straight
10-1180	8"	Curved
10-1211	11"	Curved



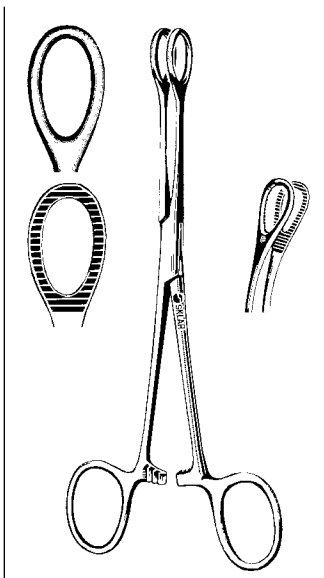
STERILIZER FORCEPS

10-1280	8"	3 prongs
10-1312	12"	3 prongs



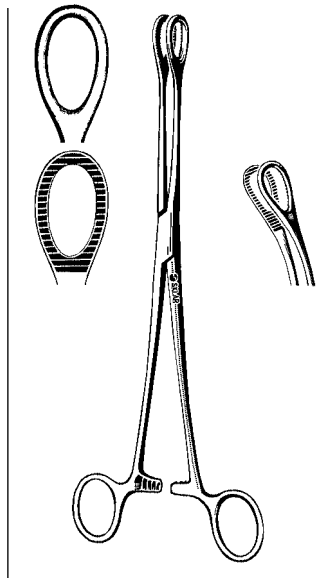
COLLINS TONGUE SEIZING FORCEPS

07-1565	6½"
07-1570	7"



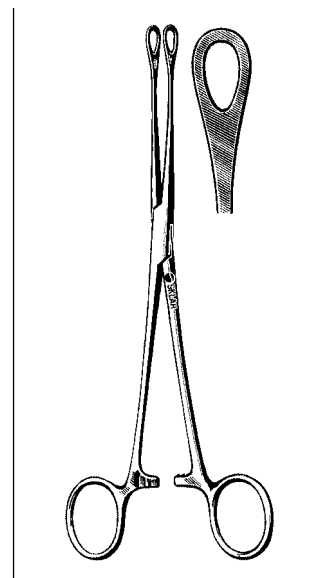
BALLENGER SPONGE FORCEPS

Straight		
74-1370	7"	Smooth
74-1470	7"	Serrated
Curved		
74-1670	7"	Serrated



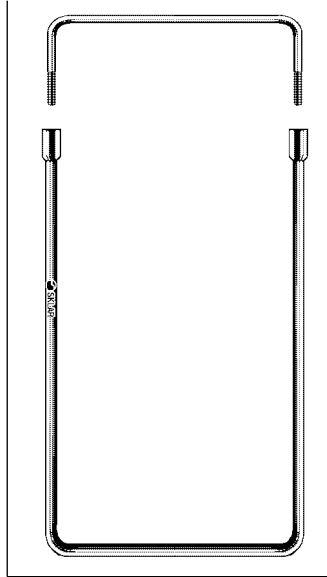
FOERSTER SPONGE FORCEPS

Straight		
87-2095	9½"	Smooth
87-2195	9½"	Serrated
Curved		
87-2395	9½"	Serrated



PEANUT SPONGE FORCEPS

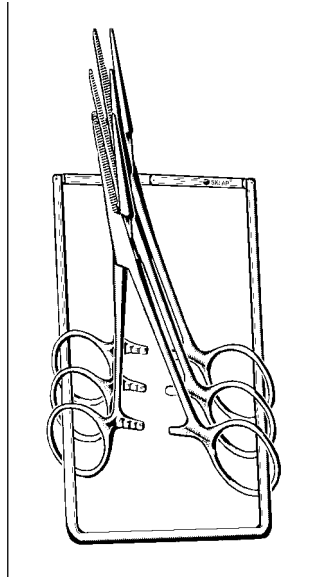
22-9380	8"	Smooth	Straight
22-9480	8"	Serrated	Curved



WEINSTEIN INSTRUMENT RACK

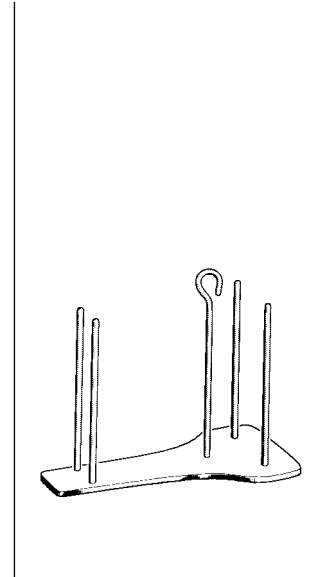
For Sterilizing Ring Handle Instruments

- 10-1800 5 1/2" x 3"
- 10-1805 11 1/4" x 3"



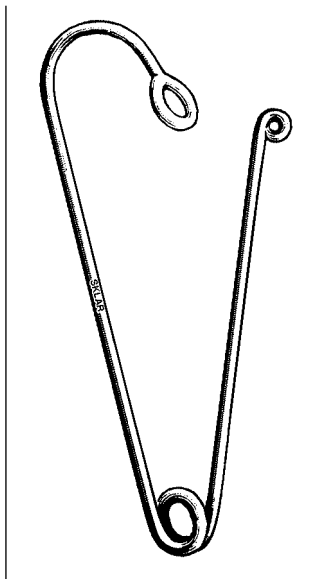
INSTRUMENT STRINGERS

2 1/2" Wide		5" Wide	
10-1808	8"	10-1828	8"
10-1810	10"	10-1830	10"
10-1812	12"	10-1832	12"
10-1816	16"	10-1836	16"
10-1818	18"	10-1838	18"



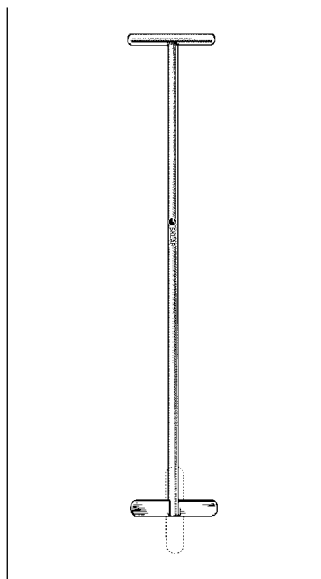
SKLAR FORCEPS HOLDER

With Lifting Hook
10-1765



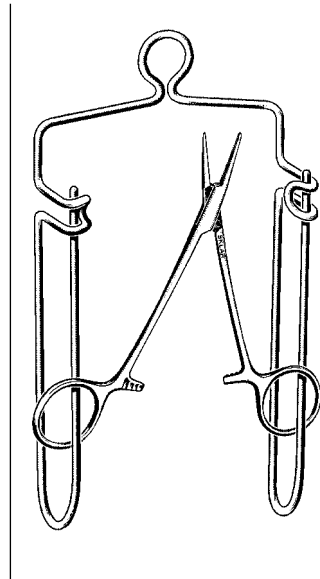
BUNT INSTRUMENT HOLDER

10-1770



WEISENBACH FORCEPS HOLDER

- 10-1775 6"
- 10-1776 12"



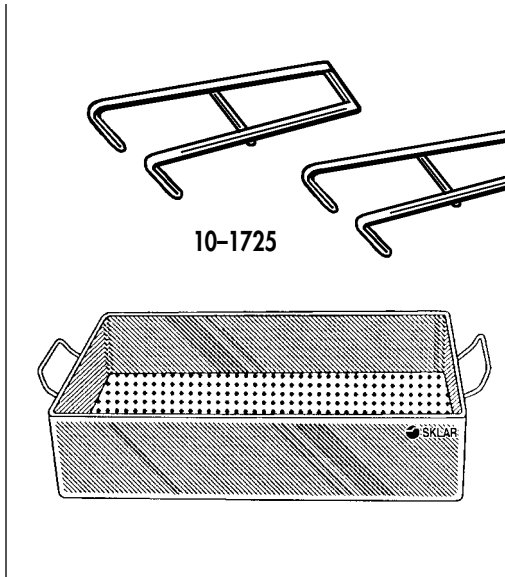
SAUNDERS INSTRUMENT RACK

10-1780



ALLIGATOR NAPKIN CLIPS

- 06-6209 With Plastic Guard
- 06-6208 Plain

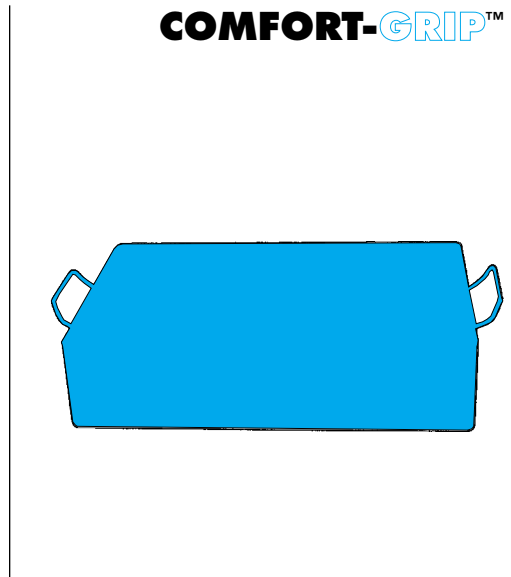


10-1725

INSTRUMENT STERILIZING TRAY

With Loop Handles—Outside Dimensions

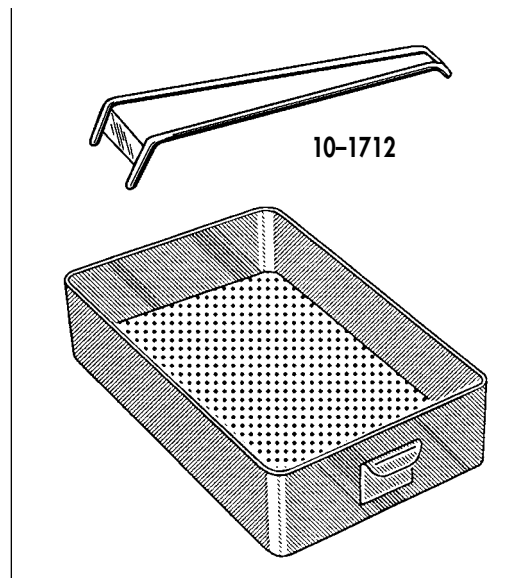
- 10-1705 6 3/8" x 3 3/8" x 1 1/4"
- 10-1710 10" x 6 1/2" x 2 1/2"
- 10-1714 15" x 10 1/2" x 3 1/2"
- 10-1720 20" x 10" x 3"
- 10-1725 Handles for Lifting Sold in Pairs



COMFORT GRIP™ INSTRUMENT STERILIZING TRAY

With Loop Handles—Outside Dimensions

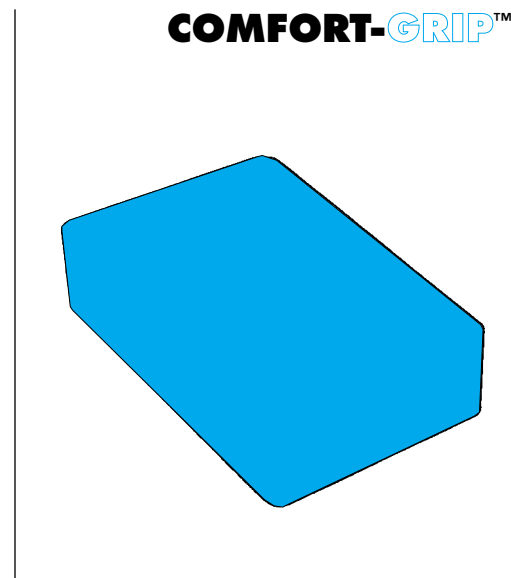
- 94-1705 6 3/8" x 3 3/8" x 1 1/4"
- 94-1710 10" x 6 1/2" x 2 1/2"
- 94-1714 15" x 10 1/2" x 3 1/2"
- 94-1720 20" x 10" x 3"
- 94-1725 Handles for Lifting Sold in Pairs



10-1712

FLASH STERILIZATION INSTRUMENT TRAY

- 10-1711 10" x 6 1/2" x 2"
- 10-1712 Handle Only



COMFORT GRIP™ FLASH STERILIZATION INSTRUMENT TRAY

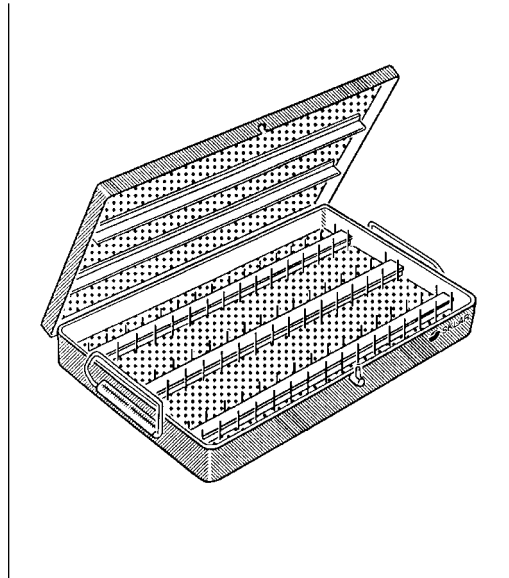
- 94-1711 10" x 6 1/2" x 2"
- 94-1712 Handle Only



CLEANING BASKET

Folding Handles

- 10-1729 4 1/4" x 7 1/4" x 2"
- 10-1731 6" x 9" x 3"
- 10-1732 8 1/2" x 12 1/2" x 3 1/2"
- 10-1733 9 1/2" x 16" x 4"
- 10-1734 12" x 21" x 5"
- 10-1736 14" x 20" x 5"



MICRO-INSTRUMENT STERILIZING TRAY

- 10-1700 8 1/2" x 8" x 1 1/4"
- 10-1707 8 1/2" x 12" x 1 1/4"
- 10-1708 8" x 14" x 1 1/4"
- 10-1701 10" x 6 1/2" x 3/4"
- 10-1702 10 1/2" x 10" x 1 1/2"
- 10-1703 15" x 10 1/2" x 1 1/4"



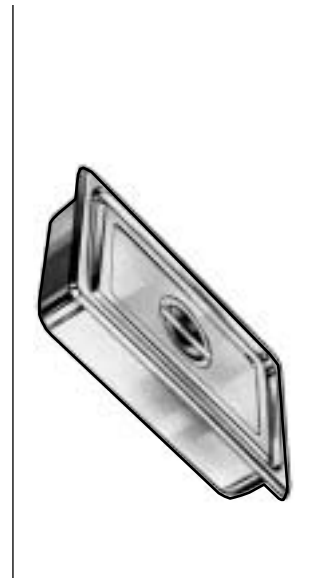
MICRO-INSTRUMENT STERILIZING TRAY

- 10-1706 8 1/2" x 8" x 1 1/4" with 2 1/2" x 2 1/2" Compartment
- 10-1716 10 1/2" x 20" x 2 1/2" with 10 1/2" x 5" Compartment



DOUBLE DECK MICRO TRAY

- 10-1717 10" x 15" x 2 1/4"



STERILIZING PANS & COVERS

- 10-1850 Solid 12 3/4" x 10 1/2" x 2 1/2"
- 10-1852 Perf 12 3/4" x 10 1/2" x 2 1/2"
- 10-1860 Solid 12 3/4" x 10 1/2" x 4"
- 10-1862 Perf 12 3/4" x 10 1/2" x 4"
- 10-1864 Cover for All Above

CLEANING & STERILIZING PRODUCTS



MAYO TRAY

Perforated

10-1684	10" x 6½" x ¾"
10-1685	13½" x 9¾" x ¾"
10-1686	15" x 10⅝" x ¾"
10-1687	17" x 11⅝" x ¾"
10-1688	19" x 12⅝" x ¾"

MAYO TRAY

Non-Perforated

10-1690	10" x 6½" x ¾"
10-1691	13½" x 9¾" x ¾"
10-1692	15" x 10⅝" x ¾"
10-1693	17" x 10⅝" x ¾"
10-1694	19" x 12⅝" x ¾"



PLASTIC PROCEDURE TRAYS

Reusable and Autoclavable

Can be used as Mayo tray, Floor Tray, Custom Tray and Procedure Tray. Reusable. Textured surface will not rust.

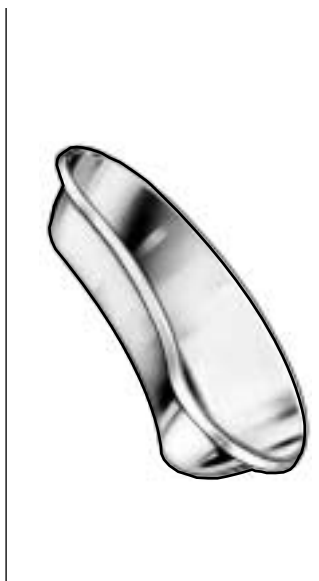
Perforated

10-1965	Mini	10⅞" x 6⅝"	Blue
10-1966	Small	10⅞" x 13⅞"	Blue
10-1967	Medium	11¾" x 16"	Blue



MEDICINE CUP

10-1675 2 oz Graduated



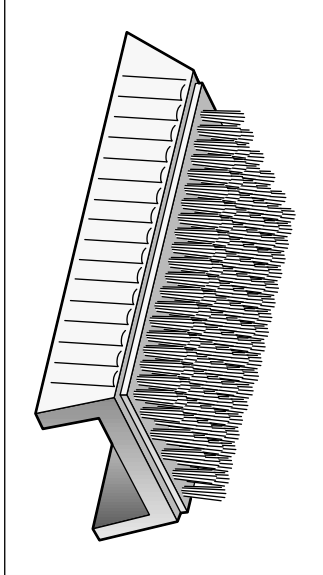
KIDNEY BASIN

10-1698 13 oz
10-1699 26 oz



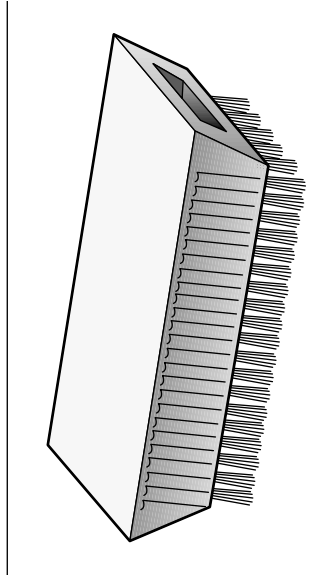
IODINE CUP

10-1670 6 Oz 3⅞" x 2"
10-1671 14 Oz 4⅞" x 2⅞"



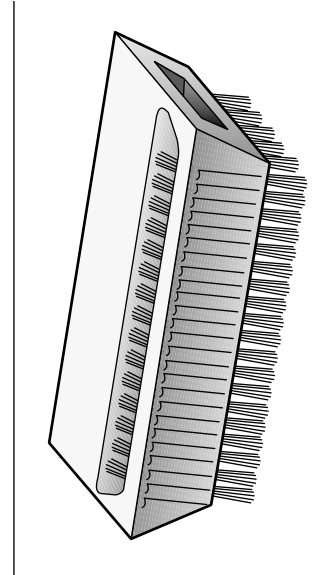
SURGEONS BRUSH

06-2880 Channel Back
06-2870 Pack of 12



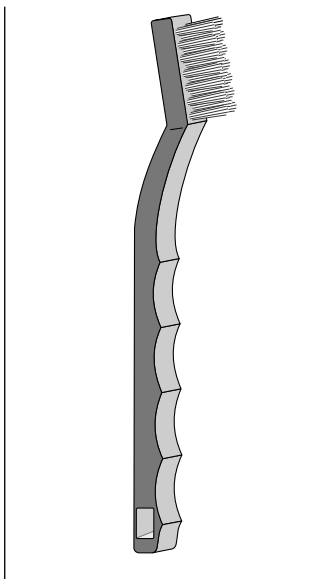
SURGEONS BRUSH

06-2881 Standard
06-2872 Pack of 12



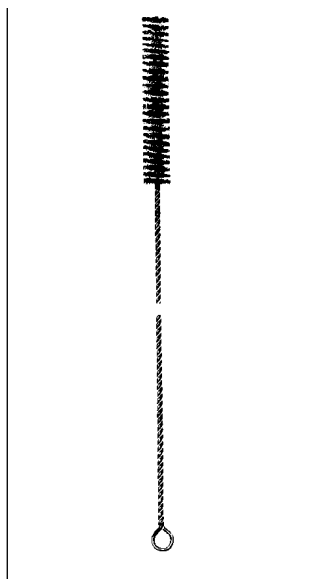
SURGEONS BRUSH

06-2882 With Nail Scrubber
06-2873 Pack of 12



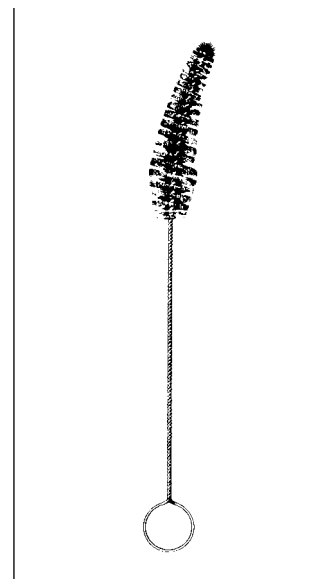
INSTRUMENT CLEANING BRUSH

10-1650	Stainless Steel Bristles	Pack of 3
10-1651	Nylon Bristles	Pack of 3
10-1652	Stainless Steel Bristles	Pack of 12
10-1657	Nylon Bristles	Pack of 12
10-1658	Stainless Steel Bristles	Pack of 24
10-1659	Nylon Bristles	Pack of 24



INSTRUMENT CLEANING BRUSHES - BRISTLE END

10-1660	2 1/4" x 1/8" x 12" Long	Pack of 3
10-1661	2 1/4" x 1/8" x 12" Long	Pack of 12
10-1663	2 1/4" x 1/8" x 12" Long	Pack of 24
10-1664	2 1/2" x 3/8" x 15 1/2" Long	Pack of 3
10-1665	2 1/2" x 3/8" x 15 1/2" Long	Pack of 12
10-1666	2 1/2" x 3/8" x 15 1/2" Long	Pack of 24
10-1668	3 1/2" x 1 x 15 1/2" Long	Pack of 3
10-1669	3 1/2" x 1 x 15 1/2" Long	Pack of 12
10-1672	3 1/2" x 1 x 15 1/2" Long	Pack of 24



CLEANING BRUSH

78-2821	Small 6" Long-1/2" Dia.
78-2822	Med. 7" Long-3/8" Dia.
78-2823	Large 7 1/2" Long-3/4" Dia.
78-2813	Package of 3: Small, Medium, Large

Physicians' Office Safe Instrument Cleaning **AS EASY AS ABC!**

A. **Disinfecting— SKLAR SOAK™**



The use of SKLAR SOAK™ for 10 minutes substantially reduces the risk of exposure to many infectious organisms including TB, and viruses including HIV-1 (Aids Virus), bacteria and fungi. Pre-cleaning and disinfecting soiled instruments in one step prior to handling is safer and more efficient. The formula includes a proprietary series of surfactants, solvents and sequestering agents that combine synergistically to quickly break down protein and penetrate the target organisms. Environmentally friendly, SKLAR SOAK™ exceeds all OSHA standards and is an EPA registered disinfectant. SKLAR SOAK™ contains no dangerous phenols that require skin, eye or respiratory protection and is approved for stainless steel instruments, plastic, chrome, rubber, and glass. The unique combination of ingredients speeds the cleaning process.

B. **Cleaning— SKLAR KLEEN™**



SKLAR KLEEN™ is specially formulated for both manual and ultrasonic cleaners; and is safe for metals, plastic, glassware and rubber. Available as a liquid and in powdered form, the superior wetting power of SKLAR KLEEN™ penetrates crevices to lift away organic debris.

SKLAR KLEEN LF™ (Low Foam) is designed for use in mechanical washers, disperses quickly, and is well suited for automatic injection systems. SKLAR KLEEN LF™ is available in liquid form and is an especially effective and economical liquid cleaner for surgical instruments and laboratory glassware.

When hand processing instruments heavily laden with gross organic debris, the use of SKLAR ENZYMATIC™ cleaner is recommended prior to disinfecting. Otherwise a SKLAR Instrument Brush is used to remove residual material.

C. **Lubrication— SKLAR LUBE™**

*(Not recommended with
dry heat)*



Regular use of SKLAR LUBE™ in your cleaning regimen will help extend the life of surgical instruments. It's concentrated! One gallon makes 5 gallons of lubricant. Simply immerse entire instrument in SKLAR LUBE™, no need to concentrate only on moving parts. SKLAR LUBE™ is a water soluble, non-oil based and non-silicone solution. Its effective formula keeps instruments looking and operating like new. Instruments go directly from SKLAR LUBE™ to the autoclave without rinsing or wiping.

D. **STERILIZE**

SKLAR recommends autoclaving.

Step A. Sklar Soak™ Disinfectant

The use of SKLAR SOAK™ for 10 minutes substantially reduces the risk of exposure to many infectious organisms including TB, and viruses such as HIV-1 (Aids Virus), bacteria and fungi.

- Glutaraldehyde-Free!
- Non-caustic formula.
- Effective against HIV-1 (Aids Virus), TB, bacteria and fungi.
- EPA registered.

	Effective	Non-Caustic	No Special Handling or Disposal	Non-Irritating
Sklar Soak™	Yes	Yes	Yes	Yes
Glutaraldehydes	Maybe	No	No	No
Phenols	Sometimes	No	No	No
Chlorine	Sometimes	No	No	No



Sklar Soak™
Liquid
10-1602
Case of 12-8 Oz. Bottles



Sklar Soak™
Liquid
10-1603
Case of 4 Gallons
10-1604
5 Gallon Container

Step B. Cleaning

Sklar Recognizes That User Requirements Vary. Therefore, Sklar Offers Four Custom Detergent Formulations.

- **Sklar Enzymatic™**
- **Sklar Kleen Powder™**
- **Sklar Kleen Liquid™**
- **Sklar Kleen LF (Low Foam)™**

Sklar Enzymatic™ ***Detergent***

Rapidly dissolves organic debris on instruments and clothes.

SKLAR ENZYMATIC™ DETERGENT is a low-foaming, quick cleaning detergent specifically designed for use in areas where instruments and/or cloth materials may become soiled with organic debris. SKLAR ENZYMATIC™ DETERGENT may be used as a manual instrument cleaner; as a pre-soak for blood-contaminated linens, clothing and instruments; in ultrasonic units; and in washer/sterilizer/decontaminators. It contains no animal enzymes and maintains a pleasant odor. It contains four enzymes and three enhancers that make it exceptionally effective in breaking down protein, blood and fat from lumens, box locks and channels. When used as directed, the enzymatic's pH neutral formula is safe for use on rubber, plastic, stainless steel instruments, surgical equipment as well as linens, etc. It is 100% biodegradable, is not a carcinogen, and may be used in temperatures up to 180°F.

Sklar Enzymatic™

Detergent	10-2775
10-2770	Case of 2-1 Gallon
Case of 6-32 Oz. Bottles	10-2777
	Case of 4-1 Gallon





Sklar Kleen™

For Hand and Ultrasonic Cleaning

Specially formulated for both hand and ultrasonic cleaning, SKLAR KLEEN™ provides superior wetting power to penetrate locks, serrations and crevices of surgical instruments, glassware, plastics and rubber.

Sklar Kleen Powder™

The pH balanced formula of SKLAR KLEEN™ is an excellent way to reduce or eliminate the effects of corrosive minerals that are inherent in virtually all communities' water supplies. One 3 1/4 pound container makes in excess of 150 gallons of cleaning solution.

Sklar Kleen Liquid™

SKLAR KLEEN LIQUID™ is non-corrosive, non-aggressive, phosphate free and biodegradable. We have specifically developed SKLAR KLEEN LIQUID™ for manual and ultrasonic cleaning.

It is moderately alkaline, affording optimum cleaning without etching glassware or attacking instrument metal. Concentrated—1 gallon makes 750 gallons of cleaning solution.

SKLAR KLEEN LIQUID

- 10-1612 Case of 6-8 Oz. Bottles
- 10-1613 Case of 4 Gallons
- 10-1614 5 Gallon Jug

SKLAR KLEEN

Powder

- 10-1606 Case of 6-2 Lb. Jars
- 10-1630 Case of 6- 3 1/4 Lb. Pitchers
- 10-1631 Case of 6- 3 1/4 Lb. Jars

SKLAR KLEEN

Powder

- 10-1607 5 Lb. Pail
- 10-1608 30 Lb. Pail
- 10-2780 60 Lb. Pail
- 10-1632 100 Lb. Drum

Sklar Kleen LF™

Low Foam—For Washers

SKLAR KLEEN LF™ (Low Foam) is an especially effective and economical liquid cleaner for surgical instruments and laboratory glassware. SKLAR KLEEN LF™ maintains a low foam level to assure efficient and trouble-free action in instrument washer/sterilizers and tunnel washers. The low, non-aggressive pH (7.5 ± 0.5) is non-corroding to surgical instrumentation and will not etch glassware. SKLAR KLEEN LF™ concentration and viscosity are maintained to disburse quickly and are well suited for automatic injection systems. SKLAR KLEEN LF™ is highly concentrated, 1/6 oz. (5 ml.) per gallon of water, and provides a very cost-effective solution.

SKLAR KLEEN LF

Liquid

- 10-2701 Case of 4-1 Gallon
- 10-2705 5 Gallon Jug
- 10-2730 30 Gallon Container
- 10-2755 55 Gallon Container



Step C.

Sklar Lube™

Extends Instrument Life And Performance



SKLAR LUBE™ is an easy-to-use, water soluble, non-silicone lubricant and rust inhibitor. When used daily as a second rinse after every cleaning, it keeps box locks operating smoothly, is effective even after autoclaving, and leaves no oily residue.

Regular lubrication is essential no matter which cleaning method is employed (including ultrasonic). SKLAR LUBE™ is ideal for maintaining instrument quality and performance. SKLAR LUBE™ is antimicrobial and anticorrosive.

SKLAR LUBE

- 10-1636 Case of 12-8 Oz. Ready To Use Spray Bottles
10-1635 Case of 4 Gallons-Concentrated

No Steel is Truly "Stainless"

It's a fact that so-called stainless steel is subject to both water-spotting and staining. However what many people identify as a "rust" problem usually turns out to be something else.

Most often the problem is actually a stain caused by a surface deposit. These deposits appear in a variety of colors depending upon the type of deposit involved. Once the cause is found and eliminated, most of the time the problem quickly diminishes or disappears completely.

As you probably know, stainless steel is ideally suited for the surgical suite because it is rust resistant, it can be honed to an extremely sharp edge or fine point, and it can be hardened to maintain the delicate, yet precise, requirements of the surgeon. But it is this hardenable quality – the amount of carbon used during the manufacturing process – coupled with harsh chemicals and improper care that renders stainless steel susceptible to corrosion.

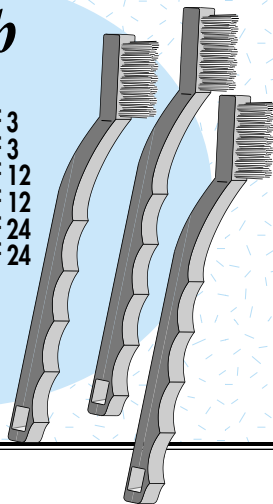
Sklar's products are specially formulated to provide cost effective instrument care.

Step D.

Sklar Recommends Autoclaving

Instrument Cleaning Brush

- | | | |
|---------|-----------------|------------|
| 10-1650 | Stainless Steel | Pack of 3 |
| 10-1651 | Nylon | Pack of 3 |
| 10-1652 | Stainless Steel | Pack of 12 |
| 10-1657 | Nylon | Pack of 12 |
| 10-1658 | Stainless Steel | Pack of 24 |
| 10-1659 | Nylon | Pack of 24 |



Sklar Cleaning Accessories

Sklar Polish™

Is The Answer To Tough Stains And Tarnish

Sklar Polish™ is safe for all your stainless steel, chrome, nickel, brass, instrument trays, basins and racks. It also works well on all porcelain and tile surfaces.

The true value in regular Sklar Polish™ use is that it removes minerals from your instruments and other metal surfaces without changing the surface qualities of the items.

- 10-1626
Case of 12-8 Oz. Jars
- 10-1629
Case of 6-8 Oz. Jars



Sklar Surgical Instrument Trouble Shooting Guide

Corrosion

- Problem:** Debris and residue in box locks, serrations and ratchets.
- Solution:** Serrations, box locks and ratchets should be carefully cleaned and rinsed. A soft bristle brush is effective in these difficult areas.
- Problem:** Moisture remaining on the instruments within the sterile wrapped packs; excessive moisture in autoclave during sterilization and termination of cycle.
- Solution:** Preheat autoclave – drying time cannot be accelerated – open autoclave door slightly. Routinely inspect valves. Malfunctioning valves can precipitate corrosion.
- Problem:** Some local water supplies contain excessive quantities of alkali. This can manifest itself by depositing corrosive matter on the instruments.
- Solution:** It is generally accepted that cold distilled or demineralized water be used during sterilization. An alternative is to use the local water supply, while instituting a program of preventative maintenance. Carefully clean surfaces with SKLAR KLEEN™, using SKLAR POLISH™ to remove difficult stains and SKLAR LUBE™ for proper lubrication.

Pitting

- Problem:** Instruments are inevitably exposed to chemical compounds that initiate pitting. The most common are saline solutions and blood.
- Solution:** It is essential that instruments be rinsed with distilled or demineralized water and then cleaned routinely.
- Problem:** Some Non-Sklar detergents contain a chloride or have an acid base. If rinsing is not thorough, the residual detergent can precipitate pitting. Hydrochloric acid can be formed by the combination of chloride in the cleaner and steam, causing the instrument to pit.
- Solution:** Evaluate detergents without a chloride base. SKLAR KLEEN™ is recommended.
- Problem:** Instruments may be pitted when the detergent used has an excessively high PH. If instruments are not rinsed thoroughly, and then autoclaved, the heat increases the effect of the solution on the instruments.
- Solution:** Use only detergents specifically developed for instrument cleaning. Sklar Kleen™ products are pH balanced.

Brownish Stain

- Problem:** This stain is more obvious on dull finish

instruments. Most likely, it is a deposit of chromium oxide. The thin hard layer protects stainless steel from corrosion precipitated by the atmosphere. The brownish film (sometimes dull blue) occurs naturally when stainless is heated. Occasionally this stain can be traced to the sterilizer. Improper cleaning compounds could contain polyphosphates that cause the copper components in the sterilizer to be deposited by electrolytic action on the stainless steel instruments.

Solution: Water supply to autoclave should be cold and demineralized. Use the correct amount of SKLAR KLEEN™ as recommended by the manufacturer.

Bluish Gray Stains

- Problem:** Cold sterilizing solutions.
- Solution:** In the preparation of the solution make certain the manufacturer's directions are followed accurately. To minimize discoloration use distilled water and add a rust inhibitor. Using the solution beyond recommended time limitations will cause the solution to become corrosive.

Rust Deposit

- Problem:** Sterilizing instruments of different metals in the same cycle will cause rusting. An electrolytic action carries the carbon particles from the exposed metal and deposits them on the stainless steel instruments. The rapid oxidation of molecules results in a surface film of rust.
- Solution:** The ideal technique would be to sterilize the two types of instruments separately. It is recommended that chrome plated instruments that indicate signs of peeling or flaking be replaced with stainless steel instruments.
- Problem:** The rust film on the surface of stainless steel instruments can be caused by chemicals in the detergent. Excess amounts of iron or other minerals from the local water supply may cause the rust deposits.
- Solution:** It is recommended that instruments be rinsed with distilled or demineralized water. Surface rust can be removed by light buffing or an application of SKLAR POLISH™.

Light and Dark Colored Spots

- Problem:** Spotting caused by slow evaporation of water drops identified with the mineral content of the water.
- Solution:** Eliminate water droplets by adhering to autoclave manufacturer's operating instructions. Autoclave door should not be opened until steam has been completely vented.

Sklar Disinfectant™

Sklar Has The Safer Solution!

	Sklar Disinfectant™	Chlorine Compounds	Alcohols	Iodophors (Iodines)	Phenols	Quaternary Compounds (Ammonium Derivatives)	Acid Glutaraldehyde	3.2% Glutaraldehyde	2% Glutaraldehyde	
EPA registered as disinfectant	Yes	No	No	Yes	Yes	Yes	Yes	Yes	Yes	
Use for both cleaning and disinfecting	Yes	N/R	N/R	N/R	N/R	N/R	N/R	N/R	N/R	
No special handling	Yes	No	No	No	No	Yes	No	No	No	
Safe for use on environmental surfaces	Yes	N/R	N/R	Stains	Some	Yes	No	No	No	
Non-caustic	Yes	No	No	No	No	Yes	No	No	No	
No special disposal	Yes	No	No	No	No	Yes	No	No	No	
Bactericidal	Yes	N/R	Yes	Yes	Yes	Yes	Yes	Yes	Yes	
Virucidal <small>Encapsulated</small>	Yes	No	No	Yes	No	No	Yes	Yes	Yes	
Virucidal <small>Non-encapsulated</small>	Yes	Yes	Yes	Yes	Yes	Yes	Yes	Yes	Yes	
Fungicidal	Yes	N/R	Yes	Yes	Yes	Yes	Yes	Yes	Yes	
Tuberculocidal	Yes	N/R	Yes	Yes	Yes	No	Yes	Yes	Yes	
Recommended time TB present 20°C 68°F (Fresh Sol.)	10 Min.	N/R	N/R	N/R	N/R	N/R	20 Min. Heated	25 Min. Heated	45 Min. Heated	
Special Precautions or Instructions	None	Wear eye, skin and respiratory protection		Extremely flammable	Will cause staining on some surfaces	Wear eye and skin protection	Rinse with water	Wear eye, skin and respiratory protection		Use only on pre-cleaned items.

N/R=Not Recommended



*Sklar Disinfectant*TM

- **Glutaraldehyde-Free!**
- **Is specially formulated for the control of cross contamination.**
- **Effective against TB, viruses including HIV-1 (Aids Virus), bacteria and fungi on inanimate objects.**
- **Non-irritating formula.**
- **EPA registered.**

	<i>Effective</i>	<i>Non-Caustic</i>	<i>No Special Handling or Disposal</i>	<i>Non-Irritating</i>
<i>Sklar Disinfectant</i> TM	Yes	Yes	Yes	Yes
<i>Glutaraldehydes</i>	<i>Maybe</i>	<i>No</i>	<i>No</i>	<i>No</i>
<i>Phenols</i>	<i>Sometimes</i>	<i>No</i>	<i>No</i>	<i>No</i>
<i>Chlorine</i>	<i>Sometimes</i>	<i>No</i>	<i>No</i>	<i>No</i>



*Sklar Disinfectant*TM

- 10-2762
Case of 12-24 Oz. Spray Bottles
- 10-1643
Case of 6-24 Oz. Spray Bottles
- 10-2760
Case of 12-8 Oz. Spray Bottles



*Sklar Disinfectant*TM

- Liquid
- 10-1653
Case of 4 Gallons



SKLAR SOAK™

Liquid

- 10-1602 Case of 12-8 Oz. Bottles
- 10-1603 Case of 4 Gallons
- 10-1604 5 Gallon Container

SAFETY

No need to handle instruments before disinfecting. Pre-cleans and disinfects soiled instruments in one safer, more efficient step.

NO SPECIAL HANDLING

Contains no dangerous phenols that require skin, eye or respiratory protection. No disposal restrictions, no toxic fumes or emissions.

ALL PURPOSE SOAK

Approved for use on surgical instruments, plastics, stainless steel, chrome, glass, plexiglass, nurseries, OR lights, respiratory therapy equipment and painted surfaces.

Sklar

SKLAR DISINFECTANT™

Liquid

- 10-1643 Case of 6-24 Oz. Spray Bottles
- 10-2762 Case of 12-24 Oz. Spray Bottles
- 10-2760 Case of 12-8 oz. Liquid Spray Bottles
- 10-1653 Case of 4-1 Gallon



ECONOMICAL

Clean and disinfect using the same product.
No need to purchase and store other products.

CONVENIENT

No mixing, no measuring, just use as supplied. No rinsing required. Formulated to help avoid cross contamination on inanimate objects and surfaces.

NO SPECIAL HANDLING

Contains no dangerous phenols that require skin, eye or respiratory protection. No disposal restrictions, no toxic fumes or emissions.



SKLAR KLEEN LF™

Low Foam (Liquid)

- 10-2701 Case of 4-1 Gallon
- 10-2705 5 Gallon Jug
- 10-2730 30 Gallon Container
- 10-2755 55 Gallon Drum

For use in washer/sterilizers and mechanical washers. Safe for all metals, glassware, plastics, and rubber.

Non-corroding to surgical instrument alloys; non-etching to glassware.

Only 1/8 oz. liquid per gallon of water. Available in a variety of sizes.



SKLAR ENZYMATIC™

Detergent

- 10-2770 Case of 6-1 Quart
- 10-2775 Case of 2-1 Gallon
- 10-2777 Case of 4-1 Gallon

Safe on rubber, plastic, cloth, as well as instruments.

Usable in washer/sterilizer and mechanical washers and decontaminators.

Non-caustic, non-flammable, 100% biodegradable, Concentrated.



SKLAR KLEEN™

Powder

- 10-1606 Case of 6-2 Lb. Jars
- 10-1630 Case of 6-3/4 Lb. Pitcher
- 10-1631 Case of 6-3/4 Lb. Jars

Only 1 to 2 tablespoons of concentrated powder per gallon of water. Available in a variety of sizes.

Superior wetting power of Sklar Kleen penetrates crevices to lift away organic debris.

PH balanced, for use in manual or ultrasonic cleaning. Safe for all metals, glassware, plastics, and rubber. Biodegradable.



Powder

- 10-1607 5 Lb. Pail
- 10-1608 30 Lb. Pail
- 10-2780 60 Lb. Drum
- 10-1632 100 Lb. Drum

Why Sklar?

Who knows more about the cost, effective care, cleaning and disinfecting of surgical instruments?

Technical Hotline
(800) 822-0124



SKLAR KLEEN™

- Liquid
- 10-1612 Case of 6-8 Oz. liquid
 - 10-1613 Case of 4 Gallons
 - 10-1614 5 Gallon Jug

For manual and ultrasonic cleaning.

Non-corrosive, non-aggressive, phosphate free and biodegradable.

Concentrated—1 gallon makes 750 gallons of cleaning solution.



SKLAR LUBE™

- Liquid
- 10-1636 Case of 12, Ready to use spray 8 Oz. Bottles
 - 10-1635 Case of 4 Gallons

Effective, non-toxic formula keeps instruments looking and operating like new.

It's concentrated! One gallon makes 5 gallons of lubricant.

Contains anti-corrosives that help prevent staining that occurs on many instruments.



SKLAR POLISH™

- 10-1626 Case/12-8 Oz. Jars
- 10-1629 Case/6-8 Oz. Jars

Extends the life of surgical instruments by removing corrosive stains.

Non-toxic powder does not pose the health hazards of some liquid stain removers.

For use on surgical instruments, stainless sinks and countertops, as well as porcelain and tile.



SKLAR SOAP™

- Anti-microbial Soap
- 10-1618 Case of 12-16 Oz. Pumps
 - 10-1619 1 Gallon Refill
 - 10-1620 32 Oz. Refill

Strong anti-microbial action

Mild enough to use anytime you wash, even as a shower soap.

Doesn't dry or chap hands.

SKLAR SOAK IS EFFECTIVE!

Tuberculocidal

**Efficacy
Tuberculosis
Quantitative**

Virucidal

**Efficacy
Polio 1 & 2
Herpes 1 & 2
Coxsackie**

Fungicidal

**Efficacy
Aspergillus
Niger
Trichophyton
Mentagrophytes**

Bactericidal

**Efficacy
Salmonella
Staphylococcus
Pseudomonas 3**

***HIV-1
(Aids Virus)***

**Efficacy
HIV-1**

Efficacy Sheets
Available Upon Request.

Safe For You, Your Instruments and Your Environment.



Material Safety Data Sheet		SKLAR SOAK			
Sklar Instruments Distributor 889 South Matlack Street Address West Chester, PA 19382 (215) 430-3200 Phone Number (For Information) Chem-Tel 1-800-255-3824 Emergency Phone Number Telrex*		Identity (Trade Name As Used On Label) 91-MSD104 MSDS Number* N/A CAS Number* 3-9-92 Date Prepared Sklar Instruments Prepared By: Note: Blank spaces are not permitted. If any item is not applicable, or no information is available, the space must be marked to indicate that.			
SECTION 1 - MATERIAL IDENTIFICATION AND INFORMATION					
COMPONENTS—Chemical Name & Common Name (Hazardous Components 1% or greater; Carcinogens 0.1% or greater)		%*	OSHA PEL	ACGIH TLV	OTHER LIMITS RECOMMENDATIONS
Isopropanol		15	N/A	N/A	N/A
Non-Hazardous Ingredients		85			
Total		100			
SECTION 2 - PHYSICAL/CHEMICAL CHARACTERISTICS					
Boiling Point	170° - 200° F	Specific Gravity (H ₂ O = 1)	1.015		
Vapor Pressure (mm Hg and Temperature)	0.2 - 4.7	Melting Point	N/A		
Vapor Density (Air = 1)	+1	Evaporation Rate	= 1) Similar to water		
Solubility in Water	100%	Water Solubility	N/A		
PRIMARY ROUTES OF ENTRY <input type="checkbox"/> Inhalation <input type="checkbox"/> Skin Absorption <input type="checkbox"/> Not Hazardous		<input type="checkbox"/> Eye Irritation <input type="checkbox"/> Not Hazardous		LEL	UEL
HEALTH HAZARDS Acute None Known. Chronic None Known.					
Signs and Symptoms of Exposure See Above Health Hazards					
Medical Conditions Generally Aggravated by Exposure None Known.					
EMERGENCY FIRST AID PROCEDURES - Seek medical assistance					

Sklar Soak™

Compare Our MSDS To Your Present Product

Material Safety Data Sheets Enclosed in Every Case.

CLEANING & STERILIZING PRODUCTS



SKLAR SOAK

Instrument Immersion Solution
Liquid

- 10-1602 Case of 12, 8 Oz. Bottles
- 10-1603 Case of 4, 1 Gallon
- 10-1604 5 Gallon Container



SKLAR KLEEN

Detergent Powder

- 10-1606 Case of 6, 2 Lb. Jars
- 10-1630 Case of 6, 3 1/4 Lb. Pitcher
- 10-1631 Case of 6, 3 1/4 Lb. Jars



SKLAR KLEEN

Detergent Powder

- 10-1607 5 Lb. Pail
- 10-1608 30 Lb. Pail
- 10-2780 60 Lb. Drum
- 10-1632 100 Lb. Drum



SKLAR KLEEN LIQUID

Detergent

- 10-1612 Case of 6, 8 Oz. liquid bottles
- 10-1613 Case of 4, 1 Gallon
- 10-1614 5 Gallon Container



SKLAR KLEEN LF

Low Foam (Liquid) Detergent

- 10-2701 Case of 4, 1 Gallon
- 10-2705 5 Gallon Jug
- 10-2730 30 Gallon Container
- 10-2755 55 Gallon Drum



SKLAR ENZYMATIC

Detergent

- 10-2770 Case of 6, 1 Quart
- 10-2775 Case of 2, 1 Gallon
- 10-2777 Case of 4, 1 Gallon



SKLAR LUBE

Liquid

- 10-1636 Case of 12, Ready to Use 8 Oz. Bottles
- 10-1635 Case of 4 Gallons Concentrated



SKLAR DISINFECTANT

Liquid

- 10-1643 Case of 6, 24 Oz. Spray Bottles
- 10-2762 Case of 12, 24 Oz. Spray Bottles
- 10-2760 Case of 12, 8 Oz. Spray Bottles



SKLAR DISINFECTANT

Liquid

- 10-1653 Case of 4, 1 Gallon
- 10-2763 5 Gallon Container



SKLAR POLISH

- 10-1626 Case of 12, 8 Oz. Jars
- 10-1629 Case of 6, 8 Oz. Jars



SKLAR ANTI-MICROBIAL

Soap

- 10-1618 Case of 12, 16 Oz. Pumps
- 10-1619 1 Gallon Refill
- 10-1620 32 Oz. Refill



SKLAR CREAM

Professional Skin Lotion

- 10-1622 Case of 12, 16 Oz. Pumps

SKLAR INSTRU-GUARD™

ONE-STEP INSTRUMENT CLEANER & LUBRICANT



This multi-purpose cleaner is chemically engineered for use as a presoak, for manual cleaning and in washer/sterilizers, washer/decontaminators, manual systems, ultrasonic cleaners, and cart washers.



Sklar Instru-Guard™ *One-Step Instrument Cleaner and Lubricant*

Ordering Information:

Gallon	10-2800
5 Gallon	10-2802
15 Gallon	10-2804
30 Gallon	10-2806

Eliminates Milking–

A special penetrating lubricant is blended into the formula, protecting the instruments and extending their life.

Cleaner & Brighter Instruments, Fast–

The detergents and emulsifiers quickly break up and remove organic soils from box locks and other hard-to-reach places, virtually restoring the feel of a new instrument.

Removes Stains, Blood Rust and Mineral Deposits–

Sklar Instru-Guard™ One-Step Instrument Cleaner & Lubricant contains four rust inhibitors to control corrosion and eliminate scaling and spotting.

Biodegradable–

Does not contain phosphates.

Lower Cost Per Use–

Sklar Instru-Guard™ One-Step Instrument Cleaner & Lubricant can reduce the time and cost involved in processing your instruments by cleaning and lubricating in one easy step.



The Tradition Continues

Sklar

SKLAR INSTRU-GUARD™ DUAL ENZYMATIC DETERGENT

A unique proteolytic enzyme detergent formulation that doubles as a presoak and cleaner. Sklar Instru-Guard™ DUAL ENZYMATIC DETERGENT provides for simple one-step cleaning of your most delicate equipment, including endoscopes. Sklar Instru-Guard™ DUAL ENZYMATIC DETERGENT decreases the need for excessive manual handling of contaminated equipment.



Effective—

Two proteolytic enzymes and a powerful detergent base efficiently dissolve organic solids, particularly in hard-to-reach places such as lumens, channels and box locks. Helps prevent air/water clogging.

Safe For Instruments—

This neutral detergent is non-corrosive, and is compatible with medical and surgical equipment.

Low Foaming—

Can be used in automatic and manual systems.

Economical—

Concentrated liquid; mix 1 ounce of Sklar Instru-Guard™ DUAL ENZYMATIC DETERGENT per gallon of warm water.

Fast—

Minimum 10-minute soak time is recommended for blood removal.

Sklar Instru-Guard™ Dual Enzymatic Detergent

Ordering Information:

Quart	10-2790
½ Gallon	10-2792
Gallon	10-2794



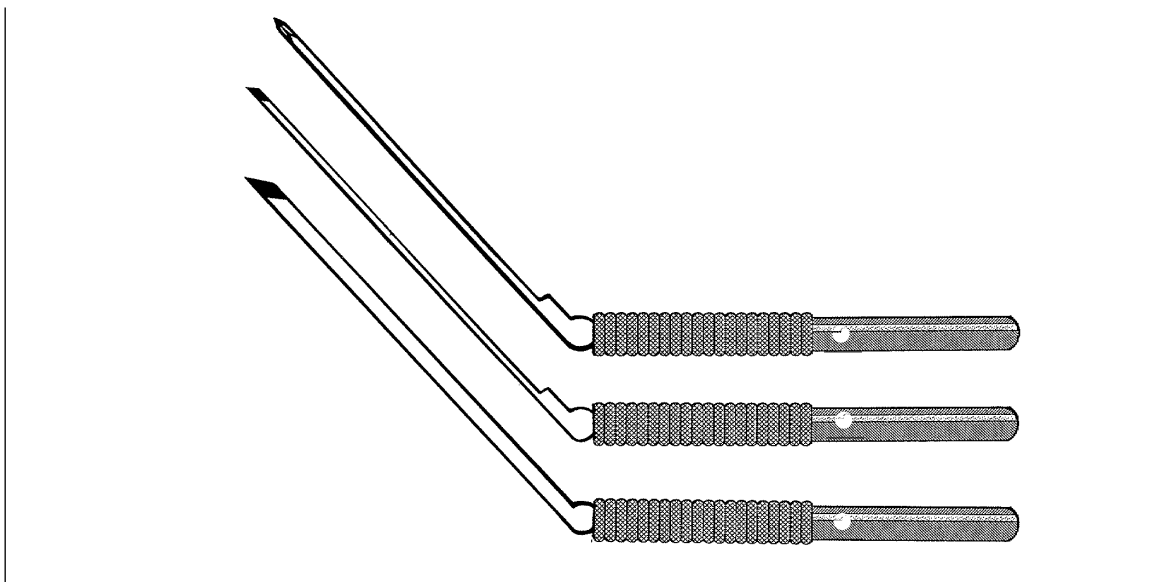
The Tradition Continues



DISPOSABLE EAR CURETTE

Pack of 12		Non-Autoclavable
96-1000	Cup End	12 Each
96-1001	Cup End	50 Each
96-1005	Loop End	12 Each
96-1006	Loop End	50 Each
96-1010	Ring End	12 Each
96-1011	Ring End	50 Each

Manufactured from a cold sterilizable polymer. Sklar Ear Spoons and Ear Loops are inexpensive and effective. Firm, yet pliable, these disposable curettes eliminate the risk of cross infection.



DISPOSABLE MINITURE EAR KNIVES

Sterile	Pack of 12	Non-Autoclavable	
67-2020	Ear Knife Angled	Broad Tip	71
67-2022	Ear Knife Angled	Narrow Tip	71-N
67-2024	Ear Knife Angled	Spear Tip	71-S

Sklar

**SKLARSCRIBE
SURGICAL SKIN MARKER**

SKLARSCRIBE

Surgical Skin Marker



A Complete Surgical
Skin Marking Kit With
A Measurable Difference.

Peel:

the sterile, fiber free pouch...

Measure:

with a convenient, separate
flexible ruler (inches & metric)...

Mark:

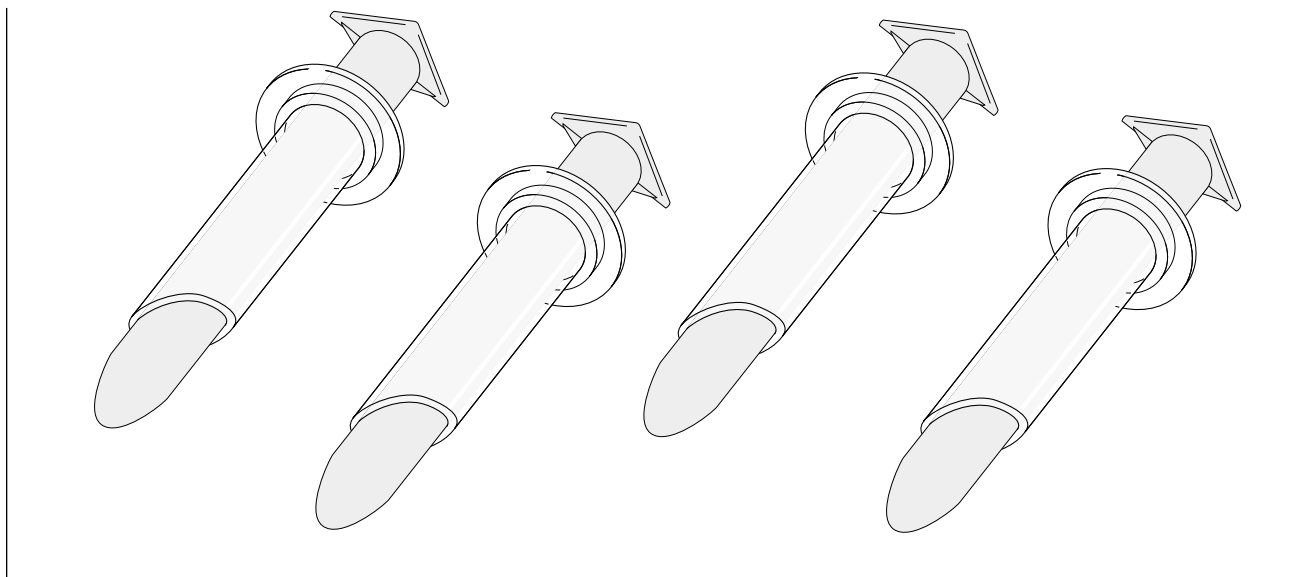
with *SKLAR SCRIBE* in scrub resistant ink.

Individual Sterile Pack

10-1641	Pack of 10
10-1640	Case of 100



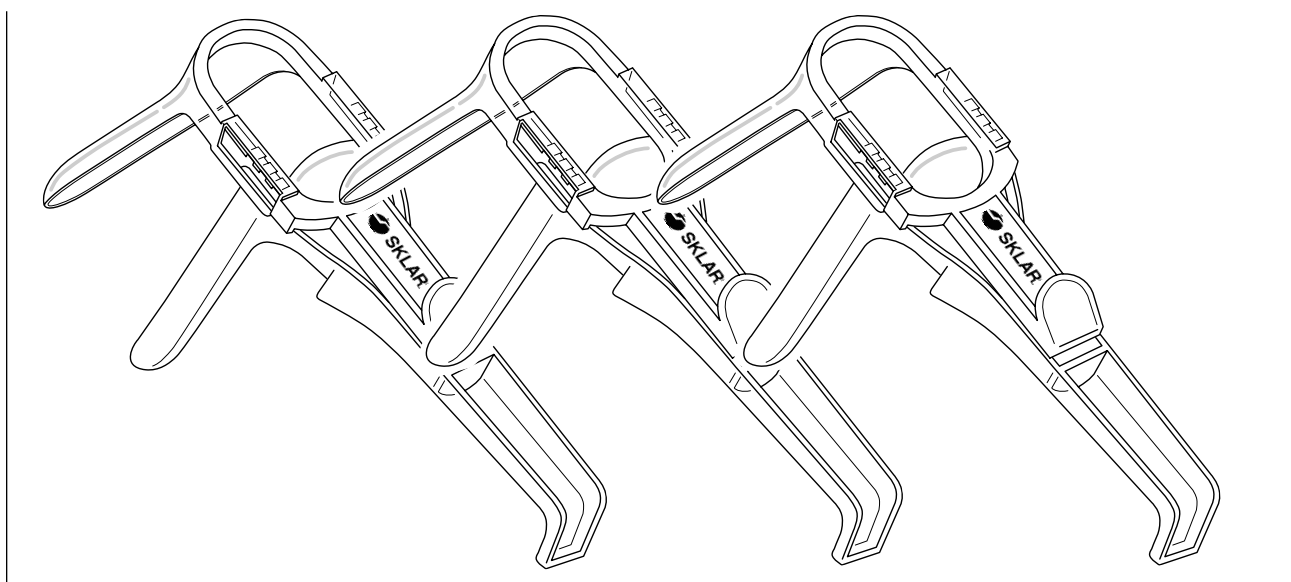
The Tradition Continues



HIRSCHMAN TYPE PROCTOSCOPE

96-0910 Medium Pack of 25

The Sklar disposable proctoscope is convenient and easy to use. The transparent material offers a wider field of view during surgery or examination while eliminating the risk of cross infection.



GRAVES TYPE SPECULUM

Pack Of 10-Non-Sterile
96-0862 Medium

Similar in shape to the Graves Speculum, the Sklar disposable speculum offers a high quality, ready to use alternative to stainless. The transparent material offers a wide field of view, while reducing the risk of cross contamination.

Major Basic Surgery Set (98-1000)

Number	Description	Qty.	Number	Description	Qty.
98-1000	Complete Set		30-1560	Probe Dbl End 6"	2
06-2860	Metal Ruler 6"	1	30-1960	Probe W/Eye 6"	2
06-2903	Scalpel Handle #3	2	36-1662	Babcock Intestinal Forceps 6¼"	2
06-2904	Scalpel Handle #4	2	36-1677	Babcock Intestinal Forceps 8"	2
07-1801	Yankauer Suction Tube Slip on End	2	36-2160	Allis Tissue Forceps 4x5 6"	3
10-1805	Weinstein Sterilizing Rack 11¼"	3	36-2275	Allis Tissue Forceps 5x6 7½"	6
15-1555	Mayo Dissecting Scissors Str 5½"	1	47-1447	Brown Adson Tissue Forceps 4 ¾"	2
15-2567	Mayo Dissecting Scissors Cvd 6¾"	1	47-2147	Adson Forceps Serr Jaw 4¾"	1
17-1235	Hartmann Mosquito Str Del Ser 3½"	3	47-2955	Backhaus Towel Clamp 5¼"	12
17-1335	Hartmann Mosquito Cvd Del Ser 3½"	3	55-9090	Metz-Nelson Scissors Cvd 9"	1
17-1450	Halsted Mosquito Forceps Str 5"	6	60-1085	US Army Retractor Set/2 8½"	2
17-1550	Halsted Mosquito Forceps Cvd 5"	6	60-1681	Richardson Retractor	
17-2262	Roch-Pean Forceps Cvd 6¼"	6		w/Sklar-Grip Handle Med	1
17-2280	Roch-Pean Forceps Cvd 8"	3	60-1691	Richardson Retractor	
17-2462	Roch-Pean Forceps Str 6¼"	6		w/Sklar-Grip Handle Large	1
17-2480	Roch-Pean Forceps Str 8"	3	60-1695	Richardson-Eastman Retractor Set/2	1
17-2662	Roch-Ochsner Forceps Cvd 6¼"	2	60-2713	Deaver Retractor	
17-2862	Roch-Ochsner Forceps Str 6¼"	2		Sklar Grip Handle #2 1" x 13"	2
17-2880	Roch-Ochsner Forceps Str 8"	2	60-3090	Deaver Retractor #0 1" x 9"	2
17-3055	Crile Forceps Str 5½"	12	60-3212	Deaver Retractor #3 1½" x 12"	2
17-3155	Crile Forceps Cvd 5½"	12	60-3312	Deaver Retractor #4 2" x 12"	1
19-1055	Dressing Forceps 5½"	2	60-3598	Zalkind Ribbon Retractor ¾" x 7"	2
19-1080	Dressing Forceps 8"	2	60-3610	Zalkind Retractor Malleable 1" x 13"	2
19-1255	Tissue Forceps 1x2 5½"	3	60-3615	Zalkind Retractor Malleable 1½" x 13"	2
19-1280	Tissue Forceps 1x2 8"	1	60-6162	Mathieu Retractor D/E Sharp 6¼"	2
19-2280	Russian Tissue Forceps 8"	2	60-6164	Senn Retractor D/E Blunt 6¼"	2
21-8031	Mayo-Hegar NH Serr 6" T-C	2	60-6670	Balfour Abdominal Retractor 7"	1
21-8032	Mayo-Hegar NH Serr 7" T-C	2	74-3075	Schmidt Hemostat Half Cvd Jaws 7½"	2
23-1106	Sklarlite Operating Scissors S/B St 5½"	2	75-5670	Metzenbaum Scissors Cvd 7"	2
23-1130	Sklarlite Operating Scissors S/B Cvd 5½"	2	87-2195	Foerster Sponge Forceps Str Serr 9½"	2
23-1157	Sklarlite Stevens Cvd 4¼"	1	87-2395	Foerster Sponge Forceps Cvd Serr 9½"	2

Sklar Offers Special Pricing on Sets



Minor Basic Surgery Set (98-1002)

Number	Description	Qty.
98-1002	Complete Set	
06-2903	Scalpel Handle #3	2
06-2904	Scalpel Handle #4	2
07-1801	Yankauer Suction Tube Slipon End.....	2
15-2555	Mayo Dissecting Scissors Cvd 5½ ".....	1
15-2567	Mayo Dissecting Scissors Cvd 6¾ ".....	1
17-1450	Halsted Mosquito Forceps Str 5".....	6
17-1550	Halsted Mosquito Forceps Cvd 5".....	6
17-3055	Crile Forceps Str 5 ½".....	12
17-3155	Crile Forceps Cvd 5½".....	12
19-1055	Dressing Forceps 5½".....	2
19-1080	Dressing Forceps 8".....	1
19-1255	Tissue Forceps 1x2 5 ½".....	3
21-8031	Mayo-Hegar NH Serr 6" T-C.....	2
23-1102	Sklarlite Operating Scissors SS St 5½ ".....	2
23-1166	Sklarlite Mayo Dissecting Scissors Cvd 5½ ".....	1
23-1167	Sklarlite Mayo Dissecting Scissors Cvd 6¾ ".....	1
30-1560	Probe D/E 6".....	2
36-2160	Allis Tissue Forceps 4x5 6".....	3
47-1447	Brown Adson Tissue Forceps 4¾".....	2
47-2955	Backhaus Towel Clamp 5 ¼ ".....	12
50-2008	Frazier Suction Tube 8 Fr.....	1
60-1075	Goelet D/E Retractor 1¼" x 1½".....	2
60-1085	US Army Retractor Set/2 8 ½".....	2
60-3598	Zalkind Ribbon Retractor ¾" x 7".....	2
60-6162	Senn Retractor D/E Sharp 6¼".....	2
60-6164	Senn Retractor D/E Blunt 6¼".....	2
75-5670	Metzenbaum Scissors Cvd 7".....	2
87-2195	Foerster Sponge Forceps Str Serr 9½ ".....	2
87-2395	Foerster Sponge Forceps Cvd Serr 9½ ".....	2

Infant Laparotomy Set (98-1022)

Number	Description	Qty.
98-1022	Complete Set	
22-9030	Baby Balfour Retr.....	1
60-3596	Ribbon Ret ½" x 7".....	1
60-3598	Deaver Retr ¾" x 7".....	1
22-8360	Miller-Senn Retr Sharp.....	1
22-8460	Miller-Senn Retr Blunt.....	1
60-1350	Parker Retr Set of 2.....	1
22-3555	Rochester-Pean 5½" Str.....	3
22-3655	Rochester-Pean 5½" Cvd.....	3
18-1752	Rochester-Ochsner 5½" Str.....	3
18-1852	Rochester-Ochsner 5½" Cvd.....	3
17-3055	Crile Fcps Str 5½".....	4
17-3155	Crile Fcps Cvd 5½".....	4
17-1450	Halsted Mosquito Str 5".....	6
17-1550	Halsted Mosquito Cvd 5".....	6
22-6155	Babcock 5½".....	3
22-6157	Allis 5½" 4 x 5.....	3
47-2047	Adson Tissue Forceps 1 x 2 4¾".....	1
47-2147	Adson Dressing Forceps Serr 4¾".....	1
22-4350	Semkin Tissue Forceps 5".....	1
22-4150	Semkin Dressing Forceps 5".....	1
14-1055	Operating Scissors S/B 5½".....	1
22-1070	Metzenbaum 7" Delicate Cvd.....	1
22-1057	Metzenbaum-Lahey 5¾" Cvd.....	1
06-2903	Scalpel Handle #3.....	2
74-1470	Sponge Forceps 7" Str Serr.....	2
22-6585	Pediatric Yankauer Suction Tube.....	1

**New Hospital Sets Come With
30 Days Extra Dating!**

Gynecological Surgery Set (98-1016)

Number	Description	Qty.
98-1016	Complete Set	
06-2903	Scalpel Handle #3	1
06-2904	Scalpel Handle #4	1
06-2915	Scalpel Handle #3L	1
06-2920	Scalpel Handle #4L	1
07-1805	Yankauer Suction Tube Stainless	1
14-2065	Operating Scissors 6 1/2" Cvd SH/Bl	1
17-1055	Pratt T-Shaped Clamp Str 5 1/2"	2
17-2280	Roch-Pean Forceps Cvd 8"	3
17-2480	Roch-Pean Forceps Str 8"	3
17-2680	Roch-Ochsner Forceps Cvd 8"	3
17-2880	Roch-Ochsner Forceps Str 8"	3
17-3062	Crile Forceps Str 6 1/4"	6
17-3162	Crile Forceps Cvd 6 1/4"	6
19-1080	Dressing Forceps 8"	1
19-1280	Tissue Forceps 1x2 8"	2
19-2280	Russian Tissue Forceps 8"	1
19-2310	Russian Tissue Forceps 10"	1
20-2480	Mayo-Hegar NH 8"	1
20-4682	Heaney NH 8 1/4"	2
21-8032	Mayo-Hegar NH Serr 7" T-C	2
21-8033	Mayo-Hegar NH Serr 8" T-C	2
23-1102	Sklarlite Operating Scissors SS St 5 1/2"	1
23-1106	Sklarlite Operating Scissors SB St 5 1/2"	1
34-2023	Poole Suction Tube Slip on Stn 23 Fr	2
36-2275	Allis Tissue Forceps 5x6 7 1/2"	2
36-2295	Allis Tissue Forceps 5x6 10"	2
47-2955	Backhaus Towel Clamp 5 1/4"	8
51-4382	Potts-Smith Dressing Forceps 8 1/4" T-C	1
55-9090	Metz-Nelson Scissors Cvd 9"	1
55-9190	Metz-Nelson Scissors Str 9"	1
80-1410	Bozeman Forceps Dbl Cvd 10"	2
87-2195	Foerster Sponge Forceps Str Serr 9 1/2"	2
90-1590	Mayo Dissecting Scissors Str 9"	1
90-1690	Mayo Dissecting Scissors Cvd 9"	1
90-1977	Heaney Forceps Lght Single Tooth 7 3/4"	2
90-2177	Heaney Forceps Heavy Single Tooth 7 3/4"	2
90-2680	Phaneuf Uterine Artery Forceps Ang 8"	2
90-2782	De Alvarez Forceps 8 1/4"	2
90-3030	Eastman Retractor Sm Bld 3" x 1 1/2"	1
90-3035	Eastman Retractor Mdm Bld 3 1/2" x 1 1/2"	1
90-3040	Eastman Retractor Lrg Bld 4" x 1 1/2"	1
90-3526	Auvarud Speculum Med 2.5 Lbs Bld	1

Number	Description	Qty.
90-3700	Graves Vaginal Speculum Sm 3/4" x 3"	1
90-3701	Graves Vaginal Speculum Med 1 1/4" x 4"	1
90-3702	Graves Vaginal Speculum Lrg 1 3/8" x 4 1/2"	1
90-4926	Hank Dilator St Of 6 In Khaki Roll	1
90-5413	Simpson Sound Cm Graduation	1
90-7995	Schweizer Uter/Cerv Forceps 9 1/2"	1
91-1290	Schroeder Tenaculum Forceps 9 1/2"	2
97-1560	Allis Grasping Forceps 7 1/2" T-C	2

Hysterectomy Set (98-1024)

Used With Major Basic Set

Number	Description	Qty.
98-1024	Complete Set	
87-2195	Foerster Sponge Forceps Straight 9 1/2"	2
36-2295	Allis Tissue Forceps 5 x 6 Teeth 9 1/2"	2
55-2894	Mixer Rt. Angle Forceps	2
74-3075	Schmidt Curved Hemostat	2
20-4682	Heaney Needle Holders	2
90-2380	Heaney Clamps	6
90-2480	Heaney-Ballentine Clamps Str	2
90-2580	Heaney-Ballentine Clamps Cvd	1
17-2880	Rochester-Ochsner Forceps Straight 8"	8
17-2680	Rochester-Ochsner Forceps Curved 8"	4
15-2567	Mayo Dissecting Scissors Cvd 6 3/4"	1
55-9080	Metzenbaum Scissors Curved	1
19-2280	Russian Tissue Forceps	1
52-5195	DeBakey Tissue Forceps	1
06-2915	Scalpel Handle #3L	1
60-3090	Deaver Retractor 1" x 9"	1
60-3112	Deaver Retractor 1" x 12"	1
60-3212	Deaver Retractor 1 1/2" x 12"	1



D and C Set (98-1014)

Number	Description	Qty.
98-1014	Complete Set	
06-2903	Scalpel Handle #3	1
06-2907	Scalpel Handle #7	1
06-2915	Scalpel Handle #3L	1
17-3062	Crile Forceps Str 6 1/4"	6
17-3162	Crile Forceps Cvd 6 1/4"	6
19-1080	Dressing Forceps 8"	1
19-1280	Tissue Forceps 1x2 8"	1
21-1260	Crile-Murray NH Serr 6" T-C Sklar Grip.....	1
21-8032	Mayo-Hegar NH Serr 7" T-C	1
47-2955	Backhaus Towel Clamp 5 1/4"	6
80-1410	Bozeman Forceps Dbl Cvd 10"	1
87-2395	Foerster Sponge Forceps Cvd Serr 9 1/2"	2
90-3130	Jackson Retractor Sm Bld 3" x 1 1/2"	1
90-3135	Jackson Retractor Mdm Bld 3 1/2" x 1 1/2"	1
90-3526	Auward Speculum Med 2.5 lbs Bld 7x3.8 Cm.....	1
90-3701	Graves Vaginal Speculum Med 1 1/4" x 4"	1
90-3702	Graves Vaginal Speculum Lrg 1 3/8" x 4 1/2"	1
90-3710	Pederson Vaginal Speculum Sm 1/2" x 3"	1
90-3995	Kogan Endospec W/Gauge & Screws.....	1
90-4713	Goodell Dilator Lrg 13"	1
90-4826	Hegar Dilators St Of 8 In Khaki Roll	1
90-5312	Sims Sound Pln 12 1/2"	1
90-5422	Sims Curette Sharp 11" #2	1
90-5423	Sims Curette Sharp 11" #3	1
90-5424	Sims Curette Sharp 11" #4	1
90-5425	Sims Curette Sharp 11" #5	1
90-6612	Kevork-Younger Endo Cur W/Basket 12"	1
91-1290	Schroeder Tenaculum Forceps 9 1/2"	1
92-5095	Javerts Forceps Serr Jaws 9 1/2"	1

Small GYN Biopsy Set (98-1026)

Number	Description	Qty.
98-1026	Complete Set	
91-1290	Schroeder Tenaculum Forceps 9 1/2"	1
90-3990	Kogen Endocervical Speculum Narrow	1
90-8335	Quick Release Iris Hook 9"	1
90-6612	Kevorkian Curette With Basket	1
90-7525	Sklar Oval Biopsy Forceps 3 x 5 mm	1

Gynecological Biopsy Set (98-1018)

Number	Description	Qty.
98-1018	Complete Set	
80-1410	Bozeman Forceps Dbl Cvd 10"	1
87-2195	Foerster Sponge Forceps Str Serr 9 1/2"	2
87-2395	Foerster Sponge Forceps Cvd Serr 9 1/2"	2
90-3526	Auward Speculum Med 2.5Lbs Bld	1
90-3700	Graves Vaginal Speculum Sm 3/4" x 3"	1
90-3701	Graves Vaginal Speculum Med 1/4" x 4"	1
90-3702	Graves Vaginal Speculum Lrg 1 3/8" x 4 1/2"	1
90-3995	Kogan Endospec W/Gauge & Screws.....	1
90-5413	Simpson Sound Cm Graduation.....	1
90-5423	Sims Curette Sharp 11" #3	1
90-6292	Novak Endometrl Cur 9/4" 4mm.....	1
90-6612	Kevork-Younger Endo Cur W/Bas 12"	1
90-6887	Tischler Cerv Biopsy Forceps 8 1/2"	1
90-7492	Gelhorn Biopsy Forceps 9 1/2"	1
90-7710	Bozeman Dbl Cvd 1 Large Ring 10 1/4"	1
91-1290	Schroeder Tenaculum Forceps 9 1/2"	1

Colposcopy Set For Biopsy (98-1040)

Number	Description	Qty.
98-1040	Complete Set	
80-1410	Bozeman Forceps Dbl Cvd 10 1/2"	1
91-1290	Schroeder Tenaculum Forceps 9 1/2"	1
90-3995	Kogan Endocervical Speculum Wide	1
90-8334	Quick Release Emmett Hook 4 mm 9"	1
90-6612	Kevorkian Curette With Basket	1
90-6887	Tischler-Kevorkian Biopsy Forceps	1

Obstetrical Set (98-1020)

Number	Description	Qty.
98-1020	Complete Set	
14-1060	Operating Scissors Str 6" Sh/Bl.....	1
14-2060	Operating Scissors Cvd 6" Sh/Bl.....	1
15-1567	Mayo Dissecting Scissors Str 6 3/4"	1
16-1610	S E Mayo Diss Scissors Cvd 6 3/4" T-C	1
17-2272	Roch-Pean Forceps Cvd 7 1/4"	3
17-2472	Roch-Pean Forceps Str 7 1/4"	3
17-2880	Roch-Ochsner Forceps Str 8"	1
17-3062	Crile Forceps Str 6 1/4"	3
17-3162	Crile Forceps Cvd 6 1/4"	6
19-1060	Dressing Forceps 6"	2
19-1260	Tissue Forceps 1x2 6"	2
19-2280	Russian Tissue Forceps 8"	2
21-8032	Mayo-Hegar NH Serr 7" T-C.....	2
21-8033	Mayo-Hegar NH Serr 8" T-C.....	1
36-2380	Allis-Thoms Forceps 6x7 8"	1
47-2955	Backhaus Towel Clamp 5 1/4"	12
87-2395	Foerster Sponge Forceps Cvd Serr 9 1/2"	2
90-1755	Braun Epstmy Ang 5 1/2"	1
90-3035	Eastman Retractor Mdm Bld 3 1/2" x 1 1/2"	1
90-3040	Eastman Retractor Lrg Bld 4 x 1 1/2"	1
91-4310	Iowa Puncturing Forceps 10"	1
92-1114	Simpson Ob Forceps Long 14 1/4"	1
92-2215	McLane-Tuck-Luikart Ob Forceps 15 1/2"	1
92-2314	Simpson Luikart Ob Forceps 14"	1
92-2912	Laufe Divergent Ob Forceps 12 1/2"	1

Cesarean Section Set (98-1028)

Use With Major Basic Set

Number	Description	Qty.
98-1028	Complete Set	
90-1590	Mayo Dissecting Scissors Straight 9"	1
90-1690	Mayo Dissecting Scissors Curved 9"	1
20-2910	Masson Meedle Holder 10 1/2"	1
21-8060	Heany Needle Holder Curved 8 1/4" T-C	1
90-3135	Jackson Vaginal Retractor	1
90-2680	Phaneuf Forceps Angular 8"	2
90-8065	Hilderbrandt Uterine Hemostatic Forceps 6 1/2"	1
92-1012	DeLee Obstetrical Forceps 12"	1

Rectal Surgery Set (98-1012)

Number	Description	Qty.
98-1012	Complete Set	
06-2903	Scalpel Handle #3	1
06-2904	Scalpel Handle #4	1
13-1055	Operating Scissors Str Sh/Sh 5 1/2"	1
14-1055	Operating Scissors Str Sh/Bl 5 1/2"	1
15-1555	Mayo Dissecting Scissors Str 5 1/2"	1
15-2567	Mayo Dissecting Scissors Cvd 6 3/4"	1
17-1055	Pratt T-Shaped Clamp Str 5 1/2"	2
17-2055	Kelly Forceps Str 5 1/2"	6
17-2155	Kelly Forceps Cvd 5 1/2"	6
17-2272	Roch-Pean Forceps Cvd 7 1/4"	3
17-2472	Roch-Pean Forceps Str 7 1/4"	3
17-2880	Roch-Ochsner Forceps Str 8"	2
17-2957	Pennington Clamp Str 6"	2
19-1060	Dressing Forceps 6"	1
19-1260	Tissue Forceps 1x2 6"	1
21-1260	Crile-Murray NH Serr 6" T-C SG.....	2
21-8032	Mayo-Hegar NH Serr 7" T-C	1
36-2160	Allis Tissue Forceps 4x5 6"	2
36-2275	Allis Tissue Forceps 5x6 7 1/2"	2
47-2955	Backhaus Towel Clamp 5 1/4"	6
50-2010	Frazier Suction Tube 10 Fr	1
50-2012	Frazier Suction Tube 12 Fr	1
75-5670	Metzenbaum Scissors Cvd 7"	1
80-1735	Yeoman Rectal Punch 13 3/8"	1
80-2132	Pratt Rectal Speculum Lrg.....	1
80-2688	Hirschman Anoscope Sm	1
80-2689	Hirschman Anoscope Med	1
80-2690	Hirschman Anoscope Lrg	1
80-2715	Buie Suction Tube W/Valve 15 Fr.....	1
80-2870	Larry Rectal Probe 7 1/8"	1
80-3185	Pratt Crypt Hook Short 8 1/2"	1
80-3510	Barr Crypt Hook D/E 10 1/2"	1
80-3927	Sawyer Retractor Sklar Grip Hdl Med	1
80-3935	Sawyer Retractor Sklar Grip Hdl Lrg	1
87-2395	Foerster Sponge Forceps Cvd Serr 9 1/2"	2

Rudd Clinic Hemorrhoidal Ligation Set (80-1914)

Number	Description	Qty.
80-2245	Rectal Speculum	1
80-1872	Grasping Forceps.....	1
80-1972	100 "O" Rings	1
80-1910	Ligator.....	1



Plastic Surgery Set (98-1004)

Number	Description	Qty.
98-1004	Complete Set	
17-1235	Hartmann Mosquito Str Del Ser 3 1/2"	3
17-1335	Hartmann Mosquito Cvd Del Ser 3 1/2"	3
17-1450	Halsted Mosquito Forceps Str 5"	6
17-1550	Halsted Mosquito Forceps Cvd 5"	6
20-2070	Mayo-Hegar NH 7"	1
21-1260	Crile-Murray NH Serr 6" T-C Sklar Grip	1
21-8013	Ryder Micro NH Serr 6" T-C	1
22-2525	Slender Tip Scissors Cvd 5 1/2"	1
22-2652	Ragnell Dissecting Scissors Cvd 5"	1
22-4150	Semkin Dressing Forceps Nar 5"	2
22-4350	Semkin Tissue Forceps Narrow 1x2 5"	2
22-8360	Miller-Senn Retractor Sh D/E 6"	1
22-8460	Miller-Senn Retractor BI D/E 6"	1
22-9027	Alm Retractor 2 3/4"	1
23-1106	Sklarlite Operating Scissors S/B St 5 1/2"	2
23-1158	Sklarlite Strabismus Scissors Str 4 1/2"	1
23-1164	Sklarlite Mayo Dissecting Scissors Str 5 1/2"	1
23-1167	Sklarlite Mayo Dissecting Scissors Cvd 6 3/4"	1
23-1280	Sklarlite Sklarcut Scissors Blunt Cvd 5 3/4"	1
23-2510	Sklarlite XD Crile Forceps Str 5 1/2"	12
23-2513	Sklarlite XD Crile Forceps Cvd 5 1/2"	12
47-1047	Wagner Scissors Str S/S 4 3/4"	2
47-1068	Wagner Scissors Cvd S/B 4 3/4"	1
47-1447	Brown Adson Tissue Forceps 4 3/4"	2
47-2834	Jansen Retractor Sh 3x3 4"	1
50-1372	Adson Forceps Str 7 1/4"	3
50-1472	Adson Forceps Cvd 7 1/4"	3
50-2012	Frazier Suction Tube 12 Fr	2
50-3047	Adson Tissue Forceps 1x2 4 3/4"	1
50-3147	Adson Dressing Forceps Serr 4 3/4"	1
55-2855	Gemini Clamp Del Ang 5 1/2"	2
57-1445	Crile Retractor D/E Small	2
60-3598	Zalkind Ribbon Retractor 3/4" x 7"	2

Basic Plastic Surgery Set (98-1030)

Number	Description	Qty.
98-1030	Complete Set	
50-2007	Frazier Suction Tube 7 Fr	1
50-1953	Baron Suction Tube 3 Fr	1
50-1955	Baron Suction Tube 5 Fr	1
22-4150	Semkin Tissue Forceps 1 x 2 5"	1
22-4350	Semkin Tissue Forceps Serrated 5"	1
47-1145	Iris Scissors Straight 4 1/2"	1
47-1245	Iris Scissors Curved 4 1/2"	1
50-3047	Adson Tissue Forceps 1 x 2 4 3/4"	1
50-3147	Adson Dressing Forceps Serrated 4 3/4"	1
22-9027	Alm Retractor 2 3/4"	1
22-2652	Ragnell Dissecting Scissors Curved 5"	1
65-6357	Castroviejo Needle Holder Smooth	1
21-8000	Halsey Needle Holder Smooth T-C 5"	1

**Sklar Offers
Special Pricing
on Sets**

**New Hospital
Sets Come With
30 Days Extra
Dating!**

Basic Podiatry Set (98-1010)

Number	Description	Qty.
98-1010	Complete Set	
06-2903	Scalpel Handle #3	1
06-3052	Surgical Blades Non-Ster #11 100'S	1
06-3056	Surgical Blades Non-Ster #15 100'S	1
11-1055	Lister Bandage Scissors 5 1/2"	1
11-1255	Knowles Bandage Scissors 5 1/2"	1
13-1055	Operating Scissors Str Sh/Sh 5 1/2"	1
15-1355	Stitch Scissors Standard 5 1/2"	1
16-2800	Wire Cut Scissors Ang 4 3/4" T-C	1
17-1450	Halsted Mosquito Forceps Str 5"	3
17-1550	Halsted Mosquito Forceps Cvd 5"	3
19-1055	Dressing Forceps 5 1/2"	2
19-1255	Tissue Forceps 1x2 5 1/2"	1
19-3045	Standard Fine Splntr Forceps 4 1/2"	1
19-3050	Physician Splinter Forceps 5"	1
21-8002	Webster NH Smooth 5" T-C	1
21-8027	Olsen-Hegar NH Serr 5 1/2" T-C	1
23-1102	Sklarlite Operating Scissors SS St 5 1/2"	1
23-1106	Sklarlite Operating Scissors SB St 5 1/2"	1
23-1189	Sklarlite Spencer Stitch Scissors 4 1/2"	1
23-2110	Sklarlite Crile Forceps Str 5 1/2"	3
23-2113	Sklarlite Crile Forceps Cvd 5 1/2"	3
23-2602	Sklarlite Adson Tissue 1x2 4 3/4"	2
40-9825	Joseph Rasp Str Hndl 6 1/2"	1
47-2380	Freer D/E Dissector S/B 7"	1
47-2935	Backhaus Towel Clamp 3 1/2"	6
50-1356	Nail Fragmt Forceps Sd-Cv 5 1/2"	1
50-2006	Frazier Suction Tube 6 Fr	2
50-3147	Adson Dressing Forceps Serr 4 3/4"	2
97-0104	Cuticle Scissors Rng Hdl Chr 4"	1
97-0322	Cuticle Nipp Plier Hdl	1
97-0532	Curette/Exc D/E #58 1-2	1
97-0536	Curette/Exc D/E #58 1-3	1
97-0542	Spatula And Packer D/E #91	1
97-0545	Corn Chisel Cvd Edge Spoon	1
97-0554	Ingrown Nail Inst Fenestrated	1
97-1150	Ingrn Nail Splitr Dbl Spr Stnl	1
97-1318	Platypus Nail Forceps Wide 5 1/4"	1

Basic Hand Surgery Set (98-1008)

Number	Description	Qty.
98-1008	Complete Set	
06-2860	Metal Ruler 6"	1
06-2903	Scalpel Handle #3	1
06-2904	Scalpel Handle #4	1
16-2800	Sklar Edge Wire Cut Scissors Ang 4 3/4" T-C	1
17-2655	Roch-Ochsner Forceps Cvd 5 1/2"	1
17-2855	Roch-Ochsner Forceps Str 5 1/2"	1
18-2257	Allis Tenaculum Forceps Del 5 3/4"	2
21-8004	Derf NH Serr 4 3/4" T-C	1
21-8006	Crile-Wood NH Serr Narrow 6" T-C	1
21-8013	Ryder Micro NH Serr 6" T-C	1
22-1241	Stevens Tenot Scissors Cvd 4 1/2"	1
22-1342	Stevens Tenot Scissors Cvd 4 1/2"	1
22-2545	Metz Lahey Scissors Cvd 4 1/2"	1
22-4250	Semkin Dressing Forceps Del 5"	1
22-4450	Semkin Tissue Forceps Del 1x2 5"	2
22-8360	Miller-Senn Retractor Sh D/E 6"	1
23-1153	Sklarlite XD Iris Scissors Str 4 1/8"	1
23-1155	Sklarlite XD Iris Scissors Cvd 4 1/8"	1
23-1168	Sklarlite XD Mayo Dissecting Str 5 1/2"	1
23-1170	Sklarlite XD Mayo Dissecting Cvd 5 1/2"	1
23-1175	Sklarlite Metz-Lahey Scissors Cvd 6"	1
23-2100	Sklarlite Hartmann Mosquito Str 3 1/2"	3
23-2101	Sklarlite Hartmann Mosquito Cvd 3 1/2"	3
23-2105	Sklarlite Halsted Mosquito Str 5"	6
23-2106	Sklarlite Halsted Mosquito Cvd 5"	6
23-2600	Sklarlite Adson Dressing Ser 4 3/4"	1
23-2602	Sklarlite Adson Tissue 1x2 4 3/4"	2
23-2603	Sklarlite Adson-Brown Sd-Grsp 4 3/4"	1
23-2851	Sklarlite Allis Forceps 4x5 6"	1
23-2861	Sklarlite XD Allis Forceps 4x5 5"	1
41-1070	Reynolds Scissors Serr Cvd 6"	1
47-2380	Freer D/E Dissector S/B 7"	1
47-2500	Joseph Hook 1/Pr Sh 6 1/4"	2
47-2502	Joseph Hook 2/Pr Sh 6 1/4" 2 mm	2
47-2935	Backhaus Towel Clamp 3 1/2"	2
47-2955	Backhaus Towel Clamp 5 1/4"	6
50-1290	Cushing Nerve/Vein Retractor 9"	1
50-2007	Frazier Suction Tube 7 Fr	1
50-2008	Frazier Suction Tube 8 Fr	1
57-1448	Crile Retractor D/E Med	1
60-1085	US Army Retractor Set/2 8 1/2"	1
60-6162	Senn Retractor D/E Sharp 6 1/4"	1
74-1470	Ballenger Sponge Forceps Serr Str 7"	2
74-1670	Ballenger Sponge Forceps Serr Cvd 7"	2
87-2195	Foerster Sponge Forceps Serr Str 9 1/2"	2



Basic Orthopedic Surgery Set (98-1006)

Number	Description	Qty.	Number	Description	Qty.
98-1006	Complete Set		40-2485	Kern Forceps 8½"	1
06-2860	Metal Ruler 6"	1	40-2670	Lewin Bone Forceps Serr 7"	1
06-2903	Scalpel Handle #3	1	40-2922	Lowman Clamp Small Jaw 1½"	1
06-2904	Scalpel Handle #4	1	40-2925	Lowman Clamp 4¾" 1x1½" Jaw	1
11-1060	Lister Bandage Scissors Large Rng 8"	1	40-3177	Liston Bone Forceps Ang 7¾"	1
13-1055	Operating Scissors 5½" Str Sh/Sh	1	40-3710	Stille-Liston Bone Forceps Str 10½"	1
14-1055	Operating Scissors 5½" Str Sh/Bl	2	40-4270	Beyer Rongeur Cvd On Flat 7"	1
14-2055	Operating Scissors 5½" Cvd Sh/Bl	1	40-4272	Ruskin Rongeur Str 7¼"	1
15-1355	Stitch Scissors Standard 5½"	1	40-5780	Hajek Bone Mallet 8"	1
15-1567	Mayo Dissecting Scissors Str 6¾"	1	40-6667	Hibbs Osteotome 9½" x 10 mm	1
15-2567	Mayo Dissecting Scissors Cvd 6¾"	2	40-6668	Hibbs Osteotome 9½" x 13 mm	1
16-2800	S E Wire Cut Scissors Ang 4¾" T-C	1	40-6711	Hibbs Chisel 9½" x 10 mm	1
17-1772	Mixer Forceps Rt Ang 7¼"	4	40-6715	Hibbs Chisel 9½" x 13 mm	1
17-2055	Kelly Forceps Str 5½"	12	40-7400	Key Elevator 7½" x ¼"	1
17-2155	Kelly Forceps Cvd 5½"	12	40-7402	Key Elevator 7½" x ½"	1
17-2272	Roch-Pean Forceps Cvd 7¼"	3	40-9365	Sayre Elevator Blunt D/E 6½"	1
17-2472	Roch-Pean Forceps Str 7¼"	3	42-1765	Weitlaner-Beckman Retractor Sh 6"	1
19-1055	Dressing Forceps 5½"	2	42-1965	Weitlaner Retractor Sh 3x4 6½"	1
19-1080	Dressing Forceps 8"	2	47-2935	Backhaus Towel Clamp 3½"	4
19-1255	Tissue Forceps 1x2 5½"	2	47-2955	Backhaus Towel Clamp 5¼"	12
19-1280	Tissue Forceps 1x2 8"	2	50-2008	Frazier Suction Tube 8 Fr	1
21-8032	Mayo-Hegar Nh Serr 7" T-C	1	50-2010	Frazier Suction Tube 10 Fr	1
21-8033	Mayo-Hegar Nh Serr 8" T-C	1	50-2012	Frazier Suction Tube 12 Fr	1
36-2160	Allis Tissue Forceps 4x5 6"	2	55-7175	Hibbs Retractor 2" x 5/8" Bld 7½"	2
36-2275	Allis Tissue Forceps 5x6 7½"	2	60-6162	Senn Retractor D/E Sharp 6¼"	2
40-1775	Needle Nose Pliers 5½"	1	60-6164	Senn Retractor D/E Blunt 6¼"	2
40-2275	Bone/Cartilage Clamp Cvd 8"	1	75-5670	Metzenbaum Scissors Cvd 7"	1
40-2480	Kern Bone Forceps w/o Ratchet Xsm 5¾"	1			

Sklar Offers Special Pricing on Sets

Laminectomy Set (98-1032)

Number	Description	Qty.	Number	Description	Qty.
98-1032	Complete Set		87-2195	Foerster Sponge Forceps Str Serr 9½"	6
06-2903	Scalpel Handle #3	1	42-3418	Love-Kerrison Rongeur 6" Upbite 5 mm	1
06-2904	Scalpel Handle #4	1	42-3429	Love-Kerrison Rongeur 6" Downbite 5 mm	1
06-2907	Scalpel Handle #7	1	42-3150	Love-Gruenwald Rongeur 6" 2 x 10 mm	1
15-1567	Mayo Scissors Straight 6¾"	1	42-3156	Love-Gruenwald Rongeur Str 7" 3 x 10 mm	1
15-2567	Mayo Scissors Curved 6¾"	1	42-3158	Love-Gruenwald Rongeur Upbite 7" 3 x 10 mm	1
75-5570	Metzenbaum Scissors Curved 7"	1	42-3160	Love-Gruenwald Rongeur Downbite 7" 3 x 10 mm	1
14-1055	Operating Scissors S/B Straight 5½"	1	40-7000	Spinal Curettes 8" 000	1
14-2055	Operating Scissors S/B Curved 5½"	1	40-7100	Spinal Curettes 8" 00	1
19-1055	Dressing Forceps 5½"	1	40-7110	Spinal Curettes 8" 0	1
19-1080	Dressing Forceps 8" Serrated	2	40-7111	Spinal Curettes 8" 1	1
19-1255	Tissue Forceps 5½" 1 x 2	1	40-7112	Spinal Curettes 8" 2	1
19-1280	Tissue Forceps 8" 1 x 2	2	40-7113	Spinal Curettes 8" 3	1
22-6770	Cushing Forceps Serrated 7"	1	40-7114	Spinal Curettes 8" 4	1
22-6870	Cushing Forceps 1 x 2 7"	1	40-7115	Spinal Curettes 8" 5	1
50-3371	Adson Bayonet Forceps 7½" Serrated	1	40-7116	Spinal Curettes 8" 6	1
17-1450	Halsted Straight 5"	12	40-3670	Luer Rongeur Curved	1
17-1550	Halsted Curved 5"	12	40-4092	Leksell Rongeur Std Wide	1
17-3062	Crile Straight 6¼"	12	40-3910	Horsley Rongeur D/A Angular	1
17-3162	Crile Curved 6¼"	12	40-3985	Stille Luer Rongeur Straight	1
36-2260	Allis Tissue Forceps 5 x 6 6"	4	40-4090	Stille Luer Rongeur Angular	1
57-1322	Beckman-Adson Retractor Sharp	2	40-3710	Stille Liston Bone Cutter Straight	1
42-1975	Weitlaner Retractor 8" Sharp	2			
47-2955	Backhaus Towel Clamp 5¼"	12			

**New Hospital Sets Come With
30 Days Extra Dating!**



Basic Eye Surgery Set (98-1034)

Number	Description	Qty.
98-1034	Complete Set	
06-2903	Scalpel Handle #3	1
06-2907	Scalpel Handle #7	1
64-1342	Stevens Tenotomy Scissors Curved Blunt 4½"	1
64-1242	Stevens Tenotomy Scissors Straight Blunt 4½"	1
47-1235	Iris Scissors Straight 3½"	1
47-1135	Iris Scissors Straight 4½"	1
47-1245	Iris Scissors Curved 4½"	1
18-1050	Halsted Mosquito Forceps Straight 5" Delciate	2
18-1150	Halsted Mosquito Forceps Curved 5" Delciate	4
64-3290	Castroviejo Scissors Corneal Right 4½"	1
64-3292	Castroviejo Scissors Corneal Left 4½"	1
65-6357	T-C Castroviejo Needle Holder Straight W/Lock	1
66-2740	Eye Dressing Forceps Serrated Straight 4"	1
66-2940	Eye Dressing Forceps Serrated Straight 4"	1
66-3340	Eye Dressing Forceps 1 x 2 Straight 4"	1
66-3540	Eye Dressing Forceps 1 x 2 ½ Curved 4"	1
66-5340	Arruga Capsule Forceps.....	1
65-1535	Castroviejo Eye Speculum	1
65-1532	Lancaster Eye Speculum.....	1
65-1842	Demarres Lid Retractor #2	1
47-2955	Backhaus Towel Clamps 3½"	1

Tonsil Set (98-1036)

Number	Description	Qty.
98-1036	Complete Set	
75-5570	Metzenbaum Scissors Curved 7"	1
15-2567	Mayo Scissors Curved 6¾"	1
75-1015	Jennings Mouth Gag Small	1
75-1016	Jennings Mouth Gag Medium.....	1
75-1017	Jennings Mouth Gag Large	1
36-2275	Allis Tissue Forceps 7½"	1
07-1801	Yankauer Suction Tube	1
74-2575	Tonsil Forceps White 7½"	2
75-2160	Wieder Tongue Depressor Small.....	1
75-2161	Wieder Tongue Depressor Large.....	1
74-3075	Schmidt Tonsil Hemostats	2
75-6387	Hurd Dissector & Pillar Retractor.....	1

Number	Description	Qty.
17-2262	Rochester-Pean Forceps Curved 6¼".....	2
06-2907	Scalpel Handle #7	1
47-2955	Backhaus Towel Clamps 5½"	1
87-2195	Sponge Forceps Serrated Straight 9½".....	1
20-1270	Crile Wood Needle Holder 7"	1
75-9612	Hartman Tonsil Punch	1
75-2320	Love Urula Retractor	1
75-9070	Eves Tonsil Snare.....	1
75-9245	Tyding Tonsil Snare	1

Myringotomy Set (98-1038)

Number	Description	Qty.
98-1038	Complete Set	
47-1145	Iris Scissors Straight Sharp/Sharp.....	1
68-1765	Applicator Twist End 6½"	1
68-1865	Applicator Triangle End 6½"	1
67-2005	Ear Knife.....	1
67-6010	Boucheron Ear Speculum Set of 4	1
67-6025	Boucheron Ear Speculum Infant.....	1
50-1953	Baron Suction Tube 3 Fr	1
50-1955	Baron Suction Tube 5 Fr	1
50-1957	Baron Suction Tube 7 Fr	1
67-1150	Wilde Ear Forceps Delicate 5"	1
67-2515	Buck Ear Curette Straight Sharp #0	1
67-2516	Buck Ear Curette Straight Sharp #1	1
67-2490	Buck Ear Curette Straight Blunt #0.....	1
67-2491	Buck Ear Curette Straight Blunt #1.....	1
67-1036	Hartman Ear Forceps Delicate 3½"	1

06-1000.....	499	06-3103.....	208	07-1806.....	117	10-1707.....	507
06-1003.....	499	06-3104.....	208	10-1080.....	504	10-1708.....	507
06-1004.....	499	06-3105.....	208	10-1111.....	504	10-1710.....	506
06-1101.....	499	06-3106.....	208	10-1180.....	504	10-1711.....	506
06-1201.....	500	06-3107.....	208	10-1211.....	504	10-1712.....	506
06-1202.....	500	06-3110.....	208	10-1280.....	504	10-1714.....	506
06-1210.....	500	06-3111.....	208	10-1312.....	504	10-1716.....	507
06-1301.....	500	06-3112.....	208	10-1602.....	511,518,524	10-1717.....	507
06-1701.....	500	06-3115.....	208	10-1603.....	511,518,524	10-1720.....	506
06-1801.....	500	06-3120.....	208	10-1604.....	511,518,524	10-1725.....	506
06-1901.....	500	06-3121.....	208	10-1606.....	513,520,524	10-1729.....	507
06-1906.....	500	06-3122.....	208	10-1607.....	513,520,524	10-1731.....	507
06-1935.....	500	06-3123.....	208	10-1608.....	513,520,524	10-1732.....	507
06-2502.....	499	06-3170.....	497	10-1612.....	513,521,524	10-1733.....	507
06-2503.....	499	06-3175.....	497	10-1613.....	513,521,524	10-1734.....	507
06-2606.....	499	06-3290.....	497	10-1614.....	513,521,524	10-1736.....	507
06-2607.....	499	06-3370.....	497	10-1618.....	521,525	10-1765.....	505
06-2629.....	499	06-3375.....	497	10-1619.....	521,525	10-1770.....	505
06-2631.....	499	06-4100.....	317,495	10-1620.....	521,525	10-1775.....	505
06-2808.....	498	06-4110.....	317,496	10-1622.....	525	10-1776.....	505
06-2852.....	497	06-4112.....	281	10-1626.....	514,521,525	10-1780.....	505
06-2860.....	174,498	06-4113.....	281	10-1629.....	514,521,525	10-1800.....	505
06-2861.....	498	06-4114.....	281	10-1630.....	513,520,524	10-1805.....	505
06-2865.....	498	06-4115.....	281	10-1631.....	513,520,524	10-1808.....	505
06-2870.....	509	06-4120.....	495	10-1632.....	513,520,524	10-1810.....	505
06-2872.....	509	06-4121.....	495	10-1635.....	514,521,525	10-1812.....	505
06-2873.....	509	06-4122.....	495	10-1636.....	514,521,525	10-1816.....	505
06-2880.....	509	06-4125.....	495	10-1640.....	497,529	10-1818.....	505
06-2881.....	509	06-4126.....	495	10-1641.....	497,529	10-1828.....	505
06-2882.....	509	06-4128.....	495	10-1643.....	517,519,525	10-1830.....	505
06-2903.....	208	06-4130.....	281,496	10-1650.....	509,514	10-1832.....	505
06-2904.....	208	06-4131.....	281,496	10-1651.....	509,514	10-1836.....	505
06-2907.....	208	06-4132.....	281,496	10-1652.....	509,514	10-1838.....	505
06-2910.....	208	06-4133.....	281,496	10-1653.....	517,519,525	10-1850.....	507
06-2915.....	208	06-4134.....	281,496	10-1657.....	509,514	10-1852.....	507
06-2920.....	208	06-4135.....	281,496	10-1658.....	509,514	10-1860.....	507
06-2925.....	208	06-4136.....	281,496	10-1659.....	508,514	10-1862.....	507
06-2930.....	208	06-4138.....	281,496	10-1660.....	509	10-1864.....	507
06-2950.....	209	06-4139.....	281,496	10-1661.....	509	10-1965.....	508
06-2955.....	209	06-4140.....	281,496	10-1663.....	509	10-1966.....	508
06-2960.....	209	06-4141.....	281,496	10-1664.....	509	10-1967.....	508
06-2965.....	209	06-4142.....	317,495	10-1665.....	509	10-2701.....	513,520,524
06-2970.....	209	06-4143.....	317,495	10-1666.....	509	10-2705.....	513,520,524
06-2975.....	209	06-4144.....	317,495	10-1668.....	509	10-2730.....	513,520,524
06-2980.....	209	06-4145.....	317,495	10-1669.....	509	10-2755.....	513,520,524
06-2985.....	209	06-4146.....	317,495	10-1670.....	508	10-2760.....	517,519,525
06-2990.....	209	06-4147.....	317,495	10-1671.....	508	10-2762.....	517,519,525
06-2992.....	209	06-4148.....	317,495	10-1672.....	509	10-2763.....	525
06-2995.....	209	06-4150.....	496	10-1675.....	508	10-2770.....	512,520,524
06-3045.....	208	06-4151.....	496	10-1684.....	508	10-2775.....	512,520,524
06-3048.....	208	06-4152.....	496	10-1685.....	508	10-2777.....	512,520,524
06-3050.....	208	06-4153.....	496	10-1686.....	508	10-2780.....	513,520,524
06-3052.....	208	06-4157.....	496	10-1687.....	508	10-2790.....	527
06-3054.....	208	06-4160.....	496	10-1688.....	508	10-2792.....	527
06-3056.....	208	06-4161.....	496	10-1690.....	508	10-2794.....	527
06-3058.....	208	06-6208.....	505	10-1691.....	508	10-2800.....	526
06-3060.....	208	06-6209.....	505	10-1692.....	508	10-2802.....	526
06-3062.....	208	07-1562.....	65	10-1693.....	508	10-2804.....	526
06-3064.....	208	07-1563.....	65	10-1694.....	508	10-2806.....	526
06-3082.....	209	07-1565.....	65,504	10-1698.....	508	11-1035.....	26
06-3083.....	209	07-1570.....	65,504	10-1699.....	508	11-1045.....	26
06-3084.....	209	07-1777.....	65	10-1700.....	507	11-1055.....	26
06-3085.....	209	07-1780.....	65	10-1701.....	507	11-1060.....	27
06-3086.....	209	07-1797.....	65	10-1702.....	507	11-1072.....	26
06-3100.....	208	07-1801.....	117	10-1703.....	507	11-1080.....	26
06-3101.....	208	07-1802.....	117	10-1705.....	506	11-1152.....	27
06-3102.....	208	07-1805.....	117	10-1706.....	507	11-1180.....	28,259,290



11-1252	27	15-1360	19	16-1505	34	17-2480	43
11-1255	27	15-1555	9,305,323	16-1510	34	17-2655	44
11-1257	27	15-1567	9,305,323	16-1515	34	17-2662	44
11-1278	28,259	15-1655	12,305,323	16-1605	34	17-2672	44
11-1280	28,259	15-1667	12,305,323	16-1610	34	17-2680	44
11-1295	256,292	15-1762	12,305	16-1615	34	17-2762	44
11-1297	257,292	15-1862	12	16-1805	35	17-2855	44
11-1298	27,257,292	15-2045	7	16-1810	35	17-2862	44
11-1380	257,292	15-2050	7	16-1905	35	17-2872	44
11-1390	257,292	15-2055	7	16-1910	35	17-2880	44
11-1490	257,292	15-2060	7,322	16-2005	35	17-2957	64,383
11-1525	256	15-2065	7,322	16-2010	35	17-2958	64,383
11-1530	256	15-2307	12,306,323	16-2105	35	17-2962	44
11-1540	256,291	15-2308	12,306,323	16-2110	35	17-3055	40
11-1545	256	15-2445	22	16-2115	35	17-3062	40
11-1546	256	15-2455	22	16-2210	35	17-3075	40
11-1547	256	15-2460	12	16-2310	35	17-3155	40
11-1550	258	15-2470	12	16-2311	35	17-3162	40
11-1610	258	15-2555	9,305,323	16-2405	35	17-3175	40
11-1615	258	15-2567	9,305,323	16-2505	35	17-3255	45
11-1812	259	15-2655	12,305,323	16-2605	35	17-3265	44
11-1910	159,291	15-2667	12,305,323	16-2610	35	17-3275	44
11-1990	259,291	15-2762	12,305	16-2705	35	17-3355	45
11-1995	258,291	15-2862	12	16-2800	28,35,119,251,290	17-3365	44
11-2095	258,291	15-3107	29	16-2820	257	17-3375	44
11-2098	258	15-3150	24	16-3552	34	17-3455	44
11-2100	256,291	15-3172	30,124	16-3557	34	17-3555	44
11-2101	256,291	15-3210	30	16-3562	34	17-3562	65,334,383
11-2105	256,291	15-3306	37	16-3567	34	17-3660	382
11-2110	256,291	15-3310	37	17-1055	64,124,303	17-3955	86
11-2115	256,291	15-3311	37	17-1062	44	17-3960	86
12-1065	250	15-3315	37	17-1080	44	17-3962	86
13-1045	6	15-3320	32	17-1155	45	17-3965	86
13-1050	6	15-3325	37	17-1162	44	17-3970	86
13-1055	6,322	15-3326	37	17-1180	44	17-3980	86
13-1060	6,322	15-3330	37	17-1220	47	17-3995	86
13-1065	6,322	15-3331	37	17-1225	47	17-3996	86
13-1155	8	15-3342	36	17-1230	42	17-3997	86
13-2045	7	15-3343	36	17-1232	42	18-1050	39
13-2050	7	15-3349	36	17-1235	42	18-1150	39
13-2055	7,322	15-3352	37	17-1255	45	18-1250	46,303
13-2060	7,322	15-3357	37	17-1260	47	18-1352	45
13-2065	7,322	15-3410	37	17-1262	44	18-1452	45
13-2155	8	15-3426	37	17-1335	42	18-1552	41
14-1045	6	15-3442	36	17-1355	45	18-1652	41
14-1050	6	15-3443	36	17-1360	47	18-1752	44
14-1055	6,322	15-3448	36	17-1450	38	18-1852	44
14-1060	6,322	15-3449	36	17-1550	38	18-1952	40
14-1065	6,322	15-3452	37	17-1650	38	18-2052	40
14-1155	8	15-3457	37	17-1750	38	18-2140	63,284,327
14-2045	7	15-3500	33	17-1762	46,303	18-2155	63,284,327
14-2050	7	15-3505	33	17-1772	46,124,303	18-2162	63,284,327
14-2055	7,322	15-3510	33	17-1775	49	18-2164	63,284,327
14-2060	7,322	15-3515	33	17-1855	45	18-2257	64
14-2065	7,322	15-3542	32	17-1955	45	19-1045	70
14-2155	8	15-3550	33	17-2055	41	19-1050	70
15-1045	6	15-3555	33	17-2155	41	19-1055	70
15-1050	6	15-3560	33	17-2255	43	19-1060	70
15-1055	6	15-3565	33	17-2262	43	19-1080	70
15-1060	6	15-3570	33	17-2267	43	19-1110	70
15-1065	6	15-3575	33	17-2272	43	19-1112	70
15-1155	8	15-3585	33	17-2280	43	19-1245	71
15-1282	29,306	15-3590	33	17-2362	43	19-1250	71
15-1285	29,306	16-1055	34	17-2455	43	19-1255	71
15-1307	12,306,323	16-1056	34	17-2462	43	19-1260	71
15-1308	12,306,323	16-1057	34	17-2467	43	19-1280	71
15-1355	23,151	16-1156	34	17-2472	43	19-1310	71

19-1312.....	71	20-3075.....	90,325	21-8046.....	97	22-2760.....	19
19-1450.....	72	20-3910.....	89	21-8055.....	97	22-2820.....	25
19-1455.....	72	20-4170.....	89	21-8058.....	97	22-2822.....	25
19-1460.....	72	20-4175.....	395	21-8060.....	96	22-2824.....	25
19-1480.....	72	20-4178.....	395	21-8061.....	96	22-2825.....	25
19-1510.....	72	20-4510.....	90,324	21-8062.....	98,325	22-2834.....	23
19-1512.....	72	20-4610.....	90	21-8064.....	98,325	22-2835.....	23,151
19-1655.....	72	20-4682.....	90,325	21-8065.....	96,324	22-2844.....	23
19-1660.....	72	20-4795.....	324	21-8070.....	98	22-2845.....	23,151
19-1855.....	72	20-4852.....	88	21-8071.....	98,325	22-2934.....	24
19-1910.....	72	20-4867.....	88	21-8075.....	94	22-2935.....	24,151
19-1950.....	72	21-1260.....	92	21-8078.....	98,325	22-2947.....	24,151
19-1955.....	72	21-1450.....	93	21-8080.....	94,95	22-2950.....	24
19-1975.....	72	21-1547.....	92	21-9016.....	99	22-2955.....	21
19-2050.....	72	21-1650.....	92	21-9018.....	99	22-3047.....	45
19-2170.....	73,334	21-1652.....	92	21-9030.....	99	22-3147.....	45
19-2260.....	73	21-1750.....	93	21-9035.....	99	22-3255.....	46,124
19-2280.....	73	21-1850.....	93	21-9045.....	99	22-3270.....	46,124
19-2310.....	73	21-2060.....	93	21-9060.....	433	22-3555.....	43
19-2460.....	72	21-2070.....	93	21-9065.....	433	22-3655.....	43
19-2860.....	73	21-2480.....	93	22-1054.....	26	22-3755.....	44
19-2880.....	73	21-2570.....	93	22-1057.....	10	22-3855.....	44
19-2910.....	73	21-2910.....	93	22-1063.....	71	22-4150.....	73
19-2925.....	74,283	21-3510.....	93	22-1070.....	11,190,322,431	22-4250.....	73
19-2926.....	74,283,290	21-4170.....	93	22-1071.....	11,190,431	22-4350.....	73
19-2930.....	81,493	21-4682.....	93	22-1072.....	26	22-4450.....	73
19-2945.....	81,493	21-4970.....	93	22-1135.....	15,150	22-4550.....	73
19-3030.....	81,493	21-4992.....	93	22-1145.....	6	22-4650.....	73
19-3035.....	81,493	21-5112.....	93	22-1150.....	6	22-5050.....	89
19-3040.....	81,493	21-8000.....	95	22-1155.....	6	22-6155.....	65,329
19-3045.....	81,493	21-8001.....	95	22-1161.....	70	22-6157.....	63,284
19-3050.....	494	21-8002.....	94	22-1162.....	70	22-6162.....	64
19-3055.....	494	21-8004.....	94	22-1163.....	70	22-6260.....	51
19-3147.....	494	21-8005.....	95	22-1164.....	70	22-6457.....	52
19-3160.....	494	21-8006.....	95	22-1235.....	15,150	22-6557.....	52
19-3162.....	494	21-8007.....	95	22-1240.....	16,148	22-6577.....	117
19-3240.....	81,493	21-8008.....	95	22-1241.....	16,148	22-6585.....	117
19-3340.....	81,493	21-8009.....	95	22-1242.....	16,148	22-6586.....	117
19-3350.....	81,493	21-8010.....	95	22-1245.....	6	22-6770.....	69
19-3360.....	81,493	21-8011.....	95	22-1250.....	6	22-6870.....	69
20-1260.....	88	21-8012.....	95	22-1255.....	6	22-7470.....	73
20-1265.....	89	21-8013.....	95	22-1342.....	16,148	22-7560.....	387
20-1270.....	89,324	21-8014.....	95	22-1350.....	6	22-7660.....	387
20-1280.....	89,324	21-8016.....	95	22-1354.....	23	22-7760.....	387
20-1290.....	89,324	21-8020.....	95	22-1442.....	17,153	22-7795.....	116,389
20-1295.....	89,324	21-8022.....	95	22-1445.....	7	22-7822.....	118
20-1350.....	88,324	21-8023.....	95	22-1450.....	7	22-7855.....	104,386
20-1352.....	88,324	21-8025.....	96	22-1455.....	7	22-7875.....	386
20-1450.....	88	21-8026.....	96	22-1542.....	17,153	22-8067.....	108
20-1547.....	88	21-8027.....	96	22-1550.....	7	22-8075.....	108
20-1750.....	88	21-8028.....	96	22-1556.....	9	22-8080.....	108
20-1751.....	88	21-8029.....	96	22-1567.....	9	22-8180.....	108
20-1760.....	169,492	21-8030.....	95	22-1650.....	7	22-8210.....	113
20-1870.....	89	21-8031.....	95	22-2272.....	43	22-8211.....	113
20-2052.....	89	21-8032.....	95	22-2280.....	43	22-8212.....	113
20-2060.....	89	21-8033.....	95	22-2450.....	10,190	22-8213.....	113
20-2070.....	89,324	21-8034.....	95	22-2460.....	10,190	22-8214.....	113
20-2270.....	89	21-8035.....	95	22-2520.....	19	22-8215.....	113
20-2480.....	89,324	21-8036.....	96	22-2545.....	10	22-8245.....	100
20-2747.....	89,169	21-8037.....	96	22-2550.....	10	22-8255.....	100
20-2748.....	169	21-8038.....	96	22-2555.....	9	22-8270.....	106
20-2755.....	89	21-8039.....	96	22-2567.....	9	22-8345.....	100
20-2765.....	89,324	21-8040.....	97	22-2650.....	10	22-8355.....	100
20-2775.....	89,324	21-8042.....	97	22-2652.....	21	22-8360.....	105,196
20-2910.....	89,324	21-8043.....	97	22-2742.....	13	22-8460.....	105,196
20-2911.....	89	21-8044.....	97	22-2745.....	22	22-8560.....	106
20-3055.....	90	21-8045.....	97	22-2755.....	323	22-8832.....	101



22-8834	101	23-1182	11,465	23-2606	67,473	25-9762	261
22-8850	100	23-1184	11,465	23-2608	67,473	25-9780	261
22-8853	100	23-1186	11,465	23-2811	71,473	25-9785	261
22-8855	100	23-1188	23,151,466	23-2819	71,473	25-9786	261
22-8860	105	23-1189	23,151,466	23-2824	70,474	26-1280	120,283
22-8920	101	23-1190	23,151,466	23-2826	70,474	26-1380	120,283
22-8940	101	23-1191	24,151,466	23-2828	70,474	26-1480	120,283
22-8945	197	23-1193	23,466	23-2830	70,474	26-1580	120,283
22-9027	101	23-1194	23,466	23-2834	70,474	26-1640	283
22-9030	102	23-1195	23,466	23-2836	70,474	30-1045	121
22-9132	111,205	23-1196	24,466	23-2838	70,474	30-1050	121
22-9133	111,205	23-1199	26,467	23-2840	474	30-1055	121
22-9142	111,205	23-1200	26,467	23-2851	62,284,474	30-1060	121
22-9143	111,205	23-1202	26,467	23-2852	62,474	30-1070	121
22-9155	204	23-1203	26,467	23-2861	63,474	30-1080	121
22-9380	86,504	23-1250	32,467	23-2862	63,474	30-1145	121
22-9480	86,504	23-1254	32,467	23-2864	63,474	30-1150	121
23-1100	6,462	23-1260	33,468	23-2865	63,474	30-1155	121
23-1101	6,462	23-1262	33,468	23-9250	265	30-1160	121
23-1102	6,462	23-1266	33,468	23-9251	260	30-1170	121
23-1104	6,462	23-1268	33,468	23-9255	260	30-1180	121
23-1105	6,462	23-1270	33,468	23-9259	260	30-1350	122
23-1106	6,462	23-1274	33,468	23-9273	260	30-1380	122
23-1112	6,462	23-1278	33,468	23-9275	260	30-1450	122
23-1113	6,462	23-1280	33,468	23-9276	260	30-1545	121
23-1114	6,462	23-1290	25	23-9292	264	30-1550	121
23-1116	6,462	23-1292	25	24-1014	119	30-1555	121
23-1118	6,462	23-1294	25	24-1016	119	30-1560	121
23-1124	7,462	23-1296	25	24-1018	119	30-1580	121
23-1126	7,462	23-1300	25	24-1112	120	30-1610	121
23-1130	7,462	23-1302	25	24-1114	120	30-1612	121
23-1138	7,462	23-1304	25	24-1116	120	30-1945	121
23-1140	7,462	23-1306	25	24-1118	120	30-1950	121
23-1142	7,462	23-2100	42,469	24-1120	120	30-1955	121
23-1148	14,150,463	23-2101	42,469	24-1150	83	30-1960	121
23-1149	14,150,463	23-2105	38,469	24-1250	119	30-1980	121
23-1150	14,150,463	23-2106	38,469	24-1350	83,120	30-2010	121
23-1151	14,150,463	23-2107	41,470	24-1450	83,120	30-2012	121
23-1152	15,150,463	23-2108	41,470	24-1650	83,120	30-2145	121
23-1153	15,150,463	23-2110	40,470	24-1962	28	30-2150	121
23-1154	15,150,463	23-2113	40,470	24-2055	119	30-2155	121
23-1155	15,150,463	23-2500	42,469	24-2155	83,119	30-2160	121
23-1156	16,148,464	23-2501	42,469	24-2220	120,290	30-2212	121
23-1157	16,148,464	23-2505	39,469	24-2222	120,290	30-2580	122
23-1158	17,153,463	23-2506	39,469	24-2224	120,290	30-2680	122
23-1159	17,153,463	23-2507	41,470	24-2226	120,290	31-2205	450
23-1160	16,148,464	23-2508	41,470	24-2228	120,290	31-2210	449
23-1161	16,148,464	23-2510	40,470	24-2230	120,290	31-2212	449
23-1162	17,153,463	23-2513	40,470	24-2232	120,290	31-2215	447
23-1163	17,153,463	23-2516	46,471	24-2340	28,290	31-2220	447
23-1164	9,305,464	23-2520	46,471	24-2341	28,290	31-2222	447
23-1165	9,305,464	23-2521	46,471	24-2342	28,119,251,290	31-2225	447
23-1166	9,305,464	23-2525	46,471	24-2345	28,290	31-2230	447
23-1167	9,305,464	23-2532	43,472	24-2346	28,290	31-2232	447
23-1168	9,464	23-2538	43,472	24-2347	23,119,290	31-2234	447
23-1169	9,464	23-2542	43,472	25-9005	335	31-2236	447
23-1170	9,464	23-2552	43	25-9010	336	31-2240	452
23-1171	9,464	23-2560	44,472	25-9015	337	31-2246	452
23-1172	10,465	23-2561	43,472	25-9020	338	31-2248	452
23-1173	10,465	23-2563	43,472	25-9025	339	31-2250	452
23-1174	10,465	23-2568	44,472	25-9030	340	31-2255	448
23-1175	10,465	23-2577	472	25-9035	341	31-2260	448
23-1176	10,465	23-2585	472	25-9040	342	31-2264	448
23-1177	10,465	23-2600	66,473	25-9042	342	31-2305	451
23-1178	10,465	23-2602	66,473	25-9751	261	31-2310	450
23-1179	10,465	23-2603	66,473	25-9755	261	31-2320	450
23-1180	11,465	23-2604	67,473	25-9759	261	31-2325	450

31-2328.....	450	31-2544F.....	436	31-2574E.....	438	31-2604D.....	439
31-2330.....	450	31-2544G.....	436	31-2574F.....	438	31-2620A.....	440
31-2335.....	450	31-2544H.....	436	31-2574G.....	438	31-2620B.....	440
31-2338.....	450	31-2550B.....	437	31-2574H.....	438	31-2620C.....	440
31-2340.....	451	31-2550C.....	437	31-2576A.....	438	31-2620D.....	440
31-2345.....	451	31-2550D.....	437	31-2576B.....	438	31-2622A.....	440
31-2348.....	451	31-2550E.....	437	31-2576C.....	438	31-2622C.....	440
31-2350.....	450	31-2550F.....	437	31-2576D.....	438	31-2624A.....	440
31-2352.....	450	31-2550G.....	437	31-2578A.....	438	31-2624B.....	440
31-2355.....	449	31-2550H.....	437	31-2578B.....	438	31-2624C.....	440
31-2360.....	451	31-2552B.....	437	31-2578C.....	438	31-2624D.....	440
31-2362.....	451	31-2552C.....	437	31-2578D.....	438	31-2626A.....	440
31-2364.....	451	31-2552D.....	437	31-2580A.....	438	31-2626C.....	440
31-2365.....	449	31-2552E.....	437	31-2580B.....	438	31-2626E.....	440
31-2530B.....	436	31-2552F.....	437	31-2580C.....	438	31-2626F.....	440
31-2530C.....	436	31-2552G.....	437	31-2580D.....	438	31-2626G.....	440
31-2530D.....	436	31-2552H.....	437	31-2582A.....	438	31-2626H.....	440
31-2530E.....	436	31-2554B.....	437	31-2582B.....	438	31-2628A.....	440
31-2530F.....	436	31-2554C.....	437	31-2582C.....	438	31-2630A.....	440
31-2530G.....	436	31-2554D.....	437	31-2582D.....	438	31-2630C.....	440
31-2530H.....	436	31-2554E.....	437	31-2584E.....	438	31-2630E.....	440
31-2532B.....	436	31-2554F.....	437	31-2590B.....	439	31-2630F.....	440
31-2532C.....	436	31-2554G.....	437	31-2590C.....	439	31-2630G.....	440
31-2532D.....	436	31-2554H.....	437	31-2590D.....	439	31-2630H.....	440
31-2532E.....	436	31-2556A.....	437	31-2590E.....	439	31-2632A.....	440
31-2532F.....	436	31-2558B.....	437	31-2590F.....	439	31-2632B.....	440
31-2532G.....	436	31-2558C.....	437	31-2590G.....	439	31-2634A.....	440
31-2532H.....	436	31-2558D.....	437	31-2590H.....	439	31-2634C.....	440
31-2534B.....	436	31-2558E.....	437	31-2592B.....	439	31-2634E.....	440
31-2534C.....	436	31-2558F.....	437	31-2592C.....	439	31-2634F.....	440
31-2534D.....	436	31-2558G.....	437	31-2592D.....	439	31-2634G.....	440
31-2534E.....	436	31-2558H.....	437	31-2592E.....	439	31-2634H.....	440
31-2534F.....	436	31-2560B.....	437	31-2592F.....	439	31-2640A.....	441
31-2534G.....	436	31-2560C.....	437	31-2592G.....	439	31-2640C.....	441
31-2534H.....	436	31-2560D.....	437	31-2592H.....	439	31-2640E.....	441
31-2536B.....	436	31-2560E.....	437	31-2594B.....	439	31-2640F.....	441
31-2536C.....	436	31-2560F.....	437	31-2594C.....	439	31-2640G.....	441
31-2536D.....	436	31-2560G.....	437	31-2594D.....	439	31-2640H.....	441
31-2536E.....	436	31-2560H.....	437	31-2594E.....	439	31-2642E.....	441
31-2536F.....	436	31-2562B.....	437	31-2594F.....	439	31-2642F.....	441
31-2536G.....	436	31-2562C.....	437	31-2594G.....	439	31-2642G.....	441
31-2536H.....	436	31-2562D.....	437	31-2594H.....	439	31-2644E.....	441
31-2538B.....	436	31-2562E.....	437	31-2596A.....	439	31-2644F.....	441
31-2538C.....	436	31-2562F.....	437	31-2596B.....	439	31-2644G.....	441
31-2538D.....	436	31-2562G.....	437	31-2596C.....	439	31-2646B.....	441
31-2538E.....	436	31-2562H.....	437	31-2596D.....	439	31-2646D.....	441
31-2538F.....	436	31-2564B.....	437	31-2598B.....	439	31-2648E.....	441
31-2538G.....	436	31-2564C.....	437	31-2598C.....	439	31-2648F.....	441
31-2538H.....	436	31-2564D.....	437	31-2598D.....	439	31-2648G.....	441
31-2540B.....	436	31-2564E.....	437	31-2598E.....	439	31-2650B.....	441
31-2540C.....	436	31-2564F.....	437	31-2598F.....	439	31-2650D.....	441
31-2540D.....	436	31-2564G.....	437	31-2598G.....	439	31-2652E.....	441
31-2540E.....	436	31-2564H.....	437	31-2598H.....	439	31-2652F.....	441
31-2540F.....	436	31-2570B.....	438	31-2600A.....	439	31-2652G.....	441
31-2540G.....	436	31-2570C.....	438	31-2600B.....	439	31-2654B.....	441
31-2540H.....	436	31-2570D.....	438	31-2600C.....	439	31-2654D.....	441
31-2542B.....	436	31-2570E.....	438	31-2600D.....	439	31-4452.....	442
31-2542C.....	436	31-2570F.....	438	31-2602B.....	439	31-4454.....	442
31-2542D.....	436	31-2570G.....	438	31-2602C.....	439	31-4456.....	442
31-2542E.....	436	31-2570H.....	438	31-2602D.....	439	31-4458.....	442
31-2542F.....	436	31-2572A.....	438	31-2602E.....	439	31-4460.....	442
31-2542G.....	436	31-2572B.....	438	31-2602F.....	439	31-4462.....	442
31-2542H.....	436	31-2572C.....	438	31-2602G.....	439	31-4464.....	442
31-2544B.....	436	31-2572D.....	438	31-2602H.....	439	31-4500.....	443
31-2544C.....	436	31-2574B.....	438	31-2604A.....	439	31-4502.....	443
31-2544D.....	436	31-2574C.....	438	31-2604B.....	439	31-4504.....	443
31-2544E.....	436	31-2574D.....	438	31-2604C.....	439	31-4506.....	443



31-4508.....	443	32-1215.....	125	36-2160.....	62,284	40-1640.....	254
31-4510.....	443	32-1218.....	125	36-2260.....	62,284	40-1642.....	254
31-4512.....	443	32-1220.....	125	36-2275.....	62,284,327	40-1644.....	254
31-4514.....	443	32-1530.....	123	36-2295.....	62,284,327	40-1645.....	254
31-4520.....	444	32-1533.....	123	36-2298.....	56,284,327	40-1650.....	286
31-4522.....	444	32-1534.....	123	36-2380.....	61	40-1715.....	251,287
31-4524.....	444	32-1535.....	123	36-2385.....	56,327	40-1716.....	251,287
31-4526.....	444	32-1536.....	123	36-2577.....	64,126	40-1720.....	252,288
31-4528.....	444	32-1537.....	123	36-2595.....	64,126	40-1725.....	252,289
31-4530.....	444	32-1538.....	123	36-2607.....	126	40-1730.....	252
31-4534.....	444	32-1539.....	123	36-2690.....	43	40-1735.....	252
31-4550.....	442,445	32-1610.....	123	36-2710.....	43	40-1738.....	252
31-4558.....	445	32-1611.....	123	36-2790.....	43	40-1744.....	288
31-4570.....	445	32-1680.....	53	36-2810.....	43	40-1745.....	288
31-4572.....	445	32-1780.....	49,52	36-2880.....	48	40-1750.....	254
31-4574.....	445	32-1785.....	50,123	36-2890.....	48	40-1752.....	254
31-5000.....	446	32-1870.....	50,123	36-2895.....	48	40-1754.....	254
31-5002.....	446	32-1875.....	48,123	36-2962.....	48	40-1762.....	251,289
31-5004.....	446	32-1890.....	48,123	36-2990.....	48	40-1765.....	254
31-5006.....	446	32-1990.....	48,123	36-2995.....	48	40-1766.....	254
31-5008.....	446	32-2070.....	48,124	36-3180.....	48	40-1771.....	253
31-5550.....	448	32-2075.....	49,124	36-3195.....	48	40-1775.....	252,287
31-5552.....	448	32-2175.....	49,124	36-3210.....	48	40-1778.....	252,287
31-5554.....	448	32-2465.....	125	36-3310.....	48	40-1780.....	240
31-6050.....	453	32-2470.....	126,384	36-3590.....	48	40-1781.....	240
31-6052.....	453	32-2477.....	126,384	36-3690.....	48	40-1915.....	255,287
31-6054.....	453	32-2782.....	49	36-3790.....	48	40-1916.....	255,287
31-6056.....	453	32-2785.....	49	36-4082.....	48	40-1918.....	255,287
31-6058.....	453	32-2880.....	49	36-4180.....	51	40-1919.....	255,287
31-6060.....	453	32-2980.....	49	36-4280.....	52	40-2085.....	239,258
31-6062.....	453	33-1001.....	49,127	36-4311.....	52	40-2185.....	239,258
31-6064.....	453	33-1002.....	49,127	36-4313.....	52	40-2275.....	239,247,285
31-6066.....	453	33-1003.....	49,127	36-4411.....	51	40-2276.....	247
31-6068.....	453	33-1004.....	49,127	36-4490.....	50	40-2285.....	238
31-6070.....	453	33-1090.....	51,127	36-4590.....	52	40-2290.....	243
31-6072.....	453	33-1190.....	51,127	36-7010.....	52	40-2295.....	243
31-6150.....	454,455	33-1210.....	127	40-1010.....	253	40-2313.....	237
31-6152.....	454,455	33-1290.....	127	40-1012.....	253	40-2413.....	237
31-6155.....	454,455	33-1297.....	50,127	40-1018.....	251	40-2417.....	237
31-6160.....	454	33-1375.....	52,127	40-1023.....	251,289	40-2418.....	237
31-6162.....	454	33-1585.....	51	40-1024.....	251,289	40-2480.....	237,282
31-6164.....	454	34-1014.....	118	40-1045.....	251,289	40-2485.....	237
31-6166.....	454	34-1017.....	118	40-1048.....	251,289	40-2580.....	238,282
31-6168.....	454	34-1410.....	118	40-1465.....	253,286	40-2585.....	238
31-6170.....	454	34-1414.....	118	40-1475.....	253,286	40-2590.....	238
31-6172.....	455	34-1417.....	118	40-1478.....	253,286	40-2595.....	238
31-6174.....	455	34-1420.....	118	40-1515.....	282	40-2598.....	238
31-6176.....	455	34-1424.....	118	40-1520.....	253	40-2640.....	248
31-6178.....	455	34-1428.....	118	40-1530.....	253	40-2642.....	248
31-6180.....	455	34-2023.....	117	40-1535.....	255,286	40-2650.....	240,285
31-6182.....	455	34-2230.....	117	40-1545.....	255,286	40-2655.....	240,285
31-6184.....	455	34-2422.....	118	40-1562.....	255,286	40-2660.....	240,247
31-6190.....	456	34-2428.....	118	40-1565.....	255,286	40-2665.....	248
31-6192.....	456	34-2434.....	118	40-1566.....	255,286	40-2670.....	239,285
31-6194.....	456	34-2438.....	118	40-1567.....	255,286	40-2672.....	239
31-6196.....	456	34-2526.....	118	40-1568.....	255,286	40-2675.....	239,285
31-6198.....	456	34-2536.....	118	40-1569.....	255,286	40-2678.....	240
31-6200.....	456	36-1290.....	73	40-1580.....	255,286	40-2705.....	239
31-6210.....	456	36-1662.....	65,329	40-1582.....	255,286	40-2708.....	238
31-6212.....	456	36-1677.....	65,329	40-1584.....	255,286	40-2710.....	237
31-6214.....	456	36-1692.....	65,329	40-1590.....	255,286	40-2780.....	236
32-1014.....	125	36-1765.....	61	40-1591.....	255,286	40-2810.....	237
32-1016.....	125	36-1860.....	61	40-1592.....	255,286	40-2820.....	237
32-1037.....	125	36-1865.....	64	40-1593.....	255,286	40-2830.....	237
32-1040.....	125	36-1960.....	61	40-1594.....	255,286	40-2835.....	237
32-1124.....	125	36-1975.....	61	40-1595.....	255,286	40-2921.....	236,282
32-1140.....	125	36-2060.....	62,284	40-1596.....	255,286	40-2922.....	236,282

40-2923	236	40-5535	250	40-6550	227,279	40-6774	226
40-2925	238,282	40-5540	250	40-6552	279	40-6775	226
40-2927	236,282	40-5542	250	40-6560	227	40-6776	226
40-2928	236	40-5544	250	40-6561	227	40-6777	226
40-3040	274	40-5546	250	40-6562	227	40-6781	226
40-3055	211,275	40-5665	278	40-6563	227	40-6782	226
40-3077	211,275	40-5672	232,278	40-6564	227	40-6783	226
40-3087	211,275	40-5765	232,278	40-6565	227	40-6784	226
40-3155	211,275	40-5870	232,278	40-6570	227	40-6785	226
40-3177	211,275	40-5871	232,278	40-6571	227	40-6786	226
40-3187	211,275	40-5875	232,278	40-6572	227	40-6787	226
40-3188	218	40-5910	232	40-6573	227	40-6791	226
40-3190	218,277	40-5925	232,278	40-6574	227	40-6792	226
40-3192	218,277	40-5926	232,278	40-6575	227	40-6793	226
40-3196	274	40-5940	232	40-6624	227,279	40-6794	226
40-3198	274	40-6020	230	40-6625	227,279	40-6795	226
40-3200	277	40-6022	230	40-6626	227,279	40-6796	226
40-3202	277	40-6024	230	40-6628	227,279	40-6797	226
40-3206	277	40-6026	230	40-6630	227,279	40-6799	226
40-3208	218	40-6028	230	40-6632	227,279	40-6800	226
40-3480	217	40-6056	230	40-6636	227,279	40-6801	226
40-3570	216	40-6060	230	40-6639	227,279	40-6802	226
40-3670	216	40-6072	230	40-6642	227,279	40-6803	226
40-3710	211	40-6078	230	40-6645	227,279	40-6804	226
40-3810	211	40-6080	230	40-6666	228	40-6805	226
40-3910	212	40-6082	230	40-6667	228	40-6833	228
40-3985	214	40-6084	230	40-6668	228	40-6835	228
40-4085	214	40-6085	230	40-6669	228	40-6836	228
40-4086	213	40-6086	230	40-6670	228	40-6837	228
40-4090	214	40-6088	230	40-6671	228	40-6838	228
40-4092	213	40-6092	230	40-6672	228	40-6839	228
40-4095	212	40-6093	230	40-6673	228	40-6843	228
40-4097	213	40-6094	230	40-6674	228	40-6845	228
40-4098	213	40-6096	230	40-6675	228	40-6846	228
40-4100	212	40-6106	226	40-6680	228	40-6847	228
40-4102	212	40-6112	226	40-6681	228	40-6848	228
40-4104	212	40-6118	226	40-6682	228	40-6849	228
40-4106	212	40-6206	226	40-6683	228	40-6855	241
40-4108	212	40-6212	226	40-6684	228	40-6914	241
40-4110	213	40-6218	226	40-6685	228	40-6920	229
40-4112	213	40-6306	226	40-6686	228	40-6921	229
40-4114	213	40-6312	226	40-6687	228	40-6922	229
40-4120	212	40-6318	226	40-6688	228	40-6923	229
40-4125	214	40-6330	227	40-6689	228	40-6953	228,279
40-4190	215	40-6331	227	40-6701	228	40-6954	228,279
40-4192	215	40-6332	227	40-6711	228	40-6956	228,279
40-4194	215	40-6333	227	40-6715	228	40-6958	228,279
40-4265	214,277	40-6334	227	40-6716	228	40-6970	228,279
40-4268	215	40-6335	227	40-6717	228	40-6973	228,279
40-4270	215	40-6336	227	40-6723	228	40-6976	228,279
40-4272	214,277	40-6337	227	40-6724	228	40-6979	228,279
40-4360	214	40-6338	227	40-6725	228	40-6984	228,279
40-4365	214	40-6339	227	40-6726	228	40-6986	228,279
40-4372	214,277	40-6340	227	40-6728	228	40-6990	228,279
40-4472	214	40-6341	227	40-6731	228	40-6993	228,279
40-4512	214	40-6532	279	40-6732	228	40-6996	228
40-4560	211,275	40-6534	227,279	40-6733	228	40-6999	228
40-4562	211	40-6535	194	40-6734	228	40-7000	235,281
40-4564	211	40-6536	227,279	40-6735	228	40-7100	235,281
40-4572	211,275	40-6537	194	40-6736	228	40-7110	235,281
40-4575	211	40-6538	227,279	40-6737	228	40-7111	235,281
40-5210	249	40-6540	227,279	40-6738	228	40-7112	235,281
40-5213	250	40-6542	227,279	40-6739	228	40-7113	235,281
40-5311	249	40-6544	279	40-6740	228	40-7114	235,281
40-5312	249	40-6545	227	40-6771	226	40-7115	235,281
40-5395	250,282	40-6548	279	40-6772	226	40-7116	235,281
40-5520	250	40-6549	227	40-6773	226	40-7118	281



40-7120	281	40-8284	241	41-1320	192	42-3418	219
40-7250	236,280	40-8360	243	41-1330	193,195	42-3425	219
40-7265	236,280	40-8375	246,270	41-1332	193,195	42-3427	219
40-7280	236,280	40-8675	245	41-1335	195	42-3429	219
40-7284	236	40-8775	245	41-1338	195	42-3430	219
40-7286	236	40-8862	244	41-1340	194,195	42-3431	219
40-7330	235	40-8962	244	41-1342	194	42-3432	219
40-7331	235	40-8964	244	41-1344	194	42-3435	220
40-7332	235	40-8966	244	41-1346	194	42-3436	220
40-7333	235	40-9070	244	41-1348	194	42-3437	220
40-7334	235	40-9075	244	41-1350	193,229	42-3438	220
40-7335	235	40-9160	244	41-1355	193,229	42-3453	219
40-7336	235	40-9260	244	41-1360	193,229	42-3454	219
40-7337	235	40-9265	246,270	41-1361	195	42-3455	219
40-7338	235	40-9365	246,270	41-1362	195	42-3463	219
40-7346	231	40-9370	246	41-1363	195	42-3464	219
40-7347	231	40-9613	241	41-1365	194	42-3465	219
40-7348	231	40-9685	233,273	41-1366	194	42-3573	219
40-7349	231	40-9688	273	41-1367	194	42-3574	219
40-7360	231	40-9690	233	41-1368	194	42-3575	219
40-7362	231	40-9712	234	41-1370	193	42-3920	221
40-7364	231	40-9812	234	41-1372	193	42-3921	221
40-7366	231	40-9815	233,273	41-1374	193	42-3922	221
40-7368	231	40-9820	233,273	41-1376	193	42-3925	221
40-7370	231	40-9825	233,273	41-1395	112,196	42-3926	221
40-7372	231	40-9840	195	41-1396	112,196	42-3927	221
40-7376	231	40-9841	195	41-1402	110,196	42-4000	222
40-7400	245	40-9990	255	41-1403	110,196	42-4001	222
40-7402	245	41-1045	190	41-1410	109,186	42-4002	222
40-7404	245	41-1047	190	41-1500	496	42-4005	222
40-7406	245	41-1050	20,190	42-1247	103	42-4006	222
40-7410	245,280	41-1058	20,190	42-1365	225	42-4007	222
40-7415	245,280	41-1076	20,191	42-1420	116,240,288	42-4010	222
40-7420	245,280	41-1078	21,191	42-1422	240,288	42-4011	222
40-7430	245	41-1079	21,191	42-1425	116,240,288	42-4012	222
40-7435	245	41-1080	19	42-1511	100	42-4015	222
40-7440	245	41-1100	20	42-1611	100	42-4016	222
40-7445	245	41-1105	20	42-1655	100,224	42-4017	222
40-7450	242,280	41-1120	19	42-1755	224	42-4020	223
40-7451	242,280	41-1125	19	42-1765	100	42-4022	223
40-7452	242,280	41-1140	247	42-1865	100	42-4024	223
40-7453	242,280	41-1145	191	42-1875	100	45-6050	457
40-7454	242,280	41-1167	20	42-1895	100	45-6052	457
40-7455	242	41-1168	21,191	42-1965	100	45-6054	457
40-7456	244	41-1169	21,191	42-1975	100	45-6056	457
40-8100	235	41-1170	191,276	42-1995	100	45-6058	457
40-8101	235	41-1175	211,276	42-2085	389	45-6060	457
40-8102	235	41-1190	185	42-2092	108,389	45-6062	457
40-8103	235	41-1192	185	42-2095	225,389	45-6064	457
40-8104	235	41-1194	185	42-2130	243	45-6066	457
40-8130	235	41-1196	185	42-2140	243	45-6068	457
40-8131	235	41-1198	185	42-2150	220	45-6070	457
40-8132	235	41-1200	185	42-2701	243,288	45-6080	459
40-8136	235	41-1235	189	42-2850	221	45-6082	459
40-8137	235	41-1240	189	42-2851	221	45-6084	459
40-8138	235	41-1250	189	42-2852	221	45-6086	459
40-8175	242	41-1260	193	42-2855	221	45-6088	459
40-8238	242	41-1262	193	42-2856	221	45-6089	459
40-8250	242	41-1264	193	42-2857	221	45-6090	459
40-8252	242	41-1266	193	42-3150	221	45-6092	459
40-8255	242	41-1270	193	42-3152	221	45-6094	459
40-8265	241	41-1272	193	42-3154	221	45-6096	459
40-8270	245	41-1274	193	42-3156	221	45-6098	459
40-8272	245	41-1276	193	42-3158	221	45-6100	459
40-8275	246	41-1300	193	42-3160	221	45-6102	459
40-8280	241	41-1305	193	42-3416	219	45-6104	459
40-8282	241	41-1310	193	42-3417	219	45-6112	459

45-6114.....	459	47-1255.....	18,152	50-1290.....	106	52-1543.....	75,415
45-6116.....	459	47-1345.....	13	50-1355.....	47	52-1545.....	416
45-6118.....	459	47-1360.....	10	50-1357.....	47	52-1546.....	416
45-6120.....	459	47-1447.....	66,69	50-1372.....	45,376	52-1548.....	417
45-6122.....	459	47-1448.....	68	50-1472.....	45,376	52-1550.....	416
45-6124.....	459	47-1470.....	72,334	50-1585.....	113	52-1551.....	416
45-6126.....	459	47-2047.....	67	50-1685.....	113	52-1595.....	405
45-6128.....	459	47-2049.....	67	50-1953.....	117	52-1695.....	405
45-6140.....	459	47-2147.....	67	50-1955.....	117	52-1900.....	418
45-6142.....	459	47-2150.....	169	50-1957.....	117	52-1902.....	418
45-6144.....	459	47-2262.....	246	50-1959.....	492	52-1904.....	418
45-6146.....	459	47-2360.....	246	50-1961.....	492	52-1906.....	418
45-6148.....	459	47-2380.....	188,200,246,270	50-1963.....	492	52-1910.....	418
45-6150.....	459	47-2382.....	200	50-1982.....	117	52-1912.....	418
45-6152.....	459	47-2384.....	200	50-2006.....	117	52-1920.....	419
45-6154.....	459	47-2447.....	67	50-2007.....	117	52-1975.....	401
45-6156.....	459	47-2455.....	216	50-2008.....	117	52-1980.....	401
45-6210.....	459	47-2462.....	106	50-2010.....	117	52-2080.....	401
45-6212.....	459	47-2465.....	215	50-2012.....	117	52-2082.....	401
45-6214.....	459	47-2466.....	215	50-2412.....	250	52-2178.....	402
45-6216.....	459	47-2467.....	215,276	50-2585.....	250	52-2180.....	402
45-6218.....	459	47-2468.....	215,276	50-2586.....	250	52-2380.....	420
45-6220.....	459	47-2470.....	216	50-2670.....	69	52-2382.....	420
45-6222.....	459	47-2480.....	216	50-2770.....	69	52-2385.....	419
45-6224.....	459	47-2500.....	112,196	50-2870.....	69	52-2800.....	430
45-6226.....	459	47-2502.....	112,196	50-2970.....	69	52-2802.....	430
45-6240.....	459	47-2505.....	112,196	50-3047.....	66	52-2804.....	430
45-6242.....	459	47-2507.....	112,196	50-3048.....	69	52-2825.....	30,429
45-6244.....	459	47-2510.....	112,196	50-3049.....	69	52-2845.....	30,429
45-6246.....	459	47-2555.....	112	50-3050.....	68	52-2860.....	30,429
45-6248.....	459	47-2556.....	112	50-3147.....	66	52-2880.....	431
45-6250.....	459	47-2570.....	112	50-3148.....	68	52-2885.....	431
45-6252.....	459	47-2572.....	112	50-3371.....	76	52-2888.....	431
45-6254.....	459	47-2647.....	107	50-3970.....	287	52-2985.....	30
45-6256.....	459	47-2650.....	112,140	50-4462.....	13	52-3160.....	12
45-6260.....	460	47-2651.....	140	50-4562.....	13,306,323	52-3170.....	12
45-6266.....	460	47-2655.....	112	50-4563.....	13,306,323	52-3225.....	430
45-6268.....	460	47-2752.....	112	50-4662.....	13,306,323	52-3240.....	74,391
45-6272.....	460	47-2832.....	101	51-1447.....	85	52-3245.....	430
45-6274.....	460	47-2837.....	87,207	51-1448.....	68,85	52-3260.....	430
45-6276.....	460	47-2852.....	87,207	51-3049.....	85	52-3270.....	74,391,394
47-1047.....	8	47-2913.....	101,133,491	51-3447.....	85	52-3282.....	74,391,394
47-1048.....	8	47-2925.....	87,207	51-3460.....	85	52-3290.....	430
47-1049.....	8	47-2930.....	87,207	51-3480.....	85	52-3295.....	430
47-1058.....	8	47-2935.....	87,207	51-4360.....	85	52-3310.....	74,391,394
47-1059.....	8	47-2955.....	87,207	51-4370.....	85	52-3370.....	74,391,394
47-1068.....	8	47-3040.....	87,207	51-4382.....	85	52-3382.....	74,391,394
47-1069.....	8	47-3057.....	87,207	51-4395.....	85	52-3410.....	74,391,394
47-1080.....	8,19	47-3285.....	249	52-1277.....	107,390	52-3597.....	72,391
47-1081.....	8,19	47-3290.....	249	52-1390.....	417	52-4070.....	334
47-1135.....	14,150	47-3292.....	249	52-1415.....	75,416	52-4113.....	392
47-1140.....	150	47-3294.....	249	52-1417.....	75,416	52-4260.....	74,391
47-1144.....	150	47-3298.....	249	52-1420.....	75,416	52-4280.....	391
47-1145.....	14,150	47-3401.....	247	52-1422.....	75,416	52-4310.....	74,391
47-1146.....	18	47-3402.....	247	52-1425.....	416	52-5062.....	75,393
47-1173.....	69	47-3415.....	248	52-1427.....	416	52-5077.....	75,393
47-1175.....	69	47-3418.....	248	52-1430.....	75,416	52-5095.....	75,393
47-1180.....	69	47-3420.....	248	52-1435.....	75,416	52-5162.....	75,393
47-1186.....	69	47-3422.....	248	52-1485.....	417	52-5177.....	75,393
47-1235.....	14,150	47-3424.....	248	52-1488.....	417	52-5195.....	75,393
47-1240.....	150	47-3502.....	248	52-1530.....	75,415	52-5262.....	75,393
47-1244.....	150	47-3503.....	248	52-1531.....	75,415	52-5277.....	75,393
47-1245.....	14,150	47-3504.....	248	52-1532.....	75,415	52-5295.....	75,393
47-1246.....	15,150	47-3505.....	248	52-1533.....	75,415	52-5306.....	393
47-1247.....	18	47-3510.....	247	52-1540.....	75,415	52-5307.....	393
47-1248.....	15,150	50-1080.....	217	52-1541.....	75,415	52-5309.....	393
47-1250.....	18,152	50-1280.....	106,390	52-1542.....	75,415	52-5312.....	393



52-6575	395	52-6797	411	55-2024	375	55-7445	104,385
52-6577	395	52-6820	410	55-2025	375	55-7465	104,385
52-6579	396	52-6822	410	55-2026	375	55-7675	104,385
52-6580	396	52-6825	420	55-2027	375	55-7685	104,385
52-6582	396	52-6830	409	55-2035	376	55-7785	103,386
52-6585	394	52-6832	409	55-2038	376	55-7880	103,385
52-6587	394	52-6840	409	55-2040	376	55-7980	104,385
52-6588	394	52-6842	409	55-2045	377	55-8282	433
52-6589	394	52-6850	412	55-2050	377	55-8284	433
52-6590	399	52-6860	420	55-2060	377	55-8286	433
52-6592	399	52-6862	420	55-2062	377	55-8288	433
52-6594	399	52-6900	421	55-2112	53	55-8290	433
52-6596	399	52-6902	421	55-2187	53,381	55-8292	433
52-6600	397	52-6904	421	55-2190	53,381	55-8295	433
52-6601	404	52-6910	421	55-2195	53	55-8300	433
52-6602	398	52-6912	421	55-2311	384	55-8302	433
52-6603	397	52-6920	421	55-2320	377	55-8304	433
52-6604	400	52-6925	422	55-2322	377	55-8306	433
52-6605	400	52-6930	422	55-2324	377	55-8310	30,392
52-6620	404	52-6935	422	55-2330	380	55-8380	29,306,323,392
52-6622	404	52-6945	423	55-2334	380	55-8390	432
52-6624	404	52-6946	423	55-2340	379	55-8391	432
52-6626	404	52-6947	423	55-2342	379	55-8392	432
52-6628	404	52-6948	423	55-2350	381	55-8400	432
52-6630	413	52-6950	423	55-2352	381	55-8402	432
52-6631	413	52-6955	424	55-2360	382	55-8488	432
52-6634	413	52-6956	424	55-2395	53,390	55-8495	30,392
52-6635	413	52-6957	424	55-2397	53	55-8611	9,323,392
52-6640	414	52-6960	424	55-2682	378	55-8711	9,323,392
52-6641	414	52-6962	424	55-2684	378	55-9080	11,322
52-6644	414	52-6965	425	55-2685	379	55-9084	11,322,431
52-6645	414	52-6966	425	55-2688	378	55-9090	11,322
52-6648	412	52-6968	425	55-2775	50	55-9094	11,322,431
52-6650	407	52-6975	426	55-2795	50	55-9180	11,322
52-6652	407	52-6976	426	55-2810	50	55-9184	11,431
52-6654	407	52-6977	426	55-2855	50,375	55-9190	11,322
52-6655	398	52-6980	426	55-2870	50,375	55-9194	11,431
52-6657	398	52-6981	426	55-2880	50,375	55-9210	11,305,322
52-6659	398	52-6982	426	55-2890	50,124,375	55-9310	11,305,322
52-6661	412	52-6985	426	55-2892	46	55-9311	11,305,322
52-6662	412	52-6990	427	55-2894	46	55-9411	11,305,322
52-6663	412	52-6991	427	55-2898	375	55-9612	11,305,322
52-6680	410	52-6992	427	55-2912	124,390	55-9614	11
52-6681	410	52-6993	427	55-3012	46,390	57-1320	224
52-6690	394	52-6994	427	55-3080	53,390	57-1322	224
52-6694	394	52-6995	427	55-3110	53,390	57-1325	224
52-6696	394	52-6996	427	55-3200	432	57-1445	110
52-6700	400	52-7000	428	55-4114	73,391	57-1475	106
52-6702	400	52-7020	428	55-4510	387	57-1485	106
52-6704	400	52-7030	428	55-5980	244,387	60-1075	110
52-6706	400	52-7040	422	55-6492	391	60-1085	109
52-6724	402	52-7042	422	55-6887	387	60-1160	110
52-6730	403	52-7044	422	55-6965	387	60-1170	110
52-6732	403	52-7046	422	55-7065	387	60-1350	110
52-6740	411	52-7048	422	55-7115	116,389	60-1370	110
52-6745	405	52-7050	422	55-7125	116,389	60-1460	110
52-6750	406	55-1414	388	55-7167	116,389	60-1616	109
52-6760	406	55-1514	388	55-7175	116,389	60-1617	109
52-6775	407	55-1530	215	55-7192	116,389	60-1618	109
52-6778	407	55-1614	388	55-7195	116,389	60-1656	109
52-6780	409	55-1685	388	55-7196	116,389	60-1661	109
52-6785	408	55-1687	388	55-7220	108,389	60-1666	109
52-6790	408	55-1692	388	55-7230	108,389	60-1671	109
52-6792	408	55-2010	388	55-7355	102,386	60-1676	109
52-6794	408	55-2021	375	55-7360	387	60-1681	109
52-6795	411	55-2022	375	55-7365	387	60-1686	109
52-6796	411	55-2023	375	55-7366	387	60-1691	109

60-1695.....	109	60-5822.....	105	64-3235.....	149	65-3030.....	134
60-1697.....	109	60-5823.....	105	64-3260.....	151,486	65-3040.....	134
60-1699.....	109	60-5824.....	105	64-3270.....	146	65-3041.....	134
60-1797.....	114	60-5826.....	105	64-3272.....	146	65-3042.....	134
60-1891.....	107,390	60-6062.....	105	64-3274.....	146	65-3043.....	134
60-1892.....	107,390	60-6162.....	105	64-3280.....	152,486	65-3050.....	134
60-1893.....	107,390	60-6164.....	105	64-3285.....	152	65-3051.....	134
60-2010.....	114	60-6240.....	102,386	64-3288.....	152	65-3052.....	134
60-2110.....	114	60-6280.....	113	64-3290.....	146,484	65-3053.....	134
60-2185.....	115,312	60-6340.....	101	64-3292.....	146,484	65-3060.....	134
60-2190.....	115,312	60-6370.....	100	64-3294.....	146,484	65-3062.....	134
60-2195.....	115,312	60-6467.....	101	64-3296.....	146,484	65-3094.....	136
60-2395.....	116	60-6570.....	100	64-3297.....	146	65-3095.....	136
60-2710.....	108	60-6575.....	100	64-3298.....	146	65-3096.....	136
60-2712.....	108	60-6670.....	102	65-1012.....	129	65-3097.....	136
60-2713.....	108	60-6710.....	102	65-1022.....	128	65-3140.....	139
60-2714.....	108	60-6870.....	102	65-1120.....	129	65-3162.....	141
60-2812.....	108	60-7070.....	102	65-1127.....	129	65-3170.....	141
60-2912.....	108	60-7110.....	102	65-1227.....	130	65-3171.....	141
60-3012.....	108	60-7120.....	102	65-1332.....	130	65-3172.....	141
60-3070.....	108	60-7125.....	102	65-1427.....	129	65-3173.....	141
60-3085.....	108	60-7130.....	102	65-1522.....	129	65-3174.....	141
60-3090.....	108	60-7200.....	225	65-1528.....	130	65-3180.....	141
60-3112.....	108	64-1150.....	22	65-1530.....	130	65-3181.....	141
60-3113.....	108	64-1240.....	18	65-1532.....	130	65-3182.....	141
60-3114.....	108	64-1241.....	18,152	65-1534.....	130	65-3183.....	141
60-3212.....	108	64-1242.....	16,148	65-1535.....	130	65-3191.....	140
60-3312.....	108	64-1340.....	18	65-1545.....	129	65-3192.....	140
60-3412.....	108	64-1341.....	18	65-1730.....	130	65-3195.....	140
60-3440.....	108	64-1342.....	16,148	65-1740.....	128	65-3198.....	140
60-3594.....	108	64-1345.....	18,24,152	65-1742.....	128	65-3200.....	140
60-3596.....	108	64-1351.....	152	65-1744.....	128	65-3205.....	112,140
60-3598.....	108	64-1442.....	17,153	65-1746.....	128	65-3206.....	112,140
60-3607.....	108	64-1542.....	17,153	65-1748.....	128	65-3215.....	140
60-3610.....	108	64-1735.....	22,152,485	65-1750.....	128	65-3216.....	140
60-3612.....	108	64-1742.....	31,152,486	65-1752.....	128	65-3217.....	140
60-3615.....	108	64-1842.....	31,152,486	65-1754.....	128	65-3230.....	140
60-3617.....	108	64-1942.....	31,152,486	65-1756.....	128	65-3232.....	140
60-3620.....	108	64-1950.....	31,151,484	65-1758.....	128	65-3250.....	140
60-3625.....	108	64-1951.....	31,151,484	65-1765.....	128	65-3255.....	140
60-4242.....	105	64-1952.....	151,484	65-1766.....	128	65-3258.....	140
60-4243.....	105	64-1955.....	151	65-1790.....	128	65-3265.....	140
60-4244.....	105	64-1958.....	151	65-1795.....	128	65-3270.....	140
60-4246.....	105	64-1960.....	31,151,484	65-1815.....	101,133,196,491	65-3285.....	139
60-4252.....	105	64-1961.....	151,484	65-1825.....	133	65-3290.....	139
60-4253.....	105	64-2042.....	13,149	65-1830.....	133,491	65-3292.....	139
60-4254.....	105	64-2142.....	14,150	65-1831.....	133	65-3295.....	139
60-4256.....	105	64-2242.....	146,484	65-1835.....	132	65-4025.....	135
60-5431.....	108	64-2342.....	146,484	65-1841.....	107,132	65-4026.....	135
60-5432.....	108	64-2442.....	31,146,484	65-1842.....	107,132	65-4030.....	135
60-5433.....	108	64-2535.....	31,146,484	65-1843.....	107,132	65-4031.....	135
60-5434.....	108	64-2555.....	149,485	65-1844.....	107,132	65-4032.....	135
60-5435.....	108	64-2655.....	149,485	65-2950.....	137	65-4050.....	138
60-5472.....	106	64-2942.....	149,485	65-2955.....	137	65-4055.....	138
60-5502.....	105	64-3042.....	149,485	65-2958.....	137	65-4062.....	138
60-5503.....	105	64-3050.....	149,484	65-2960.....	137	65-4064.....	138
60-5504.....	105	64-3052.....	149,484	65-3001.....	134	65-4066.....	138
60-5506.....	105	64-3138.....	147,485	65-3002.....	134	65-4068.....	138
60-5602.....	105	64-3140.....	147,485	65-3003.....	134	65-4070.....	138
60-5603.....	105	64-3142.....	147,485	65-3010.....	134	65-4072.....	138
60-5604.....	105	64-3144.....	147,485	65-3016.....	136	65-4074.....	138
60-5606.....	105	64-3145.....	31,147,485	65-3017.....	136	65-4076.....	138
60-5812.....	105	64-3146.....	147,485	65-3018.....	136	65-4078.....	138
60-5813.....	105	64-3148.....	147,486	65-3020.....	136	65-4080.....	135
60-5814.....	105	64-3225.....	149,485	65-3022.....	136	65-4098.....	144
60-5816.....	105	64-3228.....	149,485	65-3025.....	136	65-4099.....	144
60-5820.....	241	64-3230.....	149	65-3028.....	136	65-4100.....	144



65-4101.....	144	65-8205.....	139	66-3742.....	68,156	66-6200.....	161
65-4103.....	144	65-8206.....	139	66-3927.....	77,155	66-6240.....	161
65-4105.....	144	65-8215.....	139	66-4032.....	78,155	66-6242.....	161
65-4107.....	144	65-8216.....	139	66-4034.....	68	66-6250.....	161
65-4120.....	144	65-8350.....	132	66-4132.....	78,155	66-6268.....	161
65-4121.....	144	65-8352.....	132	66-4133.....	155	66-6338.....	161
65-4123.....	144	65-8354.....	132	66-4134.....	68	66-6339.....	161
65-4125.....	144	65-9085.....	132	66-4232.....	78,155,488	66-6340.....	79,161
65-4127.....	144	66-1030.....	165	66-4235.....	78,157	66-6342.....	165
65-6055.....	168	66-1035.....	166	66-4525.....	77,155,156	66-6810.....	173
65-6255.....	90,168	66-1036.....	166	66-4526.....	155,156	66-6811.....	173
65-6265.....	90,169,492	66-1037.....	165	66-4530.....	155,488	66-6812.....	173
65-6350.....	168,491	66-1038.....	166	66-4625.....	77,155,156	66-6813.....	173
65-6352.....	168,491	66-1137.....	165	66-4626.....	155,156	66-6900.....	173
65-6354.....	168,491	66-1235.....	165	66-4840.....	78	66-6902.....	173
65-6357.....	91,168,491	66-1236.....	165,166	66-4950.....	155	66-6910.....	173
65-6358.....	168,491	66-1240.....	165	66-4951.....	155	66-6912.....	173
65-6446.....	168,492	66-1250.....	165	66-4952.....	155	66-6914.....	173
65-6448.....	168,492	66-1255.....	165	66-4953.....	155	66-6916.....	173
65-6452.....	91,168,492	66-1260.....	165	66-5240.....	162	66-6920.....	173
65-6460.....	168,492	66-1265.....	166	66-5340.....	79,162	66-6922.....	173
65-6462.....	168,492	66-1270.....	166	66-5342.....	162	66-6925.....	173
65-6470.....	169,491	66-1275.....	166	66-5345.....	162	66-6930.....	173
65-6475.....	169,491	66-1280.....	166	66-5348.....	162	66-6932.....	173
65-6480.....	169	66-1282.....	166	66-5350.....	162	66-6955.....	164
65-6550.....	89	66-1435.....	166	66-5351.....	162	66-7130.....	78,154,487
65-6552.....	91	66-1535.....	82,163	66-5352.....	162	66-7230.....	78,154,487
65-6732.....	174	66-1635.....	82,163	66-5353.....	162	66-7238.....	154,487
65-6735.....	174	66-1735.....	82,163	66-5355.....	162	66-7240.....	154,487
65-6930.....	164	66-1742.....	82,163	66-5530.....	162	66-7244.....	154,487
65-6950.....	144	66-1745.....	163	66-5942.....	79,164	66-7248.....	154,487
65-6952.....	144	66-1830.....	82,163	66-5950.....	164	66-7250.....	154,487
65-6960.....	144	66-1930.....	157	66-5960.....	164	66-7254.....	154
65-6965.....	144	66-1940.....	78,157,163	66-5962.....	164	66-7256.....	154
65-7000.....	144	66-2005.....	157	66-5968.....	164	66-7258.....	154,489
65-7001.....	144	66-2009.....	157	66-6037.....	78,161	66-7259.....	487
65-7002.....	144	66-2012.....	157	66-6105.....	77,83,159	66-7260.....	154,489
65-7003.....	144	66-2040.....	79	66-6109.....	77,83,159	66-7261.....	487
65-7254.....	135	66-2140.....	78,157	66-6110.....	79,161	66-7347.....	77,161
65-7255.....	135	66-2145.....	157	66-6112.....	79,161	66-7436.....	80
65-7257.....	135	66-2350.....	157	66-6114.....	161	66-7438.....	80
65-7260.....	135	66-2355.....	157	66-6115.....	159,489	66-7440.....	80
65-7265.....	137	66-2440.....	157,488	66-6118.....	159,489	66-7442.....	80,167,490
65-7270.....	137	66-2540.....	79,157,488	66-6120.....	158	66-7447.....	80,167,490
65-7272.....	137	66-2635.....	158	66-6125.....	159,489	66-7542.....	80,167,490
65-7275.....	137	66-2638.....	158	66-6126.....	159,489	66-7642.....	80,167,490
65-7360.....	129	66-2640.....	158	66-6130.....	158	66-7644.....	80,490
65-7400.....	194	66-2740.....	77,156	66-6131.....	158	66-7645.....	80,490
65-7401.....	194	66-2742.....	68,156	66-6132.....	158	66-7653.....	167
65-7402.....	194	66-2750.....	156	66-6133.....	158	66-7654.....	167
65-7403.....	194	66-2755.....	156	66-6140.....	159	66-7655.....	167
65-7410.....	194	66-2840.....	77,156	66-6142.....	159	66-7656.....	167
65-7411.....	194	66-2940.....	77,156	66-6150.....	159	66-7657.....	167
65-7412.....	194	66-2942.....	68,156	66-6152.....	159	66-7658.....	167
65-7422.....	135	66-3140.....	77,156	66-6160.....	159,489	66-7660.....	167
65-7425.....	135	66-3142.....	68,156	66-6162.....	159,489	66-7662.....	167
65-7523.....	175	66-3240.....	77,156	66-6164.....	159	66-7664.....	167
65-7525.....	175	66-3340.....	77,156	66-6166.....	159	66-7666.....	167
65-7526.....	175	66-3342.....	68,156	66-6168.....	159	66-7700.....	141
65-7528.....	175	66-3350.....	156,488	66-6175.....	160	66-7702.....	141
65-7531.....	175	66-3450.....	158,488	66-6178.....	160,489	66-7704.....	141
65-7634.....	174	66-3455.....	158,488	66-6180.....	160,489	66-7710.....	141
65-7635.....	174	66-3460.....	158,488	66-6182.....	160	66-7712.....	141
65-8151.....	141	66-3462.....	158,488	66-6190.....	160	66-7715.....	142
65-8155.....	141	66-3540.....	77,156	66-6192.....	160	66-7718.....	142
65-8185.....	139	66-3542.....	68,156	66-6194.....	160,489	66-7720.....	142
65-8195.....	139	66-3740.....	77,156	66-6196.....	160,489	66-7721.....	142

66-7722	142	66-7903	145	66-8102	171	67-2512	177
66-7723	142	66-7904	145	66-8104	171	67-2513	177
66-7725	142	66-7905	145	66-8106	171	67-2514	177
66-7726	142	66-7906	145	66-8108	171	67-2515	177
66-7727	142	66-7907	145	66-8110	171	67-2516	177
66-7735	142	66-7908	145	66-8112	171	67-2517	177
66-7740	142	66-7909	145	66-8114	171	67-2518	177
66-7742	142	66-7910	145	66-8116	171	67-2519	177
66-7750	142	66-7911	145	66-8118	171	67-2521	177
66-7752	142	66-7912	145	66-8120	171	67-2522	177
66-7760	142	66-7913	145	66-8122	171	67-2523	177
66-7762	142	66-7914	145	66-8150	172	67-2525	177
66-7770	143	66-7915	145	66-8152	172	67-2526	177
66-7772	143	66-7916	145	66-8154	172	67-2540	181
66-7775	143	66-7917	145	66-8156	172	67-2550	181
66-7780	143	66-7918	145	66-8158	172	67-2552	181
66-7782	143	66-7925	145	66-8160	172	67-3402	182
66-7790	143	66-7926	145	66-8162	172	67-3404	182
66-7791	143	66-7927	145	66-8164	172	67-3410	182
66-7792	143	66-7928	145	67-1020	178	67-3411	182
66-7793	143	66-7929	145	67-1021	178	67-3412	182
66-7795	143	66-7930	145	67-1030	178	67-3415	182
66-7814	131	66-7931	145	67-1035	178	67-4504	229
66-7816	131	66-7932	145	67-1036	178	67-4506	229
66-7818	131	66-7933	145	67-1038	178	67-4508	229
66-7820	131	66-7934	145	67-1039	178	67-4510	229
66-7822	131	66-7935	145	67-1040	178	67-4512	229
66-7824	131	66-7936	145	67-1045	178	67-4514	229
66-7830	131	66-7937	145	67-1050	178	67-4604	229
66-7835	131	66-7938	145	67-1052	178,187	67-4606	229
66-7840	131	66-7939	145	67-1058	180	67-4608	229
66-7842	131	66-7940	145	67-1150	76,180,187	67-4610	229
66-7850	131	66-7941	145	67-1350	76,180	67-4612	229
66-7852	131	66-7942	145	67-1450	76,180	67-4614	229
66-7860	145	66-7943	145	67-1455	76,180	67-4620	229
66-7862	145	66-7950	145	67-1465	76,187	67-4622	229
66-7863	145	66-7951	145	67-1732	181	67-4624	229
66-7864	145	66-7952	145	67-1750	181	67-4626	229
66-7865	145	66-7953	145	67-1751	181	67-4628	229
66-7866	145	66-7954	145	67-1752	181,198	67-4630	229
66-7867	145	66-7955	145	67-1753	181,198	67-4632	229
66-7868	145	66-7956	145	67-2005	181	67-5175	217
66-7869	145	66-7957	145	67-2007	181	67-5458	217
66-7870	145	66-7958	145	67-2015	181	67-5987	276
66-7874	145	66-7959	145	67-2020	183,209,528	67-5990	218,276
66-7875	145	66-7960	145	67-2022	183,209,528	67-5992	218,276
66-7876	145	66-7961	145	67-2024	183,209,528	67-5994	218,276
66-7877	145	66-7962	145	67-2115	181	67-6010	176
66-7878	145	66-7963	145	67-2145	181	67-6015	176
66-7879	145	66-7964	145	67-2480	177	67-6020	176
66-7880	145	66-7965	145	67-2481	177	67-6025	176
66-7881	145	66-7966	145	67-2488	177	67-6030	176
66-7882	145	66-7967	145	67-2489	177	67-6031	176
66-7883	145	66-7968	145	67-2490	177	67-6032	176
66-7884	145	66-8000	171	67-2491	177	67-6033	176
66-7885	145	66-8002	171	67-2492	177	67-6200	176
66-7886	145	66-8004	171	67-2493	177	67-6202	176
66-7887	145	66-8006	171	67-2498	177	67-6204	176
66-7888	145	66-8008	171	67-2499	177	67-6206	176
66-7889	145	66-8010	171	67-2500	177	67-7064	182
66-7890	145	66-8012	171	67-2501	177	67-7128	182
66-7891	145	66-8014	171	67-2502	177	67-7256	182
66-7892	145	66-8016	171	67-2503	177	67-7512	182
66-7893	145	66-8018	171	67-2508	177	67-7524	182
66-7900	145	66-8020	171	67-2509	177	67-7548	182
66-7901	145	66-8022	171	67-2510	177	67-7605	182
66-7902	145	66-8100	171	67-2511	177	67-8000	179



67-8006.....	179	70-7503.....	189	74-2590.....	64,202	78-1002.....	111,205
67-8008.....	179	70-7504.....	189	74-3070.....	47,201	78-1003.....	111,205
67-8010.....	179	70-7801.....	192,249,282	74-3075.....	201,380	78-1101.....	111,205
67-8020.....	179	70-7802.....	192,249	74-3175.....	201,380	78-1102.....	111,205
67-8024.....	179	70-7811.....	192	74-3270.....	41,201,303	78-1103.....	111,205
67-8150.....	180	70-7812.....	192	75-1010.....	197	78-1113.....	111,205
67-8152.....	180	70-7813.....	192	75-1015.....	197	78-1201.....	111,205
67-8155.....	180	70-7821.....	192	75-1016.....	197	78-1202.....	111,205
67-8170.....	180	70-7822.....	192	75-1017.....	197	78-1203.....	111,205
67-8172.....	180	70-9001.....	203	75-1025.....	197	78-2813.....	509
67-8174.....	180	70-9002.....	203	75-1026.....	197	78-2821.....	509
67-8176.....	180	70-9003.....	203	75-1140.....	197	78-2822.....	509
67-8177.....	180	70-9004.....	203	75-1141.....	197	78-2823.....	509
67-8178.....	180	70-9005.....	203	75-1400.....	197	78-3360.....	204
67-8180.....	180	70-9101.....	203	75-2160.....	197	78-3460.....	204
67-8188.....	180	70-9102.....	203	75-2161.....	197	78-3545.....	111,205
68-1050.....	184	70-9103.....	203	75-2175.....	197	78-3550.....	111,205
68-1057.....	184	70-9104.....	203	75-2315.....	204	78-3570.....	111,205
68-1157.....	184	70-9105.....	203	75-2318.....	204	79-3230.....	297
68-1257.....	184	70-9200.....	203	75-2320.....	204	80-1082.....	298
68-1357.....	184	70-9201.....	203	75-2322.....	204	80-1410.....	57,296,326
68-1557.....	184	70-9202.....	203	75-5070.....	201	80-1565.....	30,298
68-1665.....	184	70-9203.....	203	75-5267.....	30,201	80-1695.....	298
68-1765.....	184	70-9204.....	203	75-5460.....	10	80-1735.....	297
68-1865.....	184	70-9210.....	203	75-5570.....	11,190,322	80-1742.....	297
68-1890.....	184	73-1015.....	498	75-5670.....	11,190,322	80-1872.....	293,294
68-2175.....	184	73-1082.....	498	75-6387.....	200	80-1910.....	293
70-1020.....	185	73-1085.....	498	75-7077.....	199	80-1911.....	293
70-1030.....	185	73-1086.....	498	75-7080.....	199	80-1912.....	293
70-1035.....	185	73-1179.....	206	75-7282.....	199	80-1914.....	293
70-1040.....	185	73-1180.....	206	75-7382.....	199	80-1945.....	294
70-1041.....	185	73-1181.....	206	75-7482.....	199	80-1950.....	294
70-1060.....	186	73-1182.....	206	75-7490.....	199	80-1951.....	294
70-1070.....	185	73-1183.....	206	75-7491.....	199	80-1952.....	294
70-1071.....	185	73-1184.....	206	75-7492.....	199	80-2100.....	296
70-1072.....	185	73-1185.....	206	75-7575.....	199	80-2120.....	296
70-1075.....	185	73-1186.....	206	75-7590.....	199	80-2125.....	296
70-2292.....	195,233,273	73-1189.....	206	75-9070.....	198	80-2132.....	296
70-2293.....	195,233,273	73-1190.....	206	75-9075.....	198	80-2142.....	295
70-4075.....	186	73-1191.....	206	75-9155.....	198	80-2143.....	295
70-4160.....	186	73-1192.....	206	75-9160.....	198	80-2144.....	295
70-4170.....	187	73-1193.....	206	75-9226.....	198	80-2244.....	293,294,295
70-4262.....	21,190	73-1194.....	206	75-9227.....	198	80-2245.....	293,294,295
70-4275.....	191	73-1195.....	206	75-9245.....	198	80-2260.....	295
70-4350.....	20,190	73-1196.....	206	75-9250.....	198	80-2261.....	295
70-4352.....	20,190	73-1341.....	206	75-9251.....	198	80-2271.....	295
70-4375.....	76,187	73-1342.....	206	75-9405.....	198	80-2272.....	295
70-4385.....	76,187	73-1343.....	206	75-9406.....	198	80-2595.....	295
70-4470.....	76,180,187	73-1344.....	206	75-9407.....	198	80-2688.....	295
70-5090.....	186	73-1345.....	206	75-9408.....	198	80-2689.....	295
70-5170.....	186	73-1346.....	206	75-9409.....	198	80-2690.....	295
70-5176.....	187	73-1351.....	206	75-9505.....	198	80-2715.....	117,297
70-5190.....	192	73-1352.....	206	75-9506.....	198	80-2815.....	117,297
70-5232.....	187	73-1353.....	206	75-9507.....	198	80-2870.....	121,298
70-5235.....	187	73-1354.....	206	75-9508.....	198	80-2910.....	122,298
70-5332.....	187	73-1355.....	206	75-9509.....	198	80-3185.....	298
70-5335.....	187	73-1356.....	206	75-9550.....	252,287	80-3510.....	298
70-5420.....	223	74-1185.....	202	75-9601.....	200	80-3812.....	297
70-5421.....	223	74-1280.....	64,202,327	75-9602.....	200	80-3813.....	297
70-5422.....	223	74-1370.....	86,504	75-9603.....	200	80-3814.....	297
70-5673.....	192	74-1470.....	86,504	75-9611.....	200	80-3922.....	296
70-6165.....	188	74-1570.....	86	75-9612.....	200	80-3927.....	296
70-6166.....	188	74-1670.....	86,504	75-9613.....	200	80-3935.....	296
70-6168.....	188	74-1975.....	202	75-9614.....	200	80-3990.....	299
70-7062.....	188	74-2175.....	202	76-1390.....	204	85-1008.....	301
70-7170.....	229	74-2475.....	61,202	76-1490.....	204	85-1010.....	301
70-7185.....	188	74-2575.....	64,202	78-1001.....	111,205	85-1012.....	301

85-1014.....	301	85-2018.....	316	90-2202.....	365	90-3025.....	103,311
85-1016.....	301	85-2020.....	316	90-2204.....	365	90-3030.....	115
85-1018.....	301	85-2022.....	316	90-2210.....	365	90-3035.....	115
85-1020.....	301	85-2024.....	316	90-2212.....	365	90-3040.....	115
85-1022.....	301	85-2026.....	316	90-2214.....	365	90-3130.....	311
85-1024.....	301	85-2028.....	316	90-2216.....	365	90-3135.....	311
85-1026.....	301	85-2030.....	316	90-2220.....	365	90-3140.....	311
85-1028.....	301	85-2032.....	316	90-2222.....	365	90-3150.....	115
85-1030.....	301	85-2034.....	316	90-2224.....	365	90-3151.....	115
85-1032.....	301	85-2036.....	316	90-2226.....	365	90-3152.....	115,311
85-1034.....	301	85-2038.....	316	90-2230.....	365	90-3153.....	115,311
85-1036.....	301	85-2210.....	316	90-2232.....	365	90-3154.....	115,311
85-1038.....	301	85-2212.....	316	90-2234.....	365	90-3155.....	115
85-1040.....	301	85-2214.....	316	90-2236.....	365	90-3225.....	115
85-1065.....	301	85-2216.....	316	90-2238.....	365	90-3230.....	115,311
85-1070.....	301	85-2218.....	316	90-2240.....	365	90-3235.....	115
85-1075.....	301	85-2220.....	316	90-2242.....	365	90-3327.....	115,311
85-1076.....	301	85-2355.....	303	90-2244.....	365	90-3330.....	115,311
85-1308.....	302	85-2360.....	303	90-2250.....	364	90-3335.....	115,311
85-1310.....	302	85-2365.....	303	90-2252.....	364	90-3422.....	115,311
85-1312.....	302	85-4697.....	107,304	90-2254.....	364	90-3427.....	115
85-1314.....	302	85-4780.....	107,304	90-2258.....	364	90-3430.....	115,311
85-1316.....	302	85-4970.....	107,304	90-2261.....	367	90-3450.....	114,312
85-1318.....	302	85-5346.....	103,304	90-2270.....	299,367	90-3451.....	114,312
85-1320.....	302	85-5350.....	103,304	90-2272.....	367	90-3452.....	114,312
85-1322.....	302	85-6450.....	303	90-2274.....	367	90-3470.....	114,312
85-1324.....	302	85-6550.....	303	90-2276.....	299,367	90-3510.....	114,312
85-1326.....	302	85-6551.....	303	90-2278.....	299,366	90-3525.....	310
85-1328.....	302	85-6555.....	303	90-2279.....	367	90-3526.....	310
85-1330.....	302	87-1052.....	87,207	90-2280.....	57,331	90-3527.....	310
85-1332.....	302	87-1070.....	87	90-2287.....	368	90-3530.....	310
85-1334.....	302	87-2095.....	86,504	90-2288.....	368	90-3535.....	310
85-1336.....	302	87-2195.....	86,504	90-2290.....	367	90-3536.....	310
85-1338.....	302	87-2295.....	86	90-2292.....	367	90-3537.....	310
85-1340.....	302	87-2395.....	86,504	90-2294.....	367	90-3552.....	310
85-1342.....	302	90-1080.....	13,306	90-2298.....	366	90-3555.....	310
85-1345.....	302	90-1180.....	13,306	90-2300.....	368	90-3558.....	310
85-1408.....	302	90-1280.....	13,306	90-2302.....	368	90-3559.....	310
85-1410.....	302	90-1380.....	13,306	90-2304.....	367	90-3560.....	310,361
85-1412.....	302	90-1480.....	13,306	90-2306.....	299,367	90-3561.....	361
85-1414.....	302	90-1580.....	13,306	90-2310.....	367	90-3610.....	312
85-1416.....	302	90-1590.....	9,305,323	90-2312.....	367	90-3692.....	312
85-1418.....	302	90-1690.....	9,305,323	90-2325.....	366	90-3695.....	309
85-1420.....	302	90-1755.....	29	90-2326.....	366	90-3698.....	309
85-1422.....	302	90-1785.....	29	90-2330.....	368	90-3700.....	307
85-1424.....	302	90-1885.....	56,330	90-2340.....	366	90-3701.....	307
85-1442.....	302	90-1977.....	57,331	90-2342.....	366	90-3702.....	307
85-1446.....	302	90-2114.....	363	90-2345.....	368	90-3705.....	307
85-1608.....	302	90-2116.....	363	90-2348.....	368	90-3710.....	308
85-1610.....	302	90-2118.....	363	90-2350.....	368	90-3711.....	308
85-1612.....	302	90-2120.....	363	90-2352.....	366	90-3712.....	308
85-1614.....	302	90-2122.....	363	90-2354.....	55,334	90-3713.....	308
85-1616.....	302	90-2124.....	363	90-2379.....	329	90-3750.....	307
85-1618.....	302	90-2126.....	363	90-2385.....	284	90-3752.....	307
85-1620.....	302	90-2128.....	363	90-2387.....	57,331	90-3754.....	360
85-1622.....	302	90-2131.....	363	90-2480.....	57,329,331	90-3755.....	360
85-1624.....	302	90-2160.....	363	90-2580.....	57,329,331	90-3800.....	307
85-1626.....	302	90-2170.....	365	90-2582.....	329	90-3802.....	307
85-1628.....	302	90-2171.....	365	90-2680.....	57,330	90-3804.....	360
85-1630.....	302	90-2172.....	365	90-2682.....	57,328,330	90-3806.....	360
85-1632.....	302	90-2173.....	365	90-2690.....	328	90-3808.....	360
85-1635.....	302	90-2174.....	365	90-2780.....	56,330	90-3810.....	360
85-1636.....	302	90-2175.....	365	90-2782.....	56,330	90-3812.....	360
85-2010.....	316	90-2177.....	57,329,331	90-2790.....	55,332	90-3815.....	360
85-2012.....	316	90-2180.....	329	90-2792.....	55,332	90-3833.....	360
85-2014.....	316	90-2200.....	365	90-2793.....	55,332	90-3835.....	360
85-2016.....	316	90-2201.....	365	90-2794.....	55,332	90-3837.....	360



90-3839.....	360	90-5422.....	321	90-8111.....	54,328	90-9040.....	359
90-3841.....	360	90-5423.....	321	90-8210.....	320	90-9042.....	359
90-3849.....	308	90-5424.....	321	90-8301.....	112,316	90-9044.....	359
90-3851.....	308	90-5425.....	321	90-8302.....	112,316	90-9046.....	359
90-3865.....	309	90-5426.....	321	90-8303.....	112,316	90-9048.....	359
90-3945.....	308	90-5428.....	321	90-8304.....	112,316	90-9050.....	359
90-3946.....	361	90-5431.....	321	90-8305.....	112,316	90-9055.....	360
90-3948.....	361	90-5432.....	321	90-8306.....	316	90-9065.....	368
90-3954.....	309	90-5433.....	321	90-8332.....	314	90-9066.....	368
90-3957.....	309	90-5434.....	321	90-8333.....	113,314	90-9100.....	361
90-3959.....	309	90-5435.....	321	90-8334.....	113,314	90-9102.....	361
90-3960.....	309	90-5436.....	321	90-8335.....	113,314	90-9106.....	361
90-3990.....	313	90-5438.....	321	90-8336.....	113,314	90-9108.....	361
90-3994.....	313	90-5542.....	320	90-8341.....	314	90-9555.....	336
90-3995.....	313	90-5566.....	320	90-8342.....	113,314	90-9560.....	337
90-3996.....	313	90-5710.....	319	90-8344.....	113,314	90-9565.....	338
90-3997.....	313	90-5713.....	321	90-8346.....	113,314	91-1070.....	60,64,326
90-3998.....	313	90-6095.....	320	90-8348.....	113,314	91-1111.....	59,326
90-4212.....	319	90-6195.....	320	90-8355.....	113,315	91-1275.....	326
90-4312.....	319	90-6280.....	317	90-8360.....	113,315	91-1290.....	59,64,317,326
90-4713.....	319	90-6285.....	320	90-8361.....	315	91-1298.....	59,317,326
90-4784.....	318	90-6290.....	319	90-8362.....	315	91-1455.....	65,326
90-4785.....	318	90-6292.....	319	90-8715.....	334	91-1465.....	65,326
90-4786.....	318	90-6295.....	319	90-8717.....	334	91-1562.....	61,327
90-4787.....	318	90-6320.....	344	90-8720.....	316	91-1590.....	60,332
90-4788.....	318	90-6322.....	344	90-8845.....	361	91-1690.....	332
90-4789.....	318	90-6324.....	344	90-8850.....	362	91-1890.....	60,333
90-4790.....	318	90-6326.....	344	90-8855.....	362	91-1990.....	60,333
90-4791.....	318	90-6328.....	345	90-8858.....	362	91-2080.....	65,334
90-4792.....	318	90-6330.....	345	90-8860.....	362	91-2282.....	55,333
90-4793.....	318	90-6334.....	345	90-8862.....	362	91-2382.....	55,333
90-4794.....	318	90-6335.....	345	90-8865.....	362	91-2482.....	55,331
90-4795.....	318	90-6582.....	320	90-8885.....	361	91-2585.....	55,331
90-4796.....	318	90-6590.....	320	90-8886.....	361	91-2598.....	59,327
90-4797.....	318	90-6600.....	342	90-8900.....	342	91-2695.....	60,327
90-4798.....	318	90-6602.....	342	90-8902.....	342	91-3095.....	59,333
90-4804.....	318	90-6610.....	340	90-8905.....	340	91-3195.....	59,333
90-4806.....	318	90-6611.....	321	90-8920.....	335	91-3695.....	333
90-4808.....	318	90-6612.....	321	90-8925.....	343	91-3795.....	59,333
90-4810.....	318	90-6820.....	341	90-8930.....	343	91-3810.....	59,333
90-4812.....	318	90-6887.....	335	90-8940.....	337	91-3822.....	58
90-4814.....	318	90-7195.....	320	90-8945.....	336	91-3910.....	333
90-4816.....	318	90-7385.....	343	90-8948.....	338	91-4010.....	65
90-4818.....	318	90-7492.....	343	90-8952.....	339	91-4210.....	373
90-4825.....	318	90-7511.....	343	90-8960.....	343	91-4310.....	59,373
90-4826.....	318	90-7520.....	337	90-8962.....	343	91-5010.....	346
90-4910.....	318	90-7525.....	338	90-8964.....	343	91-5012.....	346
90-4912.....	318	90-7530.....	336	90-8966.....	343	91-5014.....	346
90-4914.....	318	90-7540.....	339	90-8970.....	343	91-5018.....	346
90-4916.....	318	90-7551.....	343	90-8972.....	343	91-5020.....	346
90-4918.....	318	90-7552.....	343	90-8974.....	343	91-5022.....	346
90-4920.....	318	90-7553.....	343	90-8976.....	343	91-5024.....	346
90-4925.....	318	90-7554.....	343	90-8980.....	343	91-5028.....	346
90-4926.....	318	90-7555.....	343	90-9000.....	358	91-5032.....	347
90-5215.....	318	90-7556.....	343	90-9002.....	358	91-5034.....	347
90-5219.....	318	90-7557.....	343	90-9004.....	358	91-5036.....	347
90-5223.....	318	90-7558.....	343	90-9005.....	358	91-5040.....	347
90-5227.....	318	90-7560.....	343	90-9006.....	358	91-5042.....	347
90-5231.....	318	90-7610.....	57,296,326	90-9015.....	358	91-5044.....	347
90-5235.....	318	90-7710.....	57,296,326	90-9016.....	358	91-5046.....	347
90-5239.....	318	90-7895.....	54,328	90-9018.....	358	91-5050.....	347
90-5243.....	318	90-7898.....	54,329	90-9020.....	358	91-5060.....	348
90-5250.....	318	90-7977.....	54,328	90-9030.....	359	91-5062.....	348
90-5312.....	317	90-7995.....	54,328	90-9032.....	359	91-5064.....	348
90-5412.....	317	90-8010.....	341	90-9034.....	359	91-5066.....	348
90-5413.....	317	90-8065.....	56,330	90-9035.....	359	91-5068.....	348
90-5421.....	321	90-8090.....	56,330	90-9038.....	359	91-5080.....	349

91-5082.....	348	91-5308.....	356	96-1071.....	174	97-0524.....	266
91-5084.....	348	91-5310.....	356	96-1400.....	502	97-0527.....	246
91-5086.....	348	91-5400.....	357	96-1402.....	502	97-0528.....	266
91-5088.....	348	91-5404.....	357	96-1404.....	502	97-0532.....	266
91-5092.....	348	91-5408.....	357	96-1406.....	502	97-0536.....	266
91-5110.....	349	91-5410.....	356	96-1408.....	502	97-0539.....	266
91-5112.....	349	91-5411.....	356	96-1410.....	502	97-0540.....	269
91-5120.....	351	91-5428.....	356	96-1412.....	502	97-0542.....	266
91-5122.....	351	91-5440.....	357	96-1414.....	502	97-0545.....	269
91-5130.....	351	91-5450.....	356	96-1416.....	502	97-0546.....	267
91-5132.....	351	91-5452.....	356	96-1500.....	503	97-0548.....	267
91-5140.....	351	91-5455.....	356	96-1502.....	503	97-0552.....	267
91-5142.....	351	92-1012.....	371	96-1504.....	503	97-0554.....	267
91-5150.....	350	92-1014.....	371	96-1506.....	503	97-0555.....	29,265
91-5152.....	350	92-1015.....	371	96-1508.....	503	97-0562.....	267
91-5154.....	350	92-1112.....	371	96-1510.....	503	97-0564.....	266
91-5160.....	349	92-1114.....	371	96-1512.....	503	97-0566.....	268
91-5162.....	349	92-1415.....	371	96-1514.....	503	97-0568.....	268
91-5176.....	350	92-1610.....	371	96-1516.....	503	97-0572.....	268
91-5178.....	350	92-1715.....	369	96-1845.....	501	97-0580.....	266
91-5180.....	350	92-1814.....	369	96-1846.....	501	97-0581.....	266
91-5185.....	350	92-1915.....	370	96-1847.....	501	97-0582.....	267
91-5188.....	350	92-2015.....	370	96-1848.....	501	97-0583.....	267
91-5190.....	350	92-2115.....	370	96-1849.....	501	97-0601.....	268
91-5200.....	353	92-2215.....	370	96-1850.....	501	97-0604.....	268
91-5202.....	353	92-2314.....	370	96-1851.....	501	97-0606.....	268
91-5210.....	353	92-2415.....	371	96-1852.....	501	97-0623.....	268
91-5212.....	353	92-2516.....	369	96-1853.....	501	97-0634.....	268
91-5215.....	353	92-2717.....	369	96-1860.....	501	97-0640.....	270
91-5218.....	353	92-2812.....	369	96-1862.....	501	97-0641.....	270
91-5220.....	353	92-2912.....	372	96-1864.....	501	97-1045.....	263
91-5222.....	353	92-2915.....	372	96-1866.....	501	97-1046.....	263
91-5224.....	353	92-3215.....	372	96-1868.....	501	97-1055.....	262
91-5225.....	353	92-3350.....	372	96-1870.....	501	97-1056.....	263
91-5226.....	352	92-3360.....	372	96-1872.....	501	97-1057.....	263
91-5228.....	352	92-4100.....	374	96-1874.....	501	97-1145.....	262
91-5230.....	352	92-4130.....	374	96-1876.....	501	97-1146.....	262
91-5232.....	352	92-4165.....	374	96-1878.....	501	97-1150.....	265
91-5234.....	352	92-5012.....	58,373	97-0005.....	269	97-1155.....	263
91-5235.....	352	92-5095.....	58,373	97-0006.....	269	97-1156.....	263
91-5236.....	354	92-5195.....	58,373	97-0010.....	269	97-1161.....	263
91-5238.....	354	92-5295.....	58,373	97-0011.....	269	97-1172.....	261
91-5240.....	355	92-5298.....	373	97-0015.....	269	97-1174.....	261
91-5241.....	354	92-5310.....	58,374	97-0017.....	269	97-1176.....	261
91-5242.....	354	92-5412.....	58,374	97-0019.....	269	97-1180.....	261
91-5243.....	354	92-5540.....	29	97-0020.....	269	97-1181.....	261
91-5244.....	354	92-6535.....	374	97-0021.....	269	97-1182.....	261
91-5245.....	354	93-1065.....	22	97-0025.....	270	97-1183.....	261
91-5246.....	354	93-1165.....	22	97-0026.....	270	97-1185.....	261
91-5247.....	354	93-2160.....	349,360	97-0027.....	270	97-1235.....	29,264
91-5248.....	354	93-2165.....	349,360	97-0028.....	270	97-1238.....	264
91-5250.....	353	94-1705.....	506	97-0030.....	270	97-1241.....	264
91-5251.....	353	94-1710.....	506	97-0035.....	268	97-1242.....	264
91-5252.....	353	94-1711.....	506	97-0036.....	268	97-1243.....	264
91-5253.....	353	94-1712.....	506	97-0040.....	269	97-1244.....	264
91-5254.....	353	94-1714.....	506	97-0041.....	269	97-1245.....	29,264
91-5255.....	353	94-1720.....	506	97-0048.....	268	97-1250.....	260
91-5258.....	355	94-1725.....	506	97-0050.....	246,270	97-1251.....	260
91-5260.....	355	96-0862.....	530	97-0302.....	264	97-1255.....	260
91-5264.....	355	96-0910.....	300,530	97-0335.....	264	97-1258.....	260
91-5268.....	357	96-1000.....	183,528	97-0474.....	262	97-1259.....	260
91-5270.....	357	96-1001.....	183,528	97-0503.....	266	97-1261.....	260
91-5274.....	357	96-1005.....	183,528	97-0505.....	266	97-1262.....	260
91-5278.....	357	96-1006.....	183,528	97-0507.....	266	97-1280.....	260
91-5300.....	357	96-1010.....	183,528	97-0509.....	266	97-1285.....	260
91-5302.....	357	96-1011.....	183,528	97-0512.....	266	97-1286.....	260
91-5307.....	356	96-1070.....	174	97-0522.....	266	97-1300.....	264



97-1308.....	262	98-1052.....	31	98-7570.....	476	98-7864.....	480
97-1309.....	262	98-1055.....	31	98-7572.....	476	98-7866.....	480
97-1315.....	265	98-1067.....	31	98-7575.....	477	98-7868.....	480
97-1318.....	265	98-1070.....	31	98-7577.....	477	98-7870.....	480
97-1325.....	248	98-1071.....	31	98-7580.....	477	98-7872.....	480
97-1340.....	274	98-1075.....	429	98-7582.....	477	98-7874.....	480
97-1350.....	28,292	98-1076.....	429	98-7585.....	477	98-7876.....	480
97-1351.....	28,292	98-1077.....	429	98-7587.....	477	98-7890.....	480
97-1355.....	292	98-2047.....	69	98-7590.....	477	98-7892.....	480
97-1400.....	210	98-2048.....	69	98-7592.....	477	98-7894.....	480
97-1405.....	210	98-2050.....	47	98-7595.....	477	98-7896.....	480
97-1410.....	210	98-2051.....	47	98-7597.....	477	98-7898.....	480
97-1415.....	210	98-2070.....	47	98-7650.....	477	98-7900.....	480
97-1420.....	210	98-2071.....	47	98-7652.....	477	98-7902.....	480
97-1425.....	210	98-2072.....	74	98-7654.....	477	98-7904.....	480
97-1430.....	210	98-2075.....	74	98-7656.....	477	98-7906.....	480
97-1435.....	210	98-2076.....	74	98-7700.....	478	98-7920.....	481
97-1445.....	210	98-2077.....	74	98-7702.....	478	98-7922.....	481
97-1450.....	210	98-2080.....	83	98-7704.....	478	98-7924.....	481
97-1505.....	273	98-2081.....	83	98-7706.....	478	98-7926.....	481
97-1506.....	273	98-3055.....	487	98-7708.....	478	98-7928.....	481
97-1530.....	84,334	98-3056.....	487	98-7710.....	478	98-7930.....	481
97-1531.....	84,334	98-3070.....	91	98-7712.....	478	98-7932.....	481
97-1540.....	84,334	98-3085.....	91	98-7714.....	478	98-7934.....	481
97-1541.....	84,334	98-3086.....	91	98-7716.....	478	98-7936.....	481
97-1555.....	84,284	98-3170.....	91	98-7718.....	478	98-7950.....	481
97-1560.....	84	98-3171.....	91	98-7720.....	478	98-7952.....	481
97-1565.....	84,285	98-3180.....	491	98-7740.....	478	98-7954.....	481
97-1570.....	84,285	98-3182.....	491	98-7742.....	478	98-7956.....	481
97-1572.....	271	98-3186.....	492	98-7744.....	478	98-7958.....	481
97-1573.....	271	98-3188.....	492	98-7746.....	478	98-7960.....	481
97-1574.....	271	98-3190.....	492	98-7748.....	478	98-7962.....	481
97-1575.....	271	98-3192.....	492	98-7750.....	478	98-7964.....	481
97-1600.....	271	98-4008.....	75,416	98-7752.....	478	98-7966.....	481
97-1605.....	271	98-4012.....	75,416	98-7754.....	478	98-7968.....	481
97-1610.....	271	98-4020.....	75,416	98-7756.....	478	98-7970.....	481
97-1615.....	234,272	98-4108.....	75,416	98-7758.....	478	98-7974.....	481
97-1620.....	234,272	98-4112.....	75,416	98-7760.....	478	98-7976.....	481
97-1625.....	234,272	98-4120.....	75,416	98-7780.....	479	98-8000.....	482
97-1635.....	234	98-7500.....	475	98-7782.....	479	98-8005.....	482
97-1640.....	272	98-7502.....	475	98-7784.....	479	98-8010.....	482
97-1641.....	272	98-7505.....	475	98-7786.....	479	98-8015.....	482
97-1642.....	272	98-7507.....	475	98-7788.....	479	98-8020.....	482
97-1643.....	272	98-7510.....	475	98-7790.....	479	98-8025.....	482
97-1645.....	272	98-7512.....	475	98-7792.....	479	98-8030.....	483
97-1649.....	271	98-7515.....	475	98-7794.....	479	98-8035.....	483
97-1650.....	234	98-7517.....	475	98-7796.....	479	98-8040.....	483
97-1652.....	234	98-7520.....	475	98-7810.....	486	98-8045.....	483
97-1654.....	234	98-7522.....	475	98-7812.....	486	98-8050.....	483
97-1660.....	262	98-7525.....	476	98-7814.....	486	98-8055.....	483
97-1661.....	262	98-7527.....	476	98-7815.....	486		
97-1662.....	262	98-7530.....	476	98-7816.....	486		
97-1663.....	262	98-7532.....	476	98-7817.....	486		
97-1700.....	210	98-7535.....	476	98-7820.....	479		
97-1701.....	210	98-7537.....	476	98-7822.....	479		
97-1702.....	210	98-7540.....	476	98-7824.....	479		
97-1703.....	210	98-7542.....	476	98-7826.....	479		
97-1704.....	210	98-7545.....	476	98-7828.....	479		
97-1705.....	210	98-7547.....	476	98-7830.....	479		
97-1706.....	210	98-7550.....	476	98-7832.....	479		
97-1720.....	210	98-7552.....	476	98-7834.....	479		
97-1721.....	210	98-7555.....	476	98-7836.....	479		
97-1722.....	210	98-7557.....	476	98-7838.....	479		
97-1723.....	210	98-7560.....	476	98-7840.....	479		
97-1724.....	210	98-7562.....	476	98-7842.....	479		
97-1725.....	210	98-7565.....	476	98-7860.....	480		
97-1726.....	210	98-7567.....	476	98-7862.....	480		

A

Abdominal Retractor Doyen.....	114
Abdominal Retractor Mayo.....	114
Abdominal Retractor O'Sullivan-O'Connor ..	103
Abraham Tonsil Knife.....	199
Abramson-Allis Forceps.....	61,327
Ada Dissecting Scissors.....	12
Adair Breast Tenaculum Forceps.....	64
Adenoid Curette Barnhill.....	203
Adenoid Curette Vogel.....	203
Adenotome La Force.....	203
Adson Bayonet Forceps.....	76
Adson Brown Forceps T-C.....	85
Adson Brown Tissue/Suture Forcep Litegrip™ T-C.....	85
Adson Dressing Forceps.....	66,85
Adson Elevator.....	67,68,245
Adson Forceps.....	45,66,67,68,85,376
Adson Forceps Sklarlite™.....	66,67,473
Adson Hook.....	113
Adson Laser Tissue Forceps.....	367
Adson Retractor.....	100
Adson Rongeur.....	216
Adson Sklar Blue™ Forceps.....	356
Adson Suction Tube.....	117
Adson Tissue Forceps.....	66
Adult Sonoscope.....	500
Advancement Forceps Prince.....	79,164
Aebli Corneal Scissors.....	146
Agrikola Sac Retractor.....	133
Air Cystotome Kelman.....	173
Air Injection Cannula.....	173
Aker Kebs Pusher.....	142
Alexander Costal Periosteotome.....	244
Alexander Mastoid Chisel.....	229
Alexander Mastoid Gouge.....	229
Alexander Raspatory.....	387
Allen Intestinal Clamp.....	48
Allen Modification Sklar Original Tonom.....	175
Alligator Action Hartmann Forceps.....	178
Alligator Action Needle Holder T-C.....	98
Alligator Ear Forceps Micro.....	178,180
Alligator Forceps Noyes.....	187
Alligator Grasping Forceps.....	439
Alligator Grasping Forceps Jackson.....	297
Alligator Hartmann Grasping Forceps.....	178
Alligator Napkin Clips.....	505
Allis Forceps.....	56,84,284,327
Allis Forceps T-C.....	84
Allis Forceps Laser Black.....	299,367
Allis Grasping Forceps.....	436,440,444
Allis Tissue Forceps.....	62,63,284,327,357

Allis Tissue Forceps Sklarlite™.....	62,284,474
Allis-Adair Forceps.....	61
Allis-Thoms Forceps.....	61
Alm Self-Retaining Retractor.....	101
Aluminum Fox Eye Shield.....	174
Alvis Foreign Body Spud.....	137
Amniotome Beacham.....	373
Amputating Knife Liston.....	250
Anal Speculum Chelsea Eaton.....	295
Anal Speculum Marlow Laser Black.....	299
Anastomosis Clamp Cooley-Derra.....	424
Anastomosis Clamp Pemberton.....	50
Anastomosis Clamp Rankin.....	52
Anastomosis Forceps Cooley.....	423,424
Anastomosis Forceps Cooley Satinsky.....	423
Anastomosis Clamp, Glover.....	406
Anastomosis Needle Holder T-C.....	325
Anchor Lens Tennant Lens Insertion Hook.....	142
Aneurism And Director Needle Cooper.....	122
Aneurysm Clamp DeBakey Aortic.....	412
Angle Guide Adjustable.....	255
Angular DeBakey Clamp.....	411
Angular Iris Scissors.....	13,149
Angular Scissors Sklar.....	19
Anoscope Hirschman.....	295
Anterior Chamber Cannula Bishop-Harmon.....	173
Anterior Retractor Young.....	107
Antimicrobial Soap Sklar.....	521,525
Aorta Clamp, Diethrich.....	409
Aorta Clamp, Kay.....	407
Aorta Clamp, Subramanian Miniature.....	419
Aortic Aneurysm DeBakey Clamp.....	412
Aortic Clamp, DeBakey-Beck.....	405
Aortic Clamp, Weber.....	410
Aortic Exclusion Clamp, DeBakey.....	404
Aortic Retractors Crawford.....	433
Applicator Brown.....	184
Applicator Buck.....	184
Applicator Endoscopy.....	445
Applicator Farrell.....	184
Applicator Kyle.....	184
Applicator Sawtell.....	184
Applying And Removing Forceps Michel.....	119
Applying Clip Forceps.....	452
Applying Forceps Bulldog Clamp.....	417
Approximator Double Clamp With Frame.....	476
Approximator Lemmon Sternal.....	387
Aproximator With/Without Frame.....	476
Army Pattern Chisel.....	226
Army Pattern Gouge.....	226
Army Pattern Osteotome.....	226
Army Pattern Retractor.....	109
Arruga Capsule Forceps.....	79,162

Arruga Lens Expressor.....	132
Artery Clamp Renal.....	425
Artery Forceps Clark.....	334
Artery Scissors Dietrich Coronary.....	430
Arthroscopic Instruments.....	457-460
Arthroscopic Hook Knife.....	457
Arthro. Maxi Grasper W/ Locking Screw.....	460
Arthroscopic Scissors.....	459
Arthroscopic Spoon Curved.....	457
Aseptic Saw.....	250
Ash Septum Straightening Forceps.....	192
Aspirating Cannula /Simcoe Irrigating.....	173
Atkins Tonsil Knife.....	199
Atlantic Grasper With Ratchet.....	460
Atraumatic Dale Cardiovascular Forceps.....	408
Atraum. DeBak. Periph. Vessel Fcps.....	397,400
Atraumatic Fcps DeBakey.....	398,399,413,414
Atraumatic Forceps DeBakey-Bahnsen.....	411
Atraumatic Forceps DeBakey-Derra.....	407
Atraumatic Intestinal Forceps DeBakey.....	438
Atraum. Tissue Fcps DeBak.....	75,367,393,394
Atraum. Vasc. DeBak. Tissue Fcps.....	395,396
Atrial Cooley Valve Retractors.....	433
Aufranc Cobra Retractor.....	241
Aufricht Face Lift Scissors.....	20
Aufricht Glabellar Rasp.....	195
Aufricht Retractor.....	109,186
Automatic N-I Tourniquet.....	255,287
Auvard Vaginal Speculum Sklar Blue™.....	351
Auvard Vaginal Speculum Laser.....	361
Auvard Weighted Vaginal Speculum.....	310
Awl For Bones.....	254
Awl Bone Perthes.....	254
Axial Handle.....	446
Ayer Chalazion Forceps.....	166
Azar Lens Manipulating Hook.....	141

B

B-Clip Remover Stabler.....	452
Babcock Forceps.....	65,329
Babcock Forceps T-C.....	84,285
Babcock Grasping Forceps.....	440,444
Babcock Sklar Laser Forceps Black.....	299,366
Backhaus Towel Clamp.....	87,207
Backhaus Towel Clamp Laser.....	368
Backstops Laser.....	365
Bacon Rongeur.....	216
Bailey Foreign Body Remover.....	135
Bailey Gigli Saw Guide.....	250
Bailey Rib Contractor.....	387
Bailey-Gibbon Rib Contractor.....	387



Bainbridge Forceps.....	382	Bellucci Micro Ear Scissors	180	Biopsy Set Endometrial Mi-Mark™	344
Bainbridge Vascular Forceps DeBakey	400	Bengolea Forceps.....	377	Bipolar Coagulation Forceps	448
Baird Chalazion Forceps	165	Bennett Tibia Retractor.....	242	Bipolar Grasping Tip.....	448
Baker Ingrown Nail Cutter.....	267	Benson Pylorus Separator.....	52	Bishop-Harmon Anter. Chamber Cannula	173
Bakes Dilator	123	Berens Keratome.....	134	Bishop-Harmon Eye Dressing Forceps	155
Balfour Retractor.....	102	Berens Muscle Clamp.....	164	Bishop-Harmon Forceps.....	68,78
Ball Electrode With Open End	447	Berens Scleral Hook.....	140	Bishop-Harmon Iris Forceps	155
Ballenger Septum Elevator	188	Bergh Cilia Forceps	82,163	Bladder & Suprapubic Retr. Judd-Masson	304
Ballenger Sponge Forceps	86,504	Berke Ptosis Forceps.....	165	Blade Breaker Barraquer	137
Ballenger Swivel Knife	189	Berling-Auvarad Weighted Vag. Speculum	310	Blade Breaker Castroviejo	137
Ballenger Tonsil Seizing Forceps	202	Bessieres Fixation Rings	131	Blade Breaker Swiss Model.....	137
Banana Knife	457	Bethea Sheet Holder	374	Blade Breaker Troutman.....	137
Bandage Scissors, Bantam	27	Bethune Rib Shears.....	388	Blade Scalpel Specialty	210
Bandage Scissors, Burnham Finger	27	Beyer Bone Rongeur	215,218	Blades Diamond	170,172
Bandage Scissors, Knowles	27	Bierer Ovum Forceps.....	58,373	Blades Edge Miniature.....	210
Bandage Scissors, Lister	26	Bifurcated Retractor Young	107	Blades Mini. Edged With Scalpel Handle	209
Bandage Scissors, Lister Sklarlite™	26,467	Biliary Duct Retractor Foss	116	Blades Specialty	210
Bandage Scissors, Sklar Hi Level.....	27	Bill Duck Diss. and Grasping Fcps	437,443	Blades Surgical.....	208
Bane Rongeur.....	216,218	Bill Traction Handle.....	372	Blair (Rollet) Retractor	112
Bantam Bandage Scissors	27	Billeau Ear Curette.....	177	Blake Ear Forceps	180
Barkan Goniotomy Knife.....	136	Billroth Forceps.....	59,333	Blake Gallstone Forceps.....	49
Barnhill Adenoid Curette.....	203	Biopsy Instruments	335-343	Blakesley Biopsy Forceps.....	438
Baron Suction Tube	117,492	Biopsy Blakesley Forceps.....	438	Block, Corneal Cutting	145
Barr Crypt Hook.....	298	Biopsy Fcps, Endoscopy Hysteroscopy.....	453	Blount Knee Retractor	242
Barr Fistula Probe.....	122,298	Biopsy Forceps, Grasping	438	Blower Chip	234
Barr Rectal Retractor	296	Biopsy Forceps, Spoon Jaws	438	Blumenthal Forceps.....	276
Barraquer Blade Breaker	137	Biopsy Forceps, Thoms-Gaylor	298	Bodenham Potter Humby Skin Graft. Knife	496
Barraquer Cilia Forceps.....	82,163	Biopsy Fcps, W/Pin and Retain. Spring.....	439	Bodenhammer Rectal Speculum	296
Barraquer Cyclodialysis Spatula.....	138	Biopsy Micro-Cut Sklar Tisch Oval Punch	337	Boettcher Tonsil Scissors	201
Barraquer Needle Holder.....	91,168,492	Biopsy Oval Punch Wide Bite Sklar.....	337	Bohler Traction Bow	254
Barraquer-Wewecker Iris Scissors	149,485			Boilable Laryngeal Mirror.....	206
Barrett Placenta Forceps	58,374	BIOPSY PUNCHES		Bonaccolto Forceps	79,161
Barrett Tenaculum Forceps	326	Biopsy Punch, Eppendorfer	341	Bond Placenta Forceps	58,374
Barton Obstetrical Forceps	369	Biopsy Punch, Forceps Cut-Thru Type.....	438		
Basin Kidney.....	508	Biopsy Punch, Gaylor	343	BONE INSTRUMENTS	
Basket Cleaning.....	507	Biopsy Punch, Gelhorn	343	Bone And Cartilage Clamp	239,247,285
Basket Forceps.....	459	Biopsy Punch, Kevorkian-Young	340	Bone And Cart. Clamp Dingman Small	240
Baumgartner Needle Holder	88,93,95	Biopsy Punch, Keys.....	317	Bone And Nail Rasp	234,271,272
Bayonet Forceps Adson	76	Biopsy Punch, Micro-Cut Cervical Tischler.....	335	Bone And Plate Holding Forceps.....	239
Bayonet Forceps Gavin Miller.....	51	Biopsy Punch, Micro-Cut Eppendorfer	341	Bone Awl.....	254
Bayonet Forceps Harrington-Mayo.....	73	Biopsy Punch, Micro-Cut Kevork-Young	340	Bone Beyer Rongeur	215
Bayonet Forceps Lucae.....	76,180	Biopsy Punch, Micro-Cut Sklar Kevorkian	339	Bone Clamp Parham-Martin	240
Bayonet Perforator Williams	181	Biopsy Punch, Micro-Cut Uterine Wittner	342	Bone Compression Forceps	239,285
Bayonet Tissue Forceps Harrington-Mayo	391	Biopsy Punch, Oval Micro-Cut Sklar.....	338	Bone Curette Cobb Style	235
Beacham Amniotome	373	Biopsy Punch, Oval Sklar	338	Bone Curette Martini.....	236
Bechert Nucleus Rotator.....	143	Biopsy Punch, Schubert-Van Doren	343	Bone Curette Williger	236
Bechert-McPherson Tying Forceps	160,489	Biopsy Punch, Sklar Kevorkian.....	339	Bone Cutting Forceps Mcindoe	191,276
Beckman-Adson Retractor.....	224	Biopsy Punch, Sklar Tischler Oval.....	337	Bone Cutting Forceps Ruskin-Liston	211
Beckman-Eaton Retractor	224	Biopsy Punch, Tischler Cervical	335	Bone Cutting Forceps Stille-Horsley.....	211
Beckman-Weitlaner Retractor.....	224	Biopsy Punch, Universal Instruments	343	Bone Drill Kirschner	253
Beeson Plaster Spreader.....	259	Biopsy Punch, Wittner Uterine.....	342	Bone Drill-Offset Handle	253,286
		Biopsy Punch, Yeoman Sklar	297	Bone Elevator Hohmann.....	242,280

Bone File.....	233,234,272,273
Bone Forceps Farabeuf.....	237
Bone Forceps Lewin.....	239,285
Bone Forceps Liston.....	211,212,274,275
Bone Forceps Rowland.....	211,276
Bone Gouge West.....	195
Bone Holding Forceps Farabeuf-Lambotte.....	237
Bone Holding Forceps Ferguson.....	238
Bone Holding Forceps Kern.....	237,238,282
Bone Holding Forceps Lagenbeck.....	239
Bone Holding Forceps Lambotte.....	237
Bone Holding Forceps Lane.....	237
Bone Holding Forceps Semb.....	238
Bone Holding Forceps Verbrugge.....	238
Bone Hooks (Volkman).....	241
Bone Lever Cottle.....	194
Bone Mallet Gerzog.....	232,278
Bone Mallet Kirk.....	232,278
Bone Mallet Steel.....	232
Bone Packer Dissector.....	231
Bone Rasp #10.....	272
Bone Rasp Putti.....	234
Bone Rongeur Dean.....	216
Bone Rongeur Freidman.....	218,277
Bone Rongeur Luer.....	216
Bone Saw.....	282
Bone Saw Charriere Metacarpal.....	249
Bone Saw Joseph.....	192,249,282
Bone Saw Lagenbeck.....	282
Bone Saw Nasal Joseph.....	192
Bone Saw Satterlee.....	249
Bone Skid More.....	243
Bone Tamper.....	231
Bone-Podi Rasp.....	271
Bonn Micro Suturing Forceps.....	159,489
Bonn Tying Forceps.....	159,489
Bonney Tissue Forceps.....	73,334
Borchard Wire Guide.....	253
Bosworth Nasal Saw.....	192
Bosworth Tongue Depressor.....	197
Botvin Iris Forceps.....	154,489
Boucheron Ear Speculum.....	176
Bougie A Boule Otis.....	302
Bow Bohler Traction.....	254
Bow Kirschner.....	254
Bowman Lachrymal Dilators.....	144
Boynton Needle Holder.....	169
Boys-Allis Tissue Forceps.....	61
Bozeman Forceps.....	57,326,356,366
Bozeman Forceps Laser.....	366
Bozeman Forceps Sklar Blue™.....	356
Bozeman-Heaney T-C Needle Holder.....	98,325

Brain Forceps Cushing Delicate.....	69
Brantley-Turner Retractor.....	114
Brantley-Turner Vaginal Retractor.....	312
Braun Episiotomy Scissors.....	29
Breaker Barraquer Blade.....	137
Breaker Castrovejio Blade.....	137
Breaker Pediatric Cast Mason.....	258
Breaker Swiss Model Blade.....	137
Breaker Troutman Blade.....	137
Breaker Wolfe-Biehler For Casts.....	258
Brewster Retractor.....	108
Brinckerhoff Speculum.....	295
Bronchus DeBakey Forceps.....	419
Bronchus Lees Clamp.....	420
Brown Applicator.....	184
Brown Dissecting Scissors.....	21,191
Brown Needle Holder.....	88
Brown Tissue Forceps.....	73
Bruening Magnifier Oscope.....	176
Bruns Curette.....	235,281
Bruns Shears.....	257,292
Brush, Instrument Cleaning.....	509,514
Brush Surgeons.....	509
Buck Applicator.....	184
Buck Ear Curette.....	177
Buck-Gramcko Tendon Retriever.....	248
Buck Myringotome.....	181
Buck Neurological Hammer.....	497
Buie Pile Clamp.....	298
Buie Suction Tube.....	117,297
Bulldog Clamp Applying Forceps.....	417
Bulldog Clamp DeBakey.....	75,417
Bulldog Clamp Diethrich Microcoronary.....	75,416
Bulldog Clamp Edwards.....	417
Bulldog Clamp Glover.....	416
Bulldog Clamp Johns Hopkins.....	75,416
Bulldog Clamp Santulli.....	417
Bulldog Glover Clamp Curved.....	416
Bullet And Rectal Probe.....	122
Bunge Evisceration Spoons.....	141
Bunnell Drill-Cannulated.....	253,286
Bunnell Tendon Stripper.....	247
Burs.....	271
Burch Fixation Pick.....	140
Burford-Finocchio Rib Spreader.....	103,385
Burnham Finger Bandage Scissors.....	27
Button Electrode Coagulation.....	447
Button End Knife Joseph.....	193
Button Graether Collar.....	143
Button Micro-Iris Retr. Graether Collar.....	173
Buxton Uterine Clamp.....	65

C

Caliper Castrovejio.....	174
Caliper EKG.....	498
Caliper Thorpe.....	174
Campion Cervical Hook.....	315
Campion Forceps.....	54
Campion Grasping Forceps Sklar Blue™.....	356
Campion Laser Cervical Hook.....	364
Campion Laser Grasping Forceps.....	366
Canfield Tonsil Knife.....	199
Cannula & Trocar.....	450
Cannula Air Injection.....	173
Cannula Anter. Chamber Bishop-Harmon.....	173
Cannula Aspirating/Simcoe Irrigating.....	173
Cannula Holman-Mathieu.....	320
Cannula Irrigation/Suction.....	449
Cannula Simcoe Nucleus Delivery.....	173
Cannulated Bunnell Drill.....	286
Capener Lamina Gouge.....	230
Capener Osteotome.....	230
Caplan Dorsal Scissors.....	191
Capsular Forceps Fuchs Extra.....	162
Capsular Forceps Schweiger Extra.....	162
Capsule Forceps Arruga.....	79,162
Capsule Forceps Castrovejio.....	162
Capsule Forceps Kalt.....	162
Capsulorhexis Kraff-Utrata Forceps.....	162
Cardiovascular.....	393-433
Cardiovascular Forceps Dale Atraumatic.....	408
Cardiovascular Forceps Pediatric.....	418
Carmalt Splinter Forceps.....	81,493
Carrier DeBakey-Semb Ligature.....	412
Carriers Cooley Ligature.....	426
Carter Sphere Introducer.....	164
Cartilage And Bone Clamp.....	239,247,285
Cartilage And Bone Clamp Dingman.....	240
Cartilage Knife Downing.....	248
Cartilage Knife Lowe-Breck.....	248
Casanova Fixation Rings.....	131
Cast Breaker Mason Pediatric.....	258
Cast Breaker Wolfe-Biehler Plaster.....	258,291
Cast Spreader Heavy Duty.....	258,291
Castaneda Neonatal Clamp.....	427
Castrovejio Caliper.....	174
Castrovejio Lachrymal Dilator.....	144
Castrovejio Blade Breaker.....	137
Castrovejio Capsule Forceps.....	162
Castrovejio Cataract Scissors.....	146,484
Castrovejio Colibri Forceps.....	158,488
Castrovejio Corneal Scissors.....	146,484
Castrovejio Cyclodialysis Spatulas.....	138



Castroviejo Fixation Forceps	158	Clamp, Harrington Forceps.....	384
Castroviejo Forceps.....	77,159	Clamp, Harrington-Mixer.....	390
Castroviejo Needle Holder.....	91,491	Clamp, Herrick Kidney.....	50,127
Castroviejo Needle Holder T-C.....	97	Clamp, Hoff Towel.....	87
Castroviejo Scissors.....	31	Clamp, Hysterectomy.....	55,332
Castroviejo Speculum.....	130	Clamp, Intestinal Pean.....	48
Castroviejo Suture Forceps.....	83,159,489	Clamp, Johns Hopkins Bulldog.....	75
Castroviejo Trepines.....	145	Clamp, Jones Cross Action Towel.....	87
Castroviejo-Kalt Needle Holder.....	90,168	Clamp, Kantrowitz.....	50
Cataract Castroviejo Scissors.....	484	Clamp, Kay Aorta.....	407
Cataract Knives Graefe.....	134	Clamp, Kidney Herrick.....	127
Cataract Scissors Castroviejo.....	146	Clamp, Kidney Stille.....	127
Catheter Forceps Gordon.....	74	Clamp, Laser Wand.....	360
Catheter Forceps Magill.....	65	Clamp, Lees Bronchus.....	420
Catheter Gordon Introducing Forceps.....	391	Clamp, Lorna (Edna) Towel.....	87
Catheter Guides.....	303	Clamp, Lowman.....	236,282
Catheters Female.....	316	Clamp, Mayo-Guyon Kidney.....	51,127
Castroviejo Keratome.....	134	Clamp, Mogen Circumcision.....	303
Cava Cooley Occlusion Clamp.....	422	Clamp, O'Hanlon Intestinal.....	48
Center Blade Balfour Retractor.....	102	Clamp, Payr Pylorus.....	52
Cervical Biopsy Punch Tischler.....	335	Clamp, Pean Intestinal.....	48
Cervical Hook.....	315	Clamp, Pedicle Wertheim-Cullen.....	127
Cervical Hook, Champion.....	315,364	Clamp, Pemberton Anastomosis.....	50
Cervical Hook Sklar.....	113,355	Clamp, Pratt T-Shape.....	124
Cervical Laminectomy Rong, Schlesinger.....	220	Clamp, Rankin Anastomosis.....	52
Cervical Laser Hook.....	364	Clamp, Renal Artery.....	425
Cervical Manipulator Newport.....	315,364	Clamp, Roeder Towel.....	87,207
Cervical Manipulator Sklar.....	113,355	Clamp, Santulli Bulldog.....	417
Cervix Forceps Gutglass.....	55	Clamp, Satinsky Vena Cava.....	405
Chalazion Curette Meyhoefer.....	141	Clamp, Sesamoid.....	240,285
Chalazion Forceps Ayer.....	166	Clamp, Sklar Meniscus.....	247
Chalazion Forceps Baird.....	165	Clamp, Sklar Thoracic.....	53,390
Chalazion Forceps Francis.....	165	Clamp, Sklar Towel Cross Action.....	87
Chalazion Forceps Heath.....	165	Clamp, Stille Kidney.....	51
Chalazion Forceps Hunt.....	165	Clamp, Stockman (Zipser) Penis.....	303
Chalazion Forceps Lambert.....	165,166	Clamp, Subramanian Aorta Miniature.....	419
Chalazion Forceps Lordon.....	166	Clamp, T-Shaped Pratt.....	303
Chalazion Forceps Spencer.....	165	Clamp, Tendon Sklar.....	247
Chalazion Forceps Weis.....	166	Clamp, Textor Vasectomy.....	303
Chandler Elevator.....	245	Clamp, Thoracic DeBak.-McQuigg-Mixer.....	420
Chandler Iris Forceps.....	77,78,155	Clamp, Towel Backhaus.....	207
Charriere Metacarpal Bone Saw.....	249	Clamp, Towel Cross Action Jones.....	207
Cheek Retractor Sklar.....	197	Clamp, Towel Hoff.....	207
Chelsea Eaton Anal Speculum.....	295	Clamp, Towel Laser Backhaus.....	368
Chip Blower.....	234	Clamp, Towel Lorna (Edna).....	207
Chisel Alexander Mastoid.....	229	Clamp, Tube Occluding.....	86
Chisel Army Pattern.....	226	Clamp, Vascular DeBakey.....	403
Chisel Corn.....	269	Clamp, Vascular Single.....	475
Chisel Cottle Nasal.....	194	Clamp, Wand Sklar Blue™.....	349
Chisel Fomon Nasal.....	194	Clamp, Weber Aortic.....	410
Chisel Freer.....	193,195	Clamp, Wertheim-Cullen Pedicle.....	52
Chisel Hajek Septum.....	195	Clamp, Clark Artery Forceps.....	334
Chisel Hoke.....	228,278		
Chisel Knife.....	269		
Chisel Lebsche Sternum.....	388		
Chisel Lexer Mini.....	230		
Chisel Stille Type.....	227		
Chuck Steinmann Pin.....	254		
Cicherelli Rongeur.....	216		
Cilia Forceps Barraquer.....	82,163		
Cilia Forceps Bergh.....	82,163		
Cilia Forceps Douglass.....	82,163		
Cilia Forceps Gradle.....	163		
Cilia Forceps Littauer.....	82,163		
Cilia Forceps Zeigler.....	82,163		
Cinelli Osteotome.....	193		
Circumcision Clamp Mogen.....	303		
Citelli Rongeur.....	194		
CLAMPS			
Clamp, Allen Intestinal.....	48		
Clamp, Anastomosis Cooley.....	424		
Clamp, Aortic Exclusion DeBakey.....	404		
Clamp, Application Forceps Sklar.....	477		
Clamp, Backhaus Towel.....	87		
Clamp, Berens Muscle.....	164		
Clamp, Bone Parham-Martin.....	240		
Clamp, Buie Pile.....	298		
Clamp, Bulldog Applying Forceps.....	417		
Clamp, Bulldog Johns Hopkins.....	416		
Clamp, Buxton Uterine.....	65		
Clamp, Cartilage And Bone.....	239,247,285		
Clamp, Castaneda Neonatal.....	427		
Clamp, Clark.....	55		
Clamp, Cooley Cava Occlusion.....	422		
Clamp, Cooley Multi-Purpose.....	421		
Clamp, Cooley Neonatal Vascular.....	426		
Clamp, Cooley-Derra Anastomosis.....	424		
Clamp, Curved Glover.....	406		
Clamp, De Alvarez.....	330		
Clamp, DeBakey Angular.....	411		
Clamp, DeBakey Aortic Aneurysm.....	412		
Clamp, DeBakey Bulldog.....	75,415		
Clamp, DeBakey Peripheral Vascular.....	397		
Clamp, DeBakey-Beck Aortic.....	405		
Clamp, DeBakey-Coloviras-Rumel.....	420		
Clamp, DeBakey-Rumel.....	402		
Clamp, Diethrich Microcoron. Bulldog.....	75,416		
Clamp, Dietrich Aorta.....	409		
Clamp, Edwards Bulldog.....	417		
Clamp, Fixation.....	438		
Clamp, Glover Anastomosis.....	406		
Clamp, Glover Bulldog.....	416		
Clamp, Gusberg Hysterectomy.....	56,330		

Clark Clamp	55	Comfort Grip™ Flash Steri. Instr Tray	506	Cottle Bone Lever	194
Claw Forceps With Retaining Spring	437,440	Comfort Grip™ Instrument Sterili. Tray	506	Cottle Dorsal Scissors	21
Clayman Guide	141	Commander Utility Shears	27,257,292	Cottle Elevator	189
Clayman Iris Hook	143	Common Duct Probe/Spoon, Mayo	125	Cottle Nasal Chisel	194
Clayman-Iol Inserting Forceps	167	Compression Forceps Bone	239,285	Cottle Nasal Scissors.....	21,191
Cleaner Sklar Instru-Guard One-Step	526	Cone Ring Curette	235	Cottle Rasp	233,273
Cleaning & Sterilizing Products	501-527	Conjunctival Forceps Lester	78	Cottle Septal Speculum	185
Cleaning Basket.....	507	Continuous Ear Syringe Apparatus	182	Cover With Stand for Tonometer	175
Cleaning Brush	509	Contractor Bailey Rib.....	387	Covers & Pans for Sterilizing	507
Cleaning Instrument Brush	509	Contractor Rib Bailey-Gibbon.....	387	Crafoord Forceps.....	380
Cleaning Instrument Brushes-Bristle End.....	509	Converse Retractor.....	110,196	Craig Forceps	64,327
Clemetson Forceps.....	54,328	Cook Eye Speculum	128	Craig Tonsil Seizing Forceps.....	202
Clemetson Forceps Sklar Blue™	357	Cooley Anastomosis Clamp.....	424	Crawford Aortic Retractors	433
Clemetson Laser Forceps.....	368	Cooley Anastomosis Fcps/Clamps.....	423,424	Crawford Suture Ring	433
Clip Applying Forceps.....	452	Cooley Atrial Valve Retractors	433	Cream for Hands	525
Clip Applying Forceps Hegenbarth	120	Cooley Cava Occlusion Clamp	422	Crego Elevator.....	245
Clip Applying Forceps Michel	83	Cooley Coarctation Forceps	422	Crile Duct Forceps	49
Clip Forceps Hegenbarth.....	83	Cooley-Derra Anastomosis Clamp	424	Crile Gall Duct Forceps.....	52
Clip Forceps Wachenfeldt.....	83,120	Cooley Dilators	428	Crile Hemostatic Forceps	40
Clip Removing Forceps Michel	119	Cooley Ligature Carriers.....	426	Crile Hemostatic Forceps Delicate	40
Clips Wachenfeldt Wound	120	Cooley Multi-Purpose Clamps	421	Crile Hemostatic Forceps Sklarlite™	40
Coagulation Bipolar Forceps	448	Cooley Neonatal Vascular Clamp.....	426	Crile Retractor.....	110
Coagulation Button Electrode	447	Cooley Patent Ductus Forceps	422	Crile-Murray Needle Holder	88
Coagulation Electrode	447	Cooley Satinsky Anastomosis Forceps	423	Crile-Murray Needle Holder T-C	94
Coagulation Spatula Electrode	447	Cooley Vascular Forceps.....	422	Crile-Murray NH T-C Sklargrip™	92
Coagul. Suction Tube W/Trumpet Valve	447	Cooley Vascular Tissue Forceps	394,426	Crile-Wood Needle Holder.....	89,324
Coarctation Forceps Cooley	422	Cooper Director And Aneurism Needle	122	Crile-Wood Needle Holder T-C.....	95,99
Cobb Style Bone Curette	235	Corey Ovum Forceps.....	58,373	Crown & Collar Cutting Scissors.....	28,290
Cobb Type Spinal Gouge	228	Corn Chisel.....	269	Crutchfield Tongs.....	250
Cobra Grasping Forceps	436,437,443	Corn Knife Extra Heavy	269	Crypt Hook Barr	298
Cobra Retractor Aufranc.....	241	Corn Knife Soft	268	Crypt Hook Pratt	298
Cohan Needle Holder	169,491	Corneal Aebli Scissors.....	146	Culler Rectus Muscle Hook	140
Colangiogram Guide.....	448	Corneal Castroviejo Scissors.....	146,484	Cup Iodine	508
Colcloigh Disc Rongeur	220	Corneal Colibri Utility Forceps	487	Cup Medicine.....	508
Colibri Castroviejo Forceps.....	488	Corneal Cutting Block	145		
Colibri Corneal Forceps Maumenee	158,488	Corneal Forceps Maumenee Colibri	158	CURETTES	
Colibri Corneal Utility Forceps	154,487	Corneal Gill Knife.....	136	Curette, Barnhill Adenoid.....	203
Colibri Forceps Castroviejo.....	158	Corneal Maumenee Colibri Forceps	488	Curette, Billeau Ear.....	177
Collar & Crown Cutting Scissors.....	290	Corneal Scheie-Westcott Section Scis.	485	Curette, Bone Martini.....	236
Collar Graether Button.....	143	Corneal Scissors Mcguire.....	146	Curette, Bruns.....	235,281
Collar Graether Button Micro-Iris Retr.	173	Corneal Scleral Forceps Girard	158	Curette, Buck Ear	177
Collector Gall Stone.....	451	Corneal Section Scissors Scheie-Westcott ..	147	Curette, Cobb Style Bone	235
Coller Hemostatic Forceps	44	Corneal Tooke Knife	136	Curette, Cone Ring	235
Collier Needle Holder.....	89	Corneal Troutman-Barraquer Utility Fcps ..	154	Curette, Ear Disposable.....	528
Collin Forceps.....	59,64	Corneal Utility Forceps Colibri	154	Curette, Endocervical Helix Mi-Mark™	345
Collin Vaginal Speculum.....	308,350,361	Corneal Utility Forceps Girard	158	Curette, Endocervical Kevorkian-Younger...321	
Collin-Duval Lung Grasping Forceps.....	126	Corneal Utility Fcps Troutman-Barraquer ...	487	Curette, Excavator	266
Collins Rib Shears	388	Corneoscleral Forceps Thorpe	77	Curette, Fox Dermal	281,496
Collins Tongue Seizing Forceps	65,504	Coronary Artery Scissors Dietrich.....	430	Curette, Gusberg Endocervical.....	320
Collyer Pelvimeter.....	374	Coryllos Rib Shears	388	Curette, Heaney Uterine	320
Colver-Coakley Forceps	61,202	Costal Periosteotome Alexander	244	Curette, Heath	141
Comedone Extractor.....	495	Cottle Black Finish Septal Speculum.....	185	Curette, Holden Uterine	319



Curette, Lounsbury Placenta	321
Curette, Meyhoefer Chalazion	141
Curette, Novak Endometrial.....	319
Curette, Piffard.....	281
Curette, Piffard Dermal.....	496
Curette, Randall Endometrial.....	319
Curette, Ring.....	457
Curette, Shapleigh Ear	177
Curette, Sims Uterine	321
Curette, Skeele	141
Curette, Sklar Dermal	281
Curette, Sklar Endocervical Mini.....	320
Curette, Thomas Uterine	321
Curette, Uterine Greene	320
Curette, Uterine Skene	320
Curette, Verucca.....	266
Curette, Vogel Adenoid.....	203
Curette, Volkmann	236,280
Curette, Williger Bone.....	236
Cusco Vaginal Speculum.....	309
Cusco Vaginal Spec. for Electrosurgery	350
Cushing Brain Forceps Delicate	69
Cushing Forceps Delicate.....	69
Cushing Vein Retractor.....	106
Cut-Thru Type Biopsy Punch Forceps.....	438
Cutaneous Keyes Punch.....	495
Cuticle And Nail Nipper.....	264
Cuticle And Nail Scissors.....	29
Cuticle Nipper	264
Cutter, Baker Ingrown Nail.....	267
Cutter, Diamond Pin	251,289
Cutter, Double Action Pin	287
Cutter, Finger Ring Keyes	496
Cutter, P.I. Plug With Obturator.....	243,288
Cutter, Pin And Wire T-C.....	251, 289
Cutter, Sklar Finger Ring	496
Cutting Block Corneal	145
Cutting Forceps Littauer	260
Cutting Forceps Litt. Action-Sklar Double.....	261
Cutting Forceps Littauer Sklar-Angular.....	261
Cutting Forceps McIndoe Bone	276
Cutting Forceps Ruskin-Liston Bone	211
Cutting Forceps Sklar-Taper Littauer.....	261
Cutting Forceps Stille-Horsley	211
Cutting Forceps Sklarlite™ Littauer	260
Cutting Forceps Struycken	187
Cutting Scissors Crown & Collar.....	28,290
Cutting Wire Suture Scissors.....	23,290
Cyclodialysis Barraquer Spatula.....	138
Cyclodialysis Castroviejo Spatulas	138
Cyclodialysis Spatula Elschmig	138
Cystotome Kelman Air.....	173

Cystotome Von Graefe	136
Cystotome Wilder	136

D

Dale Atraumatic Cardiovascular Forceps	408
Dale First Rib Rongeur	215
Dandy Scalp Hemostat	47
Davidson Scapula Retractor	116,389
Daviel Lens Spoon.....	139
Davis Forcep.....	47,201
Davis Foreign Body Spud	135
Day Ear Hooks.....	181
De Alvarez Forceps	56,330
De Lee Obstetrical Forceps	371
Dean Bone Rongeur.....	216
Dean Scissors.....	30,201
Dean Tonsil Knife	199
Deaver Retractor Sklargrip™ Handle	108
Deaver Scissors Delicate.....	8
DeBakey Angular Clamp	411
DeBakey Aortic Aneurysm Clamp.....	412
DeBakey Aortic Exclusion Clamp	404
DeBakey Atraumatic Fcps	398,399,413,414
DeBakey Atraumatic Intestinal Forceps.....	438
DeBak. Atraum. Periph. Vessel Fcps	397,400
DeBak. Atraum. Tissue Fcps.....	75,317,393,394
DeBakey Atraum. Vascular Forceps.....	395,396
DeBakey-Bahnon Atraumatic Forceps.....	411
DeBakey Bainbridge Vascular Forceps	400
DeBakey-Beck Aortic Clamp	405
DeBakey Bronchus Forceps	419
DeBakey Bulldog Clamp.....	75,415
DeBakey-Coloviras-Rumel Clamp	420
DeBakey-Derra Atraumatic Forceps.....	407
DeBakey Diss. and Grasping Forceps.....	436
DeBakey Dissecting And Ligature Fcps	410
DeBakey Endarterectomy Scissors	432
DeBakey Forceps T-C	84,334
DeBakey Halsted Mosquito Forceps	409
DeBakey Intestinal Forceps.....	441,444
DeBakey-McQuigg-Mixter Thorac. Clamp	420
DeBakey Needle Holder Sklargrip™ T-C	93
DeBakey Pean Forceps	409
DeBakey Pediatric Forceps	418
DeBakey-Rumel Clamp	402
DeBakey-Semb Ligature Carrier.....	412
DeBakey Tangential Occlusion.....	404
DeBakey Vascular Clamps	397,403
DeBakey Vascular Scissors.....	430,431
Delaborde Tracheal Dilator.....	204

Delee Internal Pelvimeter	374
Delee Retractor.....	114,312
Delee Uterine Forceps.....	54,328
Delee-Hillis Obstetrical Stethoscope	500
Delivery Cannula Simcoe Nucleus	173
Delivery Syringe Sklar Measured Dose	316
Depressor Tongue Bosworth	197
Depressor Wieder Tongue.....	197
Depth And Width Rulers for Laser	365
Derf Needle Holder	88
Derf Needle Holder T-C	92,94
Dermal Curette Fox	281,496
Dermal Instruments	493-496
Dermal Keyes Punch Set.....	495
Dermal Piffard Curette	496
Dermal Punch/Keyes Vulvar.....	317
Dermal Sklar Curette	281
Deschamp Needle	120,283
Desjardin Gallstone Scoop	125
Desmarres Lid Retractor.....	107,132,166
Deterg. Sklar Instru-Guard Dual Enzym.	527
Deter. Sklar Kleen for Instr.	513,520,521,524
DeVilbiss Vaginal Speculum.....	309
Dewecker Iris Scissors	149,485
Dewey Obstetrical Forceps.....	372
Diagnostic Instruments	497-500
Diamond Blade Micrometer Knife	172
Diamond Blades	170
Diamond Pin Cutter	251,289
Diamond Titanium Phanco Knife Sklar	171
Diamond Titanium Step Knife Sklar.....	171
Diethrich Microcoron. Bulldog Clamp	75,416
Dietrich Aorta Clamp.....	409
Dietrich Coronary Artery Scissors.....	430

DILATORS

Dilation Set	451
Dilator, Bakes	123
Dilator, Bowman Lachrymal.....	144
Dilator, Cooley	428
Dilator, Castroviejo Lachrymal.....	144
Dilator, Catheters Walther	316
Dilator, Delaborde Tracheal.....	204
Dilator, Goodell Uterine	319
Dilator, Hank Uterine	318
Dilator, Hegar Uterine	318
Dilator, Infant Lachrymal.....	144
Dilator, Lachrymal Ziegler.....	144
Dilator, Muldoon Lachrymal.....	144
Dilator, Pratt Uterine	318
Dilator, Ruedemann Lachrymal	144
Dilator, Trousseau Tracheal	204

Dilator, Vessel.....	483
Dilator, Wilder Lachrymal.....	144
Dilator, Wylie Uterine	319
Dilator, Vascular Short/Long.....	428
Dilator, Williams Lachrymal	144
Dingman Small Bone And Cart. Clamp	240
Dingmann Forceps	247
Director And Aneurism Needle Cooper	122
Director And Probes	121-122
Director And Tongue Tie.....	121
Disc Rongeur Colcloigh	220
Disc Rongeur Wilde Intervertebral.....	223
Discission Wheeler Knife	134
Disinfectant Sklar, For Surfaces	516,519,525
Disinfect. for Instruments-Sklar Soak™	510
Disposable Ear Curette.....	183,528
Disposable Eye Shields	174
Disposable Miniature Ear Knife	183,209,528
Disposable Products.....	300,530
Disposable Smoke Evac. Tubing.....	349,360
Dissecting And Grasping Forceps	436,439
Dissecting And Ligature Fcps DeBakey	410
Dissecting DeBakey And Grasping Fcps.....	436
Dissecting Dolphin Forceps	436
Dissecting Dolphin Grasp. Forceps-Spoon.....	437
Diss. Duck Bill And Grasping Fcps	437,443

DISSECTING SCISSORS

Dissecting Forceps Semb	53
Dissecting Mayo Scissors.....	323,392
Dissecting Mayo Scissors Sklarlite™	464
Dissecting Metzenbaum Scissors Delicate.....	431
Dissecting Scissors, Mayo-Stille Sklar Edge™ T-C.....	34
Dissecting Scissors, Ragnell Sklarcut™ Sklarlite™	32
Dissecting Scissors, Ada	12
Dissecting Scissors, Brown	21,191
Dissecting Scissors, Essrig.....	12
Dissecting Scis., Glassman Thin Point.....	190
Dissecting Scissors, Mayo.....	9,305
Dissecting Scis., Mayo Sklar Edge™ T-C	34
Dissecting Scissors, Mayo Sklarcut™	33,468
Dissecting Scis., Mayo Sklarlite™	9,305,464
Dissecting Scissors, Mayo-Noble	12,305
Dissecting Scissors, Mayo-Noble-Stille	12
Dissecting Scissors, Mayo-Stille.....	12,305,323
Dissecting Scissors, Metzenbaum.....	11,190,322
Dissecting Scissors, Metzenbaum Sklar Edge™ T-C.....	35
Dissecting Scissors, Metzenbaum Sklarlite™ XD	11,465
Dissecting Scissors, Miller	19

Dissecting Scissors, Ragnell	21,32
Dissecting Scissors, Sealy.....	152
Dissecting Scissors, Sklar Edge™ T-C	35
Dissecting Scis., Sklarlite™ Metzenbaum	465
Dissecting Semb Forceps.....	390
Dissector And Pillar Retractor Hurd Tonsil	200
Dissector Bone Packer	231
Dissector Frazier Blunt	246
Dissector Freer	246
Dissector Lemmon Intima	432
Dissector Maryland	437,441,443,444
Dissector Mixer	441,444
Dissector West Blunt	246
Dittel Urethral Sound	302
Divergent Laufe Outlet Forceps Ob.....	372
Dix Foreign Body Spud.....	135
Dolphin Dissecting Forceps	436
Dolphin Dissecting Grasp. Fcps -Spoon.....	437
Dorsal Scissors Caplan	191
Dorsal Scissors Cottle	21
Dorsey Intestinal Forceps	438
Double Action Littauer Cutting Fcps Sklar	261
Double Action Pin Cutter	251,287
Double Action Wire Extraction Pliers T-C	288
Double Clamp Approximator	476,477
Double Ended Probe	121
Double Hook Guthrie	112
Douglass Cilia Forceps.....	82,163
Douglass Tonsil Knife	199
Downing Cartilage Knife	248
Doyen Abdominal Retractor.....	114
Doyen Forceps	48
Doyen Retractor.....	115,312
Doyen Rib Raspatory.....	387
Doyen Scissors.....	12,306,323
Doyen Vulsellum Forceps.....	55,331
Doyen-Jansen Mouth Gag.....	197

DRESSING FORCEPS

Dressing Eye Forceps	156
Dressing Forceps and Tissue Forceps.....	68-85
Dressing Forceps Adson	66
Dressing Forceps Adson T-C	85
Dressing Forceps Bishop-Harmon Eye	155
Dressing Forceps Laser	299
Dressing Forceps Bozeman	296
Dressing Forceps Eye	77
Dressing Forceps Knight	186
Dressing Forceps Semkin.....	73
Dressing Forceps Sklarlite™	70,474
Dressing Forceps T-C.....	85
Dressing Forceps T-C Potts-Smith	85
Drill, For Bones - Kirschner.....	253

Drill, For Bones - Sklar Offset Handle.....	253,286
Drill, Bunnell Cannulated	286
Drill, Cannulated Bunnell	253
Drill, Moore	253
Drill, Myoma.....	451
Drill, Sklar Finger Nail.....	496
Driver K Wire	286
Duck Bill Dissecting And Grasp. Fcps	437,443
Duct Forceps Crile	49
Ductus Forceps Cooley Patent	422
Duke Improved Trocar.....	118
Duplay Tenaculum Forceps.....	59,326
Dura Scissors	13
Duty Cast Spreader Heavy	258
Duval Grasping Forceps.....	440,444
Duval Lung Grasping Forceps.....	126

E

Ear Instruments	176-184
Ear Curette, Billeau.....	177
Ear Curette, Buck	177
Ear Curette, Disposable.....	183,528
Ear Disposable Miniature Knife	528
Ear Forceps, Blake	180
Ear Forceps, Littauer	178
Ear Forceps, Micro Alligator	178,180
Ear Forceps, Weingartner.....	180
Ear Forceps, Wilde	76,180
Ear Hook, Day	181
Ear Knife, Disposable Miniature	209
Ear Knife, Gerzog (Sexton).....	181
Ear Knife, Politzer	181
Ear Knives Miniature Disposable	183
Ear Scissors Bellucci Micro	180
Ear Shapleigh Currettes.....	177
Ear Snare Krause	181
Ear Speculum Boucheron.....	176
Ear Speculum Gruber	176
Ear Speculum Infant	176
Ear Speculum Toynbee	176
Ear Syringe Pomeroy.....	182
Ear Syringe Apparatus Continuous	182
Eastman Retractor.....	115
Eaton Anal Speculum Chelsea	295
Echlin Rongeur	212
Echlin Rongeur Stille-Luer.....	214
Edge Blades Miniature Scalpel.....	210
Edge Curved Elevator.....	268
Edwards Bulldog Clamp	417
EKG Caliper.....	498
Electrodes For Endoscopy.....	447



Electrosurgery Instr. for OB/GYN	346-368
Elevator, Adson	245
Elevator, Ballenger Septum	188
Elevator, Bone Hohmann.....	280
Elevator, Chandler	245
Elevator, Cottle	189
Elevator, Crego.....	245,280
Elevator, Curved Edge.....	268
Elevator, Freer	188,200,270
Elevator, Frost	270
Elevator, Hohmann Bone.....	242
Elevator, Joseph Periosteal	189
Elevator, Key	245
Elevator, Lane.....	246
Elevator, Langenbeck.....	245,270
Elevator, Locke	268
Elevator, Mini Hohmann Bone	242
Elevator, Ohl	246,270
Elevator, Periosteal Sedillot.....	246
Elevator, Sayre	246,270
Elevator, Sedillot.....	244
Elevator, Seldin.....	246
Elliot Trephines	145
Elliott Obstetrical Forceps.....	369
Ellis Foreign Body Spud	137
Elschnig Cyclodialysis Spatula	138
Elschnig Fixation Forceps.....	157
Emmett Hook	112,316
Emmett Hook Laser Mini	363
Emmett Hook Quick Release.....	314
Emmett Hooks for Electrosurgery.....	353,354
Emmett Laser Hook	363
Enderectomy DeBakey Scissors	432
Endocervical Biopsy Set	345
Endocervical Curette Gusberg	320
Endocervical Curette Kevorkian-Young.....	321
Endocervical Curette Mi-Mark™ Helix	345
Endocervical Curette Sklar Mini.....	320
Endocervical Speculum Kogen.....	313
Endometrial Biopsy Set	334
Endometrial Biopsy Set Mi-Mark™.....	344
Endometrial Curette Randall.....	319
Endometrial Curettes	344
Endometrial Novak Curette.....	319
Endometrial Sampling Set Mi-Mark™.....	344

ENDOSCOPY

Endoscopic Dissecting Forceps.....	455
Endoscopic Forceps Grasping.....	456
Endoscopy Instruments	434-456
Endoscopy Instr. SklarTech 1000™.....	434-441
Endoscopy Instr. SklarTech 2000™.....	442-444

Endoscopy Instr. SklarTech 3000™.....	454-441
Endoscopy Applicator	445
Endoscopy Clip Applying Forceps.....	452
Endoscopy Grasping Forceps	453
Endoscopy Hysteroscopy Instruments	453
Endoscopy Needle Holder	445
Endoscopy Suction/Irrigation	449
Endospeculum Kogan Laser.....	362
Endospeculum Kogan for Electrosurgery	352
Engel Plaster Saw	256
Enterotome Scissors.....	29,306
Entropium Forceps Snellen	166
Enucleation Scissors	22
Enzymatic Detergent Instru-Guard	527
Enzymatic Detergent Sklar	512,520,521
Episiotomy Scissors Braun	29
Eppendorfer Biopsy Punch	341
Erhardt Lid Forceps	165
Esmarch Shears	257,292
Esmarch Tin Bullet Probe	122
Essrig Dissecting Scissors.....	12
Essrig Tissue Forceps	72
Evacuation Smoke Tube Holder	349
Evacuation Tube Holder Laser Smoke.....	361
Evacuation Tubing Smoke Disp.....	349,360
Eves Tonsil Snare.....	198
Evisceration Bunge Spoons.....	141
Excavator & Packer	267
Excavator-Curette.....	266
Exclusion Clamp DeBakey Aortic	404
Expressor Arruga Lens	132
Expressor Lens & Muscle Hook Kirby	132
Expressor Lens & Rizzuti Iris Retractor	132
Extra Capsular Forceps Fuchs	162
Extra Capsular Forceps Schweiger	162
Extra Delicate Sklarlite™ Iris Scissors.....	150
Extra Del. Sklarlite™ Strabismus Scis.....	153
Extra Heavy Forceps Kelly	303
Extraction Pliers T-C Double Action Wire	288
Extraction Retractor For Gall Bladder.....	452
Extractor Comedone.....	495
Extractor IUD	320
Extractor Murless Head	372
Extractor Pin/Wire Snap Lock.....	252
Extractor Schamberg Comedone	495
Extractor Unna Comedone	495
Extractor Wire Ring Handle T-C	252,288
Extractor Wire/Snap Lock Pin.....	289
Eye Instruments.....	128-175
Eye And Ear Manhattan Suture Fcps	159,161
Eye Dressing Forceps	77,156
Eye Dressing Forceps Bishop-Harmon	155

Eye Shield Aluminum Fox.....	174
Eye Shields Disposable	174
Eye Speculum Cook	128
Eye Speculum Knapp	129
Eye Speculum Mckinney	128
Eye Speculum Mcpherson.....	129
Eye Speculum Murdock.....	128
Eye Speculum Park-Maumenee	130
Eye Speculum Sauer	129
Eye Speculum Wiener	128
Eye Speculum Wire Kratz-Barraquer.....	128
Eye Tissue Forceps.....	77,156
Eye Weeks Speculum.....	130

F

Face Lift Scissors Aufricht	20
Farabeuf Bone Forceps	237
Farabeuf-Lambotte Bone Holding Fcps.....	237
Farabeuf Raspatories	244
Farabeuf Retractor.....	110
Farrell Applicator.....	184
Favaloro Vascular Scissors	431
Feilchenfeld Splinter Forceps	81,493
Felt And Moleskin Scissors.....	28
Felt Shears	292
Female Catheters	316
Fenestrated Grasping Forceps	437,442
Fenestrated Retractor Sklar.....	106
Fenestrated Schertl Grasping Forceps.....	437
Fenestrated Sklar Retractor.....	390
Fenzl Insertion Hook.....	143
Ferguson Bone Holding Forceps	47,238
Ferguson Scissors	29
Ferguson Scoop	125
Ferret Gouge	230
Ferris Smith Intervertebral Disc (Pituitary)	222
Ferris-Smith Forceps	72
Ferris-Smith Tissue Forceps.....	334
Fetoscope Perell.....	500
File And Rasp Fomon	233,273
File Bone.....	233,234,273
File Bone #12.....	272
File Bone #12A	272
Fine Point Splinter Forceps	81,493
Fine Stitch Scissors	151,486
Finger And Hand Retractor Hays.....	241
Finger Bandage Scissors Burnham.....	27
Finger Nail Drill Sklar	496
Finger Ring Cutters.....	496
Finochietto Needle Holder	90,324

Finochietto Needle Holder T-C	96	Forceps, Allis Grasping.....	436,440,444	Forceps, Bone Hold. Farabeuf-Lambotte ...	237
Finochietto Rib Spreader	104,385	Forceps, Allis T-C	84	Forceps, Bone Liston	275
Finochietto Scissors.....	30,392	Forceps, Allis Tissue.....	62,357	Forceps, Bonn Micro Suturing	159,489
First Rib Rongeur Dale	215	Forceps, Allis Tissue Delicate.....	63	Forceps, Bonn Tying.....	159,489
Fisher Spoon And Needle.....	138	Forceps, Allis Tissue Sklarlite™	62,284	Forceps, Bonney Tissue	73
Fisher Tonsil Knife	199	Forceps, Allis Tissue Sklarlite™ XD	63	Forceps, Botvin Iris	154,489
Fistula Probe Barr	122,298	Forceps, Allis-Adair.....	61	Forceps, Boys-Allis Tissue	61
Five-In-One Tuning Fork.....	498	Forceps, Allis-Thoms	61	Forceps, Bozeman.....	57,326
Fixation Clamp.....	438	Forceps, Diss. Grasping-Endoscopy	439	Forceps, Bozeman Dressing	296
Fixation Forceps Castroviejo	158	Forceps, Application Sklar Clamp.....	477	Forceps, Bozeman Laser.....	366
Fixation Forceps Elschmig.....	157	Forceps, Applying Bulldog Clamp.....	417	Forceps, (Braun) Schroeder Tenaculum ...	326
Fixation Forceps Graefe	78,163	Forceps, Arruga Capsule.....	79,162	Forceps, Brown Tissue	73
Fixation Forceps Green	157	Forceps, Ash Septum Straightening	192	Forceps, Champion	54,329
Fixation Forceps Iowa State	155,488	Forceps, Atraumatic Cardiovas. Dale	408	Forceps, Capsulorhexis Kraff-Utrata	162
Fixation Forceps Kuhnt.....	157	Forceps, Atraumatic DeBaKey-Derra	407	Forceps, Carmalt Splinter	81,493
Fixation Forceps Waldeau	157	Forceps, Atraumatic Tissue DeBaKey	367	Forceps, Castroviejo	77,159
Fixation Hook Guthrie	140	Forceps, Ayer Chalazion	166	Forceps, Castroviejo Capsule.....	162
Fixation Hook Scleral Twist	143	Forceps, Babcock.....	65,329	Forceps, Castroviejo Colibri.....	158,488
Fixation Pick Burch	140	Forceps, Babcock Grasping-Endoscopy ...	444	Forceps, Castroviejo Fixation	158
Fixation Rings	131	Forceps, Babcock Laser Black Sklar ...	299,366	Forceps, Castroviejo Suture	83,159
Fixation Rings Casanova.....	131	Forceps, Babcock T-C.....	84	Forceps, Chalazion Baird	165
Fixation Rings Flieringa	131	Forceps, Bainbridge.....	382	Forceps, Chalazion Spencer	165
Fixation Rings Flieringa-Legrand.....	131	Forceps, Ballenger Sponge	86,504	Forceps, Chandler Iris	77
Fixation Rings McNeil-Goldman	131	Forceps, Ballenger Tonsil Seizing	202	Forceps, Cilia Littauer.....	163
Flash Sterilization Instrument Trays	506	Forceps, Barraquer Cilia.....	82,163	Forceps, Cilia Ziegler	163
Flieringa Fixation Rings	131	Forceps, Barrett Placenta	58,374	Forceps, Clark Artery.....	334
Flierings-Legrand Fixation Rings	131	Forceps, Barrett Tenaculum	60,326	Forceps, Clayman.....	167
Foerster Sponge Forceps	86	Forceps, Barton Obstetrical	369	Forceps, Clemetson.....	54,328
Fomon Nasal Chisel	194	Forceps, Basket Blunt Nose Arthroscopy ...	459	Forceps, Clip Applying - Endoscopy.....	452
Fomon Rasp And File	233,273	Forceps, Basket Scoop Nose Arthro.	459	Forceps, Cobra Grasp.-Endosc. ...	436,437,443
Fomon Retractor.....	112,196	Forceps, Basket Side Bite Arthroscopy	459	Forceps, Colibri Corneal Utility	154
Fomon Saber Back Scissors	20,191	Forceps, Bechert-McPherson Tying	160	Forceps, Coller Hemostatic	44
Fomon Scissors.....	20,190	Forceps, Bengolea.....	377	Forceps, Collin-Duval Lung Grasping.....	126
Forcep And Needle Holder Greene	169	Forceps, Bergh Cilia	82,163	Forceps, Collins.....	64
		Forceps, Berke Ptois.....	165	Forceps, Collins Tongue Seizing.....	65,504
		Forceps, Bierer Ovum.....	58,373	Forceps, Colver-Coakley	61
		Forceps, Billroth.....	59,333	Forceps, Cooley Anastomosis	423
		Forceps, Biopsy - Endoscopy	453	Forceps, Cooley Coarctation	422
		Forceps, Biopsy Punch-Endoscopy.....	438	Forceps, Cooley Patent Ductus	422
		Forceps, Biopsy Spoon Jaws-Endoscopy ..	438	Forceps, Cooley Satinsky Anastomosis	423
		Forceps, Bipolar Coagulation-Endoscopy ..	448	Forceps, Cooley Vascular.....	422
		Forceps, Bishop-Harmon.....	78	Forceps, Cooley Vascular Tissue	394,426
		Forceps, Bishop-Harmon Iris	155	Forceps, Corey Ovum.....	58,373
		Forceps, Blake Ear	180	Forceps, Corneal Util. Troutman-Barraq....	487
		Forceps, Blake Gallstone.....	49	Forceps, Crafoord.....	380
		Forceps, Blakesley Biopsy-Endoscopy.....	438	Forceps, Craig	64,327
		Forceps, Blumenthal	276	Forceps, Crile Duct	49
		Forceps, Bonaccolto	79	Forceps, Crile Gall Duct.....	52
		Forceps, Bonaccolto Utility	161	Forceps, Crile Hemostatic	40
		Forceps, Bond Placenta	58,374	Forceps, Crile Hemostatic Sklarlite™	40
		Forceps, Bone Compression	239,285	Forceps, Crile Hemostatic Sklarlite™ XD	40
		Forceps, Bone Cutting McIndoe	191	Forceps, Cushing Delicate.....	69

FORCEPS

Forceps.....	38-65
Forceps, Abramson-Allis.....	61,327
Forceps, Adair Breast Tenaculum	64
Forceps, Adson.....	45,66,69,371
Forceps, Adson Bayonet	76
Forceps, Adson Delicate.....	67
Forceps, Adson Dressing	66
Forceps, Adson Micro.....	69
Forceps, Adson Sklar Blue™.....	356
Forceps, Adson Sklarlite™	66
Forceps, Adson Sklarlite™ XD	67,473
Forceps, Adson Tissue	66
Forceps, Adson-Brown	66,69
Forceps, Alligator Ear Micro	178
Forceps, Alligator Grasping	439
Forceps, Allis	56,327



Forceps, Cutter Littauer (Titanium Nitride) 261	Forceps, Foerster Sponge86	Forceps, Hemostatic Sklar Special.....382
Forceps, Dandy Scalp47	Forceps, Forester Iris.....155,488	Forceps, Henrotin Vulsellum.....55,331
Forceps, Davis.....47,201	Forceps, Foss Intestinal.....51	Forceps, Hildebrandt56,330
Forceps, De Alvarez56	Forceps, Francis Chalazion165	Forceps, Holder Weisenbach505
Forceps, De Lee Obstetrical371	Forceps, Fuchs Extra Capsular162	Forceps, Holding Kern Bone.....282
Forceps, DeBakey Atraumatic.....398,413,414	Forceps, Heavy Duty Grasp.-Endosc. 439,443	Forceps, Hunt Chalazion165
Forceps, DeBakey Atraumatic Intestinal.....438	Forceps, Gall Bladder Judd-De Martel125	Forceps, Ingrown Toe Nail.....265
Forceps, DeBak. Atraum. Periph. Vsl..397,400	Forceps, Gall Bladder Traction Lovelace....126	Forceps, Inserting IOL Clayman167
Forceps, DeBak. Atraum. Tis...75,317,393,394	Forceps, Gavin Miller Bayonet.....51	Forceps, Inserting Shepard IOL.....167
Forceps, DeBakey Atraum. Vascular...395,396	Forceps, Gelpi-Lowrie.....56,330	Forceps, Intestinal Dorsey438
Forceps, DeBakey-Bahnsen Atraumatic.....411	Forceps, Gemini Delicate50,375	Forceps, Intestinal Glassmann441
Forceps, DeBakey Bainbridge Vascular400	Forceps, Gerald69	Forceps, Iowa Membrane59,373
Forceps, DeBakey Bronchus419	Forceps, Gill.....78,154,487	Forceps, Iris Chandler155
Forceps, DeBakey Diss. And Grasping436	Forceps, Gill-Hess Iris154	Forceps, Iris Gill (Chandler).....487
Forceps, DeBakey Diss. And Ligature410	Forceps, Girard Corneal Scleral158	Forceps, Iris Gill-Hess487
Forceps, DeBakey Halsted Mosquito409	Forceps, Girard Tying160	Forceps, Jackon Alligator Grasping.....297
Forceps, DeBakey Intestinal.....441,444	Forceps, Glover401,402	Forceps, Jacobs Vulsellum.....55,333
Forceps, DeBakey Pean.....409	Forceps, Gordon Catheter74,391	Forceps, Jacobson Micro.....74
Forceps, DeBakey Pediatric418	Forceps, Gradle Cilia163	Forceps, Jacobson Mosquito Delicate.....47
Forceps, DeBakey T-C84	Forceps, Graefe.....79,156	Forceps, James74,283
Forceps, Delee Uterine.....54,328	Forceps, Graefe Fixation78,163	Forceps, Jameson Recession164
Forceps, Delicate Allis Tissue.....327	Forceps, Graefe Iris77	Forceps, Jansen Nasal76,187
Forceps, Dingmann247	Forceps, Grasping - Endoscopy ..436,443,453	Forceps, Jansen-Middleton Septum192
Forceps, Dissecting Semb390	Forceps, Grasp. And Diss.-Endosc.436,437	Forceps, Jarcho Tenaculum326
Forceps, Dolphin Dissecting436	Forceps, Grasping Babcock-Endoscopy440	Forceps, Javerts Placenta58,373
Forceps, Douglass Cilia.....82,163	Forceps, Grasping Biopsy-Endoscopy438	Forceps, Jewelers Style.....80,167,490
Forceps, Doyen48	Forceps, Grasping - Endoscopy455,456	Forceps, Johns Hopkins Gall Bladder53
Forceps, Doyen Vulsellum.....55	Forceps, Grasping Hartmann Alligator178	Forceps, Johns Hopkins Mosquito.....45
Forceps, Dressing.....70	Forceps, Grasping Pennington441	Forceps, Jones45
Forceps, Dressing Laser Black.....299	Forceps, Grasping With Pin.....439	Forceps, Kalt Capsule162
Forceps, Dressing Sklarlite™70,474	Forceps, Graves Tenaculum59,327	Forceps, Kantrowitz Tissue391
Forceps, Duck Bill Diss. And Grasping.....443	Forceps, Gutglass Cervix56,330	Forceps, Kazanjian Nasal.....191
Forceps, Duplay Tenaculum.....59,326	Forceps, Hale Obstetrical371	Forceps, Kelly41,201
Forceps, Duval Grasping440,444	Forceps, Halsted Mosquito Hemostatic.....38	Forceps, Kelly Extra Heavy303
Forceps, Elliott Obstetrical.....369	Forceps, Harmon157	Forceps, Kelly Placenta58
Forceps, Elschmig Fixation.....157	Forceps, Harms Tying159	Forceps, Kern Bone Holding.....237,238
Forceps, Endoscopy Hysteroscopy453	Forceps, Harrington53,384	Forceps, Kidney Stone Randall127
Forceps, Erhardt Lid165	Forceps, Harrington-Mayo Bayonet.....73	Forceps, Kieland Obstetrical.....370
Forceps, Essrig Tissue72	Forceps, Harrington-Mayo Bayonet Tiss. ...391	Forceps, Kieland-Luikart Obstetrical.....370
Forceps, Eye Dressing77,156	Forceps, Hartman-Herzfeld180	Forceps, King.....74,283,290
Forceps, Eye Dressing Bishop-Harmon155	Forceps, Hartmann Alligator Action178	Forceps, Kirby Iris.....156
Forceps, Eye Tissue77,156	Forceps, Hartmann Mosquito Hemostatic42	Forceps, Knight Dressing186
Forceps, Farabeuf Bone237	Forceps, Hartmann Mosquito Sklarlite™42	Forceps, Lagenbeck Bone Holding.....239
Forceps, Feilchenfeld Splinter81,493	Forceps, Hartmann Punch Action.....178	Forceps, Lahey45,48
Forceps, Fenestrated Grasping437	Forceps, Healy Suture83,119	Forceps, Lahey Gall Duct123
Forceps, Ferguson.....47,238	Forceps, Heaney (Ballentine)57,329,331	Forceps, Lahey Traction334,383
Forceps, Ferris-Smith72	Forceps, Heaney-Kanter.....329	Forceps, Lambert Chalazion.....165,166
Forceps, Fixation Green157	Forceps, Heath Chalazion165	Forceps, Lambotte Bone Holding237
Forceps, Fixation Iowa State155,488	Forceps, Hegenbarth Clip Applying.....183,20	Forceps, Lane Bone Holding237
Forceps, Fixation Kuhnt.....157	Forceps, Heiss.....377	Forceps, Lane Tissue72
Forceps, Foerster Grasping.....441	Forceps, Hemostatic Negus379	Forceps, Laser Adson Tissue367

Forceps, Laser Allis	367	Forceps, Mosquito Micro	47	Forceps, Schweiger Extra Capsular	162
Forceps, Laufe-Barton-Kieland.....	369	Forceps, Moynihan	50,123	Forceps, Schweizer	54,328
Forceps, Laser Champion Grasping.....	366	Forceps, Nasal Hartmann.....	186	Forceps, Schweizer Sklar Blue™	357
Forceps, Laser Clemetson.....	368	Forceps, Needle Nose Grasping	437	Forceps, Scudder	51
Forceps, Laser Graves Tenaculum	366	Forceps, Non-Traumatic Allis	284	Forceps, Segond (Collin)	59,333
Forceps, Laser Laufe Uterine Polyp	368	Forceps, Noyes Alligator.....	187	Forceps, Selman.....	391
Forceps, Laser Rochester-Pean	367	Forceps, Nugent Utility	161	Forceps, Semb Bone Holding.....	238
Forceps, Laser Schroeder Tenaculum	366	Forceps, O'Brien-Elschnig.....	157,488	Forceps, Semb Dissecting.....	53
Forceps, Laser Schweizer	368	Forceps, O'Connor Iris.....	156,488	Forceps, Semkin Dressing.....	73
Forceps, Laser Tuttle/Singley	367	Forceps, Obstetrical Dewey.....	372	Forceps, Septum Knight	186
Forceps, Laufe Divergent Outlet Ob.	372	Forceps, Obstetrical McLane-Tucker.....	371	Forceps, Shaaf Foreign Body	161
Forceps, Laufe Uterine Polyp	54,328	Forceps, Ob. McLane-Tucker-Luikart.....	370	Forceps, Shallcross	48,124
Forceps, Laufe Uter. Polyp Sklar Blue™ ..	357	Forceps, Ockerblad	51	Forceps, Simcoe Nucleus.....	158
Forceps, Lawrence	379	Forceps, Overholt	53,381	Forceps, Simpson Obstetrical.....	371
Forceps, Lawton	329	Forceps, Overholt-Geissendoerfer	381	Forceps, Simpson-Luikart Obstetrical.....	370
Forceps, Leriche.....	376	Forceps, Peanut Sponge.....	86,504	Forceps, Sklar Blue™	357
Forceps, Lester Conjunctival	78,157	Forceps, Peet Splinter	494	Forceps, Sklar Blue™ Bozeman.....	356
Forceps, Lewin Bone	285,239	Forceps, Penner	248	Forceps, Sklar Blue™ Champion Grasping..	356
Forceps, Liston Bone.....	211,212,274	Forceps, Pennington Grasping.....	383,444	Forceps, Sklar Blue™ Clemetson.....	357
Forceps, Littauer Cilia.....	82	Forceps, Phaneuf	57,330,328	Forceps, Sklar Blue™ Tuttle/Singley	357
Forceps, Littauer Cutting	260,261	Forceps, Physicians Splinter	494	Forceps, Sklar Hemorrhoidal	293
Forceps, Littauer Ear	178	Forceps, Piper Obstetrical	369	Forceps, Sklar Intestinal	52
Forceps, Littauer Nasal.....	187	Forceps, Plain Splinter With Magnifier.....	81	Forceps, Sklar Litegrip™ Adson	68
Forceps, Locke Phalangeal	240,285	Forceps, Plate And Bone Holding.....	239	Forceps, Sklar Litegrip™ Adson-Brown.....	68
Forceps, Long.....	328	Forceps, Platt Tendon Transplantation.....	247	Forceps, Sklar Litegrip™ Bishop-Harmon	68
Forceps, Lordon Chalazion.....	166	Forceps, Platypus Nail.....	265	Forceps, Sklar Litegrip™ Iris	68,156
Forceps, Lovelace Grasping.....	384	Forceps, PNA	274	Forceps, Sklar Litegrip™ T-C Adson-Brown ..	68
Forceps, Lucae Bayonet.....	76,180	Forceps, Potts-Smith	74,367,391,394	Forceps, Sklar Rankin	49
Forceps, Luikart Obstetrical.....	370	Forceps, Potts-Smith for Electrosurgery....	356	Forceps, Sklar Tissue	79
Forceps, Lung Grasping Duval	126	Forceps, Pratt	64	Forceps, Sklar Tubing.....	86
Forceps, Magill Catheter.....	65	Forceps, Preston Ligamentum Flavum.....	248	Forceps, Sklar-Allis.....	61
Forceps, Manhattan Ear And Eye Suture...161		Forceps, Prince Advancement.....	79,164	Forceps, Sklar-Angular Littauer Cutting.....	261
Forceps, Marc Grasping	441	Forceps, Prince Trachoma	166	Forceps, Sklar-Taper Littauer Cutting.....	261
Forceps, Marcuse Tubing	86	Forceps, Providence Hospital.....	45	Forceps, Sklarlite™ Adson	473
Forceps, Maumenee Colibri Corneal ...158,488		Forceps, Randall Stone	49	Forceps, Sklarlite™ Allis Tissue	474
Forceps, Mayo-Blake Gallstone.....	49	Forceps, Rankin Hemostatic.....	44	Forceps, Sklarlite™ Crile Hemostatic.....	470
Forceps, Mayo-Collins	110	Forceps, Rectus Superior Nugent	164	Forceps, Sklarlite™ Dressing	474
Forceps, Mayo-Robson	48	Forceps, Rhoton Micro Suture.....	487	Forceps, Sklarlite™ Ingrown Toe Nail	265
Forceps, McCullough Utility	79,161	Forceps, Roberts	378	Forceps, Sklarlite™ Kelly Hemostatic.....	470
Forceps, McIndoe Bone Cutting	276	Forceps, Rochester Carmalt.....	44	Forceps, Sklarlite™ Littauer Cutting	260
Forceps, McLane-Tucker-Kieland Ob.....	371	Forceps, Rochester Ochsner.....	44	Forceps, Sklarlite™ Mixter.....	471
Forceps, McPherson Tying.....	159	Forceps, Rochester Pean	43	Forceps, Sklarlite™ Rochester-Pean	472
Forceps, Michel Applying And Remov. .83,119		Forceps, Rochester Pean Sklarlite™	43,472	Forceps, Sklarlite™ Tissue.....	473
Forceps, Michel Tissue.....	72	Forceps, Rowland Bone	211,276	Forceps, Snellen Entropium	166
Forceps, Micro	478	Forceps, Ruskin Liston	275	Forceps, Splinter Fine Point	81,493
Forceps, Micro Alligator Ear	180	Forceps, Ruskin Splitting.....	211,275	Forceps, Splinter Plain With Magnifier.....	493
Forceps, Micro Iris Suturing McPherson....159		Forceps, Russian Tissue	73	Forceps, Splinter Williams (Stieglitz)	494
Forceps, Micro Rhoton	487	Forceps, Sawtell Tonsil.....	201	Forceps, Staude Tenaculum.....	65,326
Forceps, Micro Suture Tying.....	83	Forceps, Schaaf Foreign Body	78	Forceps, Sterilizer.....	504
Forceps, Micro Sklar Micro-Grip™	482,483	Forceps, Schertl Fenestrated Grasping.....	437	Forceps, Stille Tissue	72
Forceps, Mini Blumenthal	276	Forceps, Schnidt.....	380	Forceps, Stille-Horsley Bone Cutting.....	211
Forceps, Mixer	46,124,303	Forceps, Schroeder Tenaculum	59,317	Forceps, Strabismus	78
Forceps, Mosquito Delicate-Long.....	375	Forceps, Schroeder Vulsellum.....	60,333	Forceps, Struycken Cutting	187



Forceps, Sup. Rectus Tennant-Troutman ..164
 Forceps, Suture Castroviejo489
 Forceps, Suturing Sauer.....161
 Forceps, T-C Adson Brown85
 Forceps, T-C Adson Dressing85
 Forceps, T-C Babcock.....285
 Forceps, T-C DeBakey334
 Forceps, T-C Dressing.....85
 Forceps, T-C Potts-Smith Dressing85
 Forceps, Takahashi186
 Forceps, Teale Vulsellum60,327
 Forceps, Tenaculum64
 Forceps, Tenac. Sklar Blue™ Schroeder ...356
 Forceps, Tendon Larsen.....248
 Forceps, Tennant Tying.....160,489
 Forceps, Thompson Mosquito45
 Forceps, Thoms-Gaylor Biopsy298
 Forceps, Thorpe Corneoscleral77,161
 Forceps, Tissue71,72,264
 Forceps, Tissue Allis.....284
 Forceps, Tissue Bonney334
 Forceps, Tissue Delicate71
 Forceps, Tissue Ferris-Smith.....334
 Forceps, Tissue Sklar Non-Slip74
 Forceps, Tissue Sklarlite™71
 Forceps, Tissue Sklarlite™ XD.....473
 Forceps, Tivnen Tonsil Seizing.....202
 Forceps, Tonsil Colver-Coakley.....202
 Forceps, Tonsil Schnidt201
 Forceps, Tonsil Seizing Craig.....202
 Forceps, Tonsil White.....202
 Forceps, Troutman-Barraq. Corneal Util.....154
 Forceps, Tubing St. Vincent86
 Forceps, Tucker Hallux.....240
 Forceps, Tumor Grasping.....478
 Forceps, Tuttle/Singley73
 Forceps, Tying Tonsil Seizing.....202
 Forceps, Tying Bechert-McPherson489
 Forceps, Tying Kelman-McPherson160,489
 Forceps, Utility Colibri Corneal487
 Forceps, Utility Girard Corneal158
 Forceps, Utility Wills Hospital161
 Forceps, Van Bruen Sequestrum239
 Forceps, Van Buren Plaster.....258
 Forceps, Vanderbilt University.....378
 Forceps, Varco49,124
 Forceps, Vascular Strel.....432
 Forceps, Verbrugge Bone Holding238
 Forceps, Virtus Splinter494
 Forceps, Von Graefe Iris.....155
 Forceps, Vulsellum Doyen.....331
 Forceps, Vulsellum Schroeder.....332

Forceps, Wachenfeldt Clip.....83,120
 Forceps, Waldeau Fixation157
 Forceps, Walton Suture160
 Forceps, Weingartner Ear.....180
 Forceps, Weis Chalazion.....166
 Forceps, White.....64
 Forceps, Wilde Ear76,180
 Forceps, Wilde Nasal.....187
 Forceps, X-Action Jackson204
 Forceps, Young Tongue Seizing65
 Forceps, Zeigler Cilia.....82
 Foreign Body Davis Spud135
 Foreign Body Forceps Schaaf78
 Foreign Body Instrument Quire.....181
 Foreign Body Laforce Spud135
 Foreign Body Loop & Junior Magn. Probe...135
 Foreign Body Needles137
 Foreign Body Remover Bailey135
 Foreign Body Spud Alvis137
 Foreign Body Spud Ellis137
 Foreign Francis Body Spud135
 Foreign Shaaf Body Forceps161
 Forester Grasping Forceps.....441
 Forester Iris Forceps.....155,488
 Fork Tuning Five-In-One.....498
 Fork Tuning Sklar Aluminum Alloy.....182
 Foss Biliary Duct Retractor116
 Foss Intestinal Forceps.....51
 Fossa Glenoid Retractor.....243
 Fox Aluminum Eye Shield.....174
 Fox Dermal Curette281,496
 Francis Chalazion Forceps165
 Francis Foreign Body Spud135
 Frazier Blunt Dissector246
 Frazier Suction Tube117
 Frazier Tissue Hook.....112
 Freer Chisel193,195
 Freer Dissector246
 Freer Elevator200,270
 Freer Septum Elevator.....188
 Freer Septum Gouge195
 Freer Septum Knife.....188
 Freeway Graves Vaginal Speculum307
 Freeway Graves Vaginal Spec. Laser360
 Freeway Vaginal Speculum Sklar Blue™ ...349
 Freidman Bone Rongeur218,277
 Fritch Retractor114
 Frost Elevator270
 Frykholm Rongeur212
 Fuchs Extra Capsular Forceps162

G

Gag For Mouth,Doyen-Jansen197
 Gag For Mouth, Jennings197
 Gag For Mouth, Wesson.....197
 Gall Bladder and Kidney Instruments ...123-127
 Gall Bladder Extraction Retractor452
 Gall Bladder Forceps, Johns Hopkins53
 Gall Bladder Forceps, Judd-De Martel125
 Gall Bladder Traction Forceps, Lovelace.....126
 Gall Bladder Varco Forceps.....124
 Gall Duct Forceps Crile.....52
 Gall Duct Forceps Lahey123
 Gall Duct Forceps Lower123
 Gall Duct Forceps Moynihan123
 Gall Duct Mixer Forceps124
 Gall Stone Collector.....451
 Gallstone Forceps Blake.....49
 Gallstone Forceps Mayo-Blake.....49
 Gallstone Scoop Desjardin125
 Gallstone Scoop Mayo.....125
 Garrigue Weighted Vaginal Speculum.....310
 Gauze Scissors USA Pattern.....28,259,290
 Gavin Miller Bayonet Forceps.....51
 Gaylor Biopsy Punch343
 Gelhorn Biopsy Punch.....343
 Gelpi-Lowrie Forceps.....56,330
 Gelpi Retractor.....100
 Gemini Forceps Delicate Right Angle.....50,375
 Genito-Urinary Instruments301-306
 Gerald Forceps69
 Gerster (Lowman) Turnbuckle236
 Gerzog (Sexton) Ear Knife.....181
 Gerzog Bone Mallet232,278
 Gerzog Nasal Speculum.....186
 Gigli Saw Guide Bailey250
 Gigli Saw Handles250
 Gigli Saw Wire250
 Gill (Chandler) Iris Forceps.....154,487
 Gill Corneal Knife.....136
 Gill Forceps.....154,487
 Gill-Hess Iris Forceps154,487
 Gill Iris Forceps.....78
 Gillies Skin Hook.....112
 Gills/Welsh Lens Loop139
 Girard Corneal Scleral Forceps158
 Girard Corneal Utility Forceps158
 Girard Tying Forceps160
 Glabellar Rasp Aufrecht.....195
 Glassman Thin Point Dissecting Scissors ...190
 Glassmann Intestinal Forceps441
 Glenoid Fossa Retractor.....243

Glover Anastomosis Clamp	406	Grasp. Forceps, (Fundus) - Endo.....	439,443	H	Haight-Finocchio Rib Retractor	104,386
Glover Bulldog Clamp	416	Grasping Forceps, Hartmann Alligator	178		Haimovici Scissors.....	30
Glover Curved Clamp	406	Grasping Forceps, Jackson Alligator	297		Hajek Septum Chisel	195
Glover Forceps	401,402	Grasping Forceps, Laser Champion.....	366		Hale Obstetrical Forceps	371
Gluck Rib Shears.....	388	Grasping Forceps, Lovelace - Endoscopy...384			Halle Nasal Speculum	185
Goelet Retractor	110	Grasping Forceps, Marc - Endoscopy	441		Hallux Forceps Tucker.....	240
Goldman-Fox Scissors	19	Grasping Forceps, Needle Nose	437		Halsey Needle Holder.....	88
Goldstein Retractor.....	101,133,491	Grasping Forceps, Pennington.....	441		Halsey Needle Holder T-C.....	93,95
Golf Stick Knife	270	Grasp. Forceps, Schertl Fenestr.- Endo.....	437		Halsted Mosquito Forceps DeBakey	409
Gonitomy Barkanan Knife.....	136	Grasp. Forceps, Stand. Pattern Hartmann.....	178		Halsted Mosquito Fcps Sklarlite™ XD.....	39,469
Goodell Uterine Dilator	319	Grasping Forceps, Tumor	478		Halsted Mosquito Hemostatic Forceps...38,469	
Gordon Catheter Forceps.....	74,391	Grasping Forceps, With Pin - Endoscopy...439			Hammer Buck Neurological.....	497
Gosset (Nelson) Retractor	102	Grasp. Forceps, Dolphin Diss.- Endo.....	437		Hammer Rabiner Neurological	497
Gouge Alexander Mastoid	229	Grasping Forceps, Pennington	383,444		Hammer Taylor Percussion	497
Gouge Army Pattern	226	Grasping Scissors Allis - Endoscopy	440		Hand And Finger Retractor Hays.....	241
Gouge Bone West	195	Grasping Tip Bipolar - Endoscopy.....	448		Handle For Axial - Endoscopy	446
Gouge Capener Lamina	230	Graves Laser Wide View Vaginal Spec.....	360		Handle For Bill Traction	372
Gouge Cobb Type Spinal	229	Graves Tenaculum Forceps	59,327		Handle For Endoscopy	440
Gouge Ferret	230	Graves Tenaculum Forceps Laser	366		Handle For Specialty Surgical Blades	210
Gouge Freer Septum	195	Graves Type Speculum Disposable	530		Handle For Luikart-Bill Traction	372
Gouge Hibbs.....	228	Graves Vaginal Speculum	307		Handle For Saw Gigli.....	250
Gouge Lamina	230	Graves Vaginal Speculum Freeway	307		Handles For Scalpel Blades	208
Gouge Lexer Mini	230	Graves Vaginal Speculum Laser	358,360		Hank Uterine Dilator	318
Gouge Smith Peterson	226	Graves Vaginal Spec. Sklar Blue™346,348,349			Harken Rib Spreader	103,386
Gouge Stille Type	227	Graves Vaginal Spec. Wide View Pattern ...307			Harmon Forceps.....	157
Gradle Cilia Forceps.....	163	Graves Vag. Wide View Spec. Sklar Blue™349			Harms Impactor	231
Gradle Scissors	152,486	Green Retractor	106		Harms Tying Forceps	159
Graduated Probe	449	Green Spatula.....	138		Harrington Clamp Forceps.....	384
Graefe Cataract Knives	134	Green Strabismus Hook	140		Harrington Forceps	53
Graefe Fixation Forceps	78,157,163	Greene Needle Holder And Forceps	169		Harrington Retractor	116,389
Graefe Forceps.....	79,156	Greene Uterine Curette	320		Harrington Splanchnic Retractor.....	389
Graefe Iris Forceps.....	77	Grieshaber Type Keratomes.....	134		Harrington Thoracic Retractor	116
Graefe Muscle Hook.....	140	Groove And Eye Tendon Passing Probe.....	249		Harrington-Mayo Bayonet Forceps.....	73
Graether Collar Button.....	143	Gross Hook And Spoon	181		Harrington-Mayo Bayonet Tissue Fcps	391
Graether Collar Button Micro-Iris Retr.	173	Gruber Ear Speculum	176		Harrington-Mixer Clamp.....	390
Graft. Knife Humby Skin Potter Bodenham.....	496	Guide Adjustable Angle	255		Harris - Sinsky Lens Manipulating Hook.....	142
Grasper Atlantic With Ratchet - Arthro.	460	Guide Borchard Wire	253		Harris Wire Knot Tightener	253
Grasper Maxi With Locking Screw-Arthro....	460	Guide Clayman.....	141		Hartman (Mosher) Tonsil Punch.....	200
Grasper Pacific - Arthroscopy.....	460	Guide Colangiogram - Endoscopy.....	448		Hartman-Herzfeld Forceps	180
Grasping Forceps, Alligator - Endoscopy...439		Guide Instrument Trouble Shooting.....	515		Hartmann Alligator Grasping Forceps	178
Grasping Forceps, Allis - Endoscopy...436,444		Guide Knot - Endoscopy.....	445		Hartmann Mosquito Forceps	42
Grasp. Forceps, And Duck Bill-Endo.....	437,443	Guides Catheter.....	303		Hartmann Mosq. Forceps Sklarlite™	42,469
Grasp. Forceps, And Grasp. Bill-Endo.....	437,443	Gusberg Endocervical Curette.....	320		Hartmann Nasal Forceps.....	186
Grasping Forceps, Babcock-Endo.....	440,444	Gusberg Hysterectomy Clamp.....	56,330		Hartmann Punch Action Forceps.....	178
Grasping Forceps, Biopsy - Endoscopy	438	Gutglass Hysterectomy Clamp.....	56,330		Hartmann Rongeur	216
Grasping Forceps, Campion Sklar Blue™...356		Guthrie Cervix Forceps	56,330		Hassan Trocar	450
Grasp. Forceps, Cobra - Endo.....	436,437,443	Guthrie Double Hook	112		Hays Hand And Finger Retractor.....	241
Grasp. Fcps, Diss. DeBak.-Endoscopy	436	Guthrie Fixation Hook	140		Head Extractor Murless	372
Grasping Forceps, Duval - Endo.....	440,444	Gutmann Vaginal Speculum	309		Head Mirror.....	498
Grasping Forceps, Endoscopy - Endo.....	453	Gynecological Instruments	307-374		Headband Leather Jefferson	498
Grasp. Forceps, Fenestrated - Endo...437,443		Gynecology Biopsy Forceps.....	335-343			
Grasp. Forceps, Foerster - Endoscopy.....	441	Gynecology Electrosurgical Instruments	346			
		Gynecology Laser Instrumentation	358			

- Infant Lachrymal Dilator144
 Inge Retractor116,240
 Inge Spreader288
 Ingrown Baker Nail Cutter.....267
 Ingrown Nail Instrument.....267
 Ingrown Nail Splitting Scissors29,265
 Ingrown Toe Nail Forceps.....265
 Injection & Irrigation For Needle449
 Injection Cannula Air.....173
 Inserting Forceps Shepard I-IOL167
 Insertion Hook Fenzl.....143
 Insertion Hook Tennant Anchor Lens142
 Instru-Guard One-Step Sklar526
 Instru-Guard Sklar Instrument Detergent.....527
 Instrument Cleaning Brush509,514
 Instrument Holder Bunt.....505
 Instrument Identification & Protectors.....501
 Instrument Ingrown Nail.....267
 Instrument Quire Foreign Body.....181
 Instrument Rack Saunders505
 Instrument Sterilizing Tray506
 Instrument Sterilizing Tray Comfort Grip™ .506
 Instrument Stringers505
 Instrument Trouble Shooting Guide.....515
 Instrument Weinstein Rack.....505
 Instruments Biopsy Universal Style343
 Instruments Micro-Cut Univ. Style Biopsy ...343
 Internal Delee Pelvimeter374
 Intervertebral Disc Rongeur (Pituitary)211
 Intervertebral Disc Wilde Rongeur223
 Intervertebral Ferris Smith Disc (Pituitary)...222
 Intervertebral Rongeur Zielke223
 Intestinal Clamp Allen48
 Intestinal Clamp O'Hanlon48
 Intestinal Clamp Pean.....48
 Intestinal DeBakey Forceps.....441,444
 Intestinal Forceps DeBakey Atraumatic.....438
 Intestinal Forceps Dorsey438
 Intestinal Forceps Foss.....51
 Intestinal Forceps Sklar52
 Intestinal Glassman Forceps441
 Intima Dissectors Lemmon432
 Introducer Sphere Carter164
 Introducing Gordon Catheter Forceps391
 Iodine Cup508
 IOL Inserting Forceps Clayman.....167
 Iowa Membrane Forceps59,373
 Iowa State Fixation Forceps155
 Iridectomy Scissors Noyes149,485
 Iris Forceps Bishop-Harmon155
 Iris Forceps Botvin154,489
 Iris Forceps Chandler77,78,155
 Iris Forceps Forester.....155,488
 Iris Forceps Gill.....78
 Iris Forceps Gill (Chandler).....154,487
 Iris Forceps Gill-Hess154,487
 Iris Forceps Graefe77
 Iris Forceps O'Connor.....156
 Iris Forceps Sklar Litegrip™68,156
 Iris Forceps Stevens155
 Iris Forceps Von Graefe.....155
 Iris Hook.....143
 Iris Hook Clayman143
 Iris Hook Laser.....363
 Iris Hook Micro Sinsky141
 Iris Hook Quick Release314
 Iris Hook Sklar Blue™354
 Iris Hook Tyrell.....112,140
 Iris Kirby Forceps.....156
 Iris Knapp Scissors149
 Iris Kuglen Hook & Lens Manipulator142
 Iris Maxi Hook Sklar Blue™354
 Iris McGannon Retractor.....140
 Iris Micro Suturing Forceps Mcpherson159
 Iris Micro-Miniature Scissors.....149,484
 Iris Nugent Hook140
 Iris O'Connor Forceps.....488
 Iris Rizzuti Retractor & Lens Expressor132
 Iris Scissors (Standard)14,150
 Iris Scissors Angular13
 Iris Scissors Barraquer-Dewecker149,485
 Iris Scissors Delicate15,150
 Iris Scissors Dewecker149,485
 Iris Scissors Micro-Cut Sklarhone™37
 Iris Scissors Micro-Miniature.....149
 Iris Scissors Probe Point Angular149
 Iris Scissors Ribbon18,152
 Iris Scissors Sklar Edge™ T-C35
 Iris Scissors Sklarcut™33
 Iris Scissors Sklarlite™14,150,463
 Iris Scissors Sklarlite™ Sklarcut™33
 Iris Spatula Smith-Fisher138
 Irrigating Simcoe/Aspirating Cannula173
 Irrigation Cannula449
 Irrigation Tube/Suction.....450
 Irrigation/Suction Cannula449
 IUD Extractor320
 Ives Rectal Speculum (Fansler).....293,294,295
- J**
- Jackson Alligator Grasping Forceps.....297
 Jackson Laser Retractor.....368
 Jackson Tenaculum111,205
 Jackson Tracheal Retractor.....111,205
 Jackson Vaginal Retractor.....311
 Jackson Vaginal Retractor Sklar Blue™353
 Jackson X-Action Forceps204
 Jacobs Vulsellum Forceps.....55,333
 Jacobson Micro Forceps.....74
 Jacobson Micro Needle Holder.....91
 Jacobson Mosquito Forceps Delicate.....47
 Jacobson Needle Holder T-C97
 Jacobson Spring Handle Scissors31
 Jaeger Keratomes134
 Jaeger Lid Plate.....132
 Jaffe Lens Manipulating Hook142
 James Forceps74,283
 Jameson Muscle Hook140
 Jameson Recession Forceps164
 Jansen Nasal Forceps76,187
 Jansen-Middleton Septum Forceps.....192
 Jansen Self-Retaining Retractor.....101
 Jarcho Tenaculum Forceps326
 Javerts Placenta Forceps58,373
 Jefferson Leather Headband498
 Jennings Mouth Gag.....197
 Jewelers Style Forceps.....80,167,490
 Johns Hopkins Bulldog Clamp.....75,416
 Johns Hopkins Gall Bladder Forceps53
 Johns Hopkins Mosquito Forceps.....45
 Johnson Needle Holder90
 Jones Cross Action Towel Clamp.....87,207
 Jones Forceps45
 Joseph Bone Saw.....192,249,282
 Joseph Knife193
 Joseph Periosteal Elevator189
 Joseph Rasp.....233,273
 Joseph Scissors.....20,190
 Joseph Skin Hook.....112,196
 Jr. Lambotte Osteotome279
 Judd-DeMartel Gall Bladder Forceps125
 Judd-Masson Blad. And Suprapubic Retr...304
 Junior Magn. Probe & Foreign Body Loop...135
- K**
- K-Wire Driver286
 Kalt Capsule Forceps162
 Kalt Needle Holder.....168
 Kantrowitz Clamp.....50
 Kantrowitz Tissue Forceps391
 Kay Aorta Clamp.....407
 Kazanjian Nasal Forceps.....191
 Kelly-Adson Scissors13,306,323
 Kelly Extra Heavy Forceps303
 Kelly Hemostatic Forceps41,201
 Kelly Hemostatic Forceps Sklarlite™41,470
 Kelly Placenta Forceps58,373
 Kelly Retractor109



Kelly Scissors Curved.....	306
Kelman Air Cystotome.....	173
Kelman-Mcpherson Tying Forceps.....	160,489
Keratome Berens.....	134
Keratome Castroviejo.....	134
Keratome Grieshaber Type.....	134
Keratome Jaeger.....	134
Kern Bone Holding Forceps.....	237,238,282
Kerrison Rongeur.....	194
Kevorkian Biopsy Punch.....	339
Kevorkian-Younger Biopsy Punch.....	340
Kevorkian-Younger Endocervical Curette.....	321
Key Elevator.....	245
Keyes Biopsy Punch.....	317
Keyes Cutaneous Punch.....	495
Keyes Dermal Punch Set.....	495
Keyes Finger Ring Cutter.....	496
Keyes Vulvar/Dermal Punch.....	317
Kidney Basin.....	508
Kidney Clamp Herrick.....	50
Kidney Clamp Mayo-Guyon.....	51,127
Kidney Clamp Stille.....	51,127
Kidney Stone Forceps Randall.....	127
Kieland Obstetrical Forceps.....	370
Kieland-Luikart Obstetrical Forceps.....	370
Killian Nasal Speculum.....	185
King Forceps.....	74,290
King Wound Forceps.....	283
Kirby Iris Forceps.....	156
Kirby Muscle Hook & Lens Expressor.....	132
Kirk Bone Mallet.....	232,278
Kirmission Periosteal Raspatory.....	244
Kirschner Bone Drill.....	253
Kirschner Bow.....	254
Kirschner Retractor.....	225
Kirschner Wire.....	255,286
Kleinert-Kutz Rongeur.....	215
Knapp Eye Speculum.....	129
Knapp Iris Scissors.....	149
Knapp Lens Spoon.....	139
Knee Retractor Blount.....	242

KNIVES

Knife, Abraham Tonsil.....	199
Knife, Amputating Liston.....	250
Knife, Arthroscopic Hook.....	457
Knife, Atkins Tonsil.....	199
Knife, Banana - Arthroscopy.....	457
Knife, Barkan Goniotomy.....	136
Knife, Cartilage Lowe-Breck.....	249
Knife, Chisel.....	269
Knife, Corn Extra Heavy.....	269

Knife, Dean Tonsil.....	199
Knife, Disposable Miniature Ear.....	183,209
Knife, Downing Cartilage.....	248
Knife, Fisher Tonsil.....	199
Knife, Freer Septum.....	188
Knife, Gerzog (Sexton) Ear.....	181
Knife, Gill Corneal.....	136
Knife, Golf Stick.....	270
Knife, Graefe Cataract.....	134
Knife, Humby Skin Graft. Potter Bodenhe.....	496
Knife, Joseph.....	193
Knife, Miniature Ear Disposable.....	528
Knife, Murphy Plaster.....	256,291
Knife, Needle Von Graefe.....	134
Knife, Nucleus.....	268
Knife, Plaster Reiner.....	258
Knife, Politzer Ear.....	181
Knife, Retrograde.....	457
Knife, Ridlon Plaster.....	256
Knife, Rosette.....	457
Knife, Sklar Diamond Blade Micrometer.....	172
Knife, Sklar Diamond Titanium Phanco.....	171
Knife, Sklar Diamond Titanium Step.....	171
Knife, Smilie.....	457
Knife, Smillie Meniscus.....	248
Knife, Soft Corn.....	268
Knife, Swivel Ballenger.....	189
Knife, Tonsil Canfield.....	199
Knife, Tonsil Douglass.....	199
Knife, Tonsil Lothrop.....	199
Knife, Tooke Corneal.....	136
Knife, Traditional.....	457
Knife, Tyding Tonsil.....	199
Knife, Wheeler Discission.....	134
Knife, Ziegler.....	136
Knight Dressing Forceps.....	186
Knight Nasal Scissors.....	21,190
Knight Septum Forceps.....	186
Knot Guide - Endoscopy.....	445
Knot Tightener Harris Wire.....	253
Knowles Bandage Scissors.....	27
Kogan Endospeculum Laser.....	362
Kogan Endospeculum Sklar Blue™.....	352
Kogan Endocervical Speculum.....	313
Kraff-Ultrata Capsulorhexis Forceps.....	162
Kratz-Barraquer Wire Eye Speculum.....	128
Krause Ear Snare.....	181
Krause Nasal Snare.....	188
Kuglen Iris Hook & Lens Manipulator.....	142
Kuhnt Fixation Forceps.....	157
Kyle Applicator.....	184

L

La Force Adenotome.....	203
La Grange Scissors.....	22
Lachrymal Dilator Bowman.....	144
Lachrymal Dilator Castroveijo.....	144
Lachrymal Dilator Infant.....	144
Lachrymal Dilator Muldoon.....	144
Lachrymal Dilator Ruedemann.....	144
Lachrymal Dilator Wilder.....	144
Lachrymal Dilator Williams.....	144
Lachrymal Dilator Ziegler.....	144
Lacrimal Meller Sac Retractor.....	491
Lacrimal Wilder Sac Retractor.....	133
Laforce Foreign Body Spud.....	135
Lagenbeck Bone Holding Forceps.....	239
Lagenbeck Bone Saw.....	282
Lahey Forceps.....	45,48
Lahey Gall Duct Forceps.....	123
Lahey Metzenbaum Scissors.....	10
Lahey Retractor.....	107,111,205,390
Lahey Traction Forceps.....	65,334,383
Lambert Chalazion Forceps.....	165,166
Lambotte Bone Holding Forceps.....	237
Lambotte Osteotome.....	194,227,228,279
Lamina Gouge.....	230
Lamina Gouge Capener.....	230
Lamina Spreader.....	240
Laminectomy Rongeur Schlesinger Cerv.....	220
Laminectomy Rongeur Smith-Peterson.....	213
Lancaster Eye Speculum.....	130
Lane Bone Holding Forceps.....	237
Lane Elevator.....	246
Lane Tissue Forceps.....	72
Langenbeck Elevator.....	245,270
Langenbeck Metacarpal Saw.....	250
Langenbeck Retractor.....	107,390
Laparotomy Ring.....	334
Larry Probe.....	121,298
Larsen Tendon Forceps.....	248
Laryngeal Mirror.....	206

LASER INSTRUMENTS

Laser Adson Tissue Forceps.....	367
Laser Allis Forceps.....	299,367
Laser Auvard Vaginal Speculum.....	361
Laser Babcock Forceps.....	299,366
Laser Backhaus Towel Clamp.....	368
Laser Backstops.....	365
Laser Bozeman Forceps.....	366
Laser Champion Cervical Hook.....	364
Laser Champion Grasping Forceps.....	366

Laser Cervical Hook	364	Lempert Rongeur	215,276	Littauer Nasal Forceps.....	187
Laser Clemetson Forceps.....	368	Lens Aker Pusher	142	Locke Elevator	268
Laser Collin Vaginal Speculum	361	Lens Azar Manipulating Hook.....	141	Locke Phalangeal Forceps	240,285
Laser Depth And Width Rulers	365	Lens Daviel Spoon.....	139	Long Forceps.....	328
Laser Depth Ruler.....	365	Lens Expressor & Kirby Muscle Hook	132	Loop Lens Gills/Welsh	139
Laser Dressing Forceps.....	299	Lens Expressor & Rizzuti Iris Retractor	132	Loop Lewis Lens.....	139
Laser Emmett Hook	363	Lens Expressor Arruga	132	Loop New Orleans Lens	139
Laser Freeway Graves Vaginal Spec.	360	Lens Harris-Sinskey Manipulating Hook.....	142	Loop Simcoe Nucleus.....	139
Laser Graves Tenaculum Forceps	366	Lens Insertion Hook Tennant Anchor	142	Loop Wilder Lens.....	139
Laser Graves Vaginal Speculum	358,360	Lens Jaffe Manipulating Hook	142	Lordon Chalazion Forceps.....	166
Laser Graves Wide View Vaginal Spec.	360	Lens Lester Manipulator	142	Lorna (Edna) Towel Clamp.....	87,207
Laser Heaney Needle Holder	368	Lens Lewis Loop.....	139	Lothrop Tonsil Knife.....	199
Laser Iris Hook.....	363	Lens Loop Gills/Welsh	139	Lothrop Uvula Retractor.....	204
Laser Jackson Retractor.....	368	Lens Loop New Orleans	139	Lounsbury Placenta Curette	321
Laser Kogan Endospeculum.....	362	Lens Manipulator & Kuglen Iris Hook	142	Love-Kerrison-Schlesinger Rongeur.....	219
Laser Lateral Vaginal Speculum	361	Lens Manipulator Lester	142	Love Uvula Retractor	204
Laser Laufe Uterine Polyp Forceps	368	Lens Sinskey Manipulating Hook.....	142	Lovelace Gall Bladder Traction Forceps.....	126
Laser Marlow Black Anal Speculum	299	Lens Spoon Knapp	139	Lovelace Grasping Forceps.....	384
Laser Maxi Iris Hook.....	363	Lens Wilder Loop.....	139	Lowe-Breck Cartilage Knife	248
Laser Mini Emmett Hook	363	Leriche Forceps	376	Lower Gall Duct Forceps	50,123
Laser Newport Cervical Manip. Hook	364	Lester Conjunctival Forceps	78,157	Lowman Clamp	236,282
Laser Offset Hook.....	364	Lester Lens Manipulator	142	Lube For Instruments	
Laser Pederson Vaginal Spec.	358,359,360	Lewicki Hook.....	141	(Sklar Lube™).....	510,514,521,525
Laser Rochester-Pean Forceps.....	367	Lewin Bone Forceps	239,285	Lucae Bayonet Forceps.....	76,180
Laser Schroeder Tenaculum Forceps	366	Lewis Lens Loop.....	139	Lucae Mallet	232,278
Laser Schweizer Forceps	368	Lewis Rasp	195,233,273	Luer Bone Rongeur	216
Laser Smoke Evacuation Tube.....	361	Lexer Mini Chisel	230	Luethy Beck Needle Holder T-C	98
Laser Smoke Evacuation Tube Holder	361	Lexer Mini Gouge	230	Luethy-Beck Needle Holder.....	325
Laser Steiner-Auvard Vaginal Speculum....	361	Lid Forceps Erhardt	165	Luikart Obstetrical Forceps.....	370
Laser Surgery Forceps	299	Lid Plate Jaeger.....	132	Luikart-Bill Traction Handle.....	372
Laser Tenaculum Hooks.....	365	Lid Retractor Desmarres.....	107,132,166	Lung Grasping Forceps Collin/Duval	126
Laser Tuttle/Singley Forceps	367	Ligamentum Flavum Forceps Preston.....	248	Lung Retractor Zalkind	108,389
Laser Wand Clamp	360	Ligator McGivney Hemorrhoidal	294		
Laser Width Ruler	365	Ligator Rudd Clinic Hemorrhoidal.....	293		
Lateral Laser Vaginal Speculum.....	361	Ligature Carrier Cooley	426		
Lateral Retractor Young.....	107	Ligature Carrier DeBakey-Semb.....	412		
Lateral Sklar Blue™ McGee Vaginal Retr. ..	350	Ligature Forceps And DeBakey Diss.....	410		
Lateral Sklar Blue™ Vaginal Retractor	350	Ligature Needle	283		
Lateral Vaginal Retractor	309	Ligature Nelson Needle	391		
Laufe Divergent Outlet Obstetrical Fcps.....	372	Link Rasp.....	233		
Laufe Laser Uterine Polyp Forceps	368	Liquid Sklar Kleen.....	513,524		
Laufe Uterine Polyp Forceps	54,328	Lister Bandage Scissors	26		
Laufe Uterine Polyp Forceps Sklar Blue™ ..	357	Lister Bandage Scissors Sklarlite™	26,467		
Laufe-Barton-Kieland Forceps.....	369	Liston Amputating Knife.....	250		
Laufe-Piper Obstetrical Forceps	369	Liston Bone Forceps.....	211,212,274,275		
Lawrence Forceps	379	Litegrip™ Sklar Adson Forceps.....	68		
Lawton Forceps	329	Litegrip™ Sklar Adson-Brown Forceps.....	68		
Lebsche Sternum Chisel.....	388	Litegrip™ Sklar Iris Forceps	68,156		
Lees Bronchus Clamp	420	Littauer Cilia Forceps.....	82,163		
Leff Stethoscope For Fetal Heart.....	500	Littauer Cutting Forceps	260,261		
Leksell Rongeur.....	213	Littauer Cutting Forceps (Titanium Nitride).....	261		
Lemmon Intima Dissectors	432	Littauer Cutting Forceps Sklar-Angular.....	261		
Lemmon Sternal Approximator	387	Littauer Cutting Forceps Sklar-Taper.....	261		
Lemmon Vascular Needle Holder.....	395	Littauer Ear Forceps	178		

M

Magill Catheter Forceps.....	65
Magnatone Stethoscope.....	500
Magnetic Junior Probe & For. Body Loop....	135
Magnifier Otoscope Bruening	176
Magnifier With Plain Splinter Forceps.....	81
Malleable Simpson Uterine Sound	317
Mallet Gerzog	232,278
Mallet Kirk	232,278
Mallet Lucae	232,278
Mallet Rush (Crane).....	278
Mallet Sklar	232
Mallet Sklar (Mead).....	278
Mallet Steel Bone.....	232
Mallet With Two Plastic Ends	232,278
Maltz Rasp	233,273
Maltz Rasp T-C.....	273
Manhattan Eye & Ear Suturing Fcps	159,161
Manipulating Hook Azar Lens.....	141



Manipulating Hook Harris-Sinsky Lens.....142	McGee Sklar Blue™ Lateral Vag. Retr.....350	Micro Iris Hook Sinsky141
Manipulating Hook Jaffe Lens142	McGivney Hemorrhoidal Ligator294	Micro Iris Scissors.....149,484
Manipulating Hook Sinsky142	McGuire Corneal Scissors146	Micro McPherson Iris Suturing Forceps.....159
Manipulation Cerv. Hook Laser Newport.....364	McIndoe Bone Cutting Forceps191,276	Micro Mosquito Forceps47
Manipulator Blue Sklar Cervical.....355	McKinney Eye Speculum.....128	Micro Needle Holder479
Manipulator Newport Cervical.....315	McLane-Tucker Obstetrical Forceps.....371	Micro Needle Holder Jacobson.....91
Manipulator Sklar Cervical.....113	McLane-Tucker-Kieland Ob. Forceps.....371	Micro Rhoton Forceps487
Marc Grasping Forceps441	McLane-Tucker-Luikart Ob. Forceps370	Micro Surgery Needle Holder491,492
Marcuse Tubing Forceps86	McNeil-Goldman Fixation Rings131	Micro Surgery Scissors.....480,481,486
Marker Sklar Scribe™ For Skin497,529	McPherson Eye Speculum129	Micro Suture Tying Forceps.....83
Marlow Laser Anal Speculum299	McPherson Micro Iris Suturing Forceps.....159	Micro Suturing Forceps Bonn159
Martin Pelvimeter.....374	McPherson Tying Forceps159	Micro Tray Double Deck507
Martini Scissors19	McPherson-Vannas Scissors.....31,151,484	Micro-Cut Eppendorfer Biopsy Punch341
Martini Bone Curette.....236	McReynolds Spatula And Hook.....138	Micro-Cut Kevork.-Younge Biopsy Punch ...340
Maryland Dissector437,441,443,444	Mead Rongeur218,277	Micro-Cut Mini Tischler Delicate Punch.....336
Mastoid Chisel Alexander229	Measured Sklar Dose Delivery Syringe316	Micro-Cut Sklar Kevorkian Biopsy Punch339
Mastoid Gouge Alexander229	Medicine Cup.....508	Micro-Cut Sklar Oval Biopsy Punch.....338
Mathieu Needle Holder90,325	Meller Lacrimal Sac Retractor491	Micro-Cut Sklar Tisch. Oval Biopsy Punch..337
Mathieu Needle Holder T-C98	Meller Retractor133	Micro-Cut Sklarhone™ Iris Scissors37
Mathieu Raspatories.....244	Mellinger Speculum129	Micro-Cut Sklarhone™ Mayo Scissors37
Mathieu Retractor105	Membrane Forceps Iowa59,373	Micro-Cut Sklarhone™ Metzen. Scissors37
Matson Rib Stripper387	Meniscus Clamp Sklar247	Micro-Cut Sklarhone™ Operating Scissors...36
Maumenee Colibri Corneal Forceps.....158,488	Meniscus Hook Smille Retractor.....243	Micro-Cut Tischler Cervical Biopsy Punch..335
Maxi Iris Hook Laser.....363	Meniscus Knife Smillie.....248	Micro-Cut Universal Style Biopsy Instr.343
Maxi Iris Hook Quick Release.....314	Meniscutome457	Micro-Cut Wittner Uterine Biopsy Punch342
Maxi Iris Hook Sklar Blue™.....354	Metacarpal Bone Saw Charriere.....249	Micro-Grip™ Micro. Forceps Sklar482,483
Mayo Abdominal Retractor114	Metacarpal Saw Langenbeck250	Microcoron. Bulldog Clamp Diethrich75,416
Mayo Common Duct Probe125	Metal Ruler498	Microcut Sklarhone™ Scissors.....36
Mayo Common Duct Spoon.....125	Metzenbaum Diss. Scissors11,190,322,431	Micrometer Diamond Blades172
Mayo Dissecting Scissors.....9,305,323,392	Metzenbaum Diss. Scis. Sklar Edge™ T-C...35	Microsurgery Instruments475
Mayo Dissecting Scis. Sklar Edge™ T-C34	Metzenbaum Lahey Scissors.....10,190	Microsurgery Forceps478
Mayo Dissecting Scissors Sklarcut™33	Metzen. Lahey Scis. Sklarcut™33,465,468	Microsurgery Needle Holders479
Mayo Diss. Scis. Sklarlite™9,33,305,464	Metzenbaum Nelson Scissors305	Microsurgery Scissors480,481
Mayo Gallstone Scoop.....125	Metzenbaum Scissors440,443	Miller Scissors.....19,30,298
Mayo Scissors Micro-Cut Sklarhone™37	Metzenbaum Scis. Micro-Cut Sklarhone™...37	Miller-Senn Retractor.....105,196
Mayo Tray.....508	Meyerding Retractor108,113,225,389	Mini Blumenthal Forceps276
Mayo-Adams Retractor.....101	Meyerding Skid241	Mini Dilator/OS Finder Set Sklar.....317
Mayo-Blake Gallstone Forceps.....49	Meyerding Skin Hook And Retractor106	Mini Emmett Hook Laser363
Mayo-Collins Forceps.....110	Meyhoefer Chalazion Curette141	Mini Emmett Hook Quick Release314
Mayo-Guyon Kidney Clamp.....51,127	Mi-Mark™ Endomet. And Endocerv. Pack .345	Mini Emmett Hook Sklar Blue™354
Mayo-Hegar Needle Holder89,324	Mi-Mark™ Endometrial Biopsy Set.....344	Mini Gouge Lexer230
Mayo-Hegar Needle Holder T-C93,95,99	Mi-Mark™ Endocervical Helix Currette.....345	Mini Hohmann Bone Elevator242,280
Mayo-Noble Dissecting Scissors12,305	Michel Applying And Removing Fcps183,19	Mini Lexer Chisel230
Mayo-Noble-Stille Dissecting Scissors12	Michel Tissue Forceps.....72	Mini Sklar Endocervical Curette.....320
Mayo-Robson Forceps48	Michel Tru-Clips.....119	Mini Tischler Micro-Cut Delicate Punch.....336
Mayo-Stille Diss Scis. Sklar Edge™ T-C.....34	Microsurgery Instruments475-492	Miniature Disposable Ear Knives...183,209,528
Mayo-Stille Dissecting Scissors.....12,305,323	Micro Adson Forceps.....69	Miniature Ear Knife Disposable209
McBurney Retractor.....106	Micro Alligator Ear Forceps178,180	Miniature Edge Blades.....210
McClure Spring Handle Scissors31,152,486	Micro Bellucci Ear Scissors180	Miniature Edged Blades W/Handles Scal. ...209
McCullough Utility Forceps79,161	Micro Bonn Suturing Forceps489	Miniature Subramanian Aorta Clamp.....419
McGannon Iris Retractor.....140	Micro Forceps478	Mirror Laryngeal.....206
McGee Lateral Vaginal Retractor309	Micro Forceps Jacobson.....74	Mirror Head.....498

Mixer Dissector	441,444
Mixer Forceps	46,124,303,471
Mixer Gall Duct Forceps	124
Mixer Scissors	19
Mogen Circumcision Clamp	303
Moleskin Scissors	28,292
Moore Drill	253
More Bone Skid	243
Mosquito Delicate-Long Forceps	375
Mosquito Forceps DeBakey Halsted	409
Mosquito Forceps Halsted	38
Mosquito Forceps Halsted Sklarlite™	39,469
Mosquito Forceps Hartmann Delicate	42,469
Mosquito Forceps Jacobson Delicate	47
Mosquito Forceps Johns Hopkins	45
Mosquito Forceps Micro	47
Mosquito Forceps Thompson	45
Mouth And Throat Instruments	197-206
Mouth Gag Doyen-Jansen	197
Mouth Gag Jennings	197
Mouth Gag Wesson	197
Moynihan Forceps	50
Moynihan Gall Duct Forceps	123
Moynihan Probe And Scoop	125
Muldoon Lachrymal Dilator	144
Multi-Cut Utility Scissors	28,259
Multi-Purpose Cooley Clamps	421
Murdock Eye Speculum	128
Murless Head Extractor	372
Murphy-Lane Bone Skid	241
Murphy Plaster Knife	256,291
Muscle Clamp Berens	164
Muscle Graefe Hook	140
Muscle Hook Culler Rectus	140
Muscle Hook Jameson	140
Muscle Kirby Hook & Lens Expressor	132
Myoma Drill	451
Myringotome Buck	181

N

N-I Automatic Tourniquet	255,287
Nail And Bone Rasp	234,271,272
Nail And Cuticle Nipper	264
Nail And Cuticle Scissors	29
Nail Forceps Platypus	265
Nail Instrument Ingrown	267
Nail Nippers	262
Nail Splitter	268
Nail Splitting Scissors Ingrown	29,265
Nasal Bone Saw Joseph	192

Nasal Chisel Cottle	194
Nasal Chisel Fomon	194
Nasal Forceps Hartmann	186
Nasal Forceps Jansen	76,187
Nasal Forceps Kazanjian	191
Nasal Forceps Littauer	187
Nasal Forceps Wilde	187
Nasal Gerzog Speculum	186
Nasal Instruments	185-206
Nasal Killian Speculum	185
Nasal Knight Scissors	190
Nasal Plastic Instruments	188,190
Nasal Rasp Lewis	195
Nasal Saw Bosworth	192
Nasal Scissors Cottle	21,191
Nasal Scissors Knight	21
Nasal Snare Krause	188
Nasal Speculum Halle	185
Nasal Speculum Vienna	185
Needle And Spoon Fisher	138
Needle And Spud Dix	135
Needle Cooper Director And Aneurism	122
Needle Deschamp	120,283
Needle For Injection & Irrigation	449

NEEDLE HOLDERS

Needle Holders	88-99
Needle Holder, Anastomosis T-C	325
Needle Holder, Barraquer	91,168,492
Needle Holder, Baumgartner	88,93
Needle Holder, Boynton	169
Needle Holder, Bozeman-Heaney T-C	98,325
Needle Holder, Brown	88
Needle Holder, Castroviejo	91,491
Needle Holder, Castroviejo-Kalt	90,168
Needle Holder, Cohan	169,491
Needle Holder, Collier	89
Needle Holder, Crile-Murray	88,92
Needle Holder, Crile-Wood	89,324
Needle Holder, Derf	88,92
Needle Holder, Endoscopy	445
Needle Holder, Finochietto	90,324
Needle Holder, Halsey	88,93
Needle Holder, Heaney	90,325
Needle Holder, Jacobson Micro	91
Needle Holder, Johnson	90
Needle Holder, Kalt	168
Needle Holder, Lemmon Vascular	395
Needle Holder, Mathieu	90,325
Needle Holder, Mayo-Hegar	89,93,324
Needle Holder, Mayo-Hegar Laser	368
Needle Holder, Micro	479,491,492

Needle Holder, Neivert	169,176,492
Needle Holder, New Orleans	89
Needle Holder, Olsen-Hegar	89,169,324
Needle Holder, Sarot	89
Needle Holder, Sklargrip™ T-C DeBakey	93
Needle Holder, Sklargrip™ T-C Heaney	93
Needle Holder, Sklargrip™ T-C Sarot	93
Needle Holder, Sklargrip™ T-C Wangenst.	93
Needle Holder, Stangel-Barraquer	91
Needle Holder, Stevens	90,169,492
Needle Holder, Stratte	324
Needle Holder, Troutman	168,492
Needle Holder, Webster	88,324
Needle Holder, T-C Alligator Action	98
Needle Holder, T-C Baumgartner	95
Needle Holder, T-C Castroviejo	97
Needle Holder, T-C Crile-Murray	94
Needle Holder, T-C Crile-Wood	95
Needle Holder, T-C Derf	94
Needle Holder, T-C Finochietto	96
Needle Holder, T-C Halsey	95
Needle Holder, T-C Heaney	96
Needle Holder, T-C Insert Ryder	99
Needle Holder, T-C Jacobson	97
Needle Holder, T-C Luethy Beck	98,325
Needle Holder, T-C Mathieu	98
Needle Holder, T-C Mayo-Hegar	95,99
Needle Holder, T-C New Orleans	95
Needle Holder, T-C Olsen-Hegar	96
Needle Holder, T-C Ryder	95
Needle Holder, T-C Sarot	96
Needle Holder, T-C Stratte	96
Needle Holder, T-C Webster	94
Needle Knife Von Graefe	134
Needle Ligature	283
Needle Nelson Ligature	391
Needle Nose Grasping Forceps	437
Needle Nose Pliers	252,287
Needle Veress - Endoscopy	450
Needles Body Foreign	137
Negus Hemostatic Forceps	379
Neivert Needle Holder	169,176,492
Nelson (Gosset) Retractor	102,386
Nelson Ligature Needle	391
Nelson Trocar	118
Neonatal Castaneda Clamp	427
Neonatal Cooley Vascular Clamp	426
Nerve And Vessel Retractor	433
Neuro Sklar Retractor	225
Neurological Rabiner Hammer	497
Neurological Wartenberg Pinwheel	497
New Orleans Lens Loop	139



New Orleans Needle Holder	89,95
Newport Cervical Manipulator.....	315
Newport Laser Cervical Manip. Hook	364
News Hook	111
News Tracheal Hook	205
Nipper Cuticle And Nail.....	264
Nipper Nail	262,263
Nipper Tissue.....	264
Non-Slip Sklar Tissue Forceps	74
Non-Traumatic Allis Forceps	284
Novak Endometrial Curette.....	319
Noyes Alligator Forceps.....	187
Noyes Iridectomy Scissors	149,485
Nucleus Forceps Simcoe.....	158
Nucleus Knife.....	268
Nucleus Loop Simcoe.....	139
Nucleus Rotator Bechert.....	143
Nucleus Simcoe Delivery Cannula	173
Nugent Iris Hook.....	140
Nugent Superior Rectus Forceps	164
Nugent Utility Forceps	161
Nurse's Stethoscope Lightweight	499

O

O'Brien-Elschnig Forceps	157,488
O'Conner Flat Tenotomy Hook	140
O'Conner O'Sullivan Retractor	311
O'Connor Hook.....	140
O'Connor Iris Forceps.....	156,488
O'Hanlon Intestinal Clamp	48
O'Sullivan O'Conner Retractor	311
O'Sullivan-O'Connor Abdominal Retractor ..	103

OBSTETRICAL FORCEPS

Obstetrical Forceps And Instruments ...	369-374
Obstetrical Forceps Barton	369
Obstetrical Forceps De Lee	371
Obstetrical Forceps Dewey	372
Obstetrical Forceps Elliot	369
Obstetrical Forceps for Gyn. Biopsy	338
Obstetrical Forceps Kieland-Luikart.....	370
Obstetrical Forceps Laufe-Piper	369
Obstetrical Forceps Luikart.....	370
Obstetrical Forceps McLane-Tucker.....	371
Ob. Fcps McLane-Tucker-Kieland	371
Ob. Fcps McLane-Tucker-Luikart	370
Obstetrical Forceps Piper	369
Obstetrical Forceps Simpson-Luikart.....	370
Obstetrical Hale Forceps	371

Obstetrical Kieland Forceps.....	370
Obstetrical Laufe Diver. Forceps Outlet.....	372
Obstetrical Simpson Forceps.....	371
Obstetrical Stethoscope Delee-Hillis	500
Obturator With Cutter P.I. Plug	243,288
Occluding Tube Clamp	86
Occlusion Clamp Cooley Cava	422
Occlusion DeBakey Tangential.....	404
Ochsner Trocar	118
Ockerblad Forceps	51
Offset Laser Hook	364
Offset Sklar Blue™ Hook.....	355
Ohl Elevator	246,270
Olivecrona Rongeur.....	216
Olsen-Hegar Needle Holder	89,96,169,324
Operating Scissors	6,7,322,440,462
Operating Scissors Sklarcut™	33
Operating Scissors Sklarhone™.....	36
Operating Scissors Sklarlite™	6,33,468
Operating Scissors T-C Sklar Edge™	34
Operating Spoon With Retaining Spoon.....	440
Oral Screw Plastic	197
Orthopedic Instruments	211-259
OS Finder Set Sklar Mini-Dilator.....	317
Oscillating Plaster Saw	256,291
Osteotome Army Pattern	226
Osteotome Capener	230
Osteotome Cinelli	193
Osteotome Hibbs	228,230
Osteotome Hoke.....	228,278
Osteotome Jr. Lambotte	279
Osteotome Lambotte	194,227,228,279
Osteotome Sheehan.....	229
Osteotome Silver	193,229
Osteotome Sklar.....	229
Osteotome Smith Peterson.....	226
Osteotome Stille Type	227
Otis Bougie A Boule.....	302
Otis/Dittel Urethral Sound.....	302
Otoscope Bruening Magnifier	176
Outlet Ob. Forceps Laufe Divergent.....	372
Oval Biopsy Punch Micro-Cut Sklar.....	338
Oval Biopsy Punch Sklar Tischler.....	337
Oval Biopsy Punch Sklar Tisch. Wide Bite ..	337
Oval Biopsy Punch Sklar Wide Bite.....	338
Oval Sklar Biopsy Punch	338
Overholt Forceps	53,381
Overholt-Geissendoerfer Forceps	381
Ovum Forceps Bierer.....	58,373
Ovum Forceps Corey.....	58,373

P

P.I. Plug Cutter With Obturator	243,288
Pacific Grasper - Arthroscopy.....	460
Packer And Excavator	267
Packer And Probe.....	266
Packer And Spatula	266
Packer Bone Dissector	231
Pans & Covers for Instrument Sterilizing....	507
Parham-Martin Bone Clamp	240
Park-Guyton Speculum.....	130
Park-Maumenee Eye Speculum	130
Parker Retractor	110
Passer Tendon With Eye	249
Patent Ductus Forceps Cooley	422
Paul Retractor.....	107
Payr Pylorus Clamp	52
Pean Intestinal Clamp.....	48
Pean Laser Rochester Forceps	367
Peanut Sponge Forceps	86,504
Pederson Vaginal Speculum	308,358,359
Pederson Sklar Blue™ Vaginal Spec. ...	347,348
Pediatric Cast Breaker Mason	258
Pediatric Forceps DeBakey	418
Pedicle Clamp Wertheim-Cullen.....	52,127
Peet Splinter Forceps	494
Pelvimeter Collyer.....	374
Pelvimeter Delee Internal	374
Pelvimeter Martin.....	374
Pemberton Anastomosis Clamp	50
Penis Clamp Stockman (Zipser)	303
Penner Forceps	248
Pennington Grasping Forceps.....	383,441,444
Percussion Taylor Hammer	497
Perell Fetoscope.....	500
Perforator Williams Bayonet	181
Periosteal Elevator Joseph	189
Periosteal Elevator Sedillot.....	246
Periosteal Kirrmission Raspatory	244
Periosteotome Costal Alexander	244
Peripheral Vascular Clamp DeBakey	397
Periph. Vessel Fcps DeBak. Atraum. ...	397,400
Peritoneal Scissors	439
Perthes Bone Awl	254
Phalangeal Forceps Locke	240,285
Phanco Knife Sklar Diamond Titanium	171
Phaneuf Forceps	328,330
Physician's Stethoscope	499
Physicians Splinter Forceps	494
Piffard Curette.....	281,496
Pillar Retractor And Hurd Tonsil Dissector ..	200
Pin And Wire Extractor T-C Ring Handle....	288

Pin Cutter Sklar.....251,289
 Pin Cutter T-C.....251,289
 Pin Diamond Cutter289
 Pin Snap Lock/Wire Extractor.....289
 Pin Steinmann255
 Pinard Stethoscope For Fetal Heart499
 Pins Steinmann.....286
 Pinwheel Wartenberg Neurological497
 Piper Obstetrical Forceps369
 Placenta Curette Lounsbury321
 Placenta Forceps Barrett58,374
 Placenta Forceps Bond58,374
 Placenta Forceps Javerts58,373
 Placenta Forceps Kelly58,373
 Plain Splinter Forceps With Magnifier.....81,493
 Plain Wire Speculum129

PLASTER INSTRUMENTS

Plaster Cast Instruments291
 Plaster Cast Breaker Wolfe-Boehler.....291
 Plaster Forceps Van Buren.....258
 Plaster Knife Murphy256,291
 Plaster Knife Reiner.....258
 Plaster Knife Ridlon256
 Plaster Saw Engel256
 Plaster Saw Oscillating256,291
 Plaster Saw Wigmore256
 Plaster Shears Seutin257,292
 Plaster Shears Stille258
 Plaster Spreader Beeson.....259
 Plaster Spreader Hennig259
 Plaster Spreader Walton.....259,291
 Plastic Surgery Retractor.....111
 Plastic Surgery Scissors13
 Plate And Bone Holding Forceps.....239
 Platt Tendon Transplantation Forceps.....247
 Platypus Nail Forceps.....265
 Pliers Needle Nose252,287
 Pliers Square End.....252,287
 Pliers T-C Double Action Wire Extraction ...288
 Plug Cutter P.I. With Obturator243,288
 PNA Forceps274
 Podi-Bone Rasp.....271
 Podiatry Instruments.....260-292
 Podiatry/Shears292
 Polish for Surgical Instruments
 (Sklar Polish™).....514,521,525
 Politzer Ear Knife181
 Polyp Forceps Laufe Uterine54,328
 Polyp Forceps Uterine Sklar Blue™ Laufe ..357
 Polyp Laufe Uterine Forceps Laser368
 Pomeroy Ear Syringe All Metal.....182

Poole Suction Tube117
 Potter Bodenham Humby Skin Graft. Knife.496
 Potts-Smith Forceps74,356,367,391,394
 Potts-Smith Scissors.....30,429
 Potts-Smith T-C Dressing Forceps85
 Powder Sklar Kleen Instr. Deterg.520,524
 Pratt Crypt Hook298
 Pratt Forceps64
 Pratt Rectal Speculum.....296
 Pratt T-Shaped Clamp.....124,303
 Pratt Uterine Dilator318
 Precision Scissors Sklar25
 Preston Ligamentum Flavum Forceps.....248
 Prince Advancement Forceps.....79,164
 Prince Trachoma Forceps166

PROBES

Probe And Directors121-122
 Probe And Packer.....266
 Probe And Scoop Moynihan125
 Probe And Spatula.....266,267
 Probe Barr Fistula.....122,298
 Probe Bullet And Rectal.....122
 Probe Common Duct Mayo125
 Probe Double Ended121
 Probe Esmarch Tin Bullet122
 Probe Graduated449
 Probe Hook Graduated.....457
 Probe Junior Magnetic & For. Body Loop...135
 Probe Larry.....121,298
 Probe Spear Point121
 Probe Tendon Pass. W/Eye And Groove ...249
 Probe With Eye.....121
 Procedure Plastic Tray508
 Proctoscope Hirschman Type.....300
 Prostatic Retractor Young.....304
 Protectors, Sklarguard Tip.....502,503
 Proctoscope Hirschman Type.....530
 Providence Hospital Forceps.....45
 Pryer-Pean Vaginal Retractor.....312
 Pryor-Pean Retractor114
 Ptosis Forceps Berke.....165
 Puller Wire T-C252
 Punch Action Hartmann Forceps.....178

PUNCH BIOPSY

Punch Biopsy, Cervical Tischler335
 Punch Biopsy, Eppendorfer341
 Punch Biopsy, Forceps Cut-Thru Type.....438
 Punch Biopsy, Gaylor343
 Punch Biopsy, Gelhorn343
 Punch Biopsy, Kevorkian Sklar.....339

Punch Biopsy, Kevorkian-Young340
 Punch Biopsy, Keyes.....317
 Punch Biopsy, Mini-Tischler Delicate336
 Punch Biopsy, Mini Tischler Wide Bite336
 Punch Biopsy, Micro-Cut Eppendorfer341
 Punch Biopsy, Micro-Cut Kevork-Young ..340
 Punch Biopsy, Micro-Cut Sklar338
 Punch Biopsy, Micro-Cut Sklar Kevorkian ..339
 Punch Biopsy, Micro-Cut Tischler.....335
 Punch Biopsy, Micro-Cut Sklar Tisch. Oval 337
 Punch Biopsy, Micro-Cut Wittner Uterine ..342
 Punch Biopsy, Oval Wide Bite Sklar Tisch. 337
 Punch Biopsy, Schubert-Van Doren343
 Punch Biopsy, Sklar Oval338
 Punch Biopsy, Sklar Wide Bite Oval.....338
 Punch Biopsy, Tischler Oval337
 Punch Biopsy, Wittner Uterine.....342
 Punch Keyes Cutaneous495
 Punch Set Keyes Dermal.....495
 Punch Tonsil Hartman (Mosher).....200
 Punch Tonsil Schmeden.....200
 Punch Uterine Biopsy Micro-Cut.....342
 Punch Yeoman Rectal Biopsy297
 Pusher Aker Lens142
 Putti Bone Rasp.....234
 Pylorus Clamp Payr52
 Pylorus Separator Benson.....52

Q

Quick Release Emmett Hook.....314
 Quick Release Iris Hook314
 Quire Foreign Body Instrument.....181

R

Rabiner Neurological Hammer497
 Rack - Saunders Instrument.....505
 Rack - Weinstein Instrument.....505
 Ragnell Diss. Scis. Sklarcut™ Sklarlite™32,467
 Ragnell Dissecting Scissors21
 Ragnell Dissecting Scissors Sklarcut™32
 Ragnell Retractor.....106
 Ralks Hook113
 Randall Endometrial Curette.....319
 Randall Stone Forceps49,127
 Rankin Anastomosis Clamp.....52
 Rankin Forceps Sklar49
 Rankin Hemostatic Forceps.....44
 Rasp And File Fomon233,273



Rasp Aufricht Glabellar.....	195	Retractor, Beckman-Eaton.....	224	Retractor, Little.....	106
Rasp Bone #10.....	272	Retractor, Beckman-Weitlaner.....	224	Retractor, Lothrop Uvula.....	204
Rasp Bone And Nail.....	234,271,272	Retractor, Bennett Tibia.....	242	Retractor, Love Uvula.....	204
Rasp Bone Putti.....	234	Retractor, Blair (Rollet).....	112	Retractor, Mathieu.....	105
Rasp Cottle.....	233,273	Retractor, Blount.....	242	Retractor, Mayo Abdominal.....	114
Rasp Joseph.....	233,273	Retractor, Brantley-Turner.....	114,312	Retractor, Mayo-Adams.....	101
Rasp Lewis.....	195,233,273	Retractor, Brewster.....	108	Retractor, McBurney.....	106
Rasp Link.....	233	Retractor, Cheek Sklar.....	197	Retractor, McGannon Iris.....	140
Rasp Maltz.....	233,273	Retractor, Converse.....	110,196	Retractor, McGee Lateral Vaginal.....	309
Rasp Maltz T-C.....	273	Retractor, Cooley Atrial Valve.....	433	Retractor, Meller.....	133
Rasp Podi-Bone.....	271	Retractor, Crawford Aortic.....	433	Retractor, Meller Lacrimal Sac.....	491
Raspatories Farabeuf.....	244	Retractor, Criile.....	110	Retractor, Meyerding.....	108,113,225,389
Raspatories Mathieu.....	244	Retractor, Cushing Vein.....	106	Retractor, Miller-Senn.....	105,196
Raspatory Alexander.....	387	Retractor, Davidson Scapula.....	116,389	Retractor, Nelson (Gosset).....	102,386
Raspatory Doyen Rib.....	387	Retractor, Deaver Sklargrip™ Handle.....	108	Retractor, Neuro.....	225
Raspatory Kirrmission Periosteal.....	244	Retractor, DeLee.....	114,312	Retractor, O'Sull.-O'Connor Abdom.	103,311
Raspatory Semb.....	387	Retractor, Desmarres Lid.....	107,132,166	Retractor, Parker.....	110
Rectal And Bullet Probe.....	122	Retractor, Doyen.....	114,115,312	Retractor, Paul.....	107
Rectal Biopsy Punch Yeoman.....	297	Retractor, Eastman.....	115	Retractor, Pillar And Tonsil Diss. Hurd.....	200
Rectal Instruments.....	293-300	Retractor, Farabeuf.....	110	Retractor, Plastic Surgery.....	111
Rectal Ives Speculum (Fansler).....	294	Retractor, Fenestrated.....	106,390	Retractor, Pryor-Pean.....	114,312
Rectal Probe Larry.....	298	Retractor, Fomon.....	112,196	Retractor, Ragnell.....	106
Rectal Retractor Barr.....	296	Retractor, For Gall Bladder Extraction.....	452	Retractor, Rib Haight-Finocchio.....	104,386
Rectal Retractor Sawyer.....	296	Retractor, Foss Biliary Duct.....	116	Retractor, Richardson.....	109
Rectal Scissors Miller.....	298	Retractor, Fritch.....	114	Retractor, Richardson-Eastman.....	109
Rectal Speculum Bodenhammer.....	296	Retractor, Gelpi.....	100	Retractor, Rigby.....	100
Rectal Speculum Ives (Fansler).....	293,295	Retractor, Glenoid Fossa.....	243	Retractor, Rizzuti Iris & Lens Expressor.....	132
Rectal Speculum Pratt.....	296	Retractor, Goelet.....	110	Retractor, Roux.....	110
Rectal Speculum Sim.....	296	Retractor, Goldstein.....	101,133,491	Retractor, Sawyer Rectal.....	296
Rectal Weston Snare.....	297	Retractor, (Gosset) Nelson.....	386	Retractor, Self Retaining.....	101,238,196
Rectus Culler Muscle Hook.....	140	Retr., Graether Collar Button Micro-Iris.....	173	Retractor, Self-Retaining Holzenheimer.....	101
Rectus Forceps Tennant-Troutman Super.	164	Retractor, Green.....	106	Retractor, Self-Retaining Jansen.....	101
Rectus Superior Forceps Nugent.....	164	Retractor, Harrington.....	116,389	Retractor, Senn.....	105
Reducing Sleeve - Endoscopy.....	451	Retractor, Hays Finger And Hand.....	241	Retractor, Sims.....	115,311,353
Reiner Plaster Knife.....	258	Retractor, Heaney.....	109	Retractor, Sims-Kelly.....	115,311
Remover B-Clip Stabler - Endoscopy.....	452	Retractor, Hernia.....	105	Retractor, Smille Meniscus Hook.....	243
Remover Foreign Body Bailey.....	135	Retractor, Hibbs.....	116,389	Retractor, Stevenson.....	133
Removing And Applying Forceps Michel.....	119	Retractor, Hupp Tracheal.....	111,205	Retractor, Taylor Spinal.....	243
Renal Artery Clamp.....	425	Retractor, Inge.....	116,240	Retractor, Temple-Fay.....	103
Retractable Tape Measure.....	497	Retractor, Jackson Tracheal.....	111,205	Retractor, Tracheal.....	111,205
		Retractor, Jackson Vaginal.....	311	Retractor, U.S. Army Pattern.....	109
		Retractor, Jackson Vaginal Sklar Blue™ ..	353	Retractor, Vaginal Lateral.....	309
		Retractor, Judd-Masson Bladder And		Retractor, Vaginal Sims.....	311
		Suprapubic.....	304	Retractor, Vessel And Nerve.....	433
		Retractor, Kelly.....	109	Retractor, Volkman.....	105
		Retractor, Kirschner.....	225	Retractor, Weitlaner Self-Retaining.....	100
		Retractor, Knee Blount.....	242	Retractor, Weitlaner-Beckman.....	100
		Retractor, Lahey.....	107,111,205,390	Retractor, Wilder Lacrimal Sac.....	133
		Retractor, Langenbeck.....	107,390	Retractor, Wire Retaining.....	101
		Retractor, Laser Jackson.....	368	Retractor, Young.....	107,304
		Retractor, Lat. Vag. McGee Sklar Blue™ ..	350	Retractor, Zalkind.....	108,389
		Retractor, Lateral Vaginal Sklar Blue™ ..	350	Retriever Tendon Buck-Gramcko.....	248

RETRACTORS

Retractors.....	100-116
Retractor, Adson.....	100
Retractor, Agrikola Sac.....	133
Retractor, Alm Self-Retaining.....	101
Retractor, And Skin Hook Meyerding.....	106
Retractor, Aufranc Cobra.....	241
Retractor, Aufricht.....	109,186
Retractor, Balfour.....	102
Retractor, Barr Rectal.....	296
Retractor, Beckman-Adson.....	224

Retrograde Knife.....	457	Rongeur, Bacon.....	216	Russian Tissue Forceps.....	73
Reynolds Scissors.....	19	Rongeur, Bane.....	216,218	Ryder Needle Holder T-C.....	95,99
Rhoton Micro Suture Forceps.....	487	Rongeur, Beyer Bone.....	215,218		
Rhytidectomy Scissors.....	20	Rongeur, Bone Freidman.....	218		
Rib Contractor Bailey.....	387	Rongeur, Cicherelli.....	216		
Rib Contractor Bailey-Gibbon.....	387	Rongeur, Citelli.....	194		
Rib Raspatory Doyen.....	387	Rongeur, Colcloigh Disc.....	220		
Rib Retractor Haight-Finocchio.....	104	Rongeur, Curved.....	277		
Rib Shears Bethune.....	388	Rongeur, Dale First Rib.....	215		
Rib Shears Collins.....	388	Rongeur, Dean Bone.....	216		
Rib Shears Coryllos.....	388	Rongeur, Echlin.....	212		
Rib Shears Gluck.....	388	Rongeur, Freidman Bone.....	218,277		
Rib Shears Stille.....	388	Rongeur, Frykholm.....	212		
Rib Spreader Burford-Finocchio.....	103,385	Rongeur, Hartmann.....	216		
Rib Spreader Finocchio.....	104,385	Rongeur, Kerrison.....	194		
Rib Spreader Haight-Finocchio.....	386	Rongeur, Kleinert-Kutz.....	215		
Rib Spreader Harken.....	103,386	Rongeur, Leksell.....	213		
Rib Spreader Tuffier.....	104,385	Rongeur, Lempert.....	215,276		
Rib Spreader Wilson.....	104,386	Rongeur, Love-Kerrison-Schlesinger.....	219		
Rib Stripper Matson.....	387	Rongeur, Luer Bone.....	216		
Ribbon Scissors Iris.....	18,152	Rongeur, Mead.....	218,277		
Ribbon Scissors Stevens Tenotomy.....	18,152	Rongeur, No. 5.....	274		
Ribbon Scissors Stitch.....	18,24,152	Rongeur, Olivecrona.....	216		
Ribbon Scissors Strabismus.....	18	Rongeur, Ruskin.....	214,277		
Ribbon Zalkind Retractor.....	108	Rongeur, Ruskin-Liston.....	211		
Richardson Retractor.....	109	Rongeur, Schlesinger Cerv. Laminectomy.....	220		
Ridlon Plaster Knife.....	256	Rongeur, Sklar Double Action.....	212		
Rigby Retractor.....	100	Rongeur, Smith-Petersen Laminectomy.....	213		
Ring Crawford Suture.....	433	Rongeur, Stille.....	213		
Ring Curette.....	457	Rongeur, Stille-Liston.....	211		
Ring Curette Cone.....	235	Rongeur, Stille-Luer.....	214		
Ring Finger Cutter Keyes.....	496	Rongeur, Stille-Luer Echlin.....	214		
Ring Handle T-C Pin And Wire Extractor.....	288	Rongeur, Wilde Intervertebral Disc.....	223		
Ring Handle Wire Extractor T-C.....	252	Rongeur, Zaufel-Jansen.....	214,277		
Ring Laparotomy.....	334	Rongeur, Zielke Intervertebral.....	223		
Rings Fixation.....	131	Rosette Knife.....	457		
Rings Fixation Flieringa-Legrand.....	131	Rotatable Endoscopy Instruments.....	434-458		
Rings Fixation Mcneil-Goldman.....	131	Rotator Bechert Nucleus.....	143		
Rizzuti Iris Retractor & Lens Expressor.....	132	Roux Retractor.....	110		
Roberts Forceps.....	378	Rowland Bone Forceps.....	211,276		
Rochester-Carmalt Forceps.....	44	Rudd Clinic Hemorrhoidal Ligator.....	293		
Rochester Ochsner Forceps.....	44	Ruedemann Lachrymal Dilator.....	144		
Rochester-Ochsner Forceps Sklarlite™.....	472	Ruler Laser Depth And Width.....	365		
Rochester-Pean Forceps.....	43,367	Rumel Metal.....	174,498		
Rochester-Pean Forceps Laser.....	367	Rumel Tourniquet.....	392		
Rochester-Pean Sklarlite™ Forceps.....	472	Rush Mallet (Crane).....	278		
Roeder Towel Clamp.....	87,207	Ruskin Liston Forceps.....	275		
Rollet (Blair) Retractor.....	112	Ruskin-Liston Bone Cutting Forceps.....	211		
		Ruskin-Liston Rongeur.....	211		
		Ruskin Rongeur.....	214,277		
		Ruskin Splitting Forceps.....	211,275		

S

Saber Back Scissors Fomon.....	20,191
Sampling Set Endometrial Mi-Mark™.....	344
Santulli Bulldog Clamp.....	417
Sarot Needle Holder.....	89
Sarot Needle Holder T-C.....	93,96
Satinsky Cooley Anastomosis Forceps.....	423
Satinsky Scissors.....	30,392
Satinsky Vena Cava Clamp.....	405
Satterlee Bone Saw.....	249
Sauer Eye Speculum.....	129
Sauer Suturing Forceps.....	161
Saunders Instrument Rack.....	505
Saw Aseptic.....	250
Saw Bone.....	282
Saw Charriere Metacarpal Bone.....	249
Saw Guide Bailey Gigli.....	250
Saw Handle Gigli.....	250
Saw Joseph Bone.....	192,249,282
Saw Lagenbeck Bone.....	282
Saw Langenbeck Metacarpal.....	250
Saw Nasal Bosworth.....	192
Saw Oscillating Plaster.....	256,291
Saw Plaster Engel.....	256
Saw Plaster Wigmore.....	256
Saw Satterlee Bone.....	249
Saw Wire Gigli.....	250
Sawtell Applicator.....	184
Sawtell Tonsil Forceps.....	201
Sawyer Rectal Retractor.....	296
Sayre Elevator.....	246,270
Scalp Hemostat Dandy.....	47
Scalpel Blade Specialty.....	210
Scalpel Handles.....	208
Scalpel With Handle Attached.....	209
Scalpels.....	208-210
Scapula Retractor Davidson.....	116,389
Schaaf Foreign Body Forceps.....	78
Schamberg Comedone Extractor.....	495
Scheie-Westcott Corneal Section Scis.....	147,485
Schertl Fenestrated Grasping Forceps.....	437
Schiotz Tonometer.....	175
Schlesinger Cervical Laminectomy Rong.....	220
Schmeden Tonsil Punch.....	200
Schmidt Forceps.....	201,380
Schroeder (Braun) Tenac. Forceps.....	317,326

RONGEURS

Rongeur, Adson.....	216
---------------------	-----



Schroeder Tenaculum Forceps59
 Schroeder Tenaculum Forceps Laser366
 Schroeder Tenac. Forceps Sklar Blue™356
 Schroeder Vulsellum Forceps.....60,332,333
 Schubert-Van Doren Biopsy Punch343
 Schweiger Extra Capsular Forceps162
 Schweizer Forceps54,328
 Schweizer Forceps Laser368
 Schweizer Forceps Sklar Blue™357

SCISSORS

Scissors6-37
 Scissors, Ada Dissecting12
 Scissors, Aebli Corneal.....146
 Scissors, And NH Olsen-Hegar169
 Scissors, Angular Iris Probe Point149
 Scissors, Angular Sklar.....8
 Scissors, Arthroscopic459
 Scissors, Aufrecht Face Lift20
 Scissors, Bandage Sklarlite™ Lister.....26
 Scissors, Bantam Bandage27
 Scissors, Barraquer-Dewecker Iris485
 Scissors, Bellucci Micro Ear180
 Scissors, Boettcher Tonsil201
 Scissors, Braun Episiotomy29
 Scissors, Brown Dissecting21,191
 Scissors, Burnham Finger Bandage27
 Scissors, Caplan Dorsal191
 Scissors, Castroviejo31
 Scissors, Castroviejo Cataract.....146,484
 Scissors, Castroviejo Corneal.....146,484
 Scissors, Commander Utility.....27
 Scissors, Corneal Sect. Scheie-Westcott ...485
 Scissors, Cottle Dorsal21
 Scissors, Cottle Nasal.....21,191
 Scissors, Crown & Collar Cutting.....28,290
 Scissors, Curved Kelly306
 Scissors, Cuticle And Nail.....29
 Scissors, Dean.....30
 Scissors, Deaver Delicate.....8
 Scissors, DeBakey Endarterectomy432
 Scissors, DeBakey Vascular.....431
 Scissors, Delicate Lister Bandage26
 Scissors, Delicate Metzen. Diss.322,431
 Scissors, Delicate Operating6,7
 Scissors, Delicate Spencer Stitch.....23
 Scissors, Delicate Stevens Tenotomy148
 Scissors, Delicate Strabismus153
 Scissors, Delicate Suture.....24
 Scissors, Dewecker Iris149,485

Scissors, Dietrich Coronary Artery.....430
 Scissors, Dissecting Mayo-Noble305
 Scissors, Dissecting Mayo-Stille.....323
 Scissors, Dissecting Sealy.....152
 Scissors, Dissecting Sklar Edge™ T-C35
 Scissors, Dissecting Sklarlite™ XD Mayo ..464
 Scissors, Doyen.....12,306,323
 Scissors, Dura13
 Scissors, Endoscopy Hysteroscopy.....453
 Scissors, Enterotome.....29,306
 Scissors, Enucleation22
 Scissors, Essrig Dissecting.....12
 Scissors, Favaloro Vascular431
 Scissors, Felt And Moleskin.....28
 Scissors, Ferguson29
 Scissors, Fine Stitch486
 Scissors, Finochietto.....30,392
 Scissors, Fomon20,190,191
 Scissors, Gauze USA Pattern.....290
 Scissors, Goldman-Fox19
 Scissors, Gradle152,486
 Scissors, Haimovici.....30
 Scissors, Heath.....28
 Scissors, Hercules Utility257
 Scissors, Hill21
 Scissors, Hook.....439
 Scissors, Ingrown Nail Splitting29,265
 Scissors, Iris14,150
 Scissors, Iris Angular13
 Scissors, Iris Delicate15,150
 Scissors, Iris Knapp.....149
 Scissors, Iris Micro-Cut Sklarhone™37
 Scissors, Iris Micro-Miniature.....149,484
 Scissors, Iris Sklar Edge™ T-C35
 Scissors, Iris Sklarcut™33
 Scissors, Iris Sklarlite™14,150,463
 Scissors, Iris Sklarlite™ Sklarcut™33,468
 Scissors, Iris Wilmer22
 Scissors, Jacobson Spring Handle31
 Scissors, Joseph.....20,190
 Scissors, Kelly-Adson13,306,323
 Scissors, Knight Nasal.....21,190
 Scissors, Knowles Bandage27
 Scissors, La Grange22
 Scissors, Lister Bandage26,27
 Scissors, Martin19
 Scis., Mayo Diss.9,33,34,305,323,392,468
 Scissors, Mayo Dissecting Sklarcut™33
 Scissors, Mayo Dissecting Sklarlite™9,464
 Scissors, Mayo Micro-Cut Sklarhone™37

Scissors, Mayo-Noble Dissecting12
 Scissors, Mayo-Noble-Stille Diss....12,305,323
 Scis., Mayo-Stille Diss. Sklar Edge™ T-C34
 Scissors, McClure Spring Handle31,486
 Scissors, McGuire Corneal.....146
 Scissors, McPherson-Vannas.....31,151,484
 Scissors, Metzenbaum440,443
 Scissors, Metzenbaum (Nelson).....305
 Scissors, Metzen. Dissecting...11,190,322,465
 Scissors, Metzenbaum Lahey.....10
 Scissors, Metzen. Micro-Cut Sklarhone™37
 Scissors, Metzenbaum Sklarcut™ (Lahey)...33
 Scissors, Metzen. Sklarlite™ Sklarcut™33
 Scissors, Microsurgery480,481,486
 Scissors, Miller.....19,30,298
 Scissors, Mixer19
 Scissors, Moleskin28,292
 Scissors, Multi-Cut Utility28,259
 Scissors, Nail And Cuticle.....29
 Scissors, Noyes Iridectomy149,485
 Scissors, Operating6,7,322,440
 Scissors, Operating Sklarhone™36
 Scissors, Operating Sklarlite™ XD462
 Scissors, Operating T-C Sklar Edge™34
 Scissors, Peritoneal439
 Scissors, Plastic Surgery13
 Scissors, Potts-Smith.....30,429
 Scissors, Precision Sklar25
 Scissors, Ragnell Dissecting21,32
 Scissors, Reynolds19
 Scissors, Ribbon Iris152
 Scissors, Ribbon Stevens Tenotomy.....18
 Scissors, Ribbon Stitch.....18,24,152
 Scissors, Satinsky.....30,392
 Scissors, Scheie-Westcott Corneal Sect. ...147
 Scissors, Shepard-Westcott147,486
 Scissors, Sims13,306
 Scissors, Sistrunk22
 Scissors, Sklar Angular.....8,19
 Scissors, Sklar Hi Level Bandage.....27
 Scissors, Sklar Skin Flap19
 Scissors, Sklar Stitch24
 Scissors, Sklarcut™ Operating.....33
 Scissors, Sklarlite™ Lister Bandage.....467
 Scissors, Sklarlite™ Mayo Dissecting305
 Scissors, Sklarlite™ Metzen. (Lahey).....465
 Scissors, Sklarlite™ Operating.....6,7
 Scissors, Sklarlite™ Precision25
 Scis., Sklarlite™ Sklarcut™ Metz - Lahey ..468
 Scissors, Sklarlite™ Sklarcut™ Oper.33,468

Scis., Sklarlite™ Sklarcut™ Ragnell Diss.....	467	Scleral Wiener Hook.....	140	Shears Rib Collins.....	388
Scissors, Sklarlite™ Sklarcut™ Wagner.....	467	Scoop And Probe Moynihan.....	125	Shears Seutin Plaster.....	292
Scis., Sklarlite™ Spencer Stitch.....	23,151,466	Scoop Desjardin.....	125	Shears Stille Plaster.....	258
Scissors, Sklarlite™ Stevens Tenotomy.....	464	Scoop Ferguson.....	125	Shears Stille Rib.....	388
Scissors, Sklarlite™ Strabismus.....	153,463	Scoop Mayo Gallstone.....	125	Shears Utility Commander.....	257
Scissors, Sklarlite™ Suture.....	151,466	Screw Oral Plastic.....	197	Sheehan Osteotome.....	229
Scissors, Sklarlite™ XD Lister Bandage.....	467	Scribe™ Skin Marker Sklar.....	497	Sheet Bethea Holder.....	374
Scissors, Sklarlite™ XD Metzen. (Lahey).....	465	Scudder Forceps.....	51	Shepard IOL Inserting Forceps.....	167
Scissors, Sklarlite™ XD Operating.....	6	Sealy Dissecting Scissors.....	152	Shepard-Westcott Scissors.....	147,486
Scissors, Sklarlite™ XD Spencer Stitch.....	23	Section Scissors Corneal Scheie-Westcott.....	147	Shield Eye Aluminum Fox.....	174
Scissors, Sklarlite™ XD Strabismus.....	153	Sedillot Elevator.....	244	Shields Disposable Eye.....	174
Scissors, Sklarlite™ XD Strabismus.....	463	Sedillot Periosteal Elevator.....	246	Short Vascular Dilators.....	428
Scissors, Sklarlite™ XD Suture.....	24	Segond (Collin) Forceps.....	59,333	Side Cut T-C Pin Cutter.....	251,289
Scissors, Spencer Stitch.....	151	Segond Vaginal Spatula.....	312	Silver Osteotome.....	193,229
Scissors, Spring Handle McClure.....	152	Seldin Elevator.....	246	Sim Rectal Speculum.....	296
Scissors, Spring Handle Vannas.....	31	Self Retaining Retractor.....	101,196,238,491	Simcoe Cannula.....	173
Scissors, Spring Handle Vascular.....	429	Self-Retaining Retractor Alm.....	101	Simcoe Irrigating/Aspirating Cannula.....	173
Scissors, Stevens Tenotomy.....	16	Self-Retaining Retractor Holzheimer.....	101	Simcoe Nucleus Delivery Cannula.....	173
Scissors, Stitch Fine.....	151	Self-Retaining Retractor Jansen.....	101	Simcoe Nucleus Forceps.....	158
Scissors, Stitch Spencer.....	23	Self-Retaining Retractor Weitlaner.....	100	Simcoe Nucleus Loop.....	139
Scissors, Strabismus.....	17,153	Selman Forceps.....	391	Simpson Obstetrical Forceps.....	371
Scissors, Strabismus Ribbon.....	18	Semb Bone Holding Forceps.....	238	Simpson Uterine Sound Malleable.....	317
Scissors, Strabismus Sklar Edge™ T-C.....	35	Semb Dissecting Forceps.....	53,390	Simpson-Luikart Obstetrical Forceps.....	370
Scissors, Strabismus Sklarlite™.....	17	Semb Raspatory.....	387	Sims-Kelly Retractor.....	115,311
Scissors, Sullivan.....	323	Semi-Rigid Hysteroscopy Instrument.....	453	Sims Retractor.....	115,353
Scissors, Suture.....	24,151	Semkin Dressing Forceps.....	73	Sims Scissors.....	13,306
Scissors, Suture Sklarlite™.....	24,466	Senn Retractor.....	105	Sims Uterine Curettes.....	321
Scissors, Suture Wire Cut.....	23,28,119,251,290	Separator Benson Pylorus.....	52	Sims Uterine Sound.....	317
Scissors, Sweet 45° Angle.....	306,323,392	Septal Cottle Speculum.....	185	Sims Vaginal Retractor.....	311
Scissors, Sweet Angled.....	29	Septal Cottle Speculum Laser.....	185	Singley/Tuttle Forceps Laser.....	367
Scissors, Tenotomy Ribbon Stevens.....	152	Septum Chisel Hajek.....	195	Sinskey Lens Manipulating Hook.....	142
Scissors, Tenotomy Stevens.....	148,464	Septum Elevator Ballenger.....	188	Sinskey Micro Iris Hook.....	141
Scissors, Thin Point Diss. Glassman.....	190	Septum Elevator Freer.....	188	Sistrunk Scissors.....	22
Scissors, Thorek.....	30,124	Septum Forceps Jansen-Middleton.....	192	Skeele Curette.....	141
Scissors, Tonsil Dean.....	201	Septum Forceps Knight.....	186	Skene Uterine Curette.....	320
Scissors, Umbilical.....	29	Septum Knife Freer.....	188,195	Skid Bone Moore.....	243
Scissors, USA Pattern Gauze.....	28,259	Septum Straightening Forceps Ash.....	192	Skid Bone Murphy-Lane.....	241
Scissors, Utility.....	18	Sequestrum Forceps Van Bruen.....	239	Skid Meyerding.....	241
Scissors, Utility Hercules.....	292	Sesamoid Clamp.....	240,285	Skin Flap Scissors Sklar.....	19
Scissors, Vannas.....	151	Seutin Plaster Shears.....	257,292	Skin Graft. Knife Potter Bodenham Humby.....	496
Scissors, Vannas Spring Handle.....	31,151,484	Shaaf Foreign Body Forceps.....	161	Skin Hook And Retractor Meyerding.....	106
Scissors, Vascular DeBaKey.....	430	Shallcross Forceps.....	48,124	Skin Hook Gillies.....	112
Scissors, Vet.....	22	Shapleigh Ear Curettes.....	177	Skin Hook Joseph.....	112,196
Scissors, Wagner.....	8	Sharpening Stone.....	496	Skin Marker Surgical SklarScribe™.....	497,529
Scissors, Wagner Sklarcut™ Sklarlite™.....	32	Shears Bethune Rib.....	388	Sklar Allis Forceps.....	61
Scissors, Westcott.....	147	Shears Bruns.....	257,292	Sklar Angular Scissors.....	8,19
Scissors, Westcott Tenotomy.....	31,147,485	Shears Commander Utility.....	27,292	Sklar Antimicrobial Soap.....	521,525
Scissors, Wilmer.....	152,485	Shears Coryllos Rib.....	388	Sklar Biopsy Punch Wide Bite Oval.....	338
Scissors, Wire Cutting Sklar Edge™ T-C.....	35	Shears Esmarch.....	257,292		
Scleral Forceps Girard Corneal.....	158	Shears Felt.....	292	SKLAR BLUE™	
Scleral Hook Berens.....	140	Shears Gluck Rib.....	388	Sklar Blue™ Adson Forceps.....	356
Scleral Twist Fixation Hook.....	143	Shears Plaster Seutin.....	257	Sklar Blue™ Auvard Vaginal Speculum.....	351



Sklar Blue™ Bozeman Forceps.....	356
Sklar Blue™ Champion Grasping Forceps.....	356
Sklar Blue™ Cervical Hook	355
Sklar Blue™ Cervical Manipulator	355
Sklar Blue™ Clemetson Forceps.....	357
Sklar Blue™ Collin Vaginal Speculum.....	350
Sklar Blue™ Cusco Vaginal Speculum.....	350
Sklar Blue™ Emmett Hooks	353,354
Sklar Blue™ Forceps.....	357
Sklar Blue™ Freeway Graves Vag. Spec.....	349
Sklar Blue™ Freeway Vaginal Speculum.....	349
Sklar Blue™ Graves Vaginal Spec.	346,348
Sklar Blue™ Graves Vag. Spec. Wide View	349
Sklar Blue™ Iris Hook.....	354
Sklar Blue™ Jackson Vaginal Retractor.....	353
Sklar Blue™ Kogan Endospeculum.....	352
Sklar Blue™ Lateral Vaginal Retractor.....	350
Sklar Blue™ Laufe Uterine Polyp Forceps ..	357
Sklar Blue™ Maxi Iris Hook.....	354
Sklar Blue™ McGee Lateral Vaginal Retr. ...	350
Sklar Blue™ Mini Emmett Hook	354
Sklar Blue™ Offset Hook.....	355
Sklar Blue™ Pederson Vaginal Spec.	347,348
Sklar Blue™ Potts-Smith Forceps	356
Sklar Blue™ Schroeder Tenac. Forceps	356
Sklar Blue™ Schweizer Forceps	357
Sklar Blue™ Sims Retractor	353
Sklar Blue™ Smoke Evacuation Tube.....	349
Sklar Blue™ Smoke Evac. Tube Holder.....	349
Sklar Blue™ Steiner-Auvard Vaginal Spec.....	351
Sklar Blue™ Tuttle/Singley Forceps	357
Sklar Blue™ Vaginal Spatula.....	350
Sklar Blue™ Wand Clamp	349
Sklar Bone Drill-Offset Handle.....	253,286
Sklar Cervical Hook	113
Sklar Cervical Manipulator	113
Sklar Cheek Retractor	197
Sklar Clamp Application Forceps.....	477
Sklar Comedone Extractor.....	495
Sklar Cream™	525
Sklar Dermal Curette	281

SKLAR DIAMOND™

Sklar Diamond™ Blade Micrometer Knife ...	172
Sklar Diamond™ Blades.....	170
Sklar Diamond™ Titanium Phanco Knife	171
Sklar Diamond™ Titanium Step Knife	171
Sklar Disinfectant™	516,519,525
Sklar Disinfecting Soak.....	510
Sklar Double Action Rongeur	212
Sklar Double-Action Littauer Cutting Fcps...	261

SKLAR EDGE™

Sklar Edge™ T-C Dissecting Scissors	35
Sklar Edge™ T-C Iris Scissors	35
Sklar Edge™ T-C Mayo Diss. Scissors	34
Sklar Edge™ T-C Mayo-Stille Diss Scissors ..	34
Sklar Edge™ T-C Metzen. Diss. Scissors	35
Sklar Edge™ T-C Operating Scissors	34
Sklar Edge™ T-C Strabismus Scissors	35
Sklar Edge™ T-C Wire Cutting Scissors	35
Sklar Edge™ Tungsten Carbide (T-C) Scis. ...	34
Sklar Enzymatic.....	512,520,524
Sklar Fenestrated Retractor.....	106,390
Sklar Finger Nail Drill	496
Sklar Finger Ring Cutter	496
Sklar Forceps Holder	505
Sklar Forceps Improved.....	287
Sklar Hemorrhoidal Forceps	293
Sklar Hi-Level Bandage Scissors	27
Sklar ID Tape.....	501
Sklar Instru-Guard™ Dual Enzym. Deter.....	527
Sklar Instru-Guard™ One-Step	526
Sklar Intestinal Forceps	52
Sklar Kevorkian Biopsy Punch.....	339

SKLAR KLEEN™

Sklar Kleen™	510
Sklar Kleen™ LF Deter. for Instr.....	513,520,524
Sklar Kleen™ Liq. Deter. for Instr.	513,521,524
Sklar Kleen™ Pow. Det. for Instr.	513,520,524
Sklar Laser Black Allis Forceps	299
Sklar Laser Black Babcock Forceps	299
Sklar Laser Black Dressing Forceps.....	299
Sklar Laser Black Surgery Forceps	299
Sklar Lateral Vaginal Retractor.....	309
Sklar Litegrip™ Adson Forceps	68
Sklar Litegrip™ Adson-Brown Forceps.....	68
Sklar Litegrip™ Bishop-Harmon Forceps	68
Sklar Litegrip™ Iris Forceps	68,156
Sklar Lgrip™ T-C Adson-Brn. Tis. Fcps ...	68,85
Sklar Lube™	510
Sklar Mallet.....	232
Sklar Measured Dose Delivery Syringe	316
Sklar Meniscus Clamp	247
Sklar Micro-Cut Kevorkian Biopsy Punch	339
Sklar Micro-Cut Oval Biopsy Punch Tisch. ...	337
Sklar Micro-Grip™ Micro. Fcps.....	482,483
Sklar Mini-Dilator/OS Finder Set.....	317
Sklar Mini Endocervical Curette.....	320
Sklar Mini Tischler Delicate Punch	335
Sklar Nail Splitter	262
Sklar Neuro Retractor	225
Sklar Non-Slip Tissue Forceps	74

Sklar Osteotome	229
Sklar Oval Biopsy Punch	338
Sklar Pin Cutter.....	251,289
Sklar Polish™ for Instruments	514,521,525
Sklar Polyethylene Headband	498
Sklar Precision Scissors	25
Sklar Rankin Forceps	49
Sklar Rectal Biopsy Punch Yeoman.....	297
Sklar Release Pattern Tissue Hooks	113
Sklar Scribe™ Skin Marker.....	497
Sklar Skin Flap Scissors	19
Sklar Soak™	511,518,524
Sklar Soak™ Disinf. for Instr.....	510,511,518,524
Sklar Soap™	521
Sklar Special Hemostatic Forceps.....	382
Sklar Splinter Removal Kit.....	81,493
Sklar Stitch Scissors	24
Sklar T-C Sternal Wire Twister	433
Sklar Tendon Clamp.....	247
Sklar Thoracic Clamp	53,390
Sklar Tischler Oval Biopsy Punch.....	337
Sklar Tissue Forceps	79
Sklar Titanium-Nitride Littauer Cutt Fcps.....	261
Sklar Towel Clamp Cross Action	87
Sklar Tubing Forceps.....	86
Sklar Wide Bite Oval Biop. Punch Tisch.....	337

SKLARCUT™

Sklarcut™ Iris Scissors.....	33
Sklarcut™ Mayo Dissecting Scissors	33
Sklarcut™ Metzenbaum (Lahey) Scissors.....	33
Sklarcut™ Operating Scissors.....	33
Sklarcut™ Ragnell Dissecting Scissors.....	32
Sklarcut™ Scissors	32-33
Sklarcut™ Wagner Scissors	32
Sklarcut™ Sklarlite™ Iris Scissors	33,468
Sklarcut™ Sklarlite™ Mayo Diss. Scis.	33,486
Sklarcut™ Sklarlite™ Metzenbaum Scis.	33
Sklarcut™ Sklarlite™ Oper. Scis.	33,468
Sklarcut™ Sklarlite™ Ragnell Diss. Scis.....	32,467
Sklarcut™ Sklarlite™ Wagner Scis.	32,467

SKLARGRIP™

Sklargrip™ Handle Deaver Retractor	108
Sklargrip™ Handle Sims Retractor.....	115
Sklargrip™ T-C Baumgartner NHolder	93
Sklargrip™ T-C Crile-Murray NHolder	92
Sklargrip™ T-C DeBaKey Needle Holder	93
Sklargrip™ T-C Derf Needle Holder	92
Sklargrip™ T-C Halsey Needle Holder	93

Skलगrip™ T-C Heaney Needle Holder.....93
 Skलगrip™ T-C Mayo-Hegar NHolder93
 Skलगrip™ T-C Sarot Needle Holder93
 Skलगrip™ T-C Wangenstein NHolder.....93
 Skलगrip™ T-C Webster Needle Holder.....92
 Skलगuard™ Tip Protectors502-503

SKLARHONE™

Skларhone™ Micro-Cut Mayo Scissors37
 Skларhone™ Micro-Cut Metzenbaum Scis.37
 Skларhone™ Micro-Cut Operating Scissors ...36
 Skларhone™ Operating Scissors.....36

SKLARLITE™

Skларlite™ Adson Forceps66,473
 Skларlite™ Allis Tissue Forceps62,284,474
 Skларlite™ Crile Hemostatic Forceps40,470
 Skларlite™ Dressing Forceps474
 Skларlite™ Dressing Forceps70,474
 Skларlite™ Extra Delicate Iris Scissors.....150
 Skларlite™ Extra Delicate Strabismus Scis. .153
 Skларlite™ Forceps38
 Skларlite™ Halsted Mosq. Hemo. Fcps ...38,469
 Skларlite™ Hartmann Mos. Hemostats...42,469
 Skларlite™ Ingrown Toe Nail Forceps265
 Skларlite™ Instruments461-474
 Skларlite™ Iris Scissors14,150,463
 Skларlite™ Kelly Hemostatic Forceps.....41,470
 Skларlite™ Lister Bandage Scissors.....26,467
 Skларlite™ Littauer Cutting Forceps260
 Skларlite™ Mayo Dissecting Scis.9,305,464
 Skларlite™ Metzen. Lahey Scis.10,11,465
 Skларlite™ Mixer Forceps.....46,471
 Skларlite™ Operating Scissors6,7,462
 Skларlite™ Precision Scissors25
 Skларlite™ Rochester Ochsner Forceps .44,472
 Skларlite™ Rochester Pean Forceps.....43,472
 Skларlite™ Scissors.....14
 Skларlite™ Skларcut™ Iris Scissors33,468
 Skларlite™ Skларcut™ Mayo Diss. Scis. ...33,468
 Skларlite™ Skларcut™ Metzen. Scis.33,468
 Skларlite™ Skларcut™ Operating Scissors ...468
 Skларlite™ Skларcut™ Ragn. Diss. Scis. .32,467
 Skларlite™ Skларcut™ Wagner Scis.32,467
 Skларlite™ Spencer Stitch Scissors .23,151,466
 Skларlite™ Stevens Teno. Scis.16,148,464
 Skларlite™ Strabismus Scissors.....17,153,463
 Skларlite™ Suture Scissors24,151,466
 Skларlite™ Tissue Forceps.....71,473
 Skларlite™ Tissue Nipper264
 Skларlite™ XD Adson Forceps67,473
 Skларlite™ XD Allis Tissue Forceps63,474

Skларlite™ XD Crile Hemo. Forceps40,470
 Skларlite™ XD Tissue Forceps.....71
 Skларlite™ XD Dressing Forceps70,474
 Skларlite™ XD (Extra Delicate) Forceps.....39
 Skларlite™ XD Halsted Mosq. Forceps ...39,469
 Skларlite™ XD Hartmann Mosq. Fcps42,469
 Skларlite™ XD Iris Scissors15,463
 Skларlite™ XD Kelly Hemo. Fcps41,470
 Skларlite™ XD Lister Bandage Scis.26,467
 Skларlite™ XD Mayo Dissecting Scis.9,464
 Skларlite™ XD Metzen. Diss. Scis.....10,11,465
 Skларlite™ XD Mixer Forceps.....46,471
 Skларlite™ XD Operating Scissors6,7,462
 Skларlite™ XD Precision Scissors25
 Skларlite™ XD Rochester Pean Fcps.....43,472
 Skларlite™ XD Rochester-Ochsner Fcps472
 Skларlite™ XD Spencer Stitich Scis23,466
 Skларlite™ XD Stevens Teno Scis ...16,148,464
 Skларlite™ XD Strabismus Scissors.....17,463
 Skларlite™ XD Suture Scissors24,466
 Skларlite™ XD Tissue Forceps.....473
 SkларScribe™ Surgical Skin Marker.....529

SKLARTECH 1000™

SkларTech 1000™ Endoscopic Instr434-441
 SkларTech 2000™ Endoscopic Instr442-444
 SkларTech 3000™ Endoscopic Instr454-456
 Sleeve Reducing - Endoscopy.....451
 Smilie Knife.....457
 Smilie Meniscus Hook Retractor.....243
 Smillie Meniscus Knife.....248
 Smith Peterson Gouge226
 Smith Peterson Osteotome.....226
 Smith-Fisher Iris Spatula138
 Smith-Petersen Laminectomy Rongeur.....213
 Smoke Disposable Evac. Tubing.....349,360
 Smoke Evacuation Tube Holder Laser361
 Smoke Evac. Tube Holder Skлар Blue™349
 Smoke Evacuation Tube Laser.....361
 Smoke Evacuation Tube Skлар Blue™349
 Snap Lock Pin/Wire Extractor.....252,289
 Snare Eves Tonsil.....198
 Snare Krause Ear181
 Snare Krause Nasal.....188
 Snare Tyding Tonsil.....198
 Snare Weston Rectal.....297
 Snare Wires Cut & Bent.....198
 Snellen Entropium Forceps166
 Soap, Skлар Antimicrobial.....521,525
 Soft Corn Knife268
 Sonoscope Adult.....500
 Sound Malleable Simpson Uterine317

Sound Sims Uterine.....317
 Sound Urethral Otis/Dittel302
 Sound Urethral Van Buren.....301
 Spatula And Hook McReynolds138
 Spatula And Packer266
 Spatula And Probe.....266,267
 Spatula Barraquer Cyclodialysis138
 Spatula Elschnig Cyclodialysis138
 Spatula Green.....138
 Spatula Iris Smith-Fisher138
 Spatula Segond Vaginal312
 Spatula Skлар Blue™ Vaginal.....350
 Spatula Tauber Vaginal312
 Spatula Vascular Thrombectomy.....432
 Spatulas Castroviejo Cyclodialysis138
 Spear Point Probe121

SPECULUM

Speculum, Auvard Weighted Vaginal310
 Speculum, Barraquer Wire128
 Speculum, Berlind-Auvard Weighted Vag. .310
 Speculum, Bodenhammer Rectal296
 Speculum, Boucheron Ear.....176
 Speculum, Brinckerhoff.....295
 Speculum, Castroviejo.....130
 Speculum, Chelsea Eaton Anal295
 Speculum, Collin Vaginal.....308
 Speculum, Cottle Septal Black Finish.....185
 Speculum, Cusco Vaginal.....309
 Speculum, Cusco Vaginal Skлар Blue™350
 Speculum, Devilbiss Vaginal309
 Speculum, Eye Cook128
 Speculum, Eye Wiener128
 Speculum, (Fansler) Ives Rectal293-295
 Speculum, Freeway Graves Vaginal307
 Speculum, Gerzog Nasal.....186
 Speculum, Graves Disposable530
 Speculum, Graves Vaginal307
 Speculum, Graves Vaginal Skлар Blue™ ...348
 Speculum, Gruber Ear176
 Speculum, Gutmann Vaginal.....309
 Speculum, Halle Nasal185
 Speculum, Henrotin Weighted Vaginal310
 Speculum, Hinkle-James295
 Speculum, Infant Ear176
 Speculum, Knapp Eye129
 Speculum, Kogen Endocervical.....313
 Speculum, Kratz-Barraquer Wire Eye.....128
 Speculum, Lancaster Eye.....130
 Speculum, Laser Auvard Vaginal361
 Speculum, Laser Freeway Graves Vag.360
 Speculum, Laser Graves Vaginal358



Speculum, Laser Graves Wide View	360	Splinter Forceps Feilchenfeld	81	Steel Bone Mallet.....	232
Speculum, Laser Lateral Vaginal.....	361	Splinter Forceps Fine Point	81,493	Steel Ruler	174
Speculum, Laser Pederson Vaginal	358	Splinter Forceps Plain With Magnifier.....	81,493	Steiner-Auvarad Vaginal Speculum Laser.....	361
Speculum, Marlow Laser Black Anal	299	Splinter Peet Forceps	494	Steiner-Auvarad Vag. Spec. Sklar Blue™	351
Speculum, McKinney Eye	128	Splinter Physicians Forceps	494	Steiner-Auvarad Weighted Vag. Spec.	310
Speculum, Mcpherson Eye.....	129	Splinter Pick Vanguard	81	Steinmann Pin Chuck	254
Speculum, Mellinger	129	Splinter Removal Kit Sklar	81	Steinmann Pins.....	286
Speculum, Murdock Eye.....	128	Splinter Sklar Removal Kit.....	493	Sterilizer Forceps.....	504
Speculum, Nasal Killian.....	185	Splinter Virtus Forceps	494	Sterilizing Instrument Tray.....	506-508
Speculum, Park-Guyton.....	130	Splinter Williams (Stieglitz) Forceps	494	Sternal Lemmon Approximator	387
Speculum, Park-Maumenee Eye	130	Splitter Nail Sklar	262,268	Sternal T-C Sklar Wire Twister	433
Speculum, Pederson Vaginal	308	Splitting Forceps Ruskin	211,275	Sternum Chisel Lebsche.....	388
Speculum, Pederson Vag. Sklar Blue™	348	Sponge Forceps Ballenger	86,504	Stethoscope Delee-Hillis Obstetrical	500
Speculum, Plain Wire	129	Sponge Forceps Foerster	86	Stethoscope For Fetal Heart Leff.....	500
Speculum, Pratt Rectal.....	296	Sponge Forceps Peanut.....	86,504	Stethoscope Magnatone.....	500
Speculum, Sauer Eye.....	129	Spoon And Hook Gross	181	Stethoscope Nurse'S Lightweight.....	499
Speculum, Septal Cottle	185	Spoon And Needle Fisher.....	138	Stethoscope Physician's.....	499
Speculum, Sim Rectal	296	Spoon Arthroscopic Curved.....	457	Stethoscope Pinard For Fetal Heart	499
Speculum, Sklar Blue™ Collin Vaginal.....	350	Spoon Daviel Lens.....	139	Stethoscope Sprague-Rappaport	500
Speculum, Sklar Blue™		Spoon Knapp Lens	139	Stevens Iris Forceps.....	155
Freeway Graves Vaginal	349	Spoon Mayo Common Duct.....	125	Stevens Needle Holder.....	90,169,492
Speculum, Sklar Blue™ Graves Vaginal	346	Spoons Evisceration Bunge.....	141	Stevens Ribbon Tenotomy Scissors.....	18
Speculum, Sklar Blue™ Pederson Vag.	347	Sprague-Rappaport Stethoscope	500	Stevens Sklarlite™ Tenotomy Scis.....	148,464
Speculum, Sklar Blue™		Spreader Beeson Plaster.....	259	Stevens Tenotomy Hook	140
Vaginal Steiner-Auvarad.....	351	Spreader Harken Rib	386	Stevens Tenotomy Scissors	16,148,464
Speculum, Steiner-Auvarad Weighted Vag.	310	Spreader Heavy Duty Cast.....	258,291	Stevenson Retractor	133
Speculum, Steiner-Sklar Weighted Vag.	310	Spreader Hennig Plaster	259,291	Stille Kidney Clamp.....	51,127
Speculum, Toynbee Ear	176	Spreader Inge	288	Stille Plaster Shears	258
Speculum, Vaginal Freeway Sklar Blue™	349	Spreader Lamina	240	Stille Rib Shears	388
Speculum, Vaginal Laser Collin.....	361	Spreader Rib Burford-Finochietto	385	Stille Rongeur	213
Speculum, Vaginal Laser Graves	360	Spreader Rib Finochietto	385	Stille Tissue Forceps	72
Speculum, Vaginal Laser Pederson	359,360	Spreader Rib Wilson.....	386	Stille Type Chisel	227
Speculum, Vaginal Laser Steiner-Auvarad...361		Spreader Tuffier Rib	385	Stille Type Gouge	227
Speculum, Vaginal Sklar Blue™ Auvarad	351	Spreader Walton Plaster.....	259,291	Stille Type Osteotome	227
Speculum, Vienna Nasal	185	Spreader Walton Plaster.....	291	Stille-Horsley Bone Cutting Forceps.....	211
Speculum, Weeks Eye.....	130	Spring Handle Scissors Jacobson	31	Stille-Liston Rongeur	211
Speculum, Weighted Vaginal Garrigue.....	310	Spring Handle Scissors McClure.....	31,152,486	Stille-Luer Echlin Rongeur	214
Speculum, Wide View Pattern Graves.....	307	Spring Handle Scissors Vannas	31,151,484	Stille-Luer Rongeur	214
Speculum, Wide View		Spring Handle Vascular Scissors	429	Stitch Fine Scissors	151
Sklar Blue™ Graves Vaginal	349	Spud Alvis Foreign Body	137	Stitch Ribbon Scissors.....	24,152
Speculum, Williams	130	Spud And Needle Dix	135	Stitch Scissors Ribbon.....	18
Speculum, Wire Barraquer	128	Spud Body Foreign Davis	135	Stitch Scissors Sklar.....	24
Speculum, Ziegler.....	129	Spud Body Foreign Francis	135	Stitch Scissors Spencer.....	23,151,466
Spencer Chalazion Forceps	165	Spud Foreign Body Laforce	135	Stockman (Zipser) Penis Clamp	303
Spencer Stitch Scissors.....	23,151	Square End Pliers.....	252,287	Stone Forceps Randall	49
Spencer Stitch Scissors Sklarlite™	23,466	St. Vincent Tubing Forceps	86	Stone Sharpening	496
Sphere Introducer Carter	164	Stabler B-Clip Remover - Endoscopy	452	Stopcock Two Way	448
Spinal Gouge Cobb Type	229	Stainless Suture Wire	120,290	Strabismus Forceps	78
Spinal Retractor Taylor	243	Stand Cover For Schiotz Tonometer	175	Strabismus Hook Green	140
Splanchnic Retractor Harrington.....	389	Standard Bur.....	271	Strabismus Scissors	17,153
Splinter Feilchenfeld Forceps	493	Stangel-Barraquer Needle Holder	91	Strabismus Scissors Ribbon.....	18
Splinter Forceps Carmalt.....	81,493	Stauda Tenaculum Forceps.....	65,326	Strabismus Scissors Sklar Edge™ T-C	35

Strabismus Scissors Sklarlite™	17,463
Stratte Needle Holder	324
Stratte Needle Holder T-C	96
Strelis Vascular Forceps	432
Stringers Instrument	505
Stripper Matson Rib	387
Stripper Tendon Bunnell	247
Struycken Cutting Forceps	187
Subramanian Miniature Aorta Clamp	419

SUCTION TUBES

Suction Coagulation Tube	
With Trumpet Valve	447
Suction Tube Adson	117
Suction Tube Baron	117
Suction Tube Baron	492
Suction Tube Buie	117,297
Suction Tube Frazier	117
Suction Tube Poole	117
Suction Tube Yankauer	117
Suction/Irrigation Cannula	449
Suction/Irrigation Tube	450
Sullivan Scissors	323
Suprapubic And Bladder	
Retractor Judd-Masson	304
Surgeons Brush	509
Surgical Blades	208
Surgical Skin Marker SklarScribe™	529
Suture Forceps Castroviejo	83
Suture Forceps Castroviejo	159
Suture Forceps Ear And Eye Manhattan	161
Suture Forceps Healy	83
Suture Forceps Healy	119
Suture Forceps Litegrip™	
Adson-Brown T-C	68
Suture Forceps Walton	160
Suture Instruments	119-120
Suture Ring Crawford	433
Suture Scissors	24,151,466
Suture Tying Forceps Micro	83
Suture Wire Cut. Scis.	23,28,119,251,290
Suture Wire Stainless	120,290
Suturing Forceps Bonn Micro	159
Suturing Forceps Micro Iris McPherson	159
Suturing Forceps Sauer	161
Sweet Scissors Angled	29,306,323,392
Swiss Model Blade Breaker	137
Swivel Knife Ballenger	189
Syringe, Ear Apparatus Continuous	182
Syringe, Pomeroy All Metal Ear	182
Syringe, Sklar Measured Dose Delivery	316

T

TUNGSTEN CARBIDE INSTRUMENTS

T-Shaped Clamp Pratt	303
T-C Adson Dressing Forceps	85
T-C Alligator Action Needle Holder	98
T-C Allis Forceps	84
T-C Anastomosis Needle Holder	325
T-C Babcock Forceps	84,285
T-C Baumgartner Needle Holder	93,95
T-C Bozeman-Heaney Needle Holder	98,325
T-C Castroviejo Needle Holder	97
T-C Crile-Murray Needle Holder	92,94
T-C Crile-Wood Needle Holder	95
T-C DeBakey Forceps	84,334
T-C Derf Needle Holder	94,94
T-C Double Action Wire Extraction Pliers	288
T-C Dressing Forceps	85
T-C Finochietto Needle Holder	96
T-C Halsey Needle Holder	93,95
T-C Heaney Needle Holder	93,96
T-C Iris Scissors Sklar Edge™	35
T-C Jacobson Needle Holder	97
T-C Luethy Beck Needle Holder	98,325
T-C Maltz Rasp	273
T-C Mathieu Needle Holder	98
T-C Mayo Dissecting Scis. Sklar Edge™	34
T-C Mayo-Hegar Needle Holder	93,95
T-C Mayo-Stille Diss Scissors Sklar Edge™	34
T-C Metzbaum Diss. Scis. Sklar Edge™	35
T-C New Orleans Needle Holder	95
T-C Olsen-Hegar Needle Holders	96
T-C Operating Scissors Sklar Edge™	34
T-C Pin Cutter	251,289
T-C Potts-Smith Dressing Forceps	85
T-C Ring Handle Wire Extractor	252,288
T-C Ryder Needle Holder	95
T-C Sarot Needle Holder	93,96
T-C Sklar Edge™ Dissecting Scissors	35
T-C Sklar Sternal Wire Twister	433
T-C Strabismus Scissors Sklar Edge™	35
T-C Stratte Needle Holder	96
T-C Wangenstein NHolder Sklargrip™	93
T-C Webster Needle Holder	92,94
T-C Wire And Pin Cutter	251
T-C Wire Cutting Scissors Sklar Edge™	35
T-C Wire Puller	252
T-Shape Clamp Pratt	124
Takahashi Forceps	186
Tamper, Bone	231
Tangential Occlusion DeBakey	404

Tape Measure Retractable	497
Tauber Vaginal Spatula	312
Taylor Percussion Hammer	497
Taylor Spinal Retractor	243
Teale Vulsellum Forceps	60,327
Temple-Fay Retractor	103

TENACULUM FORCEPS

Tenaculum Forceps	64
Tenaculum Forceps (Braun) Schroeder	317
Tenaculum Forceps Adair Breast	64
Tenaculum Forceps Barrett	60,326
Tenaculum Forceps Duplay	59,326
Tenaculum Forceps Graves	59
Tenaculum Forceps Jarcho	326
Tenaculum Forceps Laser Graves	366
Tenaculum Forceps Laser Schroeder	366
Tenaculum Forceps Schroeder	59,326
Tenaculum Fcps Sklar Blue™ Schroeder	356
Tenaculum Forceps Staude	65,326
Tenaculum Jackson	111,205
Tenaculum Laser Hooks	365
Tendon Clamp Sklar	247
Tendon Forceps Larsen	248
Tendon Passing Probe W/Eye And Grv.	249
Tendon Retriever Buck-Gramcko	248
Tendon Stripper Bunnell	247
Tendon Transplantation Forceps Platt	247
Tennant Anchor Lens Insertion Hook	142
Tennant-Troutman Superior	
Rectus Forceps	164
Tennant Tying Forceps	160,489
Tenotomy Hook O'Conner Flat	140
Tenotomy Hook Stevens	140
Tenotomy Scissors Stevens	16,148,152,464
Tenotomy Scissors Westcott	31,485
Textor Vasectomy Clamp	303
Thomas Uterine Curettes	321
Thompson Mosquito Forceps	45
Thoms-Gaylor Biopsy Forceps	298
Thoracic	375-392
Thoracic Clamp Sklar	53,390
Thoracic DeBakey-McQuigg-Mixer Clamp	420
Thoracic Retractor Harrington	116
Thorek Scissors	30,124
Thorpe Caliper	174
Thorpe Corneoscleral Forceps	77,161
Throat & Mouth Instruments	203
Thrombectomy Spatula Vascular	432
Tibia Retractor Bennett	242
Tie Director And Tongue	121
Tightener Harris Wire Knot	253



Tip Protectors Non-Vented Sklarguard.....	503
Tip Protectors Vented Sklarguard.....	502
Tischler Cervical Biopsy Punch	335
Tischler Oval Biopsy Punch	
Micro-Cut Sklar	337
Tischler Oval Biopsy Punch	
Sklar Wide Bite	337
Tischler Punch Sklar Delicate Mini	336
Tischler Wide Bite Mini Delicate Punch	336
Tissue Allis Forceps.....	327,357,474

TISSUE FORCEPS

Tissue Forcep Sklar Litegrip™	
T-C Adson Brown	85
Tissue Forceps Adson	66,85
Tissue Forceps Adson Laser	367
Tissue Forceps Allis.....	62,63,284,473
Tissue Forceps Bonney	73
Tissue Forceps Boys-Allis	61
Tissue Forceps Brown	73
Tissue Forceps Cooley Vascular	394,426
Tissue Forceps DeBakey	
Atraumatic	75,367,393-395
Tissue Forceps Delicate	71
Tissue Forceps Essrig	72
Tissue Forceps Eye	77
Tissue Forceps Ferris-Smith.....	334
Tissue Forceps Harrington-Mayo Bayonet ..	391
Tissue Forceps Lane	72
Tissue Forceps Litegrip™	
T-C Adson-Brown	68
Tissue Forceps Michel.....	72
Tissue Forceps Russian	73
Tissue Forceps Sklar	79
Tissue Forceps Sklar Non-Slip	74
Tissue Forceps Sklarlite™	71
Tissue Forceps Sklarlite™ Allis	284,474
Tissue Forceps Stille	72
Tissue Hook Frazier.....	112
Tissue Hook Sklar Release Pattern.....	113
Tissue Nipper.....	264
Titanium Phanco Knife Sklar Diamond™ ..	171
Titanium Step Knife Sklar Diamond™	171
Titanium Nitride Littauer Cutting Forceps ..	261
Tivnen Tonsil Seizing Forceps.....	202
Toe Nail Forceps Ingrown.....	265
Tongs Crutchfield.....	250
Tongue And Director Tie.....	121
Tongue Depressor Bosworth	197
Tongue Depressor Wieder.....	197
Tongue Seizing Forceps Collins	65,504
Tongue Seizing Forceps Young	65

Tonometer Schiotz.....	175
Tonometer Stand With Cover	175

TONSIL INSTRUMENTS

Tonsil Abraham Knife	199
Tonsil Forceps Colver-Coakley.....	202
Tonsil Forceps Sawtell.....	201
Tonsil Forceps Schnidt	201
Tonsil Forceps White	202
Tonsil Hurd Dissector And Pillar Retractor ..	200
Tonsil Knife Atkins	199
Tonsil Knife Canfield.....	199
Tonsil Knife Dean	199
Tonsil Knife Douglass	199
Tonsil Knife Fisher	199
Tonsil Knife Lothrop	199
Tonsil Punch Hartman (Mosher).....	200
Tonsil Punch Schmeden.....	200
Tonsil Scissors Boettcher	201
Tonsil Scissors Dean	201
Tonsil Seizing Forceps Craig.....	202
Tonsil Seizing Forceps Tivnen.....	202
Tonsil Seizing Forceps Tyding.....	202
Tonsil Snare Eves.....	198
Tonsil Tyding Knife	199
Tonsil Tyding Snare.....	198
Tooke Corneal Knife	136
Tourniquet N-I Automatic.....	255,287
Tourniquet Rumel	392
Towel Clamp Backhaus	87,207
Towel Clamp Hoff	87,207
Towel Clamp Jones Cross Action.....	87,207
Towel Clamp Laser Backhaus	368
Towel Clamp Roeder	87,207
Towel Clamp Sklar Cross Action	87
Towel Lorna (Edna) Clamp.....	87,207
Toynbee Ear Speculum	176
Tracheal Dilator Delaborde.....	204
Tracheal Hook News	205
Tracheal Retractor	111,205
Tracheal Retractor Hupp	111,205
Tracheal Retractor Jackson.....	111,205
Trachoma Forceps Prince	166
Traction Bow Bohler	254
Traction Forceps Lahey	65,334
Traction Handle Bill.....	372
Traction Lahey Forceps	383
Traditional Knife.....	457
Transplantation Forceps Platt Tendon.....	247
Tray, Double Deck Micro	507
Tray, Instrument Sterilizing	506
Tray, Mayo.....	508

Tray, Micro-Instrument Sterilizing	507
Tray Plastic Procedure	508
Trephines.....	145
Trephines, Castroviejo.....	145
Trephines, Elliot.....	145
Trocars.....	450
Trocar And Cannula.....	450
Trocar Duke Improved.....	118
Trocar Hassan	450
Trocar Hurwitz	118
Trocar Nelson	118
Trocar Ochsner.....	118
Trouble Shooting Guide for Instruments.....	515
Trousseau Tracheal Dilator	204
Troutman Blade Breaker.....	137
Troutman Needle Holder	168,492
Troutman-Barraquer Corneal	
Utility Forceps	154,487
Tru-Clips Michel.....	119
Trumpet Valve W/Coag. Suction Tube	447
Tube Adson Suction	117
Tube Baron Suction	117,492
Tube Buie Suction	117,297
Tube Coag. Suction W/Trumpet Valve	447
Tube Evacuation Sklar Blue™ Smoke.....	349
Tube Frazier Suction	117
Tube Holder Laser Smoke Evacuation	361
Tube Holder Sklar Blue™ Smoke Evac.....	349
Tube Irrigation/Suction.....	450
Tube Laser Smoke Evacuation.....	361
Tube Occluding Clamp	86
Tube Poole Suction	117
Tube Yankauer Suction	117
Tubing Disposable Smoke Evacuation	360
Tubing Forceps Marcuse	86
Tubing Forceps Non-Insulated	448
Tubing Forceps Sklar.....	86
Tubing Forceps St. Vincent	86
Tucker Hallux Forceps.....	240
Tuffier Rib Spreader	104,385
Tumor Grasping Forceps.....	478
Tuning Fork Aluminum Alloy Sklar.....	182
Turnbuckle Gerster (Lowman).....	236
Tuttle/Singley Forceps	73
Tuttle/Singley Laser Forceps	367
Tuttle/Singley Sklar Blue™ Forceps	357
Twister T-C Sklar Sternal Wire	433
Tyding Tonsil Knife	199
Tyding Tonsil Seizing Forceps.....	202
Tyding Tonsil Snare.....	198
Tying Bonn Forceps.....	489
Tying Forceps Bechert-McPherson	160,489

Tying Forceps Bonn.....	159
Tying Forceps Girard.....	160
Tying Forceps Harms.....	159
Tying Forceps Kelman-McPherson.....	160,489
Tying Forceps McPherson.....	159
Tying Forceps Tennant.....	160
Tyrell Iris Hook.....	112,140

U

Umbilical Scissors.....	29
Universal Style Biopsy Instruments.....	343
Unna Comedone Extractor.....	495
Urethral Dittel Sound.....	302
Urethral Sound Otis/Dittel.....	302
Urethral Sound Van Buren.....	301
U.S. Army Pattern Retractor.....	109
USA Pattern Gauze Scissors.....	28,259,290

UTERINE INSTRUMENTS

Uterine Clamp Buxton.....	65
Uterine Curette Greene.....	320
Uterine Curette Heaney.....	320
Uterine Curette Holden.....	319
Uterine Curettes Sims.....	321
Uterine Dilator Goodell.....	319
Uterine Dilator Hank.....	318
Uterine Dilator Pratt.....	318
Uterine Dilator Wylie.....	319
Uterine Forceps Delee.....	54,328
Uterine Hegar Dilator.....	318
Uterine Laufe Polyp Forceps.....	328,365
Uterine Polyp Forceps Laufe.....	54
Uterine Polyp Forceps Sklar Blue™ Laufe.....	357
Uterine Sims Sound.....	317
Uterine Skene Curette.....	320
Uterine Sound Malleable Simpson.....	317
Uterine Thomas Curettes.....	321
Uterine Wittner Biopsy Punch.....	342
Utility Commander Shears.....	257
Utility Corneal Forceps Troutman-Barraquer.....	154,487
Utility Forceps Colibri Corneal.....	154,487
Utility Forceps Girard Corneal.....	158
Utility Forceps McCullough.....	79
Utility Forceps Wills Hospital.....	161
Utility Hercules Scissors.....	257
Utility McCullough Forceps.....	161
Utility Nugent Forceps.....	161
Utility Scissors.....	18
Utility Scissors Hercules.....	292

Utility Scissors Multi-Cut.....	28,259
Utility Shears Commander.....	27,292
Utility Forceps Bonaccolto.....	161
Uvula Retractor Lothrop.....	204
Uvula Retractor Love.....	204

V

Vaginal Retractor Brantley-Turner.....	312
Vaginal Retractor Jackson.....	311
Vaginal Retr. Lat. Sklar Blue™ McGee.....	350
Vaginal Retractor McGee Lateral.....	309
Vaginal Retractor Pryer-Pean.....	312
Vaginal Retractor Sims.....	311
Vaginal Retractor Sklar Blue™ Jackson.....	353
Vaginal Retractor Sklar Blue™ Lateral.....	350
Vaginal Retractor Sklar Lateral.....	309
Vaginal Spatula Segond.....	312
Vaginal Speculum, Auvarud Laser.....	361
Vaginal Speculum, Auvarud Weighted.....	310
Vaginal Speculum, Collin.....	308
Vaginal Speculum, Collin Laser.....	361
Vaginal Speculum, Cusco.....	309
Vaginal Speculum, Devilbiss.....	309
Vaginal Speculum, Freeway Graves.....	307
Vaginal Speculum, Garrigue Weighted.....	310
Vaginal Speculum, Graves.....	307
Vaginal Speculum, Graves Laser.....	360
Vaginal Spec., Graves Wide View Pat.....	307
Vaginal Speculum, Gutmann.....	309
Vaginal Speculum, Henrotin Weighted.....	310
Vaginal Spec., Laser Freeway Graves.....	360
Vaginal Speculum, Laser Graves.....	358
Vaginal Speculum, Laser Lateral.....	361
Vaginal Speculum, Laser Pederson.....	358,360
Vaginal Speculum, Laser Steiner-Auvarud.....	361
Vaginal Speculum, Pederson.....	308
Vaginal Speculum, Pederson Laser.....	359
Vaginal Speculum, Pederson Sklar Blue™.....	347
Vaginal Speculum, Sklar Blue™ Graves.....	346
Vaginal Speculum, Sklar Blue™ Collin.....	350
Vaginal Speculum, Sklar Blue™ Freeway.....	349
Vaginal Speculum, Sklar Blue™ Freeway Graves.....	349
Vaginal Speculum, Sklar Blue™ Graves Wide View.....	349
Vaginal Speculum, Sklar Blue™ Pederson.....	348
Vaginal Speculum, Sklar Blue™ Steiner-Auvarud.....	351

Steiner-Auvarud Weighted.....	310
Vaginal Speculum, Steiner-Sklar Weighted.....	310
Vaginal Tauber Spatula.....	312
Vaginal Wide View Spec. Laser Graves.....	360
Valve Retractors Cooley Atrial.....	433
Valve Trumpet W/Coag. Suction Tube.....	447
Van Bruen Sequestrum Forceps.....	239
Van Buren Plaster Forceps.....	258
Van Buren Urethral Sound.....	301
Vanderbilt University Forceps.....	378
Vanguard Splinter Pick.....	81,493
Vannas Scissors.....	151
Vannas Spring Handle Scissors.....	31,151,484
Varco Forceps.....	49
Varco Gall Bladder Forceps.....	124
Vascular Clamp Approximators.....	476
Vascular Clamp Non-Approx. W/Frame.....	477
Vascular Clamp DeBaKey Peripheral.....	397
Vascular Cooley Forceps.....	422
Vascular Cooley Tissue Forceps.....	426
Vascular DeBaKey Atraumatic Forceps.....	396
Vascular DeBaKey Clamp.....	403
Vascular DeBaKey Scissors.....	430
Vascular DeBaKey Scissors.....	431
Vascular Dilators Short.....	428
Vascular Forceps DeBaKey Bainbridge.....	400
Vascular Lemmon Needle Holder.....	395
Vascular Neonatal Clamp Cooley.....	426
Vascular Scissors Favaloro.....	431
Vascular Scissors Spring Handle.....	429
Vascular Single Clamp.....	475
Vascular Strelli Forceps.....	432
Vascular Thrombectomy Spatula.....	432
Vascular Tissue Forceps Cooley.....	394
Vascular Tissue Forceps DeBaKey Atraumatic.....	395
Vasectomy Clamp Textor.....	303
Vein Retractor Cushing.....	106
Vena Cava Clamp Satinsky.....	405
Verbrugge Bone Holding Forceps.....	238
Veress Needle.....	450
Verucca Curette.....	266
Vessel And Nerve Retractor.....	433
Vessel Dilator.....	483
Vessel Forceps DeBaKey Atraumatic Peripheral.....	397,400
Vet Scissors.....	22
Vienna Nasal Speculum.....	185
View Wide Laser Graves Vaginal Spec.....	360
Virtus Splinter Forceps.....	494
Vogel Adenoid Curette.....	203



Volkman Bone Hook.....	241
Volkman Retractor (Ring Handle).....	105
Volkman Curette.....	236,280
Von Graefe Cystotome.....	136
Von Graefe Iris Forceps.....	155
Von Graefe Knife Needle.....	134
Vulsellum Doyen Forceps.....	331
Vulsellum Forceps Doyen.....	55
Vulsellum Forceps Henrotin.....	55
Vulsellum Forceps Jacobs.....	55,333
Vulsellum Forceps Schroeder.....	60,332,333
Vulsellum Forceps Teale.....	60,327,331
Vulvar/Dermal Punch Keyes.....	317

W

Wachenfeldt Clip Forceps.....	83,120
Wachenfeldt Wound Clips.....	120
Wagner Scissors.....	8
Wagner Scissors Sklarcut™.....	32
Wagner Scissors Sklarlite™ Sklarcut™.....	32,467
Waldeau Fixation Forceps.....	157
Walther Dilator-Catheters.....	316
Walton Plaster Spreader.....	259,1291
Walton Suture Forceps.....	160
Wand Clamp Laser.....	360
Wand Clamp Sklar Blue™.....	349
Wangensteen NHolder T-C Sklargrip™.....	93
Wartenberg Neurological Pinwheel.....	497
Weber Aortic Clamp.....	410
Webster Needle Holder.....	88,324
Webster Needle Holder Sklargrip™ T-C.....	92
Webster Needle Holder T-C.....	94
Weeks Eye Speculum.....	130
Weighted Vaginal Speculum Auvard.....	310
Weighted Vaginal Spec. Berliand-Auvard.....	310
Weighted Vaginal Speculum Garrigue.....	310
Weighted Vaginal Speculum Henrotin.....	310
Weighted Vaginal Spec. Steiner-Auvard.....	310
Weighted Vaginal Speculum Steiner-Sklar.....	310
Weingartner Ear Forceps.....	180
Weinstein Instrument Rack.....	505
Weis Chalazion Forceps.....	166
Weisenbach Forceps Holder.....	505
Weisman Infant Ear Cutette.....	177
Weitlaner Self-Retaining Retractor.....	100
Wertheim-Cullen Pedicle Clamp.....	52,127
Wesson Mouth Gag.....	197
West Blunt Dissector.....	246
West Bone Gouge.....	195
Westcott Scissors.....	31,147,485
Weston Rectal Snare.....	297

Wheeler Discission Knife.....	134
White Forceps.....	64
White Tonsil Forceps.....	202
Wide Bite Mini Tischler Delicate Punch.....	336
Wide Bite Sklar Oval Biopsy Punch.....	338
Wide Bite Sklar Tisch. Oval Biopsy Punch.....	337
Wide View Pattern Graves Vag. Spec.....	307
Wide View Sklar Blue™ Grvs. Vag. Spec.....	349
Wide View Vaginal Spec. Laser Graves.....	360
Width And Laser Depth Rulers.....	365
Wieder Tongue Depressor.....	197
Wiener Eye Speculum.....	128
Wiener Scleral Hook.....	140
Wigmore Plaster Saw.....	256
Wilde Ear Forceps.....	76,180
Wilde Intervertebral Disc Rongeur.....	223
Wilde Nasal Forceps.....	187
Wilder Cystotome.....	136
Wilder Lachrymal Dilator.....	144
Wilder Lacrimal Sac Retractor.....	133
Wilder Lens Loop.....	139
Williams (Stieglitz) Splinter Forceps.....	494
Williams Bayonet Perforator.....	181
Williams Lachrymal Dilators.....	144
Williams Speculum.....	130
Williger Bone Curette.....	236
Wills Hospital Utility Forceps.....	161
Wilmer Iris Scissors.....	22
Wilmer Scissors.....	152,485
Wilson Rib Spreader.....	104,386
Wire And Pin Cutter T-C.....	251
Wire Barraquer Speculum.....	128
Wire Cutting Scissors Sklar Edge™ T-C.....	35
Wire Cutting Scissors Suture.....	23,28,119,251
Wire Extractor/Snap Lock Pin.....	288,289
Wire Eye Speculum Kratz-Barraquer.....	128
Wire Guide Borchard.....	253
Wire K-Driver.....	286
Wire Kirschner.....	255
Wire Knot Tightener Harris.....	253
Wire Plain Speculum.....	129
Wire Pliers Extraction Double Action T-C.....	288
Wire Puller T-C.....	252
Wire Retaining Retractor.....	101
Wire Speculum Barraquer.....	128
Wire Stainless Suture.....	120,290
Wire Twister T-C Sklar Sternal.....	433
Wires Cut & Bent Snare.....	198
Wires Kirschner.....	286
Wittner Uterine Biopsy Punch.....	342
Wolfe-Biehler Plaster Cast Breaker.....	258,291
Wound Clips Wachenfeldt.....	120
Wound Forceps James.....	283

Wound Forceps King.....	283
Wylie Uterine Dilator.....	319

Y

Yankauer Suction Tube.....	117
Yeoman Sklar Rectal Biopsy Punch.....	297
Young Anterior Retractor.....	107
Young Bifurcated Retractor.....	107
Young Lateral Retractor.....	107
Young Prostatic Retractor.....	304
Young Tongue Seizing Forceps.....	65

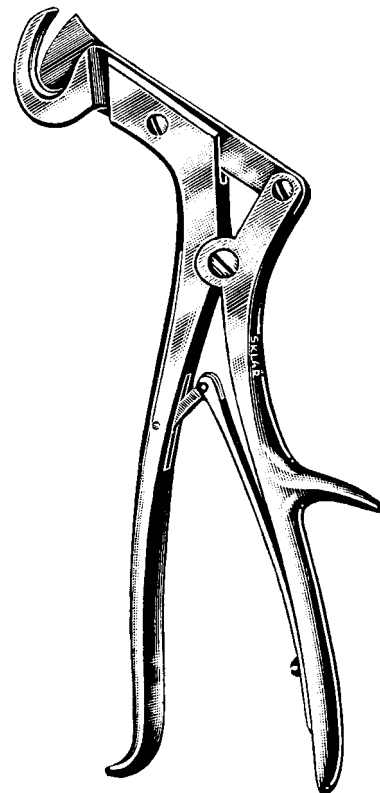
Z

Zalkind Lung Retractor.....	108,389
Zalkind (Ribbon) Retractor.....	108
Zaufel-Jansen Rongeur.....	214,277
Zeigler Cilia Forceps.....	82,163
Zeigler Knife-Needle.....	136
Zeigler Lachrymal Dilator.....	144
Zeigler Speculum.....	129
Zielke Intervertebral Rongeur.....	223

NEW!

SKLAR CUSTOM SERVICES, INC.

*Sklar Will Utilize Its
100 Years Of
Experience To
Solve Your Unique
Instrument
Problems!*



Sklar's Custom Service Team is dedicated to providing solutions to your instrument problems.

Sklar proudly announces the formation of a new division, Sklar Custom Services, Inc., to meet your needs.

100 years of research design and manufacturing of quality surgical instruments has provided Sklar with unparalleled experience and technical know-how in all facets of hand held surgical instruments!

Call us For:

- Sklar Blue™ Electrosurgery coatings
- Sklar Laser™ coatings
- Hard-to-find instruments
- Discontinued instrument patterns
- Design and modification of surgical instruments to custom specifications



Contact: Sklar Custom Services • Telephone: 800-822-0124 • Fax: 610-429-0500



Sklar Repairs and Restores Instruments To Original Quality In Only 48 Hours

In today's cost-conscious environment, the medical community is looking for ways to prolong instrument life and minimize the impact of new instrument purchases.

Our highly trained and experienced craftsmen have been performing surgical instrument repairs for decades, elevating their skills and attention to details to a fine art.

All component parts are cleaned, repaired or replaced. The instrument is then precision aligned and adjusted to exacting specifications using the latest technologies. In addition, the tool is lubricated and polished to its original condition.

Sklar craftsmen are capable of repairing any brand of instrument and Sklar backs the quality of the work with a solid warranty. However, Sklar instruments are only authorized for repair by Sklar's own repair service personnel.

SKLAR INSTRUMENT RESTORATION SERVICE returns all your surgical instrumentation to absolutely perfect condition within 48 hours.

For personal service, FREE estimates and pricing call: (610) 430-3209. Return shipment by Federal Express at your request.

***For the price of a repair, Sklar will
restore your instrument to the original
new condition in 48 hours.***



*Overnight Delivery
Available at Your
Request*

Sklar Lifetime Warranty

*Sklar Has The
Highest Quality Standards
In The Industry!*

All Sklar Instruments are guaranteed for life against manufacturing defects, provided the instrument is used for its intended surgical purpose. Sklar will either repair or replace the instrument without charge at our discretion*. Our guarantee is unqualified because Sklar Instruments are checked by our own quality control inspectors.



Our instruments are carefully examined in the factory. Also, our instrument experts inspect every instrument using a 51-point checklist for all incoming instruments and a six-point final checklist on EVERY item shipped.



Any instrument not meeting our stringent quality standards is polished, cleaned or fine-tuned in our own workshop. No instrument is shipped unless it meets our standards.

*Tungsten carbide instruments are included except for jaw inserts or coated jaws which are covered by a separate warranty.