



COVID-19 TEST™



Scan with your
smartphone to
watch our helpful
How-To-Test video

3EOHealth.com/test

Text "TEST" to (205) 973-2550



INSTRUCTIONS FOR USE

For use under an Emergency Use Authorization (EUA) only.

For in vitro diagnostic use.

For over the counter (OTC) use.

For use by Individuals with signs and symptoms of Respiratory
Tract Infection

TABLE OF CONTENTS

Intended Use	p. 3
Reporting Results	P. 5
Summary and Explanation	p. 6
Principles of The Procedure	p. 7
Precautions	p. 10
Warning Notices	p. 12
Test Preparation and Operation	p. 13
Precautions: Nasal Sample Collection	p. 14
Storage Conditions	p. 15
Introduction	p. 16
Watch the How-To-Test Video	p. 17
Scan QR Code To Watch Video	p. 18
Test Items Overview	p. 19
Prepare To Test	p. 20
Remove Key From Packaging	p. 21
STEP 1: Activate Key	p. 22
STEP 2: Insert Key	p. 23
STEP 3: Swab Both Nostrils	p. 24
STEP 4: Remove Cover From Swab	p. 25
STEP 5: Insert Swab Into Key	p. 26
STEP 6: Start the Test	p. 27
STEP 7: Get Test Result	p. 28
Positive Result	p. 29
Negative Result	P. 30
When To Retest	p. 31
Test Disposal	p. 32
Limitations	p. 33
Test Performance	p. 35
Cleaning Your Cube	p. 46
Troubleshooting	p. 47
Frequently Asked Questions	P. 48
Technical Information	p. 50
Cube Disposal	p. 54
Symbols	p. 55
Customer Support	p. 56

INTENDED USE

The 3EO Health COVID-19 Test is a single-use molecular in vitro diagnostic test intended for the qualitative detection of SARS-CoV-2 nucleic acid directly in anterior nasal swab specimens from individuals with signs and symptoms of COVID-19 (i.e., symptomatic). This test is authorized for non-prescription home use with self-collected anterior nasal (nares) swab samples from individuals aged 14 years or older or adult-collected anterior nasal (nares) swab samples from individuals aged two years or older.

This test utilizes nucleic acid amplification technology, similar to PCR, for the detection of SARS-CoV-2 RNA, which is generally detectable in anterior nasal swab samples during the acute phase of infection.

Positive results indicate the presence of SARS-CoV-2 RNA, but clinical correlation with past medical history and other diagnostic information is necessary to determine infection status. Positive results do not rule out bacterial infection or co-infection with other viruses. The agent detected may not be the definitive cause of disease. Individuals who test positive with the 3EO Health COVID-19 Test should self-isolate and seek follow-up care with their physician or healthcare provider as additional testing may be necessary.

Continued on next page >

INTENDED USE

Negative results do not preclude SARS-CoV-2 infection and should not be used as the sole basis for treatment or management decisions for the individual, including infection control measures such as isolating from others and wearing masks. Negative results should be considered in the context of an individual's recent exposures, history, and the presence of clinical signs and symptoms consistent with COVID-19. Individuals who test negative and continue to experience COVID-19-like symptoms of fever, cough, and/or shortness of breath may still have SARS-CoV-2 infection and should seek follow-up care with their physician or healthcare provider.

Individuals should provide all results obtained with this product to their healthcare provider for public health reporting and to receive appropriate healthcare. All healthcare providers will report all test results they receive from individuals who use the authorized product to relevant public health authorities in accordance with local, state, and federal requirements using appropriate LOINC and SNOMED codes, as defined by the Laboratory In Vitro Diagnostics (LIVD) Test Code Mapping for SARS-CoV-2 Tests provided by the CDC.

The 3EO Health COVID-19 Test is only for use under the Food and Drug Administration's Emergency Use Authorization.

REPORTING RESULTS

It is important to consult your healthcare provider to discuss your results and whether additional testing is necessary.

Test results should be reported to:

<https://makemytestcount.com>

Read and download the Instructions for Use, Fact Sheet for Patients and Fact Sheet For Healthcare Providers at <https://3EOhealth.com/test>

SUMMARY AND EXPLANATION

The 3EO Health COVID-19 Test™ is an *in-vitro* diagnostic molecular test for the qualitative detection of SARS-CoV-2 virus that causes the COVID-19 disease in anterior nasal swab specimens from individuals with signs and symptoms of COVID-19 (i.e., symptomatic).

Samples from anterior nasal swabs are analyzed and results are available within approximately 30 minutes. Each 3EO Health COVID-19 Test Kit™ contains all components necessary to test for SARS-CoV-2.

PRINCIPLES OF THE PROCEDURE

The 3EO Health COVID-19 Test™ utilizes 3 components to detect SARS-CoV-2 RNA at home: the reusable 3EO Cube, the one-time-use 3EO Key and the 3EO anterior nasal (AN) Swab.

The user first opens a 3EO Key from the foil pouch, activates it and inserts it into the Cube. The user next blows their nose to clear excess mucus, then collects an anterior nasal sample with the 3EO Swab. The user then removes the swab guard and fully inserts the Swab into the Key that sits within the Cube. The user then starts the test by pressing the green start button. All further steps are automated. A result is indicated on the Cube within approximately 30 minutes.

The test uses a combination of reverse transcription, loop-mediated isothermal DNA amplification (RT-LAMP) and sequence-specific probe technologies to detect segments of the SARS-CoV-2 RNA genome.

Continued on next page >

PRINCIPLES OF THE PROCEDURE

The anterior nasal sample is automatically eluted within the Key. The Cube then mixes the sample buffer with a freeze-dried bead containing all biochemistry, and heats the reaction. RNA from three (3) SARS-CoV-2 target sequences (ORF1a, E, and S) is copied into DNA, amplified, and converted into fluorescent signals.

Additionally, use of a naturally occurring human gene as a parallel target with a different fluorescent output serves to affirm the reaction steps, including successful sample acquisition, elution, management of chemical inhibitors in the sample, amplification, fluorescence generation, data acquisition, and execution of the diagnostic algorithm. No streptavidin/biotin chemistry is used, and all samples and biochemistry remain locked within the one-time-use Key.

Detection of one or more SARS-CoV-2 sequences returns a positive result regardless of control detection, but a negative result on both SARS-CoV-2 and control causes an “invalid” result to be indicated.

Continued on next page >

PRINCIPLES OF THE PROCEDURE

- Follow directions for use
 - Do not ingest
 - Keep out of reach of children
 - Avoid contact with skin and eyes
 - If contact with the body occurs, rinse with water. If irritation persists, seek medical advice.
- The 3EO Health COVID-19 Test™ is to be used in the 3EO Health Navigation System™, which consists of the 3EO Cube, the 3EO Key, and the 3EO Swab.
- Store and use the Key within the below temperature ranges:
 - Storage: between 59°F (15°C) and 86°F (30°C)
 - Use: between 59°F (15°C) to 86°F (30°C)
- Refrigeration is not required.

PRECAUTIONS

- For use under an Emergency Use Authorization (EUA) only. This product has not been FDA cleared or approved but has been authorized by the FDA under an Emergency Use Authorization (EUA) for OTC use.
- For *in vitro* diagnostic use.
- This product has been authorized only for the detection of nucleic acid from SARS-CoV-2, not for any other viruses or pathogens.
- The emergency use of this product is only authorized for the duration of the declaration that circumstances exist justifying the authorization of emergency use of *in vitro* diagnostics for detection and/or diagnosis of COVID-19 under Section 564(b)(1) of the Federal Food, Drug and Cosmetic Act, 21 U.S.C. § 360bbb-3(b)(1), unless the declaration is terminated or authorization is revoked sooner.





Continued on next page >

PRECAUTIONS

- The 3EO Cube has been tested and shown to comply with applicable Electromagnetic Compatibility (EMC) standards. However, portable RF communications equipment (including peripherals such as antenna cables and external antennas) should be used no closer than 30cm (12 Inches) to any part of the Cube including its power cable. Otherwise, degradation of the performance of the Cube could result.
- Use of this equipment adjacent to or stacked with other equipment should be avoided because it could result in improper operation. If such use is necessary, this equipment and the other equipment should be observed to verify they are operating normally.

WARNINGS AND NOTICES

The following warnings and notices are used in this document:

Symbol	Type	Description
	Note	This type of notice highlights important information in a procedure. Failure to comply with the notice may result in invalid test results and/or require repetition of procedure steps.
	Caution	This type of notice provides information about potential hazards to the 3EO Cube. Failure to comply with the notice may result in damage to the Cube.
	Warning	This type of notice provides information about potential hazards to the user. Failure to comply with the notice may result in injury or harm to the user.
	STOP	This type of notice provides information about potential missteps by the user. Failure to comply with the notice may result in a test error, invalid result, false positive or false negative.

TEST PREPARATION AND OPERATION

- **Do not use the 3EO Key past the expiration date, which can be found on the test box and pouch labels.**
- Children aged 2 to 13 years of age should be tested by an adult.
- Do not use on anyone under 2 years of age.
- To ensure correct results, you must follow the instructions for use.
- Do not insert anything other than a 3EO Key into the Cube.
- Do not use if packaging is opened or damaged before use.
- Do not use any components with visible damage.
- Do not open the sealed Key and Swab pouches until immediately before use.
- Do not use sharp objects to open the Key and Swab pouches as damage to the contents can occur.
- Only anterior nasal samples collected with the 3EO Swab can be used for the test.
- Nasal sprays, gels, or cream should not be used before collecting a sample.
- Avoid eating or drinking 30 minutes prior or smoking 60 minutes prior to specimen collection.
- **Nostrils should be cleared of excess mucus and other debris by blowing nose before sampling.** The nasal swab is designed to only collect the correct amount of sample volume required for the test.
- Both nostrils must be swabbed and the Swab must be inserted into the Key immediately.
- Risks of sample collection include irritation, bleeding, and infection inside the nose.
- Test completion occurs in approximately 30 minutes, during which no attention to the device is required.
- Key and Swab are one-time use items.

PRECAUTIONS: NASAL SAMPLE COLLECTION

When running a test for a patient, consider the following:

- If being used in a laboratory setting, treat all biological specimens as if capable of transmitting infectious agents. Wear clean lab coats and gloves. Change gloves between patients.
- Follow safety procedures set by your institution for handling biological specimens.
- The Swab is not designed to be transported. Perform Swab collection within the vicinity of the Cube.
- Do not remove the Swab Guard before collecting a nasal sample. Doing so could lead to false results.
- **Insert the Swab into the Key immediately after sample collection.** Not doing so could lead to false results.
- Do not move or tilt the Cube during operation. Doing so could lead to false results.
- Failure to activate the 3EO Key as instructed in Step 1 can lead to false results.
- Do not place the 3EO Cube in direct sunlight.

STORAGE CONDITIONS

Store unopened 3EO Health COVID-19 Tests™ at room temperature, between 59°F (15°C) and 86°F (30°C). Dispose of if stored outside of this range.

INTRODUCTION

These instructions for use will help you navigate the simple steps of the 3EO testing experience.

Please follow each step in this guide carefully to ensure testing success.

Before you start testing, please watch the helpful how-to-test video in its entirety. If you are unable to watch the video, please turn to page 19 to continue.

When you are ready to begin the test, please follow these instructions carefully, step by step.

While following these instructions, please pay close attention to the stop warnings - they are there to help ensure you don't miss critical steps in the 3EO testing process.

Look for:



3EOHealth.com/test

This QR Code to watch our helpful How-To-Test video



This STOP warning which asks you to double check important steps

WATCH THE HOW-TO-TEST VIDEO



Use one of the methods below to watch our helpful How-To-Test video in its entirety **BEFORE** you begin testing.

We know you are eager to dive in and get started! Before you do, use one of the methods below to watch our helpful video **before** you start to test.

If you are unable to watch the video, turn to page 18 to continue.

[Go to 3EOhealth.com/test](https://3EOhealth.com/test)

OR

Text **“TEST”** to **(205) 973-2550**
to receive a one-time text with a link to watch the video

OR

Scan the QR code on the following page

WATCH THE HOW-TO-TEST VIDEO 17

SCAN QR CODE TO WATCH VIDEO

- A** Open the camera app on your mobile phone
- B** Hold the camera directly in front of the QR code
- C** Your camera will “read” the QR code – you won’t take a picture
- D** Tap the “qr.go3eo.com” link that appears on your screen
- E** You will be brought to our video located at:
3EOhealth.com/test

*****If you are unable to watch the video, turn to the next page to continue.***



3EOHealth.com/test



TEST ITEMS OVERVIEW

Your 3EO test has three items that you will use to complete your test. Below are the important details to help you become familiar before you test.

Don't worry - you won't have to remember these details! We will remind you later, at the correct step on the following pages.



**Do not not use the test kit
beyond the expiration date.**



**DO NOT OPEN Key or Swab pouches until your
instructions tell you to do so at the correct step.**

3EO Cube

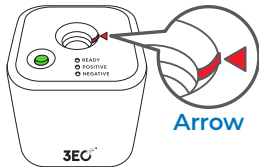

- ▶ Place on clear, clean, flat surface
- ▶ Needs to be plugged in to operate
- ▶ Power adapter is included

3EO Key

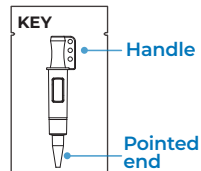

- ▶ Once you take the Key out of the pouch, you will hold the Key by its handle (p. 21)
- ▶ You will then activate the Key (p. 22)
- ▶ Once activated, you will plug the Key into the Cube (p. 23)

3EO Swab

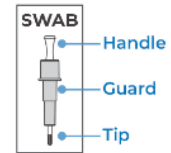

- ▶ You will hold the Swab by its handle (p. 24)
- ▶ Remove the swab guard only after swabbing (p. 25)
- ▶ Insert the Swab into top of Key **immediately** after sample collection and removing the Swab Guard (p. 26)

PREPARE TO TEST

- Wash or sanitize your hands before and after testing.
- Before testing, choose a location where your Cube can sit on a clear, clean, flat surface undisturbed for approximately 30 minutes.
- Read all instructions in this manual and the supplied Quick Start Guide carefully before beginning your test.
- Place the Cube on a clean, clear, and flat surface. Plug in. All three lights will illuminate and remain illuminated when properly plugged in, indicating the Cube is ready to use.

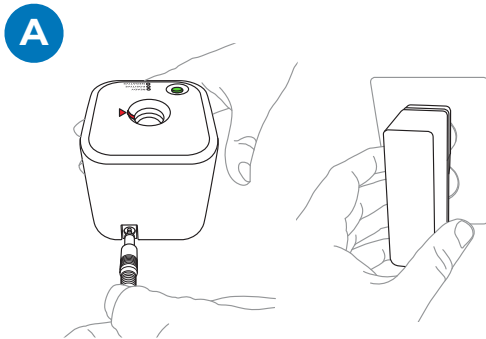

- Plug Cube in.
- All lights will come on.

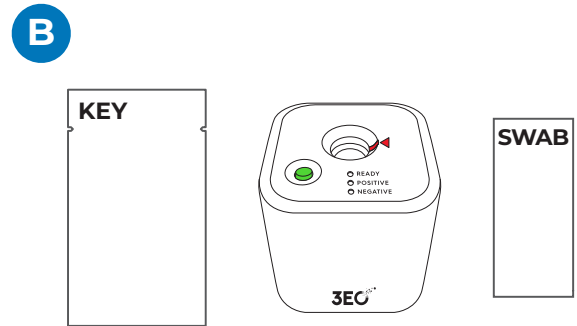

- Place Key and Swab pouches next to Cube.
- Put the Quick Start Guide flat in front of you.



You must run the 3EO Health COVID-19 Test™ at room temperature (between 59°F (15°C) to 86°F (30°C))

REMOVE KEY FROM PACKAGING WHEN READY TO BEGIN TESTING

A

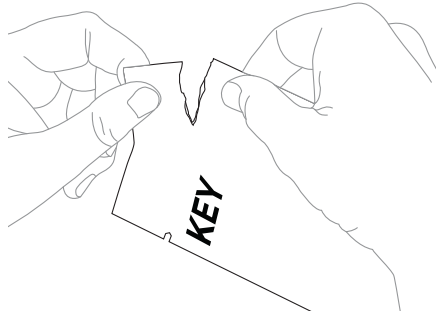

- Tear open Key pouch to remove Key.

B

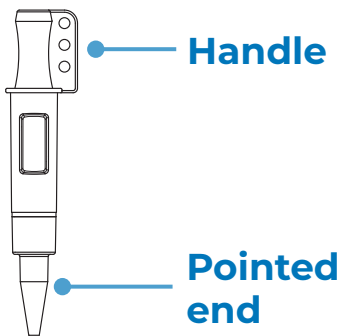

- Remove Key from pouch, holding Key by its handle.

STEP 1: ACTIVATE KEY

Be sure to wash or sanitize your hands before and after testing.

There is fluid inside the Key. This step helps to ensure proper liquid placement.

To activate Key:

- Hold Key with pointed end facing away from you.
- Swing arm quickly with force down one time only.
- Do not swing arm back up.
- Keep Key pointed down.
- Do not shake Key.

A

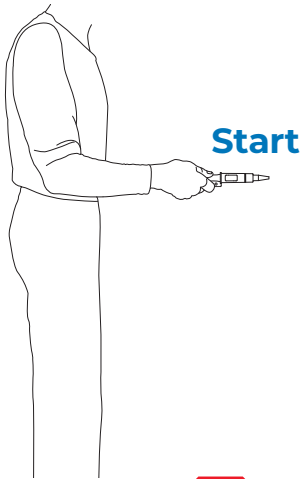

B

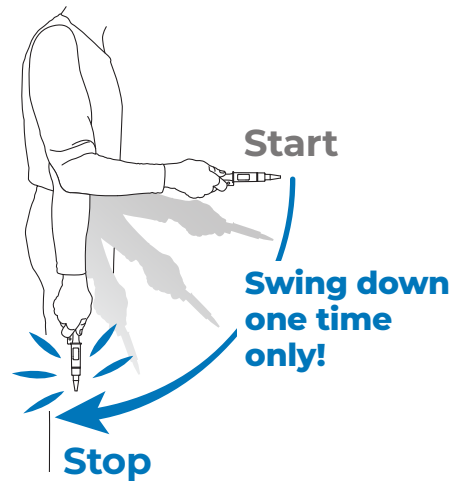

Are you keeping your Key pointed down?

ACTIVATE KEY 22

STEP 2: INSERT KEY

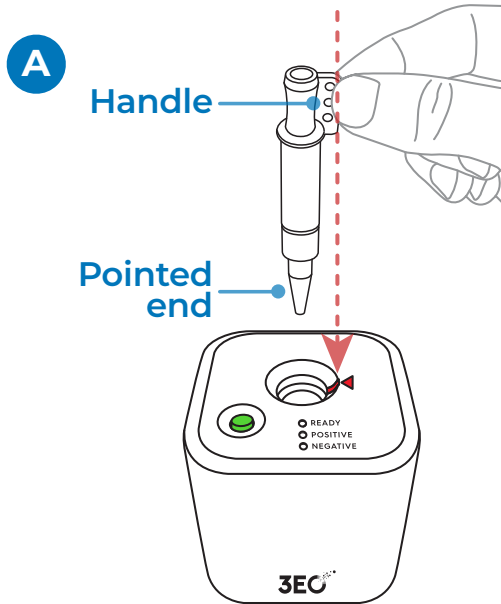

- Keep the pointed end of the Key down.
- Line up the handle with the arrow on the Cube.
- Insert the pointed end of the Key into the hole in the Cube.

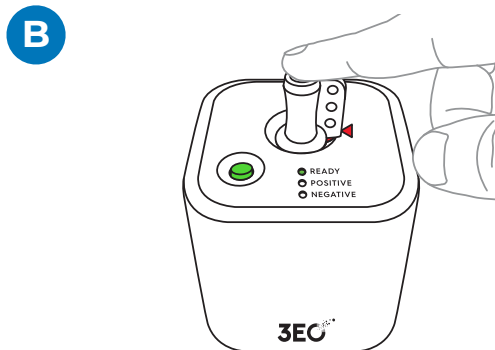

- Push the Key down firmly until only the READY light glows steady **GREEN**.



If READY light does not glow steady GREEN, check that the Key is inserted fully into the Cube.

STEP 3: SWAB BOTH NOSTRILS

Blow your nose before swabbing to clear excess mucus

A

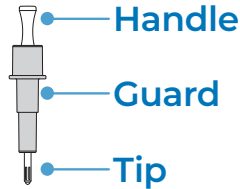

- Peel pouch to remove 3EO Swab.
- Remove Swab, holding upright by its handle.
- **Do not touch Swab to any surface.**

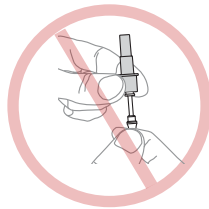

- **Do not remove swab guard** - you will remove it **after** swabbing.
- Hold swab upright by its handle only.
- Be sure tip of swab is visible and fingers are not touching guard.
- Insert Swab 3/4 of an inch in each nostril (1/2 inch if swabbing a child).
- Do not exert excessive force when swabbing or insert the swab beyond the recommended depth.
- Do **5 circles** around the wall of **each nostril**.
- **Make sure Swab tip touches inside walls of nose.**

B

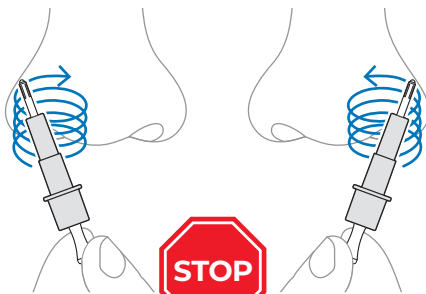

STOP

Did you
swab both
nostrils?

STEP 4: REMOVE GUARD FROM SWAB

A

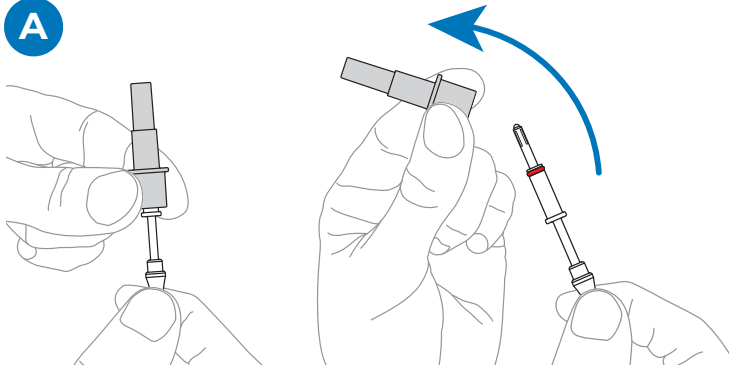

Remove guard from Swab.

Discard guard.

B

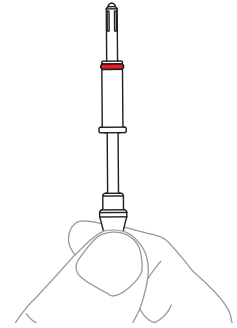

Continue to **hold Swab by handle.**



- ▶ Do not set the Swab down or allow the Swab tip to come in contact with other surfaces before or after you swab your nose.
- ▶ For this test to work properly, you must swab both nostrils.
- ▶ The Swab is designed to measure and collect a small amount of sample. Do not attempt to collect excess mucus or excessively scrape the wall of your nose.

STEP 5: INSERT SWAB INTO KEY IMMEDIATELY

A

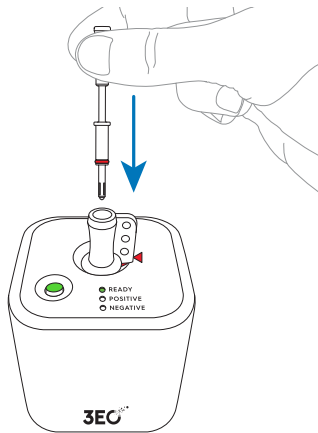

- Insert the Swab into top of Key **immediately** after sample collection and removing the Swab Guard.
- **Do not attempt to insert a Swab that still has the Guard attached.**

B

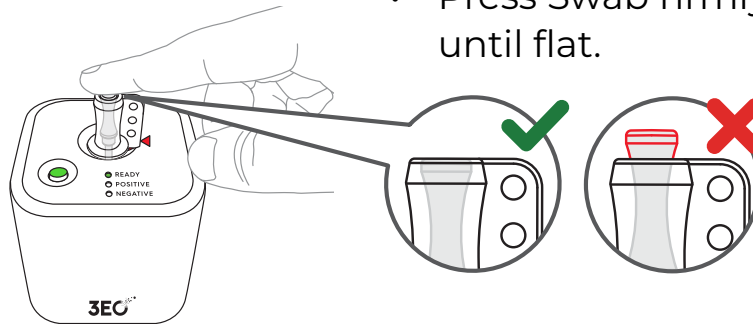

- Press Swab firmly down until flat.

C

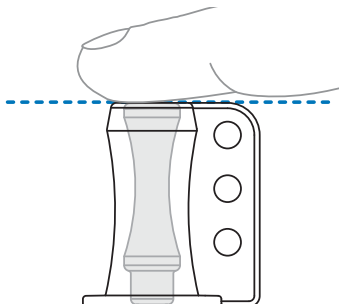

- Ensure Swab is even with top of Key.



Did you push the Swab down flat?

STEP 6: START THE TEST

A

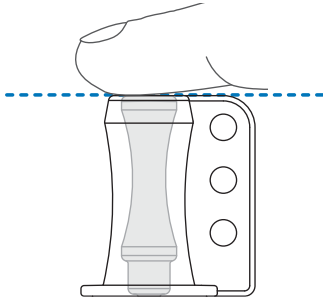

- Double-check to make sure top of Swab is flat and even with top of Key.

B



- Press and hold **GREEN** button until the READY light starts flashing.
- If READY light does not begin flashing, press and hold **GREEN** button again.

- ▶ If you forget to press the GREEN button within 60 minutes of inserting the Swab into the Key, you will need to retest. Remove the Key and Swab from the Cube. Start a new test with a new Key and a new Swab.



- ▶ Do not attempt to remove the Key once you have pressed the Start button, your test may be invalid.
- ▶ Do not move or tilt the Cube during operation. Doing so could lead to false results.
- ▶ If all three lights blink after pressing the GREEN button, your test has encountered a Test Error. If this occurs, see page 31.

STEP 7: GET TEST RESULT

- **Your test will take approximately 30 minutes to display a result.**
- The **GREEN** READY light will continue flashing until your result is ready.
- Your result, when ready, will be displayed via a steady light on the top of the Cube.
- If you have waited more than 35 minutes and there are lights flashing on top of the Cube, you will need to retest. Go to page 31 to continue.

POSITIVE RESULT:

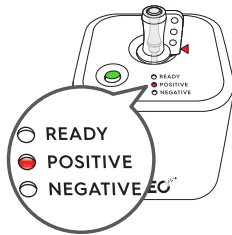

Steady **RED**
light next to
POSITIVE

NEGATIVE RESULT:

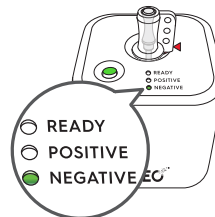

Steady **GREEN**
light next to
NEGATIVE



- ▶ The test will require no attention during operation.
- ▶ Upon completion, results are displayed by colored light indicators.
- ▶ The Cube will continue to display the test result indefinitely while the Key remains inserted. Once the Key is removed, the result of the last test will display for 15 minutes or until a new Key is inserted for the next test. Once a new Key is inserted into the Cube, the Cube is ready for the next test.

POSITIVE RESULT

- It is very likely you have COVID-19 and it is important to be under the care of a healthcare provider. A positive result means that SARS-CoV-2, the virus that causes COVID-19, has been detected in your sample. This typically indicates an active, infectious virus in the user.
- Consult your healthcare provider for treatment.
- Those with difficulty breathing or other serious symptoms should seek emergency care immediately. Your healthcare provider will work with you to determine how best to care for you based on your test results along with medical history and your symptoms.

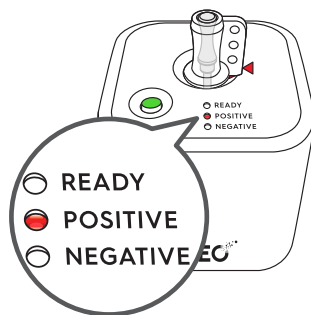

POSITIVE RESULT:

Steady **RED** light next to POSITIVE

Test results should be reported to:
<https://makemytestcount.com>

NEGATIVE RESULT

- A Negative Result means that SARS-CoV-2, the virus that causes COVID-19, was not detected in your sample.
- Negative results should be taken within the contexts of possible exposure and symptoms. A negative result in no way indicates the absence of other respiratory or non-respiratory viruses or other infections.
- It is possible for this test to give a negative result that is incorrect (a false negative) in some people with COVID-19. This means you could possibly still have COVID-19 even though the test is negative. Your healthcare provider will consider your overall health and history to decide how to care for you.
- It is important you work with your healthcare provider to help you understand the next steps you should take.

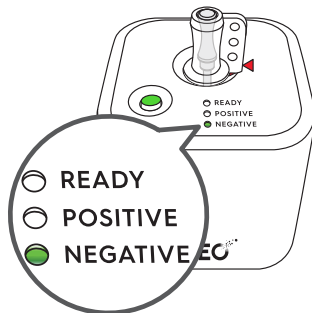

● **NEGATIVE RESULT:**

Steady **GREEN** light next to **NEGATIVE**

Test results should be reported to:
<https://makemytestcount.com>

WHEN TO RETEST

- Results are displayed via lights at the top of the Cube.
- If both of the Positive and Negative lights flash, your test is invalid and must be repeated. Unplug the Cube and plug back in. Remove the Key from the Cube. Start a new test with a new Key and Swab, or seek testing by an alternative method.
- If, at any time, all lights flash, there has been a testing error. Unplug the Cube and plug back in. Remove the Key from the Cube. Start a new test with a new Key and Swab, or seek testing by an alternative method.

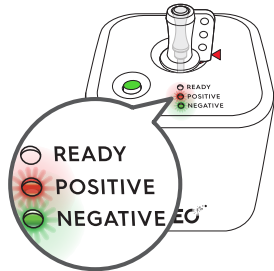

BOTH RED (POSITIVE) AND GREEN (NEGATIVE) LIGHTS FLASH:

- Test is invalid and must be repeated
- Unplug Cube and plug back in
- Remove Key from Cube
- Start a new test with a new Key and Swab

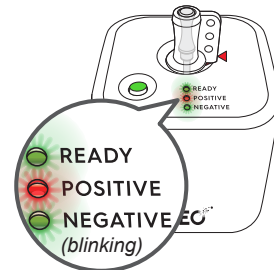

ALL LIGHTS FLASH:

- Test has an error and must be repeated
- Unplug Cube and plug back in
- Remove Key from Cube
- Start a new test with a new Key and Swab

TEST DISPOSAL

- After the test is complete, remove the used Key with the contained Swab. Dispose of in a household trash can or per local regulation.
- Care must be taken in disposing of the Key and Swab to not contaminate other surfaces with samples or internal components, for example by forcing open or breaking the Key. Treat all biological samples as capable of transmitting infectious agents.
- The Cube should be cleaned after each use to prevent cross-contamination between users. See page 47 for cleaning instructions.

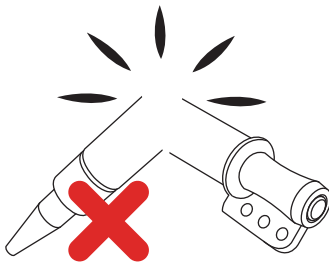

Do not break open Key

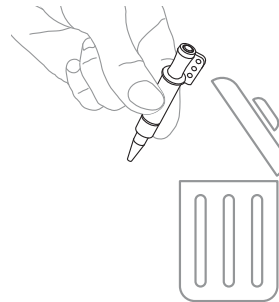

Throw Key away



- Do not break open Key when disposing.
- Throw away Key after test has completed.

LIMITATIONS

- The performance of the 3EO Health COVID-19 Test has not been evaluated with asymptomatic individuals. Individuals who are seeking to be tested for SARS-CoV-2 and who are not exhibiting symptoms should use an alternative test method that is authorized or cleared or approved for use in that population.
- The performance of this test was established based on the evaluation of a limited number of clinical specimens. Clinical performance has not been established with all circulating variants of SARS-CoV-2 but is anticipated to be reflective of the prevalent variants in circulation at the time and location of the clinical evaluation. Performance at the time of testing may vary depending on the variants circulating, including newly emerging strains of SARS-CoV-2 and their prevalence, which change over time.
- Sensitivity of the 3EO Health COVID-19 Test Kit™ may be affected by patient virus levels, other patient factors such as the presence of natural or synthetic reaction inhibitors, extensive mutations within the circulating SARS-CoV-2 virus, or incorrect sampling or handling.
- The 3EO Health COVID-19 Test Kit™ is not intended to detect other respiratory diseases or other infections, viral, bacterial, or fungal infections.
- It has been demonstrated that SARS-CoV-2 RNA may persist within COVID-19 patients for an extended time beyond the infectious period, resulting in continued positive tests.
- Do not use the 3EO Health COVID-19 Test Kit™ as the sole guide for making health management decisions. Always consider your complete health picture; discuss test results with your healthcare provider.
- The test is qualitative and does not quantify the amount of organism present.

Continued on next page >

LIMITATIONS

- Analytical testing showed the potential for invalid results to be reported in the presence of 0.5 mg/mL dexamethasone and 1% w/w fluconazole. Lower concentrations of these substances were not tested.
- Performance has been evaluated with 3EO Swab specimens only, using the procedures provided in this instruction. Failure to follow these procedures may lead to inaccurate test results.
- False negative results may occur if a specimen is improperly collected or handled.
- False negative results may occur if inadequate levels of virus are present in the specimen.
- False negative results may occur if the virus mutates significantly in the multiple regions targeted by the test.
- Cross-reactivity with respiratory tract organisms other than those tested in the Analytical Specificity Study may lead to erroneous results.
- False negative results may occur if the Swab is not inserted into the Key immediately after sample collection.
- False negative results may occur if the Cube is moved or tilted while the test is running.
- Failure to activate the 3EO Key as instructed in Step 1 can lead to false false negative, invalid, or test error results.
- ▶ If you forget to press the GREEN button within 60 minutes of inserting the Swab into the Key, you will need to retest. Remove the Key and Swab from the Cube. Start a new test with a new Key and a new Swab.
- Performance of the 3EO Health COVID-19 Test™ has only been established using the sample types, acquisition, and protocol described here.
- This device was not validated for use by individuals with color impaired vision including individuals with red/green vision impairment.

3EO HEALTH COVID-19 TEST PERFORMANCE

Limit of Detection (LoD) – Analytical Sensitivity

The preliminary LoD was determined by running the 3EO Health COVID-19 Test on contrived 3EO Swab samples in triplicate at 100, 80, 60, 50, 40 and 30 viral copies per 3EO Swab. Contrived 3EO Swab samples were immediately inserted into a 3EO Key and a test was run per the instructions. The lowest concentration at and above which all replicates returned a Positive result, the preliminary LoD, was 50 copies per 3EO Swab.

A confirmatory run at 50 copies per 3EO Swab was then conducted by running 20 replicates of the test at this virus concentration. This resulted in 17 out of 20 Positive results, which was below the 95% threshold for confirming the LoD. A trial at 55 copies per 3EO Swab resulted in 19 out of 20 (95%) Positive results.

Final LoD Determination Results

HI-SARS (genomic copies/Swab)	SARS-CoV-2 detection rate	% Detected
50	17/20	85%
55	19/20	95%

The claimed Limit of Detection is 55 copies of SARS-CoV-2 virus per 3EO swab.

3EO HEALTH COVID-19 TEST PERFORMANCE

Analytical Reactivity - Inclusivity

Inclusivity of the 3EO Health COVID-19 Test primer and probe sets was assessed to current and historical SARS-CoV-2 variants *in silico*. At least 3,000 complete, high-coverage SARS-CoV-2 genomic sequences were downloaded from the Global Initiative on Sharing All Influenza Data (GISAID) database (<https://www.gisaid.org>) for each quarter (3-month interval) from the beginning of the pandemic until present (four each for 2020-2022, plus Q1 and Q2 of 2023, totaling 14 quarterly sets and 52,547 sequences). Sequences were otherwise selected at random. The sequences for all 24 3EO primer/probe domains (i.e., 8 contiguous targetbinding sequence domains from each six-primer set, for each of three targets) were aligned to each quarterly subset of sequences. For each genome sequence, the number of primer sets (0, 1, 2, or 3) with a perfect match in every nucleotide of all eight domains was noted. In the absence of detailed mutation tolerance data, criteria for variant inclusivity was a 100% nucleotide match over at least one entire primer set of 6 strands.

This *in silico* analysis demonstrated a 100% nucleotide match to at least one primer set within 98.89 to 100% of sequences sampled in each of 14 quarters between January 2020 and June 2023.

3EO HEALTH COVID-19 TEST PERFORMANCE

Cross-Reactivity - Analytical Specificity

Analytical specificity of the 3EO Health COVID-19 Test was demonstrated by testing cross-reactivity with and interference from other organisms as well as endogenous substances.

Cross-Reactivity and Interference by Endogenous Substances – Wet Testing

A panel of endogenous and exogenous substances was added to SARS-CoV-2 Negative and low-Positive (3x LoD) contrived samples at or above concentrations expected in the testing environment. Possible interference was found with Dexamethasone (0.5mg/mL) and Diflucan (1% w/v). No other materials caused interference or false-Positive results at the concentrations tested.

Endogenous and Exogenous Interference Substance Studies Results

Interfering Substance	Final Concentration in Nasal Matrix	Negative Samples (#Negative / #Tested)	Positive Samples (#Positive / #Tested)	Cross Reactivity or Interference Observed
Afrin	20% v/v	3/3	3/3	No
Saline Nasal Spray	15% v/v (20% v/v)	3/3	3/3	No
Zicam Allergy Relief	2.5% v/v (10% v/v)	3/3	3/3	No
Chloraseptic Max	15% v/v (20% v/v)	3/3	3/3	No
Neo-Syneprine	20% v/v	3/3	3/3	No
Mucin	2.5 mg/mL	3/3	3/3	No
Mupirocin	10 mg/mL	3/3	3/3	No
Tamiflu (Oseltamivir phosphate)	0.01 mg/mL	3/3	3/3	No
Rhinocort (Budesonide)	15% v/v	3/3	3/3	No
Flunisolide	0.04 mg/mL	3/3	3/3	No
Dexamethasone	0.5 mg/mL	3/3**	3/3	Potential for interference observed
Tobramycin	2.5 mg/mL	3/3	3/3	No
Beclomethasone	0.068 mg/mL	3/3	3/3	No

3EO HEALTH COVID-19 TEST PERFORMANCE

Endogenous and Exogenous Interference Substance Studies Results

Interfering Substance	Final Concentration in Nasal Matrix	Negative Samples (#Negative / #Tested)	Positive Samples (#Positive / #Tested)	Cross Reactivity or Interference Observed
Biotin	1.75 mg/mL (3.5 mg/ml)	3/3	3/3	No
Xofluza (Baloxavir marboixil)	0.01 mg/mL	3/3	3/3	No
Nasacort (Triamcinolone)	20% v/v	3/3	3/3	No
Flonase (Fluticasone)	10% v/v (15% v/v)	3/3	3/3	No
Mometasone	0.04 mg/mL	3/3	3/3	No
Whole Blood	5% v/v	3/3	3/3	No
Chloraseptic (solid)	20% w/v	3/3	3/3	No
Galphimia Glauca	15% w/v (20% w/v)	3/3	3/3	No
Rhinallergy	20% w/v	3/3	3/3	No
Diflucan	1% w/v	3/3**	3/3	Potential for interference observed
Method All-Purpose Cleaner	0.5% v/v (1% v/v)	3/3	3/3	No
Seventh Generation Disinfectant	5% v/v	3/3	3/3	No
Cepacol	3 mg/mL	3/3	3/3	No
NeilMed Nasal Gel	1.25% v/v	3/3	3/3	No
Robitussin	5% v/v	3/3	3/3	No

* Values in parentheses showed potential interference. These substances were diluted to the values shown without parentheses and retested to yield expected results.

** One invalid test required a retest and returned an expected result.

3EO HEALTH COVID-19 TEST PERFORMANCE

Cross-Reactivity from Microbes – *in silico* Testing

A panel of 31 bacteria and viruses identified as common nasal flora were screened *in silico* for potential sequence-based cross-reactivity to the 3EO Health COVID-19 Test. Analyses identified which genomic sequences have greater than 80% similarity to any primer. Genomic sequences for the 31 microbes were downloaded from available databases (GISAID, NMSX, GenBank). All 24 3EO Health SARS-CoV-2 assay primer domains (8 domains each from 3 sets of 6 primers) were evaluated for similarity to the genomic sequences for all microbes.

Sequence Homology Results

Organism Tested	Sequence Similarity Score*
Pseudomonas aeruginosa	no alignment found
Legionella pneumophila	no alignment found
Staphylococcus epidermis	no alignment found
Streptococcus pyogenes	no alignment found
Enterovirus (EV68)	no alignment found
Pneumocystis jirovecii (PJP) – S. cerevisiae Recombinant	no alignment found
Adenovirus (Type C1)	no alignment found
Human Metapneumovirus (hMPV)	no alignment found
Influenza A H1N1	no alignment found
Influenza B Victoria	no alignment found
Parainfluenza virus 1	no alignment found
Parainfluenza virus 2	no alignment found
Parainfluenza virus 3	no alignment found
Parainfluenza virus 4A	no alignment found
Respiratory syncytial virus -Type A	no alignment found
Rhinovirus (Type 1A)	no alignment found

3EO HEALTH COVID-19 TEST PERFORMANCE

Sequence Similarity Results

Organism Tested	Sequence Similarity Score*
Bordetella pertussis	no alignment found
Chlamydia pneumoniae	no alignment found
Mycoplasma pneumoniae	no alignment found
Staphylococcus aureus	no alignment found
Streptococcus pneumoniae	no alignment found
Candida albicans	85.2%
Mycobacterium tuberculosis	no alignment found
Haemophilus influenzae	no alignment found
Streptococcus salivarius	83.4%
SARS-coronavirus (Select Agent)	100%
Human coronavirus 229E	no alignment found
Human coronavirus OC43	no alignment found
Human coronavirus HKU1	no alignment found
Human coronavirus NL63	no alignment found
MERS-coronavirus-BSL3	no alignment found

* The maximum individual sequence similarity score among all (24) primer domains is noted. 'No alignment found' indicates a maximum score of less than 80%, expected to be non-reactive. Note that matches with other, less similar domains are also necessary for reactivity.

The calculated similarity score for each of the tested organisms, with the exceptions of SARS-CoV with high similarity to the E primer set, as well as a single domain each at > 80% score for Streptococcus salivarius and Candida albicans, fell below 80%. All passed wet lab cross-reactivity testing as described in the next section.

3EO HEALTH COVID-19 TEST PERFORMANCE

Cross-Reactivity and Interference by Microbes – Wet Testing

A panel of 32 bacteria, viruses, or matrices were tested for interference (false Negative or Invalid results) or cross reactivity (false Positive results) in the 3EO Health COVID-19 Test. Each microbe or matrix was added to SARS-CoV-2 Negative and low-Positive contrived samples at high concentration. Any substances that resulted in interference in the assay were diluted and retested until passing. Positive and Negative tests were run for all conditions in triplicate.

None of the 32 organisms or matrix samples resulted in cross-reactivity (false Positives) with the 3EO Health COVID-19 Test at the concentrations tested – even those with *in silico* homology as high as SARS-CoV. The microbes also did not lead to false Negative results (interfere with SARS-CoV-2 in low-Positive trials) or Invalid results (interfere with control amplification in Positive or Negative trials) at the concentrations tested.

Microbial Interference and Cross-Reactivity Results

Organism Tested	Concentration Tested (per mL of spike)	# Pos / # Tested	# Neg / # Tested
Pseudomonas aeruginosa	1.82 x 10 ⁹ CFU/mL	3/3	3/3
Legionella pneumophila	1.05 x 10 ⁹ CFU/mL	3/3	3/3
Staphylococcus epidermis	3.04 x 10 ⁸ CFU/mL	3/3	3/3
Streptococcus pyogenes	3.82 x 10 ⁸ CFU/mL	3/3	3/3
Enterovirus Type 68	7.10 x 10 ⁴ TCID50/mL	3/3	3/3
Pneumocystis jirovecii (PJP) – S. cerevisiae Recombinant	3.3 x 10 ⁷ CFU/mL	3/3	3/3
Adenovirus - Type C1	3.09 x 10 ⁷ TCID50/mL	3/3	3/3
Human Metapneumovirus (hMPV)	2.52 x 10 ⁵ TCID50/mL	3/3	3/3
Influenza A H1N1 (Brisbane/59/07)	8.34 x 10 ⁴ TCID50/mL	3/3	3/3
Influenza B Victoria (Colorado/6/17)	2.82 x 10 ⁴ TCID50/mL	3/3	3/3
Parainfluenza virus 1	2.52 x 10 ⁵ TCID50/mL	3/3	3/3
Parainfluenza virus 2	8.34 x 10 ⁴ TCID50/mL	3/3	3/3
Parainfluenza virus 3	5.64 x 10 ⁶ TCID50/mL	3/3	3/3
Parainfluenza virus 4A^	2.30 x 10 ⁶ TCID50/mL	3/3	3/3
Respiratory syncytial virus -Type A	2.34 x 10 ⁴ TCID50/mL	3/3	3/3
Rhinovirus (Type 1A)	2.82 x 10 ⁴ TCID50/mL	3/3	3/3

3EO HEALTH COVID-19 TEST PERFORMANCE

Microbial Interference and Cross-Reactivity Results

Organism Tested	Concentration Tested (per mL of spike)	# Pos / # Tested	# Neg / # Tested
Bordetella pertussis	3.92 x 10 ⁹ CFU/mL	3/3	3/3
Chlamydia (Chlamydophila) pneumoniae	5.34 x 10 ⁷ CFU/mL	3/3	3/3
Mycoplasma pneumoniae	5.40 x 10 ⁷ CCU/mL	3/3	3/3
Staphylococcus aureus	5.02 x 10 ⁸ CFU/mL	3/3	3/3
Streptococcus pneumoniae	2.68 x 10 ⁸ CFU/mL	3/3	3/3
Candida albicans	1.12 x 10 ⁸ CFU/mL	3/3	3/3
Mycobacterium tuberculosis	2.42 x 10 ⁷ CFU/mL	3/3	3/3
Haemophilus influenzae	7.74 x 10 ⁷ CFU/mL	3/3	3/3
Streptococcus salivarius	2.7 x 10 ⁸ CFU/mL	3/3	3/3
SARS-CoV*	5-fold dilution of 26.5 Ct stock	3/3	3/3
Human coronavirus 229E	2.82 x 10 ⁴ TCID50/mL	3/3	3/3
Human coronavirus OC43	2.10 x 10 ⁵ TCID50/mL	3/3	3/3
Human coronavirus HKU1**	1.1 x 10 ⁵ genome copies/mL	3/3	3/3
Human coronavirus NL63^^	7.10 x 10 ⁴ TCID50/mL	3/3	3/3
MERS-coronavirus	2.10 x 10 ⁵ TCID50/mL	3/3	3/3
Pooled human nasal wash	20% v/v	3/3	3/3

* Heat-inactivated.

** Synthetic RNA sequence; full virus was not available.

^ One invalid test required a retest due to manufacturing or procedural errors, and returned an expected result.

^^ Two Invalid tests required retests due to manufacturing or procedural errors, and returned expected results.

3EO HEALTH COVID-19 TEST PERFORMANCE

Human Usability and Comprehension of Test Results

Usability

3EO Health conducted a human usability and comprehension of test results study to demonstrate overall usability by home users (individual tester or tester/donor pair) with no medical background or laboratory training and who would be operating the device in a home environment. The usability evaluation included 59 representative users of one user population: home users with no medical background or laboratory training. Within this user population, users were sub-divided into 2 groups: 1) Lay users at least 14 years old testing themselves, and 2) adults testing another adult/child. Fifteen (15) users in Group 1 were recruited and 44 users in Group 2 were recruited. In order to evaluate both the test workflow usability and ability of the user to read and comprehend each of the possible 3EO Cube Result outputs, two Use Case scenarios were evaluated:

- a) Use Case 1: Evaluated each user performing the test on themselves or a separate donor as described. The QSG was provided as instructions for the test, without additional feedback from the test observer. Those with smart phones had the option of using the QR code displayed in the QSG for a video guide. All test materials were provided in the packaged / disconnected / default conditions. Both the participant and observer completed forms to evaluate their ability to complete each task and to document users' feedback.
- b) Use Case 2: Evaluated the ability of users to read and accurately interpret each of the possible test results displayed by the 3EO Cube (i.e., Positive, Negative, Invalid, and Test Error). Users were asked to view, one at a time, each of the four possible 3EO Cube results and to interpret and record each result. Both the participant and observer completed forms to evaluate their ability to read/ comprehend each test result and to document users' feedback.

In both Use Case 1 (Usability) and Use Case 2 (Comprehension of Test Results), 100% of essential tasks were completed successfully for both lay users testing themselves and assisted tests by a lay user. In Use Case 2 (Comprehension of Test Results), 100% of lay users correctly interpreted the results.

3EO HEALTH COVID-19 TEST PERFORMANCE

Usability and Comprehension of Test Results

On participant feedback questionnaires, users rated the product favorably in terms of ease of use. They rated the product and user documentation well in nine essential metrics for Use Case 1 and twelve essential metrics for Use Case 2.

3EO HEALTH COVID-19 TEST PERFORMANCE

Clinical Evaluation

3EO Health conducted a prospective, “all-comers,” multi-center study to evaluate the 3EO Health COVID-19 Test. Lay users with symptoms of COVID-19 collected fresh samples, tested for SARS-CoV-2 RNA, and interpreted results, all by following the 3EO Health QSG in a simulated home environment. A high sensitivity molecular FDA Authorized SARSCoV- 2 comparator assay test sample was collected and evaluated by a third-party laboratory.

A total of 202 participants were prospectively enrolled and completed the 3EO Health COVID-19 Test. Among those tested, 197 returned a valid 3EO result (overall Valid Test Rate 197/202 = 97.5%). Two of the 197 returned invalid comparator results and were excluded from analysis. The remaining 195 test pairs were used to calculate clinical evaluation results. When compared to a high sensitivity molecular FDA authorized SARSCoV- 2 assay, the total Positive Percent Agreement (PPA) across all samples was 95% (38/40).

Clinical Evaluation Results

		Molecular FDA Authorized SARS-CoV-2 Assay		
		Positive	Negative	Total
3EO Health COVID-19 Test	Positive	38	0	38
	Negative	2	155	157
	Total	40	155	195
		PPA = 38/40 = 95.0% (95% CI 83.5 - 98.6%)	NPA = 155/155 = 100.0% (95% CI 97.6 - 100%)	

CLEANING YOUR CUBE

- After each use, wipe the outer surfaces of the Cube with germicidal wipes or equivalent containing 0.55% sodium hypochlorite as the active ingredient.
- Cleaning after each use is necessary to prevent cross-contamination between users.

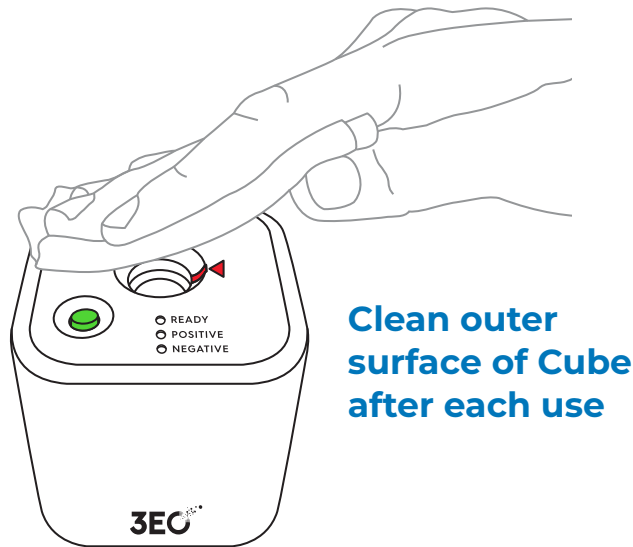

TROUBLESHOOTING

Scenario

Possible Explanation(s)

The READY light does not display after inserting the Key into the Cube

- Make sure the Key is fully inserted
- Make sure the Key is a 3EO Health™-issued product (no other consumables are compatible)

The LED display indicates an invalid test result (alternating positive and negative lights flashing)

- An Invalid Result is likely due to a problem with the test preparation, such as improper Key activation, inadequate sample collection, or failure to press the Key flat when inserting into the Cube.
- The user did not perform all test procedures in accordance with the IFU and/or User Manual
- The Cube was moved or tampered with during sample processing.
- See page 31 for instructions on how to retest

The LED display indicates a test error (all lights flashing)

- A Test Error result is likely due to a problem with the test equipment, such as Cube power interruption, Cube mechanical failure, or a defective Key.
- See page 31 for instructions on how to retest

FREQUENTLY ASKED QUESTIONS

Question

Answer

Can the Cube be transported to multiple locations?

The Cube can be transported to multiple locations without revalidation. Do not move the Cube while a test is in process.

Can I move the Cube while a test is in process?

No. Do not move or tilt the Cube while a test is in process.

What should I do if my system loses power during a test?

If the Cube loses connection to power during a test, remove the consumable and restart the test procedure with a new consumable and sample.

Where can I purchase 3EO Health™ tests?

3EO Health™ tests are available for over-the-counter purchase. Visit 3EOHealth.com for more information about purchasing new tests or other supplies.

What should I do if I forget to press the GREEN button to start my test?

If it has been 60 minutes or more, remove the Key and start a new test with a new Key and Swab.

If it has been less than 60 minutes, press and hold the GREEN button until the READY light starts flashing.

FREQUENTLY ASKED QUESTIONS

Question

Answer

Other than 3EO Health™ consumables, are there any other supplies that I need to purchase with my Cube?

For tests that required the results to be reported to public health authorities, you must have access to a mobile device with a QR scanner.

How often should I clean the Cube?

Clean the Cube after each use with Germicidal Wipes or equivalent containing 0.55% sodium hypochlorite as the active ingredient.

Does the Cube require any professional servicing or maintenance?

No. The Cube does not require professional servicing. If your Cube has technical issues, contact care@3EOHealth.com or 1-844-LETS-3EO (1-844-538-7336).

TECHNICAL INFORMATION

Dimensions	68.5 mm wide x 68.5 mm deep x 72 mm high
Weight	165 g
Input Power	12VDC @ 1.5 A max (only use the power adapter included with the 3EO Cube™)
Operating Temperature Range	59°F to 86°F (15°C to 30°C)
Operating Humidity Range	10% to 90%
Operational Altitude	< 6500 ft (1980 m)
Storage Temperature Range	59°F to 86°F (15°C to 30°C)
Storage Humidity Range	10% to 90%
Storage Altitude	< 6500 ft (1980 m)
Operating Environment	Indoor Use Only

Continued on next page >

TECHNICAL INFORMATION

Manufacturer's Declaration - Electromagnetic Emissions Compliance

Emission Test	Compliance
RF Radiated Emissions CISPR 11 Ed 5.0 (with A1:2010)	Group 1 Class B
RF Conducted Emissions CISPR 11 Ed 5.0 (with A1:2010)	Group 1 Class B
Harmonic Emissions IEC 61000-3-2 Ed 5.1 (2020)	Class A
Voltage fluctuations/ flicker emissions IEC 61000-3-3 Ed 3.0 (2013-05)	Complies, Dmax = 4%

Manufacturer's Declaration - Electromagnetic Immunity to RF Wireless Communications Equipment

Immunity Test	Test Level	Compliance Level
IEC 60601-1-2 Ed 4.0 Table 9	385 MHz, 27 V/m	385 MHz, 27 V/m
	450 MHz, 28 V/m	450 MHz, 28 V/m
	710, 745, 780 MHz, 9 V/m	710, 745, 780 MHz, 9 V/m
	810, 870, 930 MHz, 28 V/m	810, 870, 930 MHz, 28 V/m
	1720, 1845, 1970 MHz, 28 V/m	1720, 1845, 1970 MHz, 28 V/m
	2450 MHz, 28 V/m	2450 MHz, 28 V/m
	5240, 5500, 5785 MHz, 9 V/m	5240, 5500, 5785 MHz, 9 V/m

Continued on next page >

TECHNICAL INFORMATION

Manufacturer's Declaration - Electromagnetic Immunity Compliance

Immunity Test	Test Level	Compliance Level
Electro-Static Discharge Immunity IEC 61000-4-2 Ed 2.0 (2008-12)	+/- 8kV contact +/- 2kV,+/- 4kV,+/- 8kV,+/- 15kV air	+/- 8kV contact +/- 2kV,+/- 4kV,+/- 8kV,+/- 15kV air
Radiated, Radio-Frequency, Electromagnetic Immunity IEC 61000-4-3 Ed 3.0 (with A1:2007+A2:2010)	10 V/m (80% AM @ 1kHz) 80-2700 MHz	10 V/m (80% AM @ 1kHz) 80-2700 MHz
Conducted, Radio-Frequency Electromagnetic Immunity IEC 61000-4-6 Ed 4.0 (2013)	3 Vrms (80% AM @ 1kHz) 150kHz - 80MHz 6Vrms (80% AM @ 1kHz) ISM and Amateur Bands	3 Vrms (80% AM @ 1kHz) 150kHz - 80MHz 6Vrms (80% AM @ 1kHz) ISM and Amateur Bands
Electrical Fast Transient/Burst Immunity IEC 61000-4-4 Ed 3.0 (2012-04)	+/- 2kV 100kHz repetition frequency for power supply lines	+/- 2kV 100kHz repetition frequency for power supply lines
Immunity to Surges IEC 61000-4-5 Ed 2.0 (2005)	+/- 0.5 kV, +/- 1kV line to line	+/- 0.5kV, +/- 1kV line to line
Power Frequency Magnetic Field Immunity IEC 61000-4-8 Ed .20 (2004-03)	30 A/m, 50/60 Hz	30 A/m, 50/60 Hz
Voltage Dips/Interruptions Immunity IEC 61000-4-11 Ed 2.0 (2004-03)	0% UT for 0.5 cycle at 0°,45°,90°,135°,180°,225°,270° and 315° for 50 and 60 Hz 0% UT for 1 cycle at 0° for 50 and 60 Hz 70% UT for 25 cycles at 0° for 50 Hz 70% UT for 30 cycles at 0° for 60 Hz 0% UT for 250 cycles at 0° for 50 Hz 0% UT for 300 cycles at 0° for 60 Hz	0% UT for 0.5 cycle at 0°,45°,90°,135°,180°,225°,270° and 315° for 50 and 60 Hz 0% UT for 1 cycle at 0° for 50 and 60 Hz 70% UT for 25 cycles at 0° for 50 Hz 70% UT for 30 cycles at 0° for 60 Hz 0% UT for 250 cycles at 0° for 50 Hz 0% UT for 300 cycles at 0° for 60 Hz

Continued on next page >

TECHNICAL INFORMATION

Compliance with International Product Safety Standards

The 3EO Cube has been tested and found to be in compliance with the following Product Safety standards:

Product Safety:

- UL 61010-1:2012 3rd Edition + R:19Jul2019
- UL 61010-2-101:2019 3rd Edition
- CSA C22.2#61010-1-12:2012 3rd Edition +U1;U2:A1
- CSA C22.2#61010-2-101:2019 3rd Edition
- EN 61010-1:2010+A1
- EN 61010-2-101:2017



- Conforms to UL STDs 61010-1, 61010-2-101, & 61010-2-010
- Certified to CSA STDs C22.2# 60601-1-12, 61010-2-101, & 61010-2-010

CUBE DISPOSAL













The 3EO Cube is reusable and intended for multiple uses.

If disposal is required, dispose of according to applicable regulations in your state, territory, or country.

For information about the correct method of disposal, contact your local authorities.

SYMBOLS

The following symbols are found on the 3EO Cube and/or its packaging and labeling:

Symbol	Description
	In Vitro Diagnostic
	Consult Instructions for Use
	Serial Number
	Caution: Indicates the need for the user to consult the instructions for use for important cautionary information such as warnings and precautions that cannot, for a variety of reasons, be presented on the medical device itself.
	Do not use if packaging is damaged
	Storage Temperature Range
	Humidity Limitation
	Model Number
	Manufacturer
	Keep Dry
	Use By
	Date of Manufacture

CUSTOMER SUPPORT

For troubleshooting and frequently asked questions, please visit:

<https://3EOHealth.com>

Or, contact us:

3EO Health Inc.

48 Dunham Ridge Rd.

Suite 4350

Beverly, MA 01915

1-844-LETS-3EO (1-844-538-7336)

care@3EOHealth.com

This product has not been FDA cleared or approved, but has been authorized for emergency use by FDA under an Emergency Use Authorization (EUA).

This product has been authorized only for the detection of nucleic acid from SARS-CoV-2, not for any other viruses or pathogens.

The emergency use of this product is only authorized for the duration of the declaration that circumstances exist justifying the authorization of emergency use of in vitro diagnostics for detection and/or diagnosis of COVID-19 under section 564(b)(1) of the Federal Food, Drug and Cosmetic Act, 21 U.S.C. §360bb-3(b)(1), unless the declaration is terminated or authorization is revoked sooner.